



Cisco C880 M5 Storage Subsystem Operating Manual

November 2017

Americas Headquarters

Cisco Systems, Inc.
170 West Tasman Drive
San Jose, CA 95134-1706 USA
<http://www.cisco.com>
Tel: 408 526-4000
800 553-NETS (6387)
Fax: 408 527-0883

THE SPECIFICATIONS AND INFORMATION REGARDING THE PRODUCTS IN THIS MANUAL ARE SUBJECT TO CHANGE WITHOUT NOTICE. ALL STATEMENTS, INFORMATION, AND RECOMMENDATIONS IN THIS MANUAL ARE BELIEVED TO BE ACCURATE BUT ARE PRESENTED WITHOUT WARRANTY OF ANY KIND, EXPRESS OR IMPLIED. USERS MUST TAKE FULL RESPONSIBILITY FOR THEIR APPLICATION OF ANY PRODUCTS.

THE SOFTWARE LICENSE AND LIMITED WARRANTY FOR THE ACCOMPANYING PRODUCT ARE SET FORTH IN THE INFORMATION PACKET THAT SHIPPED WITH THE PRODUCT AND ARE INCORPORATED HEREIN BY THIS REFERENCE. IF YOU ARE UNABLE TO LOCATE THE SOFTWARE LICENSE OR LIMITED WARRANTY, CONTACT YOUR CISCO REPRESENTATIVE FOR A COPY.

The Cisco implementation of TCP header compression is an adaptation of a program developed by the University of California, Berkeley (UCB) as part of UCB's public domain version of the UNIX operating system. All rights reserved. Copyright © 1981, Regents of the University of California.

NOTWITHSTANDING ANY OTHER WARRANTY HEREIN, ALL DOCUMENT FILES AND SOFTWARE OF THESE SUPPLIERS ARE PROVIDED "AS IS" WITH ALL FAULTS. CISCO AND THE ABOVE-NAMED SUPPLIERS DISCLAIM ALL WARRANTIES, EXPRESSED OR IMPLIED, INCLUDING, WITHOUT LIMITATION, THOSE OF MERCHANTABILITY, FITNESS FOR A PARTICULAR PURPOSE AND NONINFRINGEMENT OR ARISING FROM A COURSE OF DEALING, USAGE, OR TRADE PRACTICE.

IN NO EVENT SHALL CISCO OR ITS SUPPLIERS BE LIABLE FOR ANY INDIRECT, SPECIAL, CONSEQUENTIAL, OR INCIDENTAL DAMAGES, INCLUDING, WITHOUT LIMITATION, LOST PROFITS OR LOSS OR DAMAGE TO DATA ARISING OUT OF THE USE OR INABILITY TO USE THIS MANUAL, EVEN IF CISCO OR ITS SUPPLIERS HAVE BEEN ADVISED OF THE POSSIBILITY OF SUCH DAMAGES.

Cisco and the Cisco logo are trademarks or registered trademarks of Cisco and/or its affiliates in the U.S. and other countries. To view a list of Cisco trademarks, go to this URL: www.cisco.com/go/trademarks. Third-party trademarks mentioned are the property of their respective owners. The use of the word partner does not imply a partnership relationship between Cisco and any other company. (1110R)

Any Internet Protocol (IP) addresses used in this document are not intended to be actual addresses. Any examples, command display output, and figures included in the document are shown for illustrative purposes only. Any use of actual IP addresses in illustrative content is unintentional and coincidental.

© 2017 Cisco Systems, Inc. All rights reserved.

Before reading this manual

For your safety

This manual contains important information for safely and correctly using this product.

Carefully read the manual before using this product. Pay particular attention to the accompanying manual "Safety notes and other important information" and ensure these safety notes are understood before using the product.

Keep this manual and the manual "Safety notes and other important information" in a safe place for easy reference while using this product.

Radio interference

This product is a "Class A" ITE (Information Technology Equipment) as defined by the Voluntary Control Council for Interference by Information Technology Equipment (VCCI-A) of Japan. In a domestic environment this product may cause radio interference, in which case the user may be required to take appropriate measures.

Aluminum electrolytic capacitors

The aluminum electrolytic capacitors used in the product's printed circuit board assemblies and in the mouse and keyboard are limited-life components. Use of these components beyond their operating life may result in electrolyte leakage or depletion, potentially causing emission of foul odor or smoke.

As a guideline, in a normal office environment (25°C) operating life is not expected to be reached within the maintenance support period (5 years). However, operating life may be reached more quickly if, for example, the product is used in a hot environment. The customer shall bear the cost of replacing replaceable components which have exceeded their operating life. Note that these are only guidelines, and do not constitute a guarantee of trouble-free operation during the maintenance support period.

High safety use

This product has been designed and manufactured for general uses such as general office use, personal use, domestic use and normal industrial use. It has not been designed or manufactured for uses which demand an extremely high level of safety and carry a direct and serious risk to life or body if such safety cannot be ensured.

These uses include control of nuclear reactions in nuclear power plants,

automatic airplane flight control, air traffic control, traffic control in mass transport systems, medical devices for life support, and missile guidance control in weapons systems (hereafter, “high safety use”). Customers should not use this product for high safety use unless measures are in place for ensuring the level of safety demanded of such use. Please consult the sales staff if intending to use this product for high safety use.

Measures against momentary voltage drop

This product may be affected by a momentary voltage drop in the power supply caused by lightning. To prevent a momentary voltage drop, use of an AC uninterruptible power supply is recommended.

Contents



Cisco C880 M5 Storage Subsystem Operating Manual

<u>1.</u>	<u>Introduction</u>	<u>7</u>
1.1.	Notation Conventions	7
1.2.	Technical Data	7
<u>2.</u>	<u>Important Notes</u>	<u>9</u>
2.1.	Notes on Safety.....	9
2.2.	Electrostatic-sensitive Component Label	11
2.3.	CE Certificate	12
2.4.	FCC Class A Compliance Statement	12
2.5.	Notes on Mounting the Rack.....	13
2.6.	Notes on Transportation	13
<u>3.</u>	<u>Installation</u>	<u>14</u>
3.1.	Installation Steps.....	14
3.2.	Unpacking the Storage Subsystem	15
3.3.	Installing the Storage Subsystem in the Rack.....	15
3.3.1.	Requirements of the Rack	16
3.3.2.	Rack mounting	16
3.4.	Switching the Storage Subsystem ON/OFF.....	20
<u>4.</u>	<u>Operating and Indicator Elements</u>	<u>21</u>
4.1.	Front Side.....	21
4.1.1.	Operation Panel	22
4.1.2.	Disk LEDs	23
4.1.3.	I/O Module	25
4.1.4.	Power Supply Unit (PSU)	27
<u>5.</u>	<u>Hard Disk Drives</u>	<u>28</u>
5.1.	Handling Hard Disk Drives	28
5.2.	Removing/Installing Hard Disk Drive/Drive Dummy	29
<u>6.</u>	<u>Connections</u>	<u>32</u>

6.1.	SAS Connection.....	32
6.2.	Power Supply Connection	34
7.	<u>Configurations</u>	<u>35</u>
7.1.	RAID controller / HBA configuration and maximal storage configuration	36
7.2.	RAID controller / HBA configuration with two way storage	37
7.2.1.	Host Bus Adapter.....	37
7.3.	Redundant controller and storage two way configuration.....	38
7.4.	Redundant controller and storage with file sharing	39
8.	<u>Fault Clearing</u>	<u>40</u>
8.1.	Problem Solutions and Tips	41
8.1.1.	Identification LED (Front)	41
8.1.2.	Fault LED (Front).....	41
8.1.3.	Power LED (Front)	41
8.1.4.	I/O Module (IOM)	42
8.1.5.	Temperature Sensor Error Message	42
8.1.6.	Error LED of the Hard Disk Drive Indicates Disk Failure	42
8.1.7.	The Storage Subsystem does not Power on with the Attached Server	43
9.	<u>Replacing Components</u>	<u>44</u>
9.1.	Power Supply Unit	44
9.2.	I/O Module.....	46
9.3.	Operation Panel	47
	<u>Abbreviations</u>	<u>50</u>

1. Introduction

1.1. Notation Conventions

<i>Italics</i>	identifies commands and entries in flow text
Semibold	highlights text
“Quotation marks”	indicates references to other chapters or manuals
➤	identifies an operation that you have to perform
	indicates additional information, notes and tips
	indicates warnings, which, if ignored, will endanger your health, the operability of your server or the security of your data

1.2. Technical Data

Installation specification	
19" rackmount	2 U (height units)
Dimension (W x D x H)	2.5": 482 x 540 x 88 mm
Weight	35 kg (depending on the number of disks installed)
Service area	Front: 850 mm or more Rear: 850 mm or more
Power voltage	AC 100 - 120 V/ AC 200 - 240 V
Power frequency	50 / 60 Hz
Maximum power consumption	2.5": 430 W (440 VA)
Power supply efficiency	92 %
No. of PSUs / power phase	2 PSUs, full redundant / phase redundancy possible

Environmental	
Maximum heat generation	2.5": 1600 kJ/h (1517 btu/h)
Temperature (operating)	10 to 35°C
Temperature (not operating)	0 to 50°C
Temperature gradient	15°C/Hr or less
Humidity (operating)	20 – 80 % relative humidity, non-condensing
Humidity (not operating)	8 – 80 % relative humidity, non-condensing
Humidity gradient	30 %/day or less
Altitude	3,000 m
Sound power (LWAd; 1B = 10dB)	6.0 B
Sound pressure (LpAm)	43.5 db(A)
Noise notes	measured according to ISO7779 and declared according to ISO9296

Compliance	
Product safety	UL 60950-1, CSA-C22.2 No. 60950-1, EN 60950-1, IEC 60950-1
Electromagnetic compatibility	CNS 13438, FCC Part-15 Class A, ICES 003 Class A, EN 55022 Class A, VCCI Class A, AS/NZS CISPR 22 Class A
CE certification	2004/108/EC, 2006/95/EC, 2011/65/EC
Approvals	CB, CE, RCM, FCC, VCCI
Environmental compliance	RoHS compliant, WEEE compliant
Compliance notes	There is general compliance with the safety requirements of all European countries and North America. National approvals required in order to satisfy statutory regulations or for other reasons can be applied for on request.

2. Important Notes

2.1. Notes on Safety

In this section you will find information that you must note when using the storage subsystem.

This device complies with the relevant safety standards for IT equipment.

If you have any questions relating to setting up and operating your system in the environment where you intend to use it, please contact your sales outlet or our customer service team.



CAUTION!

- The actions described in these instructions should only be performed by technical specialists. Equipment repairs should only be performed by service personnel. Any unauthorized openings and improper repairs could expose the user to risks (electric shock, energy hazards, fire hazards) and could also damage the equipment. Please note that any unauthorized openings of the device will result in the invalidation of the warranty and exclusion from all liability.
- Transport the device in its original packaging or in other suitable packaging which will protect it against shock or impact.
- Read the notes on environmental conditions in [section "Technical Data" on page 7](#) before setting up and operating the device.
- If the device is brought in from a cold environment, condensation may form both inside and on the outside of the machine.
- Wait until the device has acclimatized to room temperature and is absolutely dry before starting it up. Material damage may be caused to the device if this requirement is not observed.
- Check that the rated voltage specified on the type label is the same as the local line voltage.

**CAUTION!**

- The device must only be connected to a properly grounded wall outlet (the device is fitted with a tested and approved power cable).
- Make sure that the power sockets on the device and the protective grounded outlet of the building's wiring system is freely accessible.
- Switching off the device does not cut off the supply of power. To do this you must remove the power plugs.
- Before opening the unit, switch off the device and then pull out the power plugs.
- Route the cables in such a way that they do not form a potential hazard (make sure no-one can trip over them) and that they cannot be damaged. When connecting up a device, refer to the relevant notes in this manual.
- Never connect or disconnect data transmission lines during a storm (lightning hazard).
- Systems which comprise a number of cabinets must use a separate fused socket for each cabinet.
- The servers and the directly connected external storage subsystems should be connected to the same power supply distributor. Otherwise you run the risk of losing data if, for example, the central processing unit is still running but the storage subsystem has failed during a power failure.
- Make sure that no objects (such as bracelets or paper clips) fall into or liquids spill into the device (risk of electric shock or short circuit).
- In emergencies (e.g. damage to housings, power cords or controls or ingress of liquids or foreign bodies), immediately power down the device, pull out the power plugs and notify your service department.
- Note that proper operation of the system (in accordance with IEC 60950-1/DIN EN 60950-1) is guaranteed only if slot covers are installed on all vacant slots and/or dummies on all vacant bays and the housing cover is fitted (cooling, fire protection, RFI suppression).

2.2. Electrostatic-sensitive Component Label

Electrostatic-sensitive components may be identified by the following sticker:



Figure 1: Electrostatic-sensitive component sticker

- You must follow the instructions below when handling modules containing electrostatic-sensitive components
- Discharge static electricity from your body (for example by touching a grounded metal object) before handling modules containing electrostatic-sensitive components.
- The equipment and tools you use must be free of static charge.
- Remove the power plug before installing or removing modules containing electrostatic-sensitive components.
- Only hold modules containing electrostatic-sensitive components by their edges.
- Do not touch any of the pins or track conductors on a module containing electrostatic-sensitive components.
- Use a grounding strap designed for the purpose, to connect you to the system unit as you install the modules.
- Place all components on a static-safe base.



An exhaustive description of the handling of modules containing electrostatic-sensitive components can be found in the relevant European and international standards (DIN EN 61340-5-1, ANSI/ESD S20.20).

2.3. CE Certificate



The system complies with the requirements of the EC directives 2004/108/EC regarding "Electromagnetic Compatibility" and 2006/95/EC "Low Voltage Directive" and the directive of the European Parliament and Council 2011/65/EU. This is indicated by the CE marking (CE = Communauté Européenne).

2.4. FCC Class A Compliance Statement

If there is an FCC statement on the device, it applies to the products covered in this manual, unless otherwise specified herein. The statement for other products will appear in the accompanying documentation.



This equipment has been tested and found to comply with the limits for a "Class A" digital device, pursuant to Part 15 of the FCC rules and meets all requirements of the Canadian Interference-Causing Equipment Standard ICES-003 for digital apparatus. These limits are designed to provide reasonable protection against harmful interference in a residential installation. This equipment generates, uses and can radiate radio frequency energy and, if not installed and used in strict accordance with the instructions, may cause harmful interference to radio communications. However, there is no warranty that interference will not occur in a particular installation. If this equipment does cause harmful interference to radio or television reception, which can be determined by turning the equipment off and on, the user is encouraged to try to correct the interference by one or more of the following measures:

- Reorient or relocate the receiving antenna.
- Increase the separation between equipment and the receiver.
- Connect the equipment into an outlet on a circuit different from that to which the receiver is connected.
- Consult the dealer or an experienced radio/TV technician for help.

We are not responsible for any radio or television interference caused by unauthorized modifications of this equipment or the substitution or attachment of connecting cables and equipment other than those specified by us. The correction of interferences caused by such unauthorized modification, substitution or attachment will be the responsibility of the user. The use of shielded I/O cables is required when

connecting this equipment to any and all optional peripheral or host devices. Failure to do so may violate FCC and ICES rules.

W WARNING

This is a class A product. In a domestic environment this product may cause radio interference in which case the user may be required to take adequate measures.

2.5. Notes on Mounting the Rack

- For safety reasons, at least two people are required to install the rack-mounted model because of its weight and size.
- Ensure that the anti-tilt bracket is correctly mounted when you set up the rack.
- For safety reasons, no more than one unit may be withdrawn from the rack at any one time during installation and maintenance work. There is a danger that the rack will tilt forward.
- The power supply to the rack must be installed by an authorized specialist (electrician).

2.6. Notes on Transportation



Transport the storage subsystem in its original packaging or in other suitable packaging which will protect it against shock or impact. Do not unpack it until all transport maneuvers are completed.

If you need to lift or transport the storage subsystem, ask someone to help you.

3. Installation

3.1. Installation Steps



CAUTION!

The storage subsystem should not be subjected to any extreme environmental conditions (see [section "Technical Data" on page 7](#)). Protect it from dust, moisture and heat.

The following installation steps are described in detail in other sections of this chapter:

- Unpacking the storage subsystem.
- Inserting the storage subsystem into the rack.
- Cabling the storage subsystem (see [section "SAS Connection" on page 32](#)).
- Setting the desired system parameters.
- Connecting the storage subsystem to the mains voltage (see [section "Power Supply Connection" on page 34](#)).
- Switching ON the storage subsystem (see [section "Switching the Storage Subsystem ON/OFF" on page 20](#)).

3.2. Unpacking the Storage Subsystem



CAUTION!

Please note the safety instructions in [chapter "Important Notes" on page 9](#).

Enlist the help of others to carry the storage subsystem.

You should retain the original packing of the storage subsystem for possible further transport.

- Unpack all parts.
- Check the contents of the package for visible transport damage.
- Check whether the delivery matches the information given on the delivery note.
- Check whether the first page of the guarantee booklet has been completed in full.

If you find transport damage or inconsistencies between the contents of the package and the delivery note, inform your supplier immediately!

3.3. Installing the Storage Subsystem in the Rack



CAUTION!

- Please observe the safety precautions and references to mounting into the rack in [chapter "Important Notes" on page 9](#).
- At least two people are needed to position the server in the rack.
- For safety reasons, no more than one unit may be withdrawn from the rack at any one time during installation and maintenance work. There is a danger that the rack will tilt forward.
- Ensure that the anti-tilt bracket is correctly mounted when you set up the rack.

3.3.1. Requirements of the Rack

To accommodate the ventilation concept and ensure proper ventilation of the components in the rack, any unused areas must be closed using dummy covers.

Power is supplied via the socket strips available in the rack.

3.3.2. Rack mounting

i The descriptions and figures in this section refer to the current support system. For other support systems you will find the appropriate description in the packaging of the rack mounting kit.

For installation in the Rack, the rack mounting kit delivered with the subsystem is used.

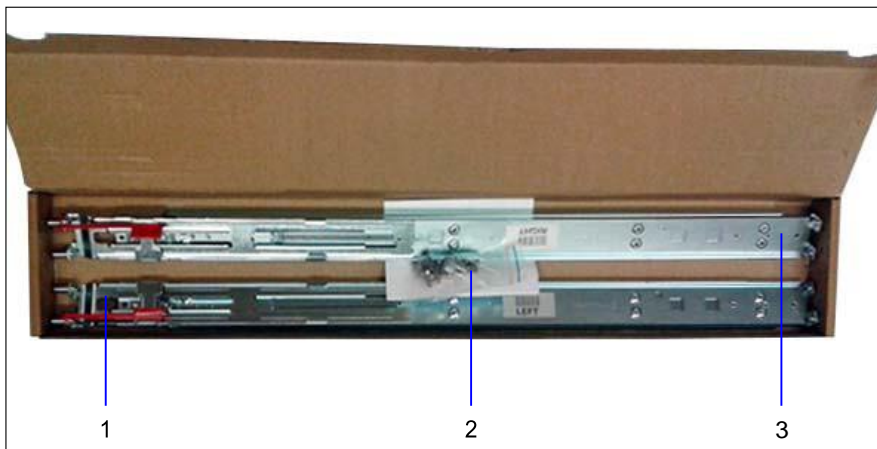

Figure 2: Rack mounting kit

1	Left sliding rail (rear end)
2	Screws, cage nuts and mounting instruction
3	Right sliding rail (front end)

Mounting positions

The following picture shows the mounting positions, screws and cage nuts of two subsystems one upon the other in a Rack.

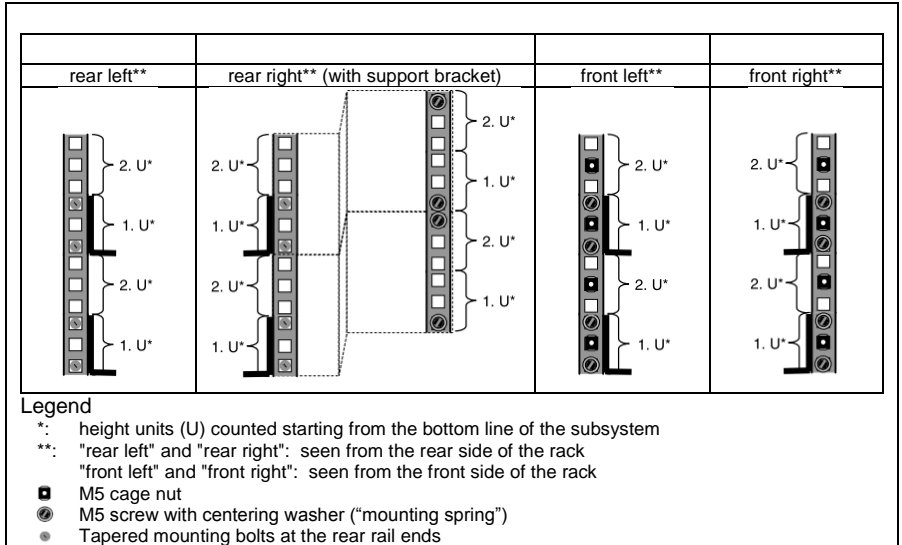

Figure 3: Mounting positions

For mounting the left sliding rail the support bracket must first be mounted on the rear left support upright. The bracket must be mounted level with the lower edge of the device.



Figure 4: Installing the support bracket

- Insert the sliding rails in the rack. Compress the sliding rail to its length.

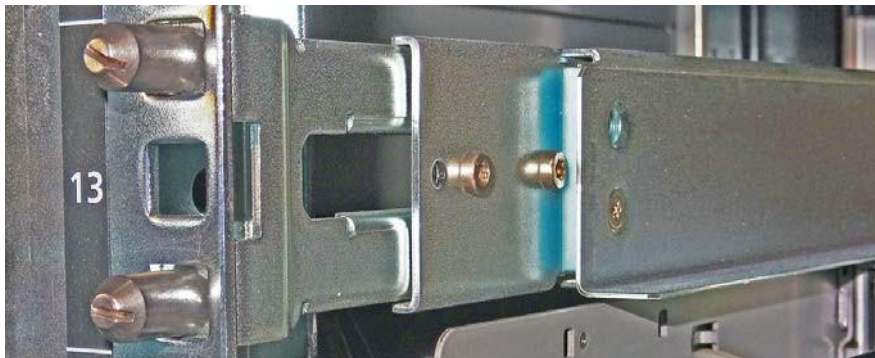

Figure 5: Right side sliding rail (rear side of the rack, tapered mounting bolts at height unit 13)

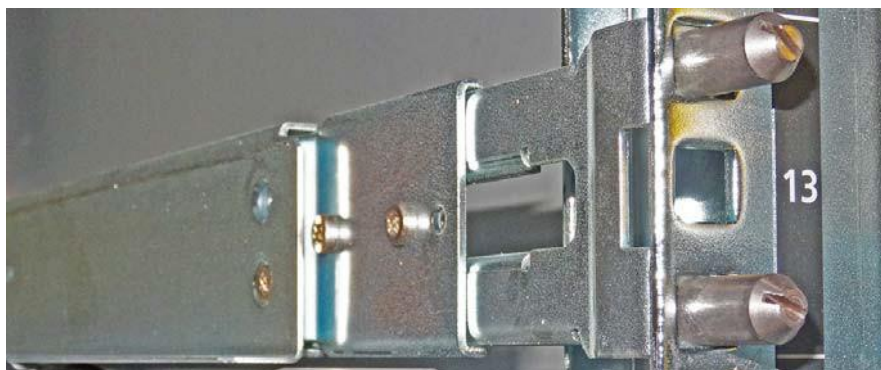

Figure 6: Left side sliding rail (rear side of the rack, tapered mounting bolts at height unit 13)

- On the front of the rack, place the screws in the appropriate holes of the support upright and screw the sliding rails tight at the 19" profiles on the front.

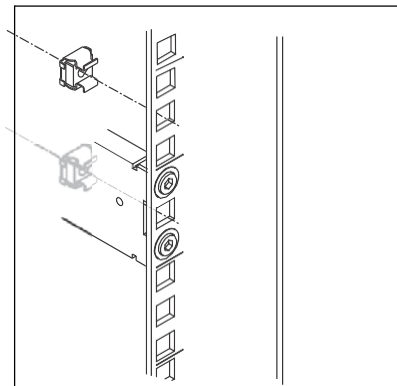

Figure 7: Position of the cage nuts (front side of the rack, left support upright as example)

- Place the cage nuts for fastening the subsystem in the appropriate holes of the front support uprights.
- Put the subsystem on the support angles of the sliding rails and push the subsystem into the rack as far as it will go.

The following steps can be performed by a single person:



Figure 8: Fastening the Storage Subsystem

- Secure the subsystem within the rack using the two screws on each side.

3.4. Switching the Storage Subsystem ON/OFF

The Storage Subsystem have power switches. Automatic power on via SAS Link can only be used if the PSU power switches are set to *ON*.

4. Operating and Indicator Elements

This section describes the position and meaning of the operating and indicator elements on the Storage Subsystem.

4.1. Front Side

An operation panel is installed in the front of the Storage Subsystem.

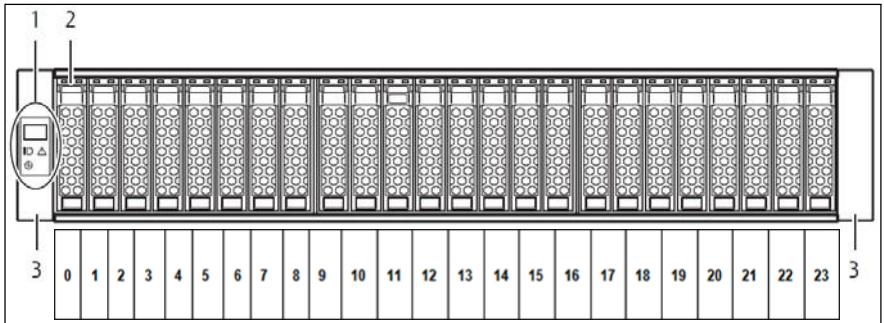

Figure 9: Front of the Storage Subsystem (disk slot numbering below)

1. Operation panel
2. 2.5" disk drive
3. Flange covers

4.1.1. Operation Panel

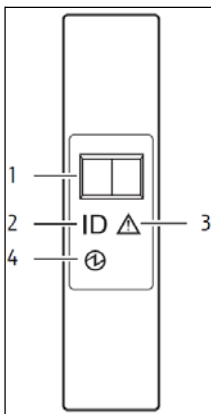





Figure 10: Operation panel

1. ID number
The number identifies the drive enclosure.
2. Identify LED
3. Fault LED
4. Power LED

LED	LED Status	Meaning
Identify	 (blinks blue)	Specifies the installation location of the storage subsystem.
Fault	 (amber)	The drive enclosure is in error status.
Power	 (green)	DC power is supplied to the drive enclosure.

4.1.2. Disk LEDs

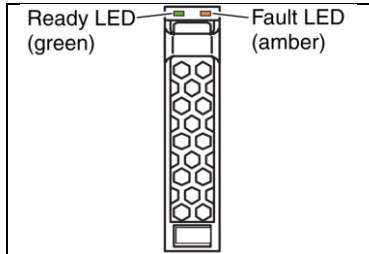





Figure 11: Disk LEDs

LED	LED Status	Meaning
Ready	 (green)	The disk drive is in normal status.
	 (blinks green)	
Fault	 (amber)	The disk drive is in error status.
	 (blinks amber)	Identifies the location of the drive.

4.2 Rear Side

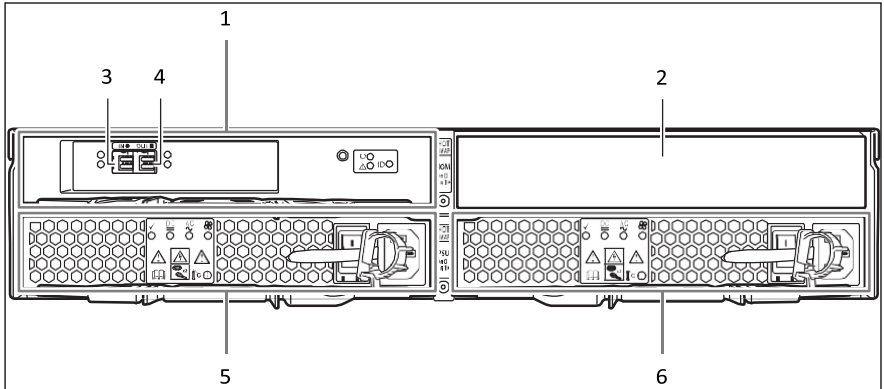

Figure 12: Rear side of the Storage Subsystem

1. I/O module (IOM#0)
2. Cover
3. Mini SAS HD IN Port
4. Mini SAS HD OUT Port
5. Power supply unit (PSU#0)
6. Power supply unit (PSU#1)

4.1.3. I/O Module

The I/O module is a component that controls how the controller and the drives interact.

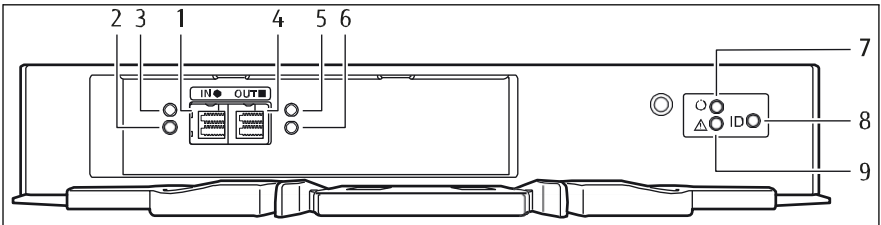









Figure 13: I/O module of the Storage Subsystem

1. SAS IN port
2. SAS IN fault LED
3. SAS IN link LED
4. SAS OUT port
5. SAS OUT link LED
6. SAS OUT fault LED
7. Ready LED
8. Identify LED
9. Fault LED

LED	LED Status	Meaning
SAS IN link	 (green)	The link between the SAS IN port and the source port has been established.
SAS IN fault	 (amber)	not applicable
SAS OUT link	 (green)	The link between the SAS OUT port and the destination port has been established.
SAS OUT fault	 (amber)	The link between the SAS OUT port and the destination port is in error status.

LED	LED Status	Meaning
Ready	 (green)	The I/O module is in normal status.
Identify	 (blinks blue)	Identifies the installation location of the I/O module.
Fault	 (amber)	The I/O module is in error status.

4.1.4. Power Supply Unit (PSU)

The power supply unit transforms input AC power from a power socket to DC power and supplies power to each component.

Each power supply unit contains fans.

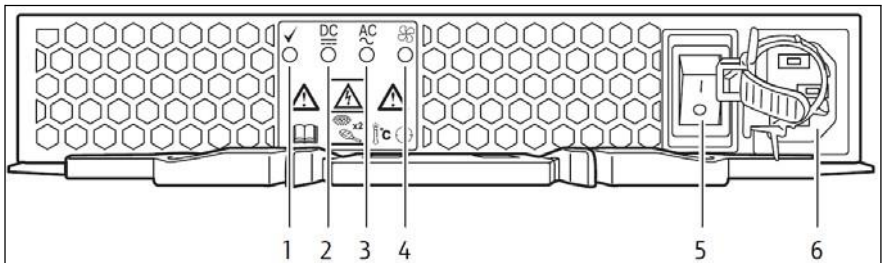





Figure 14: Power supply unit (PSU) of the Storage Subsystem

1. Power LED
2. Fault LED
3. AC missing LED
4. Fan fail LED
5. Power switch to power on and off the AC power supply.
6. Inlet for connecting an AC power cord.

LED	LED Status	Meaning
Power	 (green)	AC power is supplied to the power supply unit.
Fault	 (amber)	The power supply is in error status.
AC missing	 (amber)	AC power is not supplied to this power supply unit, but AC power is supplied to the other power supply unit.
Fan fail	 (amber)	The fan in the power supply unit is in error status.

5. Hard Disk Drives

The Storage Subsystem can accommodate up to 24 2.5" hard disk drives.

5.1. Handling Hard Disk Drives

Hard disk drives are highly sensitive electromagnetic devices and must be handled with great care. It is extremely likely that an incorrect handling will lead to a partially and/or total failure of the hard disk drives.

These failures will result in data errors and to loss of data or to total destruction of the hard disk drive.

Please observe following rules, which will help to avoid the occurrence of this type of problems:

- Store and transport hard disk drives only within the limits stipulated in the specification.
- When transporting hard disk drives (even over short distances), always use the original packaging (ESD labeling).
- Never expose a hard disk drive to a temperature shock. Avoid the formation of condensation inside and on the outside of the hard disk drives. The hard disk drives may be exposed only to defined temperature and climatic conditions.
- Hard disks must be put on antistatic mats with cushion. Never put an HDD on another hard disk or directly on metallic desks. Keep enough distance between hard disks to prevent the contact of two disks at handling.
- Always put the hard disk drive down carefully, with its largest surface facing downwards, to avoid the danger of tipping over.

5.2. Removing/Installing Hard Disk Drive/Drive Dummy

The hard disk drives which can be ordered for the Storage Subsystem are delivered pre-installed in frames. Removing a hard disk drive from the frame may only be done in authorized repair centers.



Figure 15: 2.5" hard disk drive in frame



Figure 16: 2.5" drive dummy

Free bays are provided with a drive dummy which must be removed before fitting another hard disk drive.



Keep a drive dummy for future use. If you remove the hard disk drive again and do not fit a replacement, you must put back the dummy drive because of cooling.



Figure 17: Removing/installing a 2.5" hard disk drive

Removing a hard disk drive

- Press the green push button of the disk drive and open the lock lever.
- Hold the lock lever and pull the disk drive.

Installing a hard disk drive



CAUTION!

The hard disk drive must be acclimatized in its operating environment for an acclimatization time.

Temperature difference (°C) (operating environment/outside)	Minimum acclimatization time (hours)
5	3
10	5
15	7
20	8
25	9
30	10

Attach hard disk drives to the drive bays in the ascending order, starting with bay no. 0. For disk slot numbering, see also [section "Front Side" on page 21](#).

- Press the green push button of the disk drive and open the lock lever.
(seealso [Figure 17](#)).

- During insertion of the disk drive, hold it firmly with both hands in order not to cause any vibration or shock.
- Push the disk drive with the lever opened into the empty bay until it stops.
- Return the lock lever. A clicking sound from it indicates that it is locked.

6. Connections

If you would like to put the Storage Subsystem into operation, the SAS and the power supply connections must be inserted.

6.1. SAS Connection

The required connections are on the rear panel of the storage subsystem.

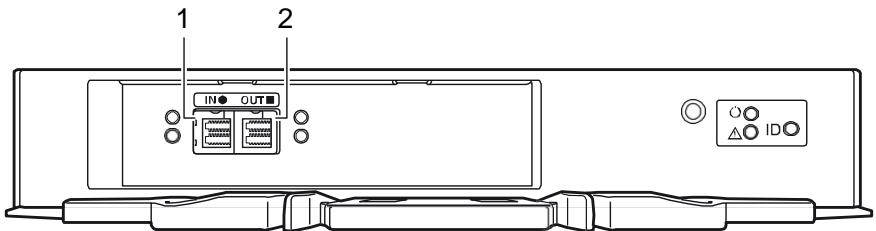

Figure 18: SAS connections of the Storage Subsystem I/O module (Mini SAS HD ports)

1. SAS IN port
 2. SAS OUT port
- Set up the data connection between the server and the Storage Subsystem by inserting the Mini SAS HD plug of the SAS cable coming from the server into the SAS IN port connector of the Storage Subsystem.



The cable tab must always be located at the lower side of the plug.



Figure 19: Orientation of the Mini SAS HD plugs

Ensure that the plug engages securely to the SAS connector. Only in this way can the flow of data between the server and the storage subsystem be guaranteed.

For removing the SAS cable, the blue tab needs to be pulled out.

6.2. Power Supply Connection

The storage subsystem is supplied with the power supply voltage via the four delivered power cables.

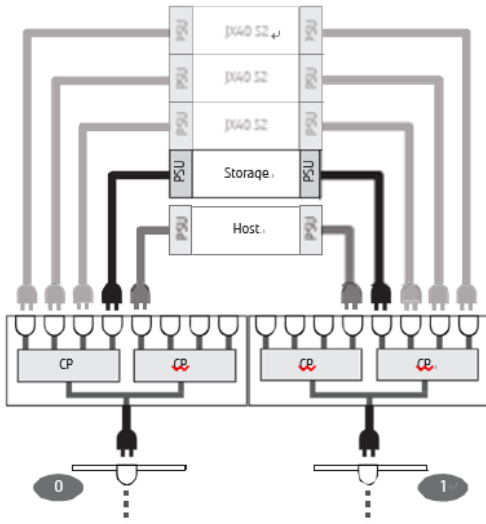

Figure 20: Connecting the four power cables to two power supply lines

- Plug one end of the power cables into the port of the power supply unit on the rear panel of the storage subsystem.
- Plug the other end of the power cables into a safety socket on the rack power supply socket strip.

i

Ensure that at least one power supply unit of the Storage Subsystem and one power supply unit of the server attached to the subsystem are connected with the same phase.

In order to set up the power supply connection of the storage subsystem with phase redundancy, the two power supply units must be connected to two different phases or to two different circuits of the rack installation.

Ensure that the safety sockets used to connect the storage subsystem are protected sufficiently by a 16 A or 15 A (USA) automatic cutout.

7. Configurations



Guideline

The Storage Subsystem are mixable up to 4 shelves per chain. The following configuration drawings are valid for both or mixed subsystems.

7.1 Basic RAID controller / HBA configuration

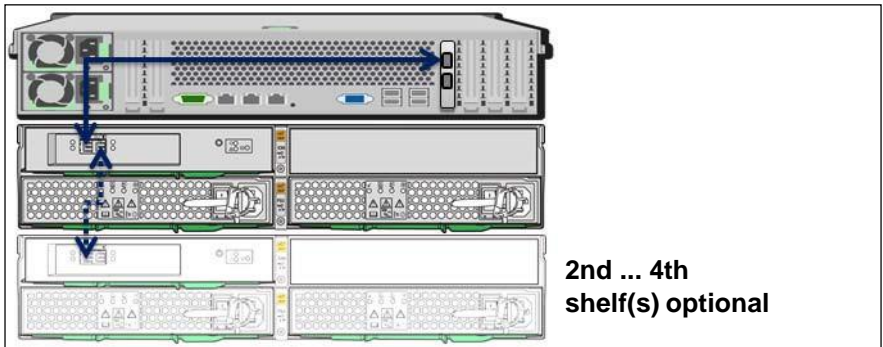

Figure 21: Basic RAID controller / HBA configuration

- Server with RAID controller or host bus adapter.
- Storage Subsystem(s) with one I/O module are mixable up to 4 shelves.

7.1. RAID controller / HBA configuration and maximal storage configuration

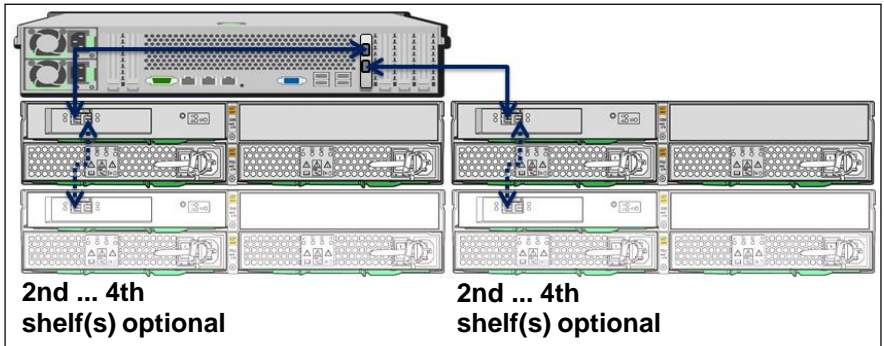

Figure 22: RAID controller / HBA configuration and up to 8 / 4 enclosures

- Server with Dual-Port RAID controller or host bus adapter.
- Storage Subsystem(s) with one I/O module.

7.2. RAID controller / HBA configuration with two way storage

7.2.1. Host Bus Adapter

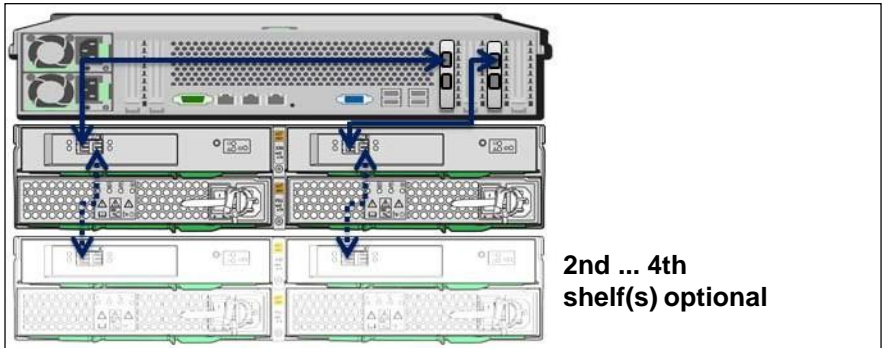

Figure 23: Redundant host bus adapter and redundant I/O module with two way storage configuration

- Server with two host bus adaptors
- Storage Subsystem(s) with two I/O modules.

7.3. Redundant controller and storage two way configuration

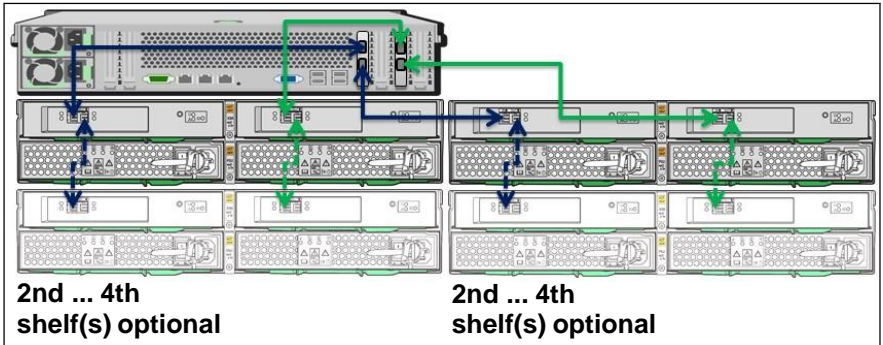

Figure 24: Redundant HBA and redundant storage two way configuration

- Server with two dual-port host bus adapters.
- Storage Subsystem(s) with two I/O modules.

7.4. Redundant controller and storage with file sharing

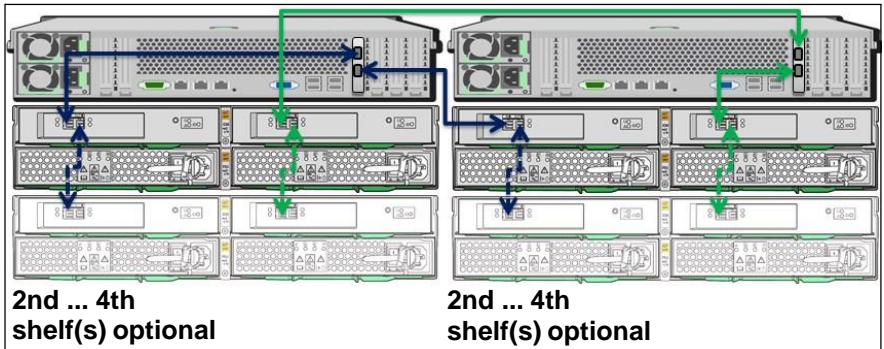

Figure 25: Redundant HBA and redundant storage file sharing configuration

- Servers with two Dual-Port host bus adapters.
- Storage Subsystems with two I/O modules.

8. Fault Clearing



CAUTION!

Please note the safety instructions in [chapter "Important Notes" on page 9](#).

If a fault occurs, attempt to rectify it in accordance with the measures set out below:

- Which are described in this chapter,
- Which are described in the documentation for the connected server and the RAID controller or HBA used.

If you cannot rectify the fault, proceed as follows:

- Note the steps that you have performed and the state which was active when the error occurred. Note also any error message which may have been displayed.
- Contact our service organization.

8.1. Problem Solutions and Tips

The following sections describe irregularities which can be observed on the storage subsystem in case of faults. Their possible causes are named and there are instructions for fault clearing.

8.1.1. Identification LED (Front)

8.1.1.1 Identification status LED is on

ServerView switched on this LED for identification. No error.

8.1.2. Fault LED (Front)

8.1.1.2 Fault LED is on during operation

- Hardware error detected (on); ServerView detected a fault (blinking or on), check ServerView for service action.
- Check the Error LEDs of the build in components: power supply units, fan expander module(s), I/O module(s), hard disk drives.

8.1.3. Power LED (Front)

If the power LED is green the device is switched on and the power supply and at least one power supply unit are OK.

8.1.1.3 Power LED remains dark Power cable not connected correctly

- Ensure that the power cable on the storage subsystem and the safety socket are connected correctly.

4

Power supply unit defective

- Check the LEDs of the power supply units. If the fault LED (amber LED) on a power supply unit is on, the power supply unit is defective.
- Before you replace the defective power supply unit, please contact the Our Service Desk first.

For more information refer to [section "Power Supply Unit \(PSU\)" on page 27](#).

8.1.4. I/O Module (IOM)

- Check the IOM LEDs.
- Check the SAS IN port and SAS OUT port LEDs (amber LEDs). If they are on, try to solve the SAS connection problems indicated by them. If the fault LED (amber LED) on a IOM is on, the IOM is defective.
- Before you replace the defective IOM, please contact our Service Desk first.

For more information refer to [section "I/O Module" on page 25](#).

8.1.5. Temperature Sensor Error Message

Temperature too high

The temperature sensors have measured an extreme temperature (tolerable temperature for operation see [section "Technical Data" on page 7](#)).

- Check ServerView for service action.

8.1.6. Error LED of the Hard Disk Drive Indicates Disk Failure

- Check whether the hard disk drive has been correctly installed and locked (see [section "Removing/Installing Hard Disk Drive/Drive Dummy" on page 29](#)).
- Replace the hard disk drive. If the error LED is still on, contact the service organization.

8.1.7. The Storage Subsystem does not Power on with the Attached Server

- The PSU power switches must be set to *ON*.

Incorrect cabling

- Ensure that the SAS cabling is correct (SAS IN port); the Storage Subsystem is powered on by SAS link from the Server.

9. Replacing Components



CAUTION!

It is imperative that you read the chapter [chapter "Important Notes" on page 9](#) in this manual **before** you carry out work on your storage subsystem.

Information about relevant error messages concerning the components to be replaced can be found here:

- section "Operation Panel" on page 22
- section "Power Supply Unit (PSU)" on page 27
- section "I/O Module" on page 25
- chapter "Fault Clearing" on page 40



See "Hard Disk Drives" on page 28 for replacing hard disk drives.

9.1. Power Supply Unit

The power supply units are supplied with mains voltage via the supplied connecting leads.

The power supply units can be connected to two different phases of the in-house circuit in order to achieve phase redundancy (see [section "Power Supply Connection" on page 34](#)).

The Storage Subsystem has two power supply units, which makes it possible for a failed unit to be replaced while the system is running. Each power supply unit contains fans.



CAUTION!

When replacing a power supply unit, do not leave it removed for longer than 5 minutes to prevent temperature rise.

- At the rear of the storage subsystem, switch off the defective power supply unit using its power switch.
- Remove the AC cord clamp and remove the lead.

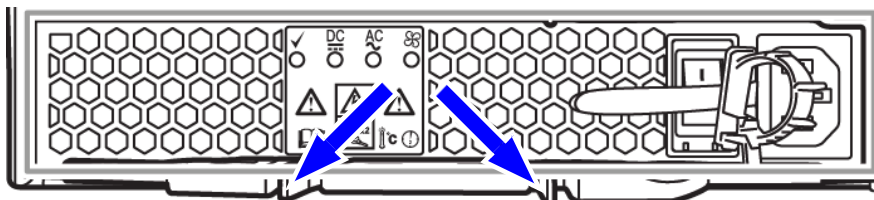

Figure 26: Ejector levers of a power supply unit

- Release the latch of the ejector lever on both sides using both hands, and pull the unit out halfway.
- Take the power supply unit out of the bay while supporting its bottom. To install the power supply unit follow the above steps in reverse.
- Push the new power supply unit into the empty bay halfway while supporting its bottom.
- Open the ejector levers and insert the power supply unit. Then press the levers fully inward and confirm that the latches are fastened.
- Connect the lead to the power supply unit and set the AC cord clamp.
- Connect the power cable to the mains.
- Verify that the Power LED of the unit shows green light.

9.2. I/O Module



This component is **not** hot replaceable. If the defective I/O module has not failed completely, the user must make sure that the traffic on the affected SAS connections is stopped and no data loss occurs.



CAUTION!

Use a wrist strap during maintenance because the unit may possibly be damaged additionally by static electricity of the human body.

- Remove the SAS cables (after keeping a record for correct reconnecting).

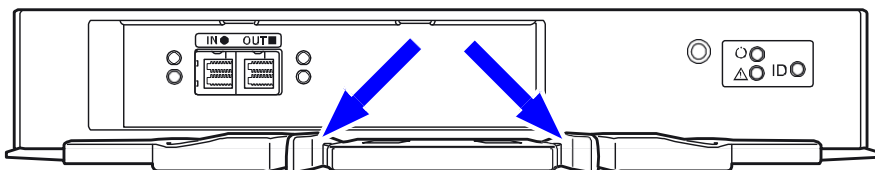

Figure 27: Removing the I/O module

- Release the latch of ejector lever on both sides with fingers of both hands, and pull the I/O module out halfway.
- Take the I/O module out of the bay while supporting its bottom. To install the I/O module follow the above steps in reverse.
- If the IN link LED for the replaced I/O module remains off, go to the OUT port from which the affected SAS cable comes and disconnect and connect the cable plug at this OUT port.
- Verify that the status LED of the I/O module shows a normal status after not exceeding 10 minutes.

9.3. Operation Panel

i This component is **not** hot replaceable.

- At the rear of the storage subsystem, switch off the power supply units using their power switches.
- Remove the AC cord clamps and remove the leads.
- Remove the flange cover capping the operation panel.

i Record the slot positions of the disks to be removed in the next step.

- Remove some disks nearest to the operation panel in order to have free mounting place for unscrewing the operation panel.

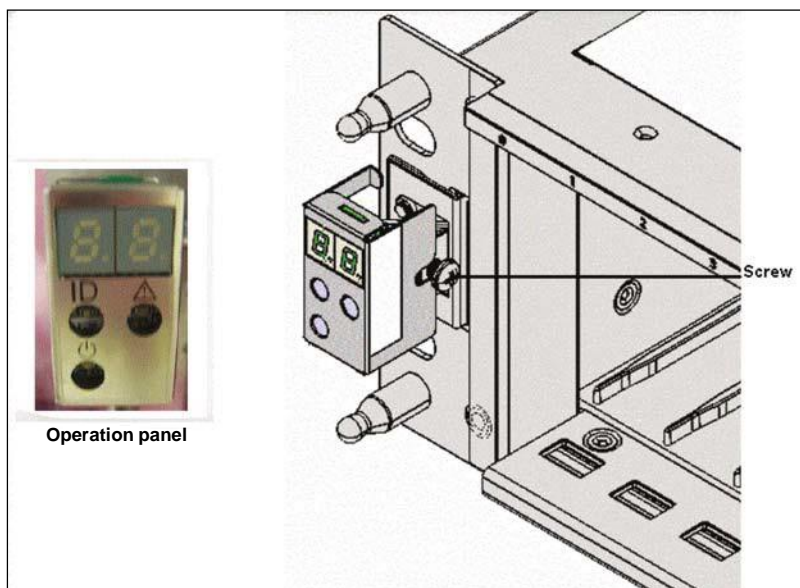

Figure 28: Screw to be loosened for removing the 2.5" operation panel

- Loosen the screw holding the operation panel.
- Carefully take off the operation panel for some millimeters.

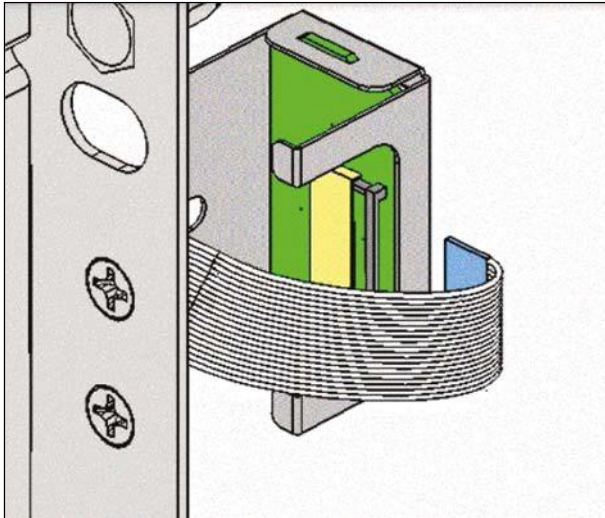

Figure 29: Ribbon cable connecting the operation panel

- Remove the ribbon cable connecting the operation panel.
- Mont the new operation panel in reverse order.



Install the disks as recorded when you removed them.

Abbreviations

The technical terms and abbreviations given below represent only a selection of the full list of common technical terms and abbreviations.

Not all technical terms and abbreviations listed here are valid for the described device.

AC

Alternating Current

ACPI

Advanced Configuration and Power management Interface

ANSI

American National Standard Institute

ASR&R

Automatic Server Reconfiguration and Restart

ATA

Advanced Technology Attachment

BBU

Battery Backup Unit

BIOS

Basic Input-Output System

BMC

Baseboard Management Controller

CC

Cache Coherency

CHS

Cylinder Head Sector

CMOS

Complementary Metal Oxide Semiconductor

COM

Communication

Abbreviations

CPU

Central Processing Unit

DC

Direct Current

DIMM

Dual Inline Memory Module

DIP

Dual Inline Package

DMA

Direct Memory Access

DMI

Desktop Management Interface

DRAM

Dynamic Random Access Memory

ECC

Error Checking and Correcting

EFI

Extensible Firmware Interface

EMC

Electromagnetic Compatibility

EMI

Electromagnetic interference

EMP

Emergency Management Port

EMRL

Embedded RAID Logic

ESD

Electrostatic Sensitive Devices, ElectroStatic Discharge

EVRD

Enterprise VRD

FPC	Front Panel Controller
FRU	Field Replaceable Unit
FSB	Front Side Bus
GUI	Graphical User Interface
HBA	Host Bus Adapter
HDD	Hard Disk Drive
HPC	Hot-plug Controller
HSC	Hot-swap Controller
I²C	Inter-Integrated Circuit
I/O	Input/Output
ICM	Intelligent Chassis Management
ID	Identification
IDE	Integrated Drive Electronics
IEC	International Electrotechnical Commission
IME	Integrated Mirroring Enhanced

Abbreviations

IPMB

Intelligent Platform Management Bus

IPMI

Intelligent Platform Management Interface

iRMC

integrated Remote Management Controller

IRQ

Interrupt Request Line

LAN

Local Area Network

LBA

Logical Block Address

LCD

Liquid Crystal Display

LUN

Logical Unit Number

LVD

Low-Voltage Differential SAS

MMF

Multi-Mode Fiber

MRL

Manual-Retention Latch

NMI

Non-Maskable Interrupt

NVRAM

Non-Volatile Random Access Memory

OEM

Original Equipment Manufacturer

OHCI

Open Host Controller Interface

OS	Operating System
PCI	Peripheral Component Interconnect
PDA	Prefailure Detection and Analyzing
PDB	Power Distribution Board
PIO	Programmed Input Output
PLD	Programmable Logic Device
POST	Power-On Self Test
PS(U)	Power Supply (Unit)
RAID	Redundant Arrays of Independent Disks
RoHS	Restriction of the Use of Certain Hazardous Substances (Waste from Electric and Electronic Equipment, EU guideline)
RoMB	RAID on Motherboard
RSB	RemoteView Service Board
RST	ReSeT
RTC	Real Time Clock
RTDS	Remote Test and Diagnostics System

SAF-TE

SCSI-Accessed Fault-Tolerance Enclosures

SAS

Serial Attached SCSI

SATA

Serial ATA

SBE

Single-Bit Error

SCA

Single Connector Attachment

SCSI

Small Computer System Interface

SDR

Sensor Data Record

SDRAM

Synchronous Dynamic Random Access Memory

SEL

System Event Log

SHDG

Server Hardware Design Guide

SMI

System Management Interrupt

SMM

Server Management Mode

SMP

Symmetrical Multi-Processing

SSD

Solid State Disk

SSU

System Setup Utility

SVGA

Super Video Graphics Adapter

UHCI

Unified Host Controller Interface

USB

Universal Serial Bus

WEEE

Waste from Electric and Electronic Equipment (EU directive)

WfM

Wired for Management

WOL

Wake up On LAN

Figures

Figure 1: Electrostatic-sensitive component sticker 11

Figure 2: Rack mounting kit 16

Figure 3: Mounting positions 17

Figure 4: Installing the support bracket..... 17

Figure 5: Right side sliding rail (rear side of the rack, tapered mounting bolts at height unit 13)..... 18

Figure 6: Left side sliding rail (rear side of the rack, tapered mounting bolts at height unit 13)..... 18

Figure 7: Position of the cage nuts (front side of the rack, left support upright as example) 19

Figure 8: Fastening the Storage Subsystem 19

Figure 9: Front of the Storage Subsystem (disk slot numbering below)..... 21

Figure 10: Operation panel 22

Figure 11: Disk LEDs 23

Figure 12: Rear side of the Storage Subsystem 24

Figure 13: I/O module of the Storage Subsystem..... 25

Figure 14: Power supply unit (PSU) of the Storage Subsystem 27

Figure 15: 2.5" hard disk drive in frame..... 29

Figure 16: 2.5" drive dummy..... 29

Figure 17: Removing/installing a 2.5" hard disk drive 30

Figure 18: SAS connections of the Storage Subsystem I/O module (Mini SAS HD ports) 32

Figure 19: Orientation of the Mini SAS HD plugs..... 32

Figure 20: Connecting the four power cables to two power supply lines.. 34

Figure 21: Basic RAID controller / HBA configuration.....	35
Figure 22: RAID controller / HBA configuration and up to 8 / 4 enclosures	36
Figure 23: Redundant host bus adapter and redundant I/O module with two way storage configuration	37
Figure 24: Redundant HBA and redundant storage two way configuration	38
Figure 25: Redundant HBA and redundant storage file sharing configuration.....	39
Figure 26: Ejector levers of a power supply unit	45
Figure 27: Removing the I/O module.....	46
Figure 28: Screw to be loosened for removing the 2.5" operation panel ..	47
Figure 29: Ribbon cable connecting the operation panel.....	48