



StadiumVision



Cisco StadiumVision Video Endpoint (DMP) Design and Implementation Guide

Release 2.4

November 2011

Corporate Headquarters
Cisco Systems, Inc.
170 West Tasman Drive
San Jose, CA 95134-1706
USA
<http://www.cisco.com>
Tel: 408 526-4000
800 553-NETS (6387)
Fax: 408 526-4100

THE SPECIFICATIONS AND INFORMATION REGARDING THE PRODUCTS IN THIS MANUAL ARE SUBJECT TO CHANGE WITHOUT NOTICE. ALL STATEMENTS, INFORMATION, AND RECOMMENDATIONS IN THIS MANUAL ARE BELIEVED TO BE ACCURATE BUT ARE PRESENTED WITHOUT WARRANTY OF ANY KIND, EXPRESS OR IMPLIED. USERS MUST TAKE FULL RESPONSIBILITY FOR THEIR APPLICATION OF ANY PRODUCTS.

THE SOFTWARE LICENSE AND LIMITED WARRANTY FOR THE ACCOMPANYING PRODUCT ARE SET FORTH IN THE INFORMATION PACKET THAT SHIPPED WITH THE PRODUCT AND ARE INCORPORATED HEREIN BY THIS REFERENCE. IF YOU ARE UNABLE TO LOCATE THE SOFTWARE LICENSE OR LIMITED WARRANTY, CONTACT YOUR CISCO REPRESENTATIVE FOR A COPY.

The Cisco implementation of TCP header compression is an adaptation of a program developed by the University of California, Berkeley (UCB) as part of UCB's public domain version of the UNIX operating system. All rights reserved. Copyright © 1981, Regents of the University of California.

NOTWITHSTANDING ANY OTHER WARRANTY HEREIN, ALL DOCUMENT FILES AND SOFTWARE OF THESE SUPPLIERS ARE PROVIDED "AS IS" WITH ALL FAULTS. CISCO AND THE ABOVE-NAMED SUPPLIERS DISCLAIM ALL WARRANTIES, EXPRESSED OR IMPLIED, INCLUDING, WITHOUT LIMITATION, THOSE OF MERCHANTABILITY, FITNESS FOR A PARTICULAR PURPOSE AND NONINFRINGEMENT OR ARISING FROM A COURSE OF DEALING, USAGE, OR TRADE PRACTICE.

IN NO EVENT SHALL CISCO OR ITS SUPPLIERS BE LIABLE FOR ANY INDIRECT, SPECIAL, CONSEQUENTIAL, OR INCIDENTAL DAMAGES, INCLUDING, WITHOUT LIMITATION, LOST PROFITS OR LOSS OR DAMAGE TO DATA ARISING OUT OF THE USE OR INABILITY TO USE THIS MANUAL, EVEN IF CISCO OR ITS SUPPLIERS HAVE BEEN ADVISED OF THE POSSIBILITY OF SUCH DAMAGES.

Cisco and the Cisco Logo are trademarks of Cisco Systems, Inc. and/or its affiliates in the U.S. and other countries. A listing of Cisco's trademarks can be found at

www.cisco.com/go/trademarks. Third party trademarks mentioned are the property of their respective owners. The use of the word partner does not imply a partnership relationship between Cisco and any other company. (1005R)

Any Internet Protocol (IP) addresses and phone numbers used in this document are not intended to be actual addresses and phone numbers. Any examples, command display output, network topology diagrams, and other figures included in the document are shown for illustrative purposes only. Any use of actual IP addresses or phone numbers in illustrative content is unintentional and coincidental.

Copyright © 2011 Cisco Systems, Inc. All rights reserved.

Table of Contents

| | |
|--|-----------|
| About this Guide | 7 |
| Audience | 7 |
| Related Documentation | 7 |
| Document History | 7 |
| What's New in Release 2.4? | 8 |
| Supported Software and Caveats | 8 |
| Chapter 1 Overview | 9 |
| Cisco StadiumVision Components | 9 |
| Video Delivery Overview | 10 |
| DMP 4310G Hardware | 11 |
| What Comes in the Box? | 12 |
| DMP 4310G Rear Panel | 13 |
| DMP 4310G IR Remote | 13 |
| DMP 4310G Software Architecture | 14 |
| Content Delivery | 15 |
| Chapter 2 Planning | 17 |
| TV Recommendations | 17 |
| Considerations When Planning TV Purchases..... | 18 |
| Outdoor TV Options | 18 |
| DMP and TV Mounting Options | 19 |
| Cisco Träger Mounting Bracket (custom) | 20 |
| Chief FCA100 DMP Mounting Brackets | 21 |
| Cisco DMP Mounting Kits | 21 |
| TV Mount Kits | 23 |
| DMP Power Options | 23 |
| UTP Cable Runs | 23 |
| DMP to TV Connections | 24 |
| HDMI to HDMI Connection | 24 |
| HDMI to DVI Connection..... | 25 |
| DMP to TV Component Connection | 25 |

| | |
|--|-----------|
| DMP to TV Composite Connections | 26 |
| DMP TV Control Connections..... | 27 |
| Using a Direct RS-232 Connection..... | 28 |
| Guidelines for RS-232 Cables | 28 |
| Using an RS-232-to-IR Adapter Connection..... | 29 |
| IR Remote Sensor and IR Extender | 30 |
| DMP and TV Location..... | 30 |
| Introducing Locations..... | 30 |
| Location Naming Convention..... | 31 |
| Closed Captioning..... | 32 |
| Video Wall Design | 33 |
| TV-Based Tile Matrix Video Wall | 34 |
| DMP-Based Tile Matrix Video Wall..... | 35 |
| TV Qualification | 37 |
| Test Bed Topology..... | 38 |
| Bill of Materials for Test Bed..... | 39 |
| Firmware Versions | 39 |
| Video and Audio..... | 40 |
| RS-232..... | 41 |
| Network Readiness | 42 |
| Chapter 3 DMP Deployment..... | 44 |
| Installation Prerequisite Steps | 44 |
| Installation Steps and Flow | 44 |
| DMP Auto Registration and Provisioning..... | 45 |
| Understanding DMP Auto-Registration | 45 |
| Auto Registration Workflow | 46 |
| Understanding DMP Provisioning..... | 46 |
| Provisioning Workflow..... | 47 |
| Provisioning Functional Description..... | 47 |
| Preparing CISCO STADIUMVISION DIRECTOR, DHCP Server & DMP for Auto Registration | 52 |
| Enabling Auto Registration and Auto-Provisioning..... | 53 |
| Configuring the DMP Firmware Version | 53 |
| Configuring the Default Video Channel | 54 |
| Configuring DHCP Options | 54 |

| | |
|--|------------|
| Configuring Display Specifications for TVs..... | 58 |
| Defining External Volume Commands..... | 62 |
| TV Status | 68 |
| Viewing the Workflow Status..... | 70 |
| Viewing the Workflow Status in the Dashboard..... | 70 |
| Viewing Detailed HDMI Detection Status | 74 |
| Querying the Auto-Provisioning Status..... | 74 |
| Viewing Auto-Provisioning Status on the TV | 76 |
| Viewing the DMP Readiness State in the Control Panel | 76 |
| DMPs and Locations | 77 |
| Managing DMP and Location Objects | 77 |
| Manual Administration | 77 |
| Bulk Administration | 78 |
| Mapping a DMP to a Location..... | 81 |
| Manual Mapping | 82 |
| Bulk Mapping | 82 |
| Chapter 4 Tips and Best Practices..... | 85 |
| Verifying the DMP Display Attributes | 85 |
| Domain Name Service..... | 86 |
| Replacing a failed DMP | 86 |
| Configuring CDP in the DMP | 87 |
| Configuring Civic Location in the Switch..... | 88 |
| Chapter 5 Troubleshooting..... | 90 |
| Auto-Registration Issues | 90 |
| DMP POE Issue..... | 92 |
| DMP HDMI Issue | 94 |
| DMP Reboot Behaviour..... | 94 |
| DMP Recovery Behavior | 94 |
| Common Problems and Resolutions..... | 95 |
| Appendix A: DMP Connector Pin outs and Cable Schematic..... | 100 |
| DMP 4305 RS-232 pin outs..... | 100 |
| DMP 4310 RS-232 pin outs..... | 100 |
| DMP 4310 S-Video DIN to Component pin outs | 101 |

Appendix B: Determining the RS-232 Command Strings103

About this Guide

This document provides guidelines and techniques for designing, planning, implementing, and operating the video delivery component of Cisco StadiumVision. It includes information on how to deploy Digital Media Players (DMP) in a Cisco StadiumVision venue, best practices for enabling the cable connections that control TVs, and how to configure DMP settings for optimal display.

Audience

This document is intended for Cisco StadiumVision technical engineers and product managers. Additionally, technical sales and marketing people can use this document as a master reference guide when helping customers understand and order the components they need to enable video delivery for their Cisco StadiumVision solution.

Related Documentation

For additional solutions deployment documentation, please refer to the documents below, which are posted at:

http://www.cisco.com/en/US/products/ps11274/tsd_products_support_series_home.html

Getting Started with the Management Dashboard

Management Dashboard Device Configuration Commands

Management Dashboard Device Details Status Guide

Cisco StadiumVision Director Bulk Administration Tool, Release 2.4

Document History

Table 1. Revision History

| Date | Release | Description |
|------------------|-------------------|--------------------|
| November 4, 2011 | Release 2.4.0-147 | First publication. |

What's New in Release 2.4?

Release 2.4 includes enhanced video delivery services and functionality. Refer to the [Cisco StadiumVision Release Notes for Release 2.4](#) for a description of additional features available in Release 2.4.

Supported Software and Caveats

Refer to the [Cisco StadiumVision Release Notes for Release 2.4](#) for information about the supported DMP software and firmware as well a list of caveats.

Chapter 1 Overview

StadiumVision is a proven, end-to-end, high-definition IPTV solution that is implemented on top of a Cisco Connected Stadium network and provides advanced video content management and delivery. It is a centrally managed, video processing and distribution solution that enables the integration and automated delivery of customized and dynamic content from multiple sources to different areas of the stadium in Standard Definition (SD), High Definition (HD), or both.

Cisco StadiumVision is purpose-built for sports and entertainment venues, which have extensive video systems deployed throughout, and is designed to enhance the viewing of live events and to provide in-house advertising. In addition, it leverages video systems in restaurants, clubs, and luxury suites to allow fans to view both in-house programming as well as external network channels.

Cisco StadiumVision can help sports executives and venue operators:

- Create personalized experiences to increase fan loyalty, differentiate the venue, and extend their brand.
- Enable new, revenue-generating applications for advertising, ticketing, merchandising, and concessions.
- Gain the flexibility to easily support new types of events.
- Streamline event-day operations, improving staff productivity and responsiveness.
- Create more secure, efficient, and cost-effective venues.

Cisco StadiumVision Components

Cisco StadiumVision comprises four major components, as shown in [Figure 1](#):

- Video acquisition (or video headend)
- Converged voice, video, and data high-speed IP network (Cisco Connected Stadium network)
- Video delivery (and signage playback)
- Centralized management and operations

Figure 1. StadiumVision Major Components

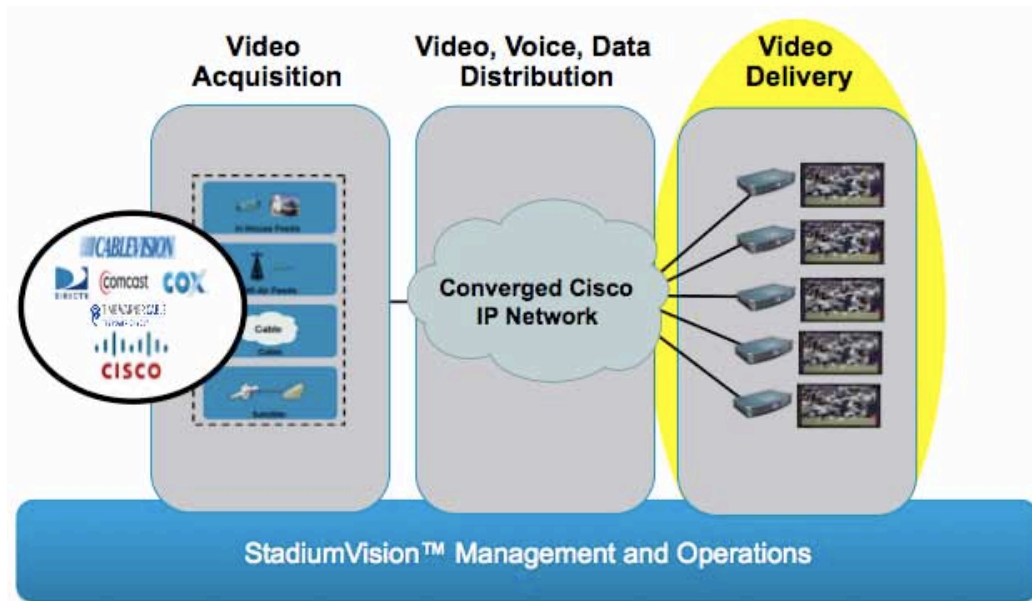

This design and implementation guide focuses on the video delivery component (highlighted in yellow in [Figure 1](#)), which is comprised of DMPs and their connections to control TVs. The video delivery component of Cisco StadiumVision enables central control of the TVs and other video displays throughout the venue using a Cisco Digital Media Player (DMP).

Video Delivery Overview

Each TV requires a DMP that is individually addressable for targeted ads and content. The DMP combines HD video and signage, and is centrally controlled by the Cisco StadiumVision Director application. The video channel can be MPEG 2 or MPEG 4 video via IP multicast. The specific TV channel, screen template/ads, and the event script control what video is displayed. TV on/off, volume, etc. is controlled via an RS-232 connection between the DMP and TV. The DMP 4310G is powered via Power over Ethernet (POE) from the switch.

Figure 2. Video Delivery

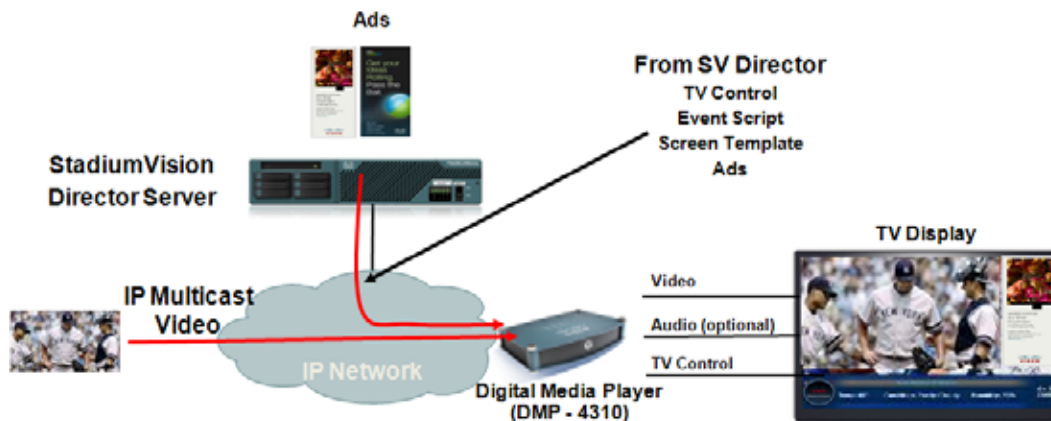

DMP 4310G Hardware

Each TV in a StadiumVision venue is connected to a Cisco DMP. The Cisco DMP is a highly reliable IP-based hardware endpoint for video decoding and playback of digital media content, including high-definition live broadcasts or on-demand video, flash animations, text tickers, and other Web content-across digital signs. It provides the interface between the local control devices, StadiumVision Director, the IP network, and the TV.

The Cisco DMP provides customized video to attached standard and high definition television displays and also provides administrative functions such as turning televisions on and off to save power.

Each DMP is individually addressable for targeted ads and other content, combining HD video and signage. Using Cisco StadiumVision Director—the centralized management system component of the StadiumVision solution—you can flexibly and remotely publish centralized content to networked digital displays. You can attach the Cisco DMP to virtually any on-premises digital TV at any location across the venue such as a concourse, club, luxury suite, or back office.

The DMP provides the following capabilities:

- High-definition (HD) media playback.
- RS-232 serial communication to the attached TV for control operations such as turning power to the TV on and off, volume control, contrast and brightness settings.
- Remote management of digital TVs.
- Full-screen, ad wrapped, and overlay video via multicast channel feeds.
- Advertising playlists, display signage, and ticker information throughout the event.
- Power over Ethernet, eliminating the need for an additional power outlet and simplifying deployment.

For historical reasons two versions of the DMP 4310 exist. One shipped as a Cisco StadiumVision-specific variant with part number DMP-4310G-SE-K9, but is no longer orderable. The other is generic with part number DMP-4310G-52-K9, and this is now the only variant that is orderable. The hardware for the two is identical.

The firmware loaded at the factory is different for the two 4310 variants. The DMP-4310G-52-K9 ships with the DMS 5.2.x firmware, while the DMP-4310G-SE-K9 shipped with Cisco StadiumVision-specific SE2.y.z firmware. Both hardware variants are able to run both flavors of firmware.

These two 4310 firmware versions are supported with Cisco StadiumVision Director Release 2.4:

- SE2.2.2 build 2744
- DMS 5.2.3 build 2812

What Comes in the Box?

- HDMI cable
- RS-232 Cable
- IR Extender Cable
- Audio Cable
- License and safety documents

Note: Power Supply and IR Remote are sold separately.

Figure 3. Cisco 4310G Digital Media Player & IR remote



DMP 4310G Rear Panel

Figure 4. Cisco 4310G DMP Rear View

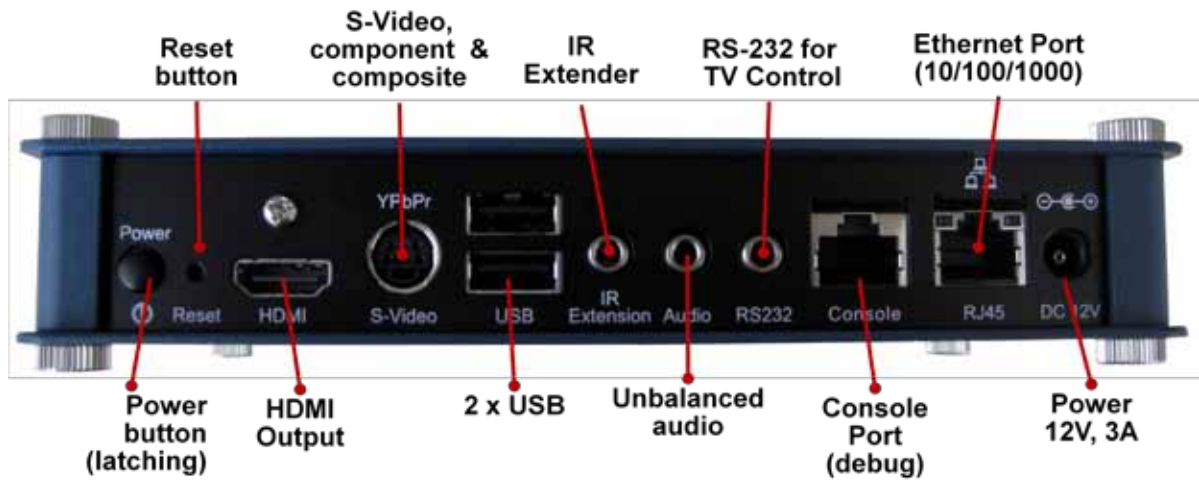

DMP 4310G IR Remote

Figure 5. Cisco 4310G DMP IR Remote



Table 2. IR Remote Button Map

| Port | Usage |
|------------------|--|
| Power Button | Turns power to the DMP 4310G on/off. This is a latching push button. |
| Reset Button | Resets the DMP to factory defaults. |
| HDMI Output Port | 19-pin HDMI 1.1, supporting up to 1080 p, progressive and interlaced video |

| | |
|---------------------------------|--|
| S-Video Component and Composite | 7-pin S-Video port supports S-Video, Component and Composite video output. The S-Video port accepts a standard 4-pin S-Video cable for S-Video output. Component and Composite video output require a proprietary cable. |
| USB Ports | Connect to a USB device for additional ad or other storage. There is 32 GB onboard storage for the DMP 4310G. |
| IR Extender | 3.5 mm IR Receiver Extension. Connects to the included IR Extender to extend IR control. This is used in situations where the DMP is mounted behind the TV such that the IR sensor is not visible. |
| Unbalanced audio connector | 3.5 mm stereo jack that provides an audio connection. |
| RS-232 Port | 3.5 mm jack for the included RS-232 cable for TV control. |
| Console Port (debug) | RJ-45 serial port for connecting to a console PC terminal. Cisco TAC use only and requires a special cable. The port does not work like a Cisco IOS Router console port. |
| Ethernet Port | 10/100 Mbps RJ-45 Ethernet port |
| Power Port | 12V, 3 amp power input. Connects the DMP 4310G to power. Note that the voltage and amperage rating for this port is different than the DMP 4305G power port. Therefore do not connect a DMP 4305G power supply to this port. |

DMP 4310G Software Architecture

The DMP4310G is an embedded Linux device that uses a number of protocols for communication with StadiumVision Director and the Adobe Flash Lite player for mixing of the video and graphics that are displayed on the TV.

Figure 6. Cisco 4310G Software Architecture Overview

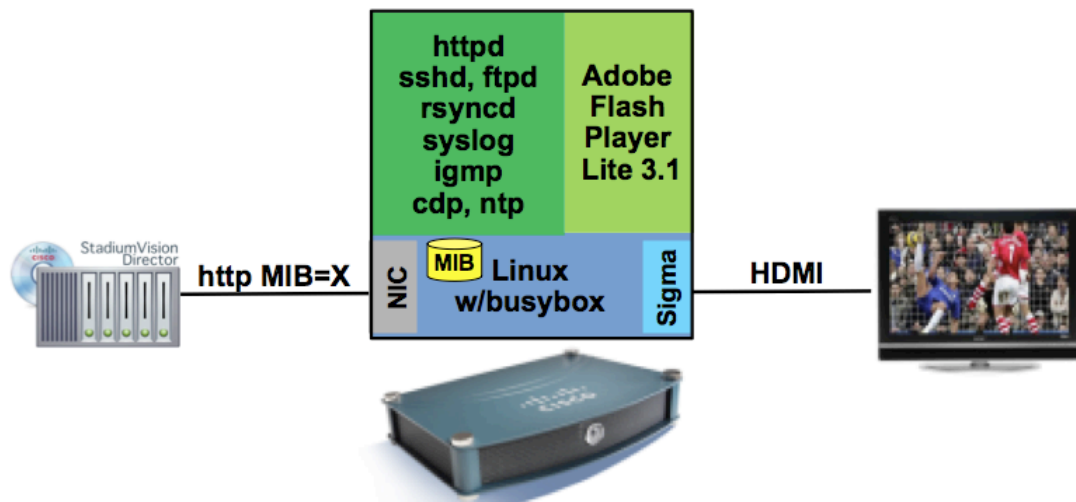

- **SWF = ShockWaveFlash**
- **SWF files are executable files that run in Adobe Flash Player.**

Content Delivery

As illustrated in [Figure 7](#), graphics and video are displayed by the DMP as follows:

1. StadiumVision Director pushes a flash template that is used for framing and displaying the ad graphics and video on the TV. There are two standard templates used: 1920x1080 for the DMP 4310G and 1366x768 for the DMP 4305G.

Note: The graphics are created to fit the specified template and are staged on the DMP. See the [Cisco StadiumVision Content Creation Design and Implementation Guide](#) for details on the templates supported by the DMP 4310G and the DMP 4305G.

2. An event script is created that includes custom display layouts at different game states (pre-game, post-game, etc.). These display layouts are displayed on the TV during their specified game state.
3. Video channels from the head end are pre-provisioned on multicast groups and are available for playback on the DMP when the DMP joins the associated Multicast group.
4. The TV notifies the DMP of its supported HDMI formats with its preferred format (i.e., the native resolution of the TV).

Note: The TV may support a format different from its preferred format; however, it will display a resolution no higher than its native resolution. The TV will scale the picture to fit.

5. The DMP combines the graphics and video and sends it to the TV for display.

Figure 7. Displaying Graphics and Video on the DMP

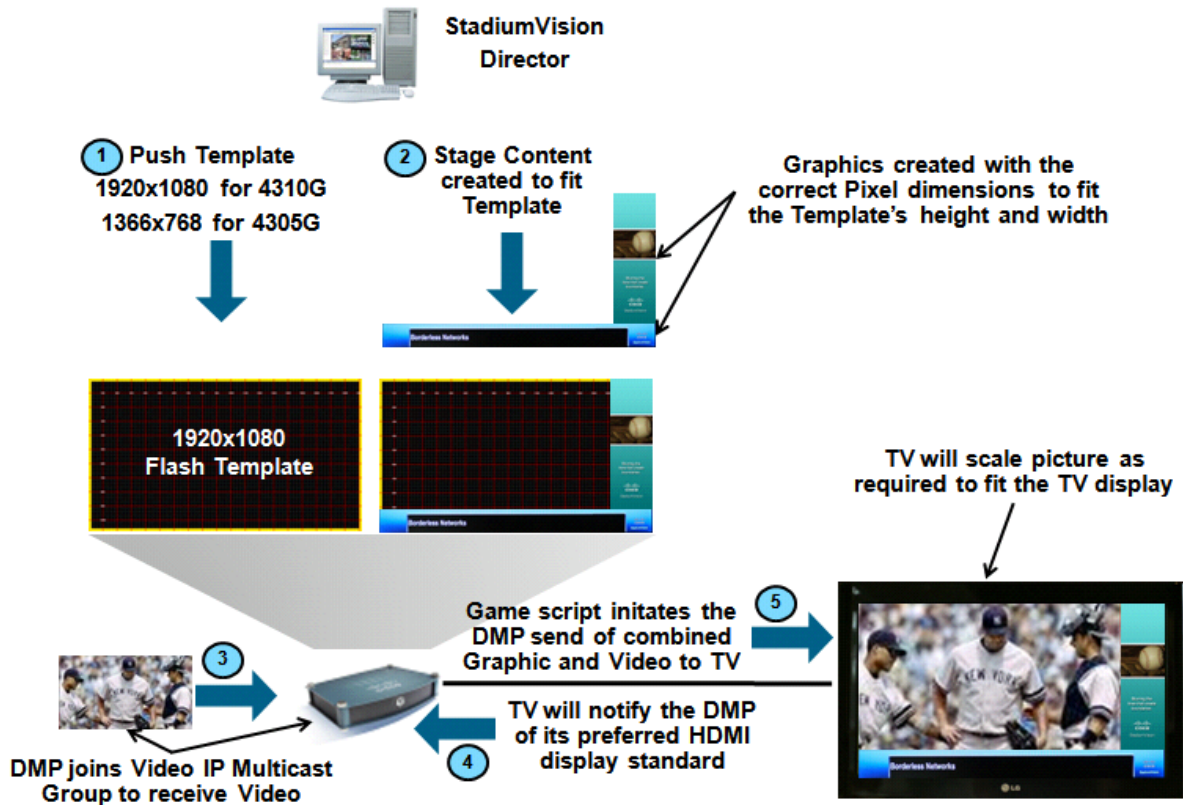

Chapter 2 Planning

This chapter covers recommended TVs for use with StadiumVision, DMP-to-TV connections, DMP mounting specifications, and video wall design considerations.

TV Recommendations

In most cases, DMPs can use TVs that comply with modern, international standards. The following TV features and characteristics are recommended for a StadiumVision deployment:

- Display Technology: LCD
- Display Size: 32 in. or greater
- Video Input: HDMI or DVI
- TV Control: RS-232 (mandatory)
 - Automatic Volume Control (normalizes channel and commercial volume)
 - Discrete Power ON and Power OFF codes
 - Support for Discrete Volume/Mute Controls
 - Retrieve TV status (on/off, firmware ver., S/N, etc)
- Matrix Support: For Video Wall Support
- Wall Mounting: VESA compatible
- If Suite TV, Front AV inputs for other devices (e.g., Gaming system) and PC input for showing presentations.
- Digital, not analog.
- High-definition, not standard-definition.
- Commercial-grade, not consumer-grade. Digital signs and public IPTV installations run many more hours each day than a consumer-grade TV is engineered to run. A consumer-grade system is likely to fail years sooner than a Commercial-grade system would under these circumstances.



Most often, content is web-based or animated in flash. The nature of these media types means that some pixels are not updated frequently in digital signage. LCDs are less susceptible to burn-in than plasma displays are. Although image persistence is

sometimes a problem on LCD displays, it is almost always self-correcting and is unlikely to occur if you follow manufacturer guidelines for managing your displays correctly.

Considerations When Planning TV Purchases

- If using DVI for video and audio is required, you need separate audio wiring from the DMP to the TV's built-in speakers or to an external sound system.
- If the TV is in a luxury suite or conference room, etc, and you want to allow customers to plug their PCs into the TV to make presentations, you need a PC input on the TV.
- If the TV is in an area where you want to allow customers to connect external devices like a gaming system to the TV, purchase a TV that has easily accessible front video and audio jacks.
- If advertisement will be displayed along with video, for best visibility, purchase TVs with at least a 32-inch diagonal display size.
- If the TV is going to be part of a video wall, purchase a TV that has a matrix mode or is designed for use in a video wall and one with a small bezel to minimize the gap between TVs.
- Assuming the TV will be mounted on a wall, purchase TVs that are VESA mounting compliant.
- Centralized control is very important when controlling hundreds or thousands of TVs. Controlling TVs from StadiumVision Director via RS-232 control is highly recommended. The TV should have discrete RS-232 codes associated with operations like power on, power off, and absolute volume settings.
- Some TV displays provide the ability to lock-out control of the physical TV-setting buttons and IR remote. This may be used to avoid mis-configurations by non-qualified personnel.
- If the TV will be mounted outdoors, displays that are built to withstand the elements should be purchased. TVs with weatherproof compartments for the DMP is also a way to avoid the cost of an additional enclosure.

Outdoor TV Options

Ruggedized TV's are needed in areas that are exposed to weather. Sunbrite is one of a number of companies that specializes in ruggedized TVs. Cisco does not recommend one vendor over the other. If ordering Sunbrite 4610 make sure to order the larger door option on the rear compartment as well as extra cooling fans.

Figure 8. Outdoor TV Options

Outdoor TV Options

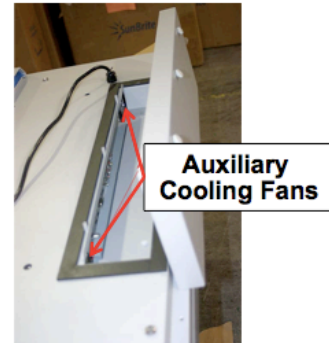
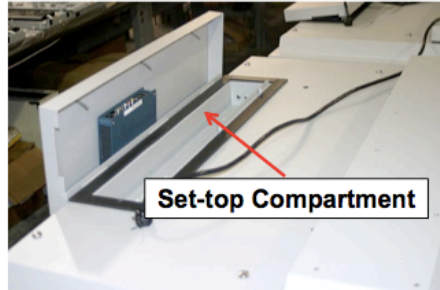

- Sunbrite 4610 – built-in set-top compartment
- Quad-fan Airflow System keeps the unit cool and dry in temperatures up to 122 degrees F.
- Internal Heater protects TV in temperatures as low as -24 degrees F.
- Water-tight Cable Entry System with pass-through design keeps cables dry and allows for easy hook-ups.

© 2011 Cisco Systems, Inc. All rights reserved. Cisco Confidential

9

DMP and TV Mounting Options



Träger IIa (custom)



Chief FCA100



Cisco DMP mount
DMP-PRCASE-4305-S1

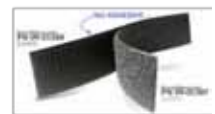

Velcro

After you have worked out all of the specifics of the connectivity per the instructions in this guide, it is recommended that you create diagrams and instructions that detail the exact mounting of the physical brackets, the DMP housing and the cable connectivity. DMP and display mounting design and installation should be coordinated with the customer's installation contractor.

You should plan to install the DMP and the TV at the same time since there is often tight fitting and millwork to work around and it is easier and cheaper to do it all at once. Rigid mounts are much preferred to Velcro or other adhesives, as these can withstand the continuous heat radiation from the DMP.

The following three DMP mounting options have been implemented successfully at various Cisco StadiumVision sites:

- [Cisco Träger Mounting Bracket \(custom\)](#)
- [Chief FCA100 DMP Mounting Brackets](#)
- [Cisco DMP Mounting Kits](#)

Cisco Träger Mounting Bracket (custom)

A custom “Träger” mounting bracket designed by Cisco Systems is available for attaching the DMP to the TV. The Träger bracket has the following features:

- Inexpensive
- Manufactured from light-weight, but durable, material
- Custom-designed to fit the DMP 43xx form factor
- An optional method to secure the DMP from removal
- Easy access to the TV/DMP rear panel and cabling
- Lateral ventilation slots on three sides to allow airflow through the DMP

You can attach the Träger bracket to the TV using Velcro or another semi-permanent/permanent fastener (see the “Velcro Mounting” section). The Velcro is applied between the rear of the TV and the back of the Träger bracket rather than directly to the DMP. This design securely attaches the DMP to the TV or any surrounding millwork, while allowing the DMP to easily slide out of the Träger for servicing.

For best cooling do not mount the DMP with the front mesh facing downward. Instead insert the DMP into the bracket with the bottom (non-Cisco logo side) facing away from the TV or wall.

The Träger bracket is manufactured upon request by Triangle Stainless Inc. For pricing and lead times contact them via their web site www.trianglestainless.com.

Specifications

Material: 1.59mm (0.0625”) Stainless Steel

Dimensions: 182.778mm (7.196”) x 149.428mm (5.883”) x 41.631mm (1.639”)

Figure 9. Träger IIa Mounting Bracket



Chief FCA100 DMP Mounting Brackets

The Chief FCA100 mounting brackets shown in [Figure 10](#) have also been proven effective for mounting a DMP to the TV. For instructions on how to install the brackets, refer to the Chief Manufacturing Installation Guide at <http://downloads.chiefmfg.com/MANUALS-I/FCA100-I.pdf>.

Figure 10. Chief FCA100 Mounting Brackets



Specifications

Part Number: FCA 100

Dimensions: 27.3mm(1.07") x 152.4mm(6") x 47.2mm(1.86)

Cisco DMP Mounting Kits

Cisco offers a DMP Mount Kit support that supports four different mounting options: wall mount, display mount, ceiling mount, and pole mount. Other features include a security locking option and clear airflow for ventilation. Refer to [Figure 11](#).

Figure 11. Display VESA mount illustration

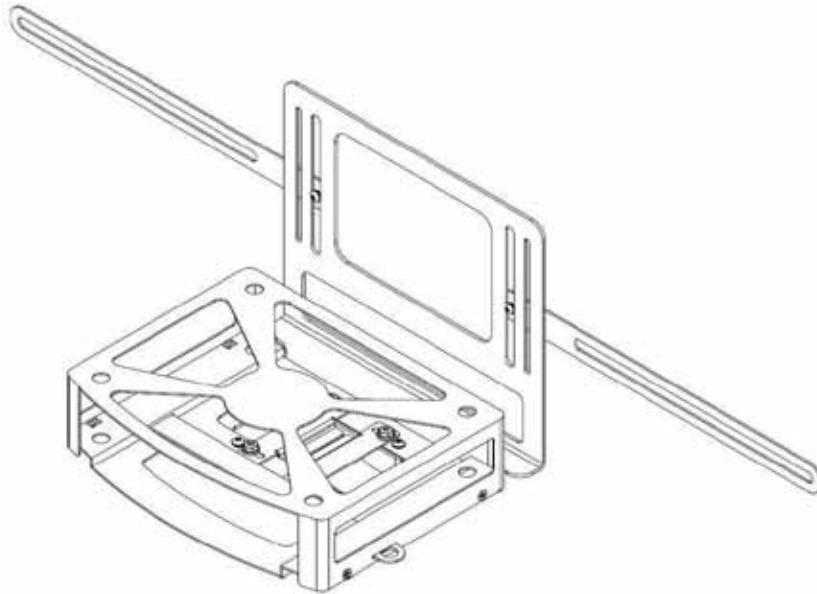
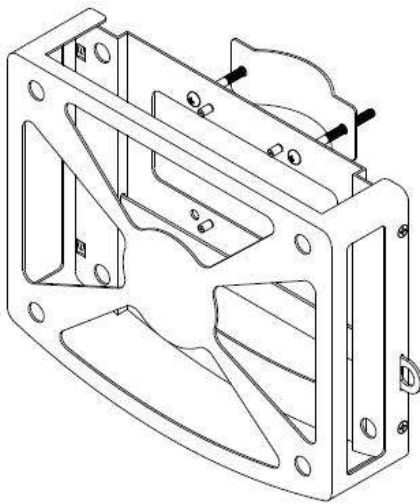

Figure 12. Pole mount illustration



Specifications

Product Name: Cisco DMP 4305/4310G Protective Case Mount, Series 1

Part Number: DMP-PRCASE-4310-S1

Dimensions: 1.65 x 7.41 x 5.335 in. (4.19 x 18.82 x 13.55 cm)

TV Mount Kits

The type of TV mount kit you use depends upon the TV model/manufacturer and the TV location (fixed, swing arm or tilting wall mount, or a ceiling mount). Chief[®] Professional Mounting Solutions (www.chiefmfg.com) offers a broad range of universal and custom flat panel TV mounts that are fast and easy to install. Use the Chief's MountFinder Pro feature on their website to quickly find Chief product information and compatible mounts for specific flat panel TVs.

DMP Power Options

Power over Ethernet (PoE) is the recommended option for powering the DMPs. If you use PoE, ensure that the DMP is connected to a recommended IDF switch, as prescribed in the *Connected Stadium Design and Implementation Guide*.

Chose a switch that supports full 802.3AF power for the number of switch ports that have been designated for DMPs.

The following illustration shows options for providing power the DMP.

Figure 13. DMP Power Options

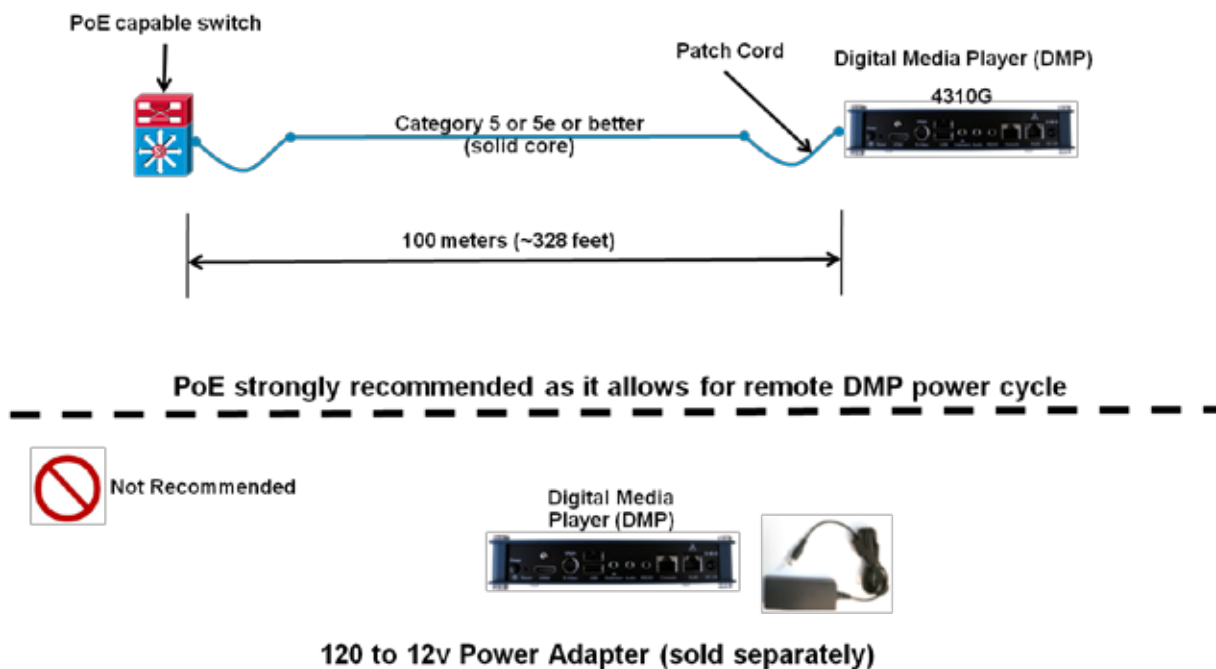

UTP Cable Runs

The DMP connects to a Cisco Connected Stadium network via a UTP cable connection from the Ethernet RJ-45 port on the rear panel. A minimum quality cable of Category 5 or higher Unshielded Twisted Pair (UTP) should be used for DMP connections with the total cable length not to exceed the IEEE recommended 100

meters. Cable lengths exceeding 100 meters may cause instability when using Power-Over-Ethernet (POE) to power the DMP 4310G.

DMP to TV Connections

As shown in [Figure 14](#), there are primarily three connections when connecting a Cisco DMP to a TV: video, audio, and TV control. Audio is optional as it may not be required at the TV location or it may be a component of the digital data stream carried over the HDMI connection.

Figure 14. Real World DMP to TV Video and Audio Connection Options For HD Deployments

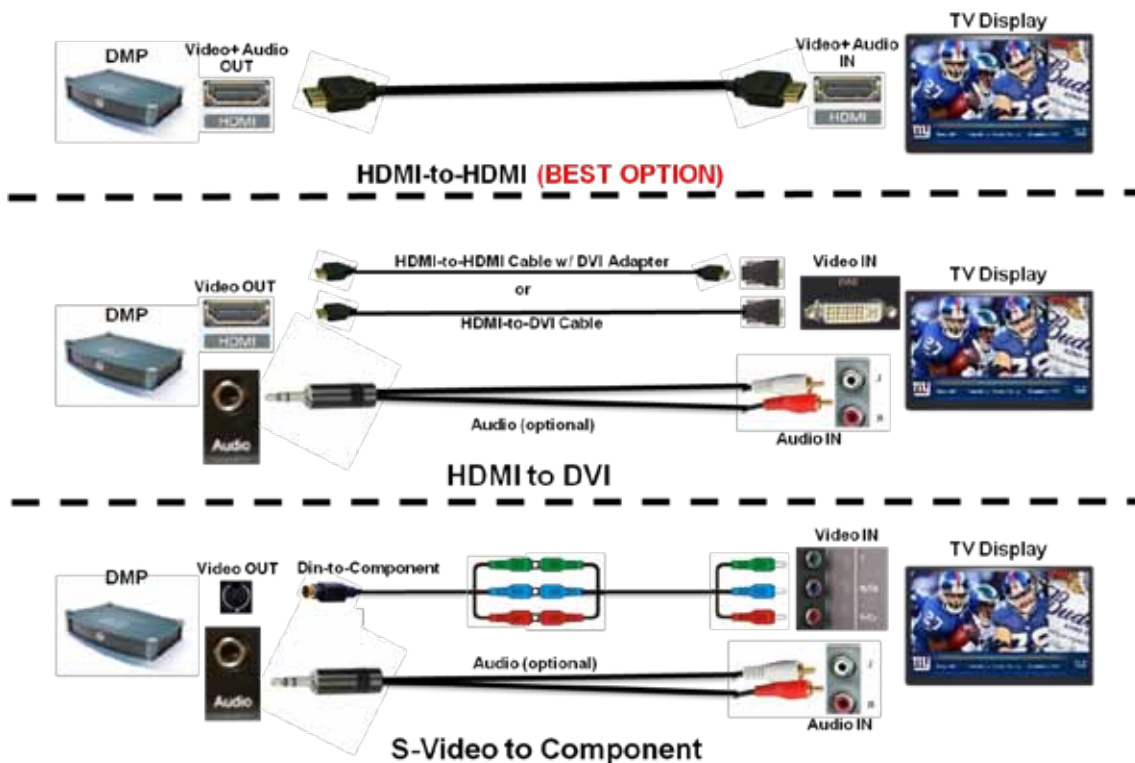

HDMI to HDMI Connection

[Figure 15](#) shows the HDMI-to-HDMI connection. This connection is the simplest of the options where video and audio are carried together over a single HDMI cable.

Figure 15. HDMI-to-HDMI



HDMI to DVI Connection

Some TVs only provide a DVI interface. Therefore, if you plan to use the included HDMI cable, you will need to purchase an HDMI-to-DVI adapter cable to connect to the TV's DVI-D port. Another option is to purchase an HDMI-to-DVI cable as shown in [Figure 16](#).

Figure 16. HDMI-to-HDMI with DVI Adapter

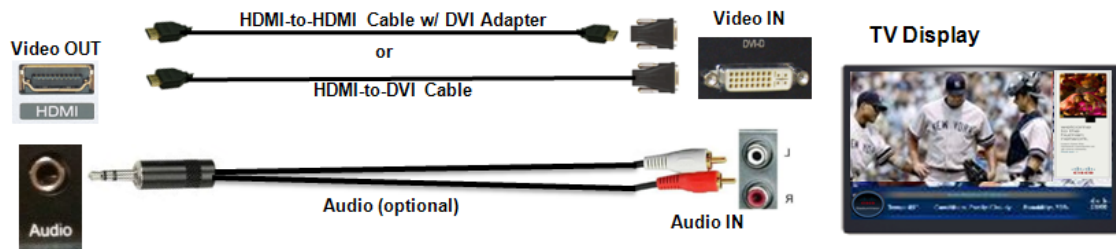

DVI carries only the video signal and therefore, if audio is required and the TV offers audio inputs, separate audio cables between the DMP audio output jacks and the TV's audio output jacks are required.

Note: DMP audio output may connect to external audio distribution equipment if audio is to be distributed within an area.

DMP to TV Component Connection

Venues typically require a small number of component connections to accommodate special devices like projectors or older displays. The DMP uses a Cisco non-standard DIN-to-Component cable to support these devices. This cable is not included with the DMP 4310G. For pin-outs and cable schematics please see [“Appendix A: DMP Connector Pin outs and Cable Schematic.”](#)

Figure 17. S-Video to Component Connection

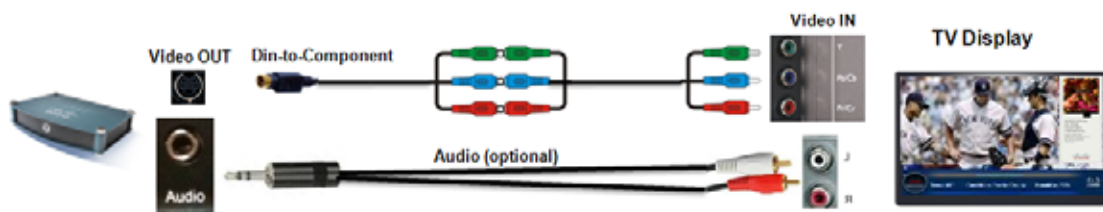

If using a DMP S-video output to component convertor cable, you need to configure the DMP to enable the component interface. This can be done via the Display Actions web page on the DMPDM interface, or by directly addressing the DMP MIB.

The following screen shows an example configuration of a DMP connected via the component cable with the 1080i59 as its Display Standard. Other Display Standards may be used for different TV models.

Figure 18. Setup to enable 1080i Component Output from the DMP 4310

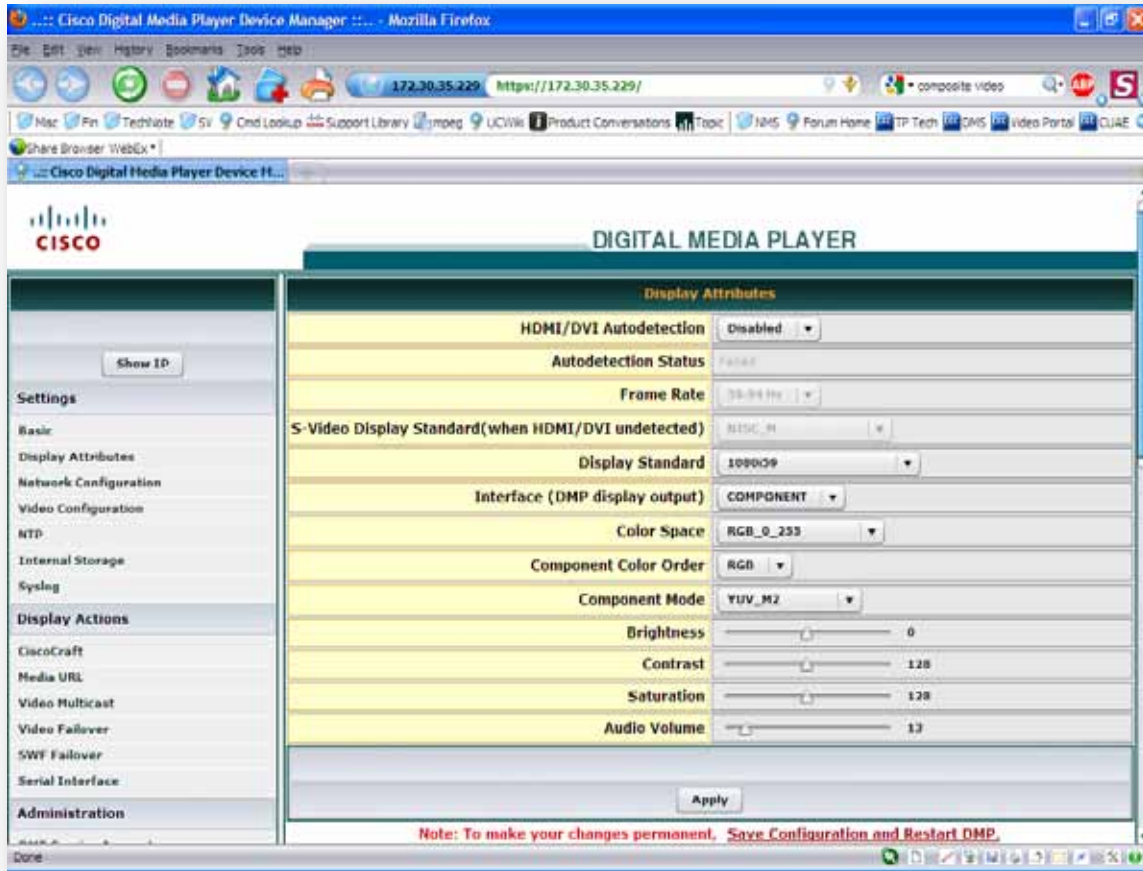

DMP to TV Composite Connections

The composite connection shown in [Figure 19](#) is typically deployed in legacy environments with older tube TVs. Full screen video is recommended since ad wrapper graphics display at rather poor quality (4:3 Aspect ratio of TVs will effect Ad Wrapper graphic quality). Note that these older TVs will deliver analog quality video to the TV even if the rest of the venue is in HD.

Figure 19. Composite Connection for Legacy TVs

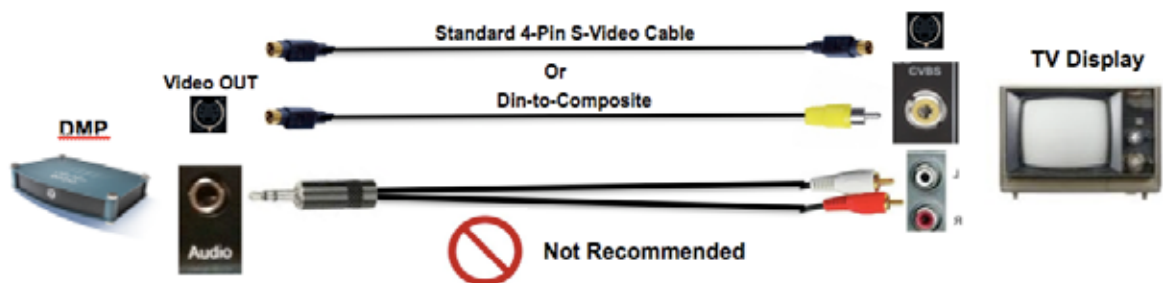

Figure 20. Alternate Composite Connection for Legacy TVs using Din-to-Component Cable on the 4310

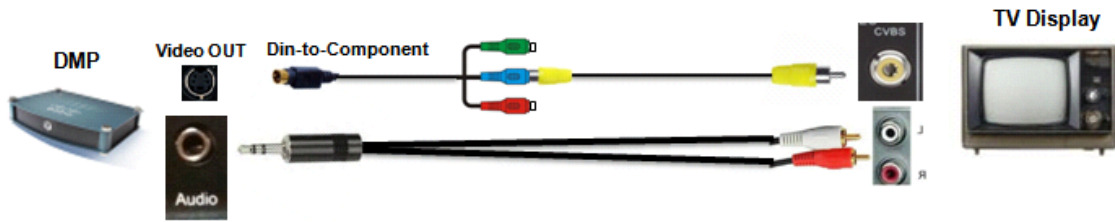

Figure 21. DMP Configuration for S-Video and Composite Connections

| DIGITAL MEDIA PLAYER | |
|--|---------------------------|
| Display Attributes | |
| HDMI/DVI Autodetection | Disabled ▾ |
| Autodetection Status | Failed |
| Frame Rate | 59.94 Hz ▾ |
| S-Video Display Standard(when HDMI/DVI undetected) | NTSC_M ▾ |
| Display Standard | NTSC_M ▾ |
| Interface (DMP display output) | SVIDEO ▾ |
| Color Space | RGB_0_255 ▾ |
| Component Color Order | RGB ▾ |
| Component Mode | YUV_M2 ▾ |
| Brightness | <input type="range"/> 0 |
| Contrast | <input type="range"/> 114 |
| Saturation | <input type="range"/> 151 |
| Audio Volume | <input type="range"/> 13 |
| Changes applied. | |
| <input type="button" value="Apply"/> | |

DMP TV Control Connections

StadiumVision Director controls what is displayed on the TVs and also controls the TV settings (e.g., turning the TV on or off, setting volume level, etc.). StadiumVision Director sends commands over the IP network to the DMP. The DMP then sends those commands to the TV via the RS-232 port of the DMP. There are two primary ways to transmit those commands to the TV: a direct RS-232 cable connection or an Infrared connection. The infrared option requires the addition of an RS-232-to-Infrared (IR) adapter to make the command signal conversion from RS-232 to IR.

Note: As another alternative for TVs that do not provide an RS-232 port, certain commands (such as volume and mute) can be issued directly to the DMP using the DMP Sigma commands. Refer to the [“Serial Commands for TV Volume Control”](#) section in Chapter 4 for details.

Using a Direct RS-232 Connection

Making a direct RS-232 connection between the TV's RS-232 port and the DMP's RS-232 port provides the simplest and most reliable way to remotely control the TV. RS-232 is typically provided on commercial-grade displays that are recommended for the Cisco StadiumVision solution.

The DMP 4310G uses a 3.5 mm audio jack for the RS-232 connection. The DMP has three 3.5 mm audio jacks side by side so make sure to connect the correct one. The DMP 4310G ships with a 3.5mm to 9-pin female DCE cable that connects to this port.

The DMP 4305G uses a standard 9-pin D-Sub (male) serial port (DB-9) for the RS-232 connection.

The default port configuration for both 4305 and 4310 is 9600/8/N/1, with no flow control.

Guidelines for RS-232 Cables

Careful consideration must be made before buying RS-232 cables for connecting the DMP to the TV. Things to note are the gender and type of connector on the TV and wiring configuration for the connector. The TV may have either a DB-9 or RJ-45 connector and be wired as a straight or null modem cable (i.e., TX and RX pins are swapped). Check with the manufacturer of the TV's manual for this information before purchasing cables.

[Figure 22](#) illustrates the two types of 3.5mm stereo port-to-TV connections for the DMP 4310G. Refer to "[Appendix A: DMP Connector Pin outs and Cable Schematic](#)" for details about the 3.5mm RS-232 port.

Figure 22. RS-232 for TV Control (DMP 4310G)



[Figure 23](#) illustrates the two types of DB-9 connections for the DMP 4305G.

Figure 23. RS-232 for TV Control – DB9-to-DB9 (DMP 4305G)

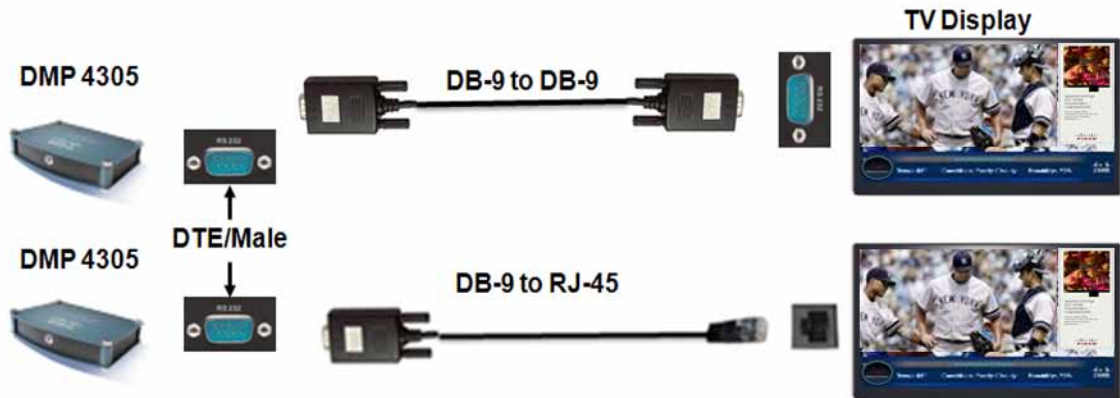

Using an RS-232-to-IR Adapter Connection

If the TV does not have an RS-232 port, which is typical for consumer grade TVs, an RS-232-to-IR adapter is required. Although this approach is strongly discouraged, you can use the Jafa SCIRTx RS-232 to IR adapter. [Figure 24](#) and [Figure 25](#) illustrate the RS-232-to-IR Adapter connections for the DMP 4310G and DMP 4305G, respectively.

One disadvantage of using an RS-232-to-IR adapter (besides added complexity) is that you must use an adhesive to affix the IR sensor to the TV. There is a good chance that the adhesive, if exposed to weather or due to age, will pull away from the TV's IR sensor. This results in loss of TV control and possibly the use of ladders and personnel to re-adhere the sensor to the TV.

Figure 24. IR for TV Control (DMP 4310G)

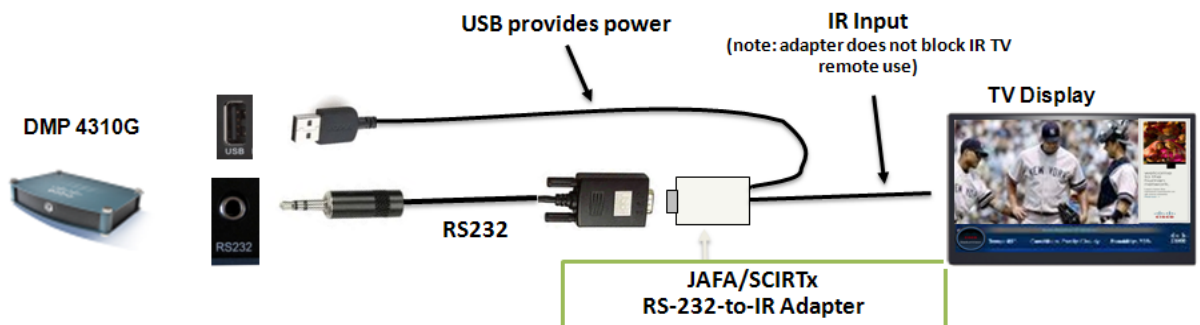

Strongly Discouraged – Fragile – TV status cannot be retrieved

Figure 25. IR for TV Control (DMP 4305G)

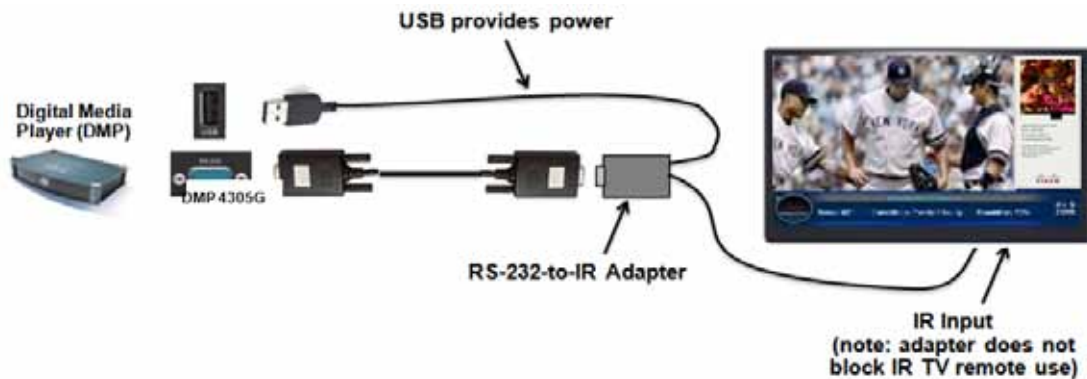

IR Remote Sensor and IR Extender

If the DMP is mounted behind the TV such that the IR sensor is not visible for IR remote control then the included IR extender may be used to extend IR control. The IR remote is an important troubleshooting tool so it is important to ensure that all DMPs can be IR controlled even if this is not needed during normal operation.

DMP and TV Location

Introducing Locations

There are three object types that are used in Cisco StadiumVision Director to track and create relationships between DMPs and their physical location. These object types are as follows:

- **DMP** – This object type describes a DMP with the following information.
 - **Name** – This is the name that describes the DMP. Typically it's name derived from the MAC address (e.g., Unassigned-00-0f-44-01-a5-ec) or the Location Name.
 - **Description** – Optional field for additional description information
 - **IP Address** – DMP IP Address
 - **MAC Address** – DMP MAC Address
- **Location** – This object type defines the physical location where the DMP is located with the following information.
 - **Name** – This is the name used to identify the location and is derived from a naming convention that an operator can easily identify where the DMP is physically located.
 - **Description** – Optional field for additional description information
 - **Location ID** – Optional field for additional location information. Typically this would be where blueprint location IDs would be inserted. This information is not always user-friendly for easy location identification.
 - **Display Spec** – Drop-down menu for choosing the TV Type at the location
- **DMP+Location** – This object type is the summation of the two above objects when linked.

These object types can be created manually using the Cisco StadiumVision Director web interface or uploaded in bulk using the Bulk Administration Tool (BAT).

Location Naming Convention

In StadiumVision Director, the concept of Location is the identifying name of the physical location where a TV and DMP is located within the venue. See [Figure 26](#).

Figure 26. Location Definition in StadiumVision Director

Location

- Specific place in the stadium where a TV and DMP reside



The SVD Location object has both a **Name** and a **Description**. The established best practice is to use a structured ID for the Location Name and a user-friendly text string for the Location Description.

The optimal naming convention will vary from venue to venue, depending on size and layout. However, some recommendations can be provided for how to best create a systematic naming convention.

Below are some basic guidelines that can be used.

- Use floor or concourse levels.
- Use absolute references, i.e., North, South, East and West
- Use a numeric suffix to differentiate between otherwise identical locations.
- Use generic names that are unlikely to change over time.
- Sponsors come and go, so avoid using a sponsor's name in the Location.

- Sponsor and room names are best captured as part of the Location Description, where they can be added, modified or deleted at any time without affecting the Location to Group mappings.
- It is recommended that labels with the Location Name be attached to each TV in the venue. This simplifies identifying a problem TV and searching for it in the Cisco StadiumVision Director management dashboard. Printing the Location Name in both textual and bar code format allows the label to be scanned during the install process. See the discussion around bar code scanners in the BAT section.
- Names should only use “A-Z”, “a-z”, “0-9”, space (), underscore(_) and dash (-)
- These are invalid characters and should be avoided: % * , : ? = / \ " ' [] () +

A possible Location Name for the 20th display in the North East corner of Concourse 100 could be: 100-NE-020

The SVD Location concept should not be confused with the Civic Location that Cisco Catalyst switches support. An introduction to Civic Location is provided in [“Chapter 4 Tips and Best Practices”](#).

Closed Captioning

Support for closed captioning (CC) is provided as per EIA-608-B, now CEA-608-E (VBI line 21 CC data services) and EIA-708-D (DTV CC standard). In addition, per Cisco Sports and Entertainment customer requirements, the proprietary CC specification from Direct TV, “DirecTV proprietary IRDA VC CC Specification Version 1.3,” is also supported. The Sigma SoC will decode and display the CC information as directed by the source encoder. Refer to [Figure 27](#).

These standards apply to North American installations. Closed captioning will not work in Europe or anywhere outside of North America.

Figure 27. Closed Captioning

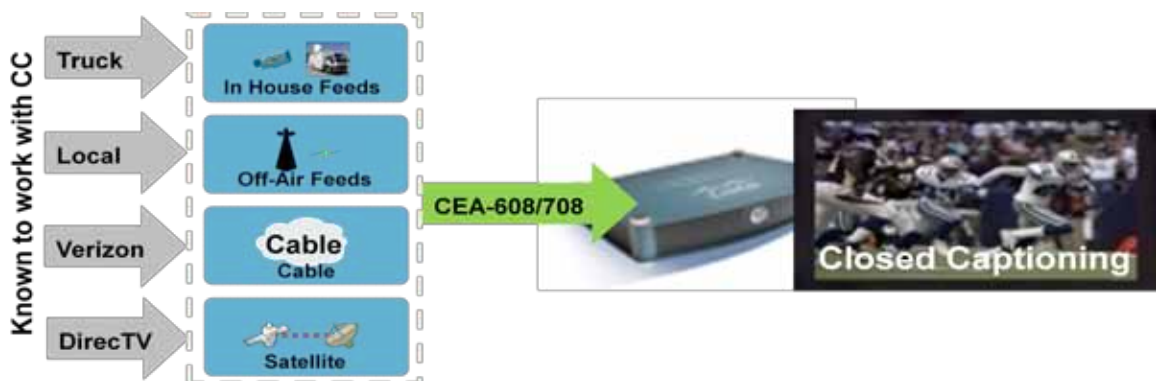

Video Wall Design

Often a customer will have a requirement for video walls. Video walls allow multiple smaller screens to show synchronized content and give the illusion of a single much larger screen. Cisco StadiumVision supports two variations of tile matrix video wall, both of which will be discussed in detail in this chapter.

A common use case for video walls is to vary the video wall layout and content over the course of an event, as illustrated in [Figure 28](#). In this particular example the video wall starts of in a 3x3 configuration showing the live game feed. During half time, when there is no live game to show, the video wall is switched to individual screen mode. Individual screens then show out of venue games that are going on right now. When 3rd quarter starts video wall mode is resumed, but now a 2x2 configuration is used. Varying the layout makes it interesting and keeps eyeballs on the screens. This is particularly important if the video wall is sponsored as in this example.

Figure 28. 3X3 Video Wall in Tile Matrix Mode

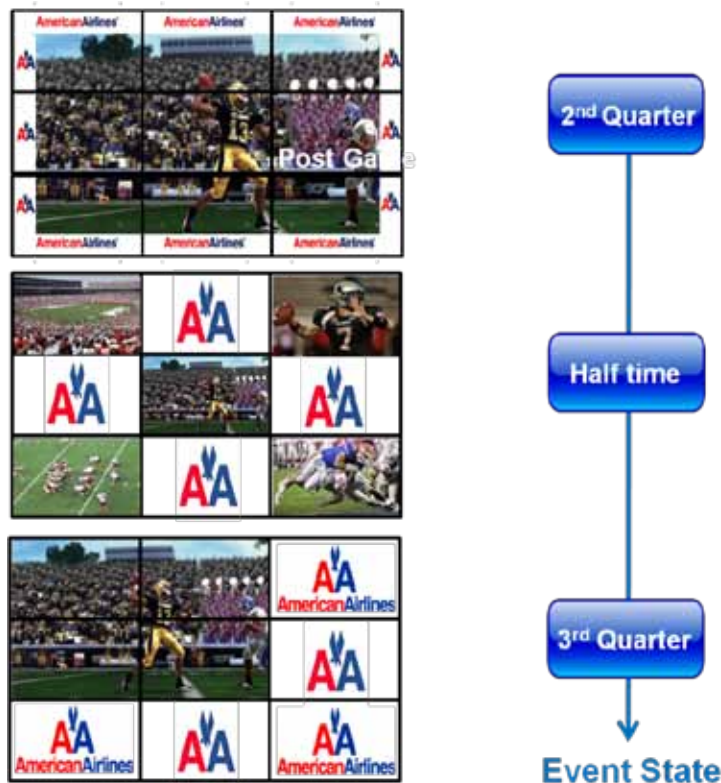

There are two options for building tile matrix video walls in StadiumVision:

- [TV-Based Tile Matrix Video Wall](#)
- [DMP-Based Tile Matrix Video Wall](#)

TV-Based Tile Matrix Video Wall

A TV-based tile matrix video wall requires the use of TVs that have built in tile matrix capabilities. The tile matrix capability is configured via RS-232 commands, which specify the overall x and y dimensions of the matrix as well as each TV's position in the video wall.

Each TV in the video wall is served by a separate DMP, and this dedicated DMP provides the video signal as well as the RS-232 control for the TV it is connected to. This approach allows each TV to display unique content when not operating in tile matrix mode.

When operating in tile matrix mode the TVs are fed the same video signal. Based on the TV's tile matrix configuration, the TV knows to first scale input video to the size of the configured x,y dimensions, then to display its "piece" of the overall display based on its configured position within the matrix.

Depending on whether the TVs in question support daisy chaining of the video signal, the common video feed for all TVs is achieved in one of two ways.

If the case where the TVs do not support daisy chaining of the video signals, an extra DMP is deployed to act as the "video wall DMP." The video signal from this DMP is routed through a splitter and to a secondary video input port on each TV in the video wall. This is illustrated in [Figure 29](#).

As an alternative to the extra DMP, a similar result can be achieved by tuning each of the nine individual DMPs to the same channel, and then set the TVs to tile matrix mode. The caveat of doing it this way is that the nine video streams must be in perfect synch for the matrix to appear as a single large virtual display.

Figure 29. Tile matrix video wall, without a daisy chained video signal

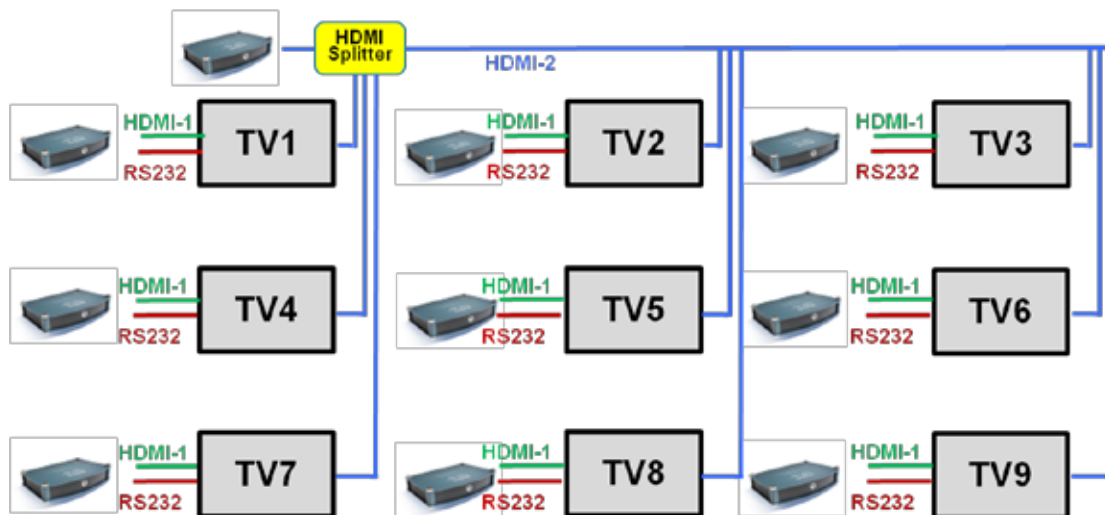

If the TVs do support daisy chaining then DMP-1 doubles as the video wall DMP. Its video signal is switched through to all TVs via the daisy chained inputs. Depending on the TV model the daisy chain is constructed using component, DVI, HDMI or in some cases even VGA. This is illustrated in [Figure 30](#).

Figure 30. Tile matrix video wall, with daisy chained video signal

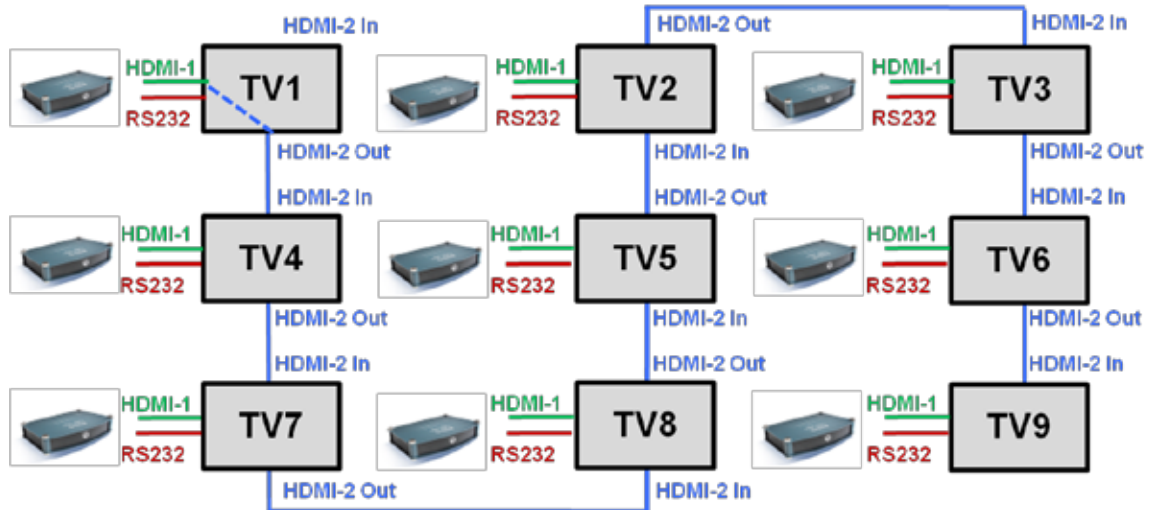

Caveats for TV-based tile matrix video walls:

When daisy chaining the video signal is that there is no conditioning of the video signal as it is propagated from TV to TV. Therefore, the signal at the last TV in the chain (usually the lower-right TV) is a little weaker than the others and requires minor tuning of the brightness, contrast and color settings on the DMP or the TV so that the picture is synchronized with the other TVs.

Tile matrix TVs require multiple RS-232 commands to switch them to and from tile matrix mode. Currently Cisco StadiumVision Director only allows one RS-232 command to be transmitted per event state; hence multiple event states are needed to switch in and out of tile mode. This means that the switch is not instant, and spectators will notice the gradual transition.

Another transition related caveat is the fact that each TV must change input when switching to/from tile mode. This results in the TVs going black momentarily and showing a small on-screen-display that identifies the new input.

DMP-Based Tile Matrix Video Wall

Beginning with Cisco StadiumVision Director Release 2.4, the DMPs have native tile matrix capabilities. This allows tile matrix video walls to be constructed without requiring expensive TVs with tile matrix capabilities. DMPs tile matrix behavior is achieved by stretching the video region in the screen template so it covers 2 or more TVs in each direction. By adjusting the X,Y coordinates for the origin of the

video region, each DMP can be made to display the correct piece (tile) of the bigger video image. This is illustrated on [Figure 31](#).

Figure 31. DMP-based 2x2 tile matrix video wall, with screen template for bottom right display.

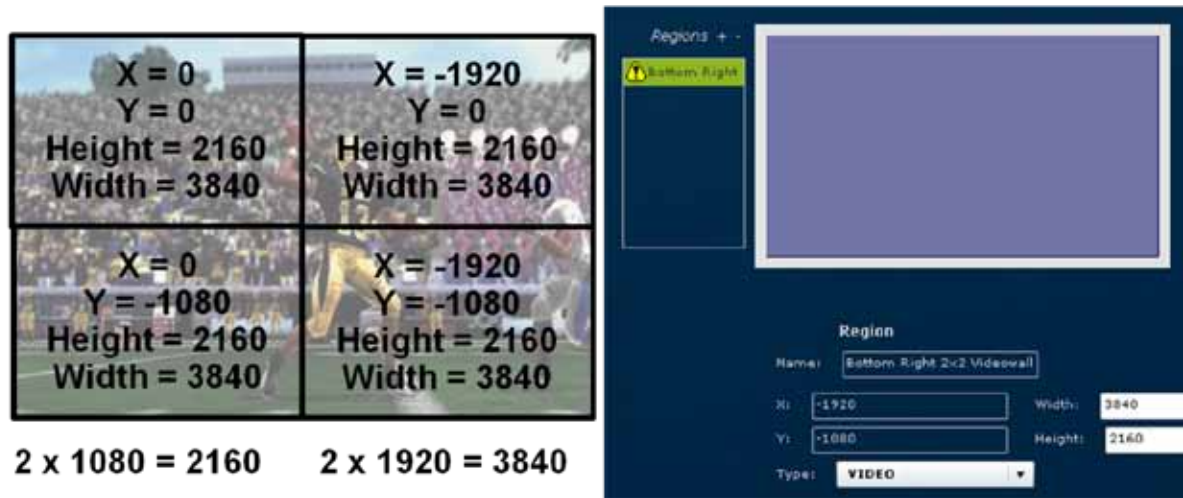

The DMP-based tile matrix is recommended only for streaming video, as all DMPs are receiving the same signal and hence remain in sync. If a video playlist is used instead of streaming video then they may drift out of sync over time.

For best results take the bezel width into account when configuring the screen template. Do this by determining the width/height of the bezel in pixels, then add two times the pixel count to the width, height and X,Y coordinates in the screen template.

One advantage of a DMP-based tile matrix over TV-based tile matrix is overlay graphics do not need to be stretched, and hence can retain HD resolution. [Figure 32](#) shows a framed 2x2 video wall, where the framing graphics are a HD quality. The video itself of course is less than HD as it is being stretched across the multiple screens. One caveat with the playlist is that all screens may not advance at the exact same time, causing the graphics to be momentarily out of sync. If perfect synchronization is an important then it is recommended to have one item only in the playlist.

Since the graphics are playlist controlled they can be varied over time.

Figure 32. DMP-based 2x2 tile matrix video wall, with screen template for bottom right display.

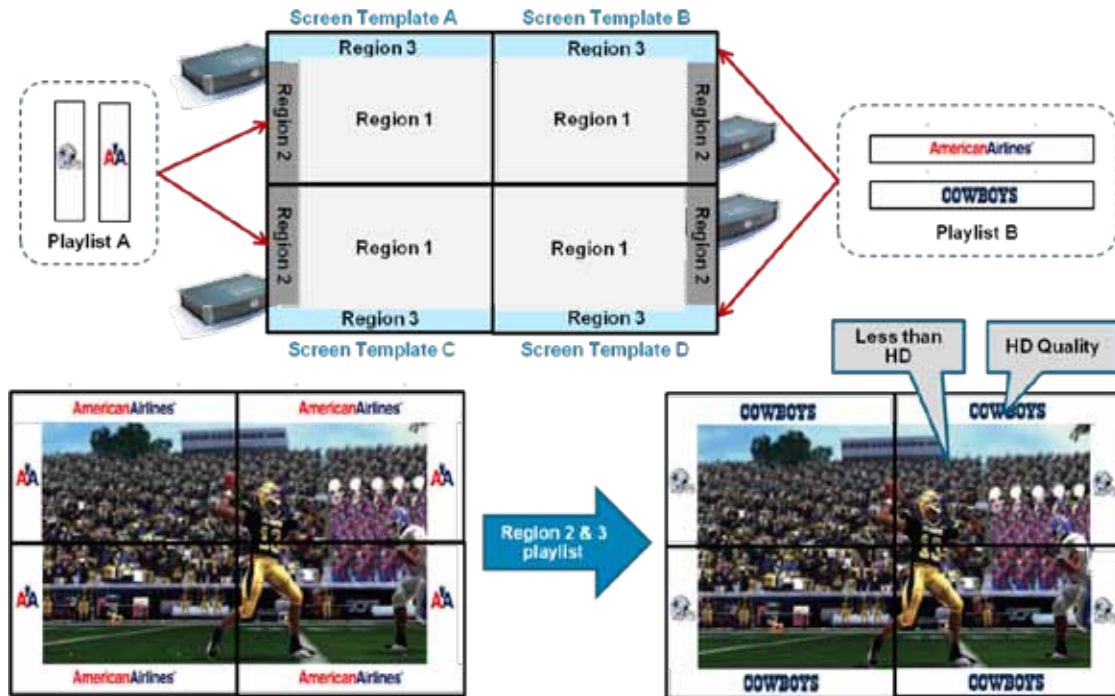

TV Qualification

Inputs on a modern TV are based on industry standards, which leads to a general expectation of interoperability with peripheral devices that adhere to the same standards. Unfortunately many standards leave room for interpretation and variation, and the experience from many Cisco StadiumVision deployments is that DMP to TV interoperability cannot be taken for granted.

The RS-232 connection is the most obvious example of a TV input where the standards are loose. Connector, pin outs and control codes all vary from one TV model to the next. HDMI is another area where interoperability cannot always be assumed.

Cisco's Sports and Entertainment Solutions Group makes an effort to test the DMP with a variety of TV makes and models. However, there is a large variety of makes and models on the market. And each model is on the market for a relative short time, before it is replaced with a newer better and cheaper model. Due to the rapid refresh rate it is not practical for Cisco to test Cisco StadiumVision with every TV model on the market. Hence it is considered best practice to include TV qualification as a task in the planning phase of every Cisco StadiumVision project plan.

This testing should occur as early as possible in the project timeline, as the testing may uncover a need for special cabling and adaptors, or reveal issues with the TV or DMP firmware that needs to be addressed. Early identification allows the issue to be address before DMP and TV deployment starts.

This document outlines a test process that can be followed by the Cisco delivery team or partner doing the actual deployment. The process is designed so that it can be performed independently of the venue deployment schedule. The equipment used for testing is minimal and mobile, allowing the testing to be done at either the TV supplier or at the partner's office.

Test Bed Topology

[Figure 33](#) shows the topology of the qualification test bed.

Figure 33. TV Qualification test bed

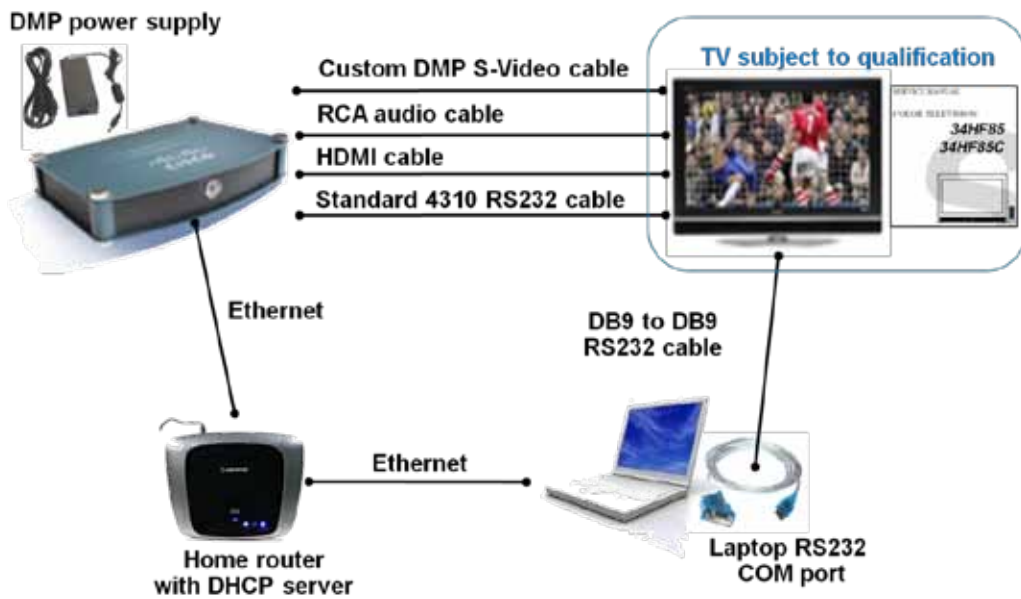

Bill of Materials for Test Bed

[Table 3](#) is a bill of materials for the equipment needed to build the test bed.

Table 3. Bill of Materials for Qualification Testbed

| Description | SKU | Qty |
|--|--------------------|-----|
| Laptop with RS-232 DB9 COM port | | 1 |
| Home router with DHCP server | | 1 |
| Ethernet cable | | 2 |
| DMP 4310 | DMP-4310G-52-K9 | 1 |
| HDMI cable | Included with 4310 | 1 |
| DVI to HDMI adaptor | | 1 |
| Multi-function 4310 S-Video cable | Custom | 1 |
| Power supply for DMP 4310 | DMP-4310-PWR | 1 |
| Cable for DMP 4310 power supply | CAB-AC-C5 | 1 |
| RCA audio cable | Included with 4310 | 1 |
| Standard RS-232 cable for DMP 4310 | Included with 4310 | 1 |
| Standard DB9 to DB9 RS-232 cable | | 1 |
| RS-232 null modem adaptor – DB9 to DB9 | | 1 |

Firmware Versions

Qualification starts by recording the firmware version of both DMP and the TVs being qualified. Changing TV or DMP firmware versions may change the qualification outcome, hence the results are only valid for the specific versions tested. Follow these steps to record the firmware versions:

1. Connect both DMP and laptop to the home router. Then confirm that they both receive an IP address from the DHCP server.
2. Browse to the IP address of the DMP. From the DMPDM navigate to the 'Hardware and Firmware Version' tab. Record the 'Firmware Release Version' and 'Build Date and Time' in table 2. If this is not the version that you plan to use in production then upgrade the DMP to that version.
3. Use the TV IR remote to access the settings menu. Find the firmware version and record it in table 2. Note that on some TV's the firmware version is only accessible via the service menu. If this is the case then consult with your TV vendor for how to access it.

Table 4. RS-232 control codes for the TV being qualified

| Device | Firmware version |
|------------|------------------|
| DMP 4310 | |
| TV model X | |
| TV model Y | |
| | |

Video and Audio

This section describes how to validate the integrity of video and audio delivered by the DMP to the TV.

1. Connect the DMP and TV via the desired video connection, i.e. HDMI, DVI, Component or S-Video. If HDMI not used then also connect the audio path using the RCA cable.
2. Copy a proven MPEG-TS video file with audio onto a USB flash key. Insert the flash key into one of the USB ports on the DMP.
3. Connect both DMP and laptop to the home router, and confirm that they both receive an IP address from the DHCP server.
4. Browse to the IP address of the DMP. From the DMPDM navigate to the 'Media Playback' tab. Set the Protocol dropdown to file:// and Video Loop to Yes.
5. Type the following into the Media URL field:
file:///tmp/ftproot/usb_2/test_file.mpg. Substitute [test_file.mpg](file:///tmp/ftproot/usb_2/test_file.mpg) for the name of the file you are using. Direct the DMP to play the video file by clicking the Start button.
6. Verify that the quality of the video being played on the screen is good. Correct any over-scan or under-scan issues by experimenting with the different aspect ratios available on the TV settings menu. If a non-default setting is needed then determine the corresponding RS-232 control code and add it to table 2. This allows it to be included in the display specification, and set centrally from Cisco StadiumVision Director upon startup.
7. Verify that the quality of the audio is acceptable. If audio is missing then double check the audio cabling.
8. Power the TV off by unplugging the power cord. Leave it off for a minute and then power it back on. Verify that the video is still playing with the expected quality.

9. Power the DMP of by pushing the power switch. Leave it off for a minute and then power it back on. Restart video play out from the DMPDM and verify that it plays out with the expected quality.
10. Subject both DMP and TV to burn in by letting the video play uninterrupted for 12 hours straight. Then repeat steps 8 and 9.

RS-232

This section describes how to validate the RS-232 cable and control codes.

1. Determine and record the RS-232 control codes for the TV under qualification. These can typically be found in the user manual for the TV in question. See "[Appendix B: Determining the RS-232 Command Strings](#)" for an example. Record the subset of codes needed by Cisco StadiumVision Director in [Table 5](#) below.
2. Connect the DB9 to DB9 RS-232 cable between laptop and TV. If the TV's RS-232 connector is the wrong gender then insert the DB9 null modem adaptor. If the TV's RS-232 connector is not DB9 then create a custom cable to match.
3. Use Hyperterm, Putty or some other terminal emulator SW to manually send the RS-232 'Power ON' control code to the TV. If the TV does not power on then trouble shoot the cable pin-out and reconfirm the RS-232 command code.
4. Validate that the TV's response to the RS-232 Power ON command matches what is recorded in [Table 5](#) for Power On Confirm.
5. Manually transmit the remaining RS-232 controls codes from [Table 5](#) and confirm that the TV reacts as expected.
6. Change the RS-232 cabling so the DMP connects to the TV instead of the laptop.
7. From the laptop browse to the IP address of the DMP. From the DMPDM navigate to the 'Serial Interface' tab and paste the RS-232 Power ON control code into the 'Hex String' field. Click 'Send Message' to transmit the command to the TV. If the TV does not power on as a result then the cable pin-out is possibly incorrect.
8. If qualification determines that a custom RS-232 cable is needed then have these ordered ASAP so they can be available when DMP deployment starts.

Table 5. RS-232 control codes for the TV being qualified

| TV Function | RS-232 string |
|--------------------------|---------------|
| On | |
| Off | |
| Lock front panel buttons | |
| Power Status Query | |
| Power On Confirm | |
| Disable over scan | |
| Mute | |
| Unmute | |
| Volume Up | |
| Volume Down | |
| Volume 1 | |
| Volume 2 | |
| Volume N | |
| Enable Tile Mode | |
| Disable Tile Mode | |
| Tile Position 1 | |
| Tile Position 2 | |
| Tile Position N | |
| Select Input 1 | |
| Select Input 2 | |

Network Readiness

Before you begin:

1. Provision the Cisco StadiumVision Director Server in its production location. See the hardware installation guide for your server model at: [Install and Upgrade Guides](#)

2. Install Cisco StadiumVision Director software on the StadiumVision Director Server. See the [Cisco StadiumVision Director Software Installation and Upgrade Guide](#).
3. Configure a DHCP server for your network so that the DMP can obtain an IP address. For an IOS-embedded DHCP Server, see below for an sample configuration:

```
ip dhcp pool dmp
  network 10.50.1.0 255.255.255.0
  default-router 10.50.1.1
```

As an alternative, you can use the Cisco Network Registrar (CNR). CNR provides a feature-rich DHCP and DNS server that can be used in the Cisco StadiumVision network. For more information about using CNR with StadiumVision, see the *Cisco Network Registrar Best Practices Guide for StadiumVision*.

Chapter 3 DMP Deployment

This section describes how to deploy Cisco 4310G Digital Media Players (DMPs) using Cisco StadiumVision Director Release 2.4. The workflow described includes the auto-registration and provisioning of the DMP and how to map the DMP to a physical Location Name within StadiumVision Director. This workflow gets the DMP to the state where it is configured and running the correct firmware version, and ready to be assigned to its appropriate Groups.

This section assumes that you are familiar with the Cisco StadiumVision Director Management Dashboard and Control Panel. For further information on these parts of the solution please refer to the Related Documents section at the beginning of this guide.

Installation Prerequisite Steps

1. Enable Auto-Registration and Provisioning in Cisco StadiumVision Director.
2. Configure the switch ports for DMP.
3. Configure a DHCP Server for DMP Auto Registration.
4. Set the Default Video Channel in Cisco StadiumVision Director.
5. Configure RS-232 Codes for TV Control.
6. Load the TV/DMP Locations into Cisco StadiumVision Director.
7. Assign each Location to its desired Groups.

Installation Steps and Flow

1. The installer mounts the TV and DMP in the desired spot.
2. The installer then connects the required power, video, audio, network and control cabling.
3. The DMP powers up and gets network information via DHCP, including the Cisco StadiumVision Director registration URL.
4. Next the DMP auto-registers with Cisco StadiumVision Director using registration URL. As a result the DMP appears in the database in state 'Not-Ready'.
5. Cisco StadiumVision Director then proceeds to provision the DMP and upgrade the firmware. Once complete the DMP state changes to 'Ready'.
6. Before leaving the area the installer records the Location and corresponding DMP MAC address.
7. The DMP MAC address and Location pairs are handed off to a data entry person, who uses it to map each DMP to its target Location.

DMP Auto Registration and Provisioning

ONLY the Administrator role for Cisco StadiumVision Director can perform the procedures in this guide.

In Cisco StadiumVision Director Release 2.3 and later, a DMP 4310G can auto-discover the Cisco StadiumVision Director server via DHCP and then auto register with Cisco StadiumVision Director. Once a DMP is registered, Cisco StadiumVision Director automatically executes the necessary commands to provision the DMP for operation with StadiumVision.

This section describes the DMP auto-registration and auto-provisioning workflows for preparing Cisco StadiumVision Director, the DHCP Server, and the DMP to use the auto-registration and auto-provisioning functionality. It also covers how to view the workflow status throughout the auto-registration process.

Note: Auto registration is not supported for the DMP 4305G.

Note: DMP 4310s must have firmware SE2.2.1 build 1932 or later installed in order to support auto-registration.

Understanding DMP Auto-Registration

[Figure 34](#) illustrates the auto-registration process. Although the diagram shows the Cisco IOS DHCP Server, you can use any DHCP server that supports the configuration of DHCP Options, for example a CNR (Cisco Network Registrar server) DHCP server. This document will describe how to set up both Cisco DHCP Servers for DHCP options.

Figure 34. Auto Registration Process

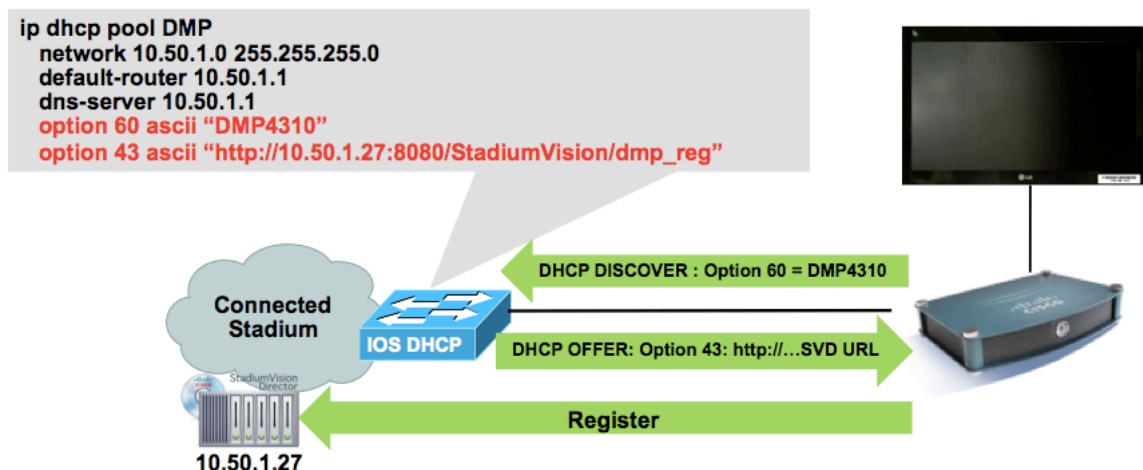

Auto Registration Workflow

1. Upon boot up, the DMP sends a DHCP DISCOVER message including the Option 60 information to identify itself as a DMP 4310 to the DHCP Server.
2. The DHCP server recognizes the identifier and sends back an OFFER including Option 43 information. This information is the URL that tells the DMP where to register. The URL used for registering is as follows: `http://<SV Director IP Address>:8080/StadiumVision/dmp_reg`.
3. The DMP uses the registration URL to register with Cisco StadiumVision Director.
4. Upon registration Cisco StadiumVision Director creates a DMP in the database. The DMP is assigned the name `AUTO-xx-xx-xx-xx-xx-xx`, where `xx-xx-xx-xx-xx-xx` is the MAC address of the DMP. [Figure 35](#) and [Figure 36](#) show DMPs that have successfully registered with Cisco StadiumVision Director. They are still in the “Not Ready” state as they have not yet been provisioned.

Figure 35. Auto Registered DMPs in the Dashboard

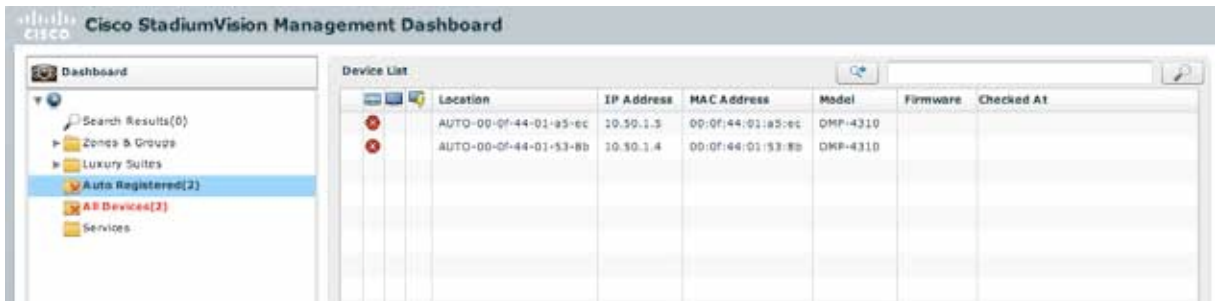

The screenshot shows the Cisco StadiumVision Management Dashboard. On the left is a navigation menu with 'Auto Registered(2)' selected. The main area displays a 'Device List' table with two entries:

| Location | IP Address | MAC Address | Model | Firmware | Checked At |
|------------------------|------------|-------------------|----------|----------|------------|
| AUTO-00-0f-44-01-a5-ec | 10.50.1.3 | 00:0f:44:01:a5:ec | DMP-4310 | | |
| AUTO-00-0f-44-01-53-8b | 10.50.1.4 | 00:0f:44:01:53:8b | DMP-4310 | | |

Figure 36. Auto Registered DMPs in the Control Panel



The screenshot shows the Cisco StadiumVision Control Panel. The 'Devices' tab is active, and the 'Locations & DMPs' sub-tab is selected. A table displays the following data:

| Type | Name | IP Address | MAC Address | Description | State |
|------|------------------------|------------|-------------------|-------------|-----------|
| DMP | AUTO-00-0f-44-01-53-8b | 10.50.1.4 | 00:0f:44:01:53:8b | | Not Ready |
| DMP | AUTO-00-0f-44-01-a5-ec | 10.50.1.3 | 00:0f:44:01:a5:ec | | Not Ready |

Understanding DMP Provisioning

The DMPs require specific configuration and firmware to be provisioned from Cisco StadiumVision Director before they can be placed into production. This section describes that workflow.

Provisioning Workflow

Once a DMP is auto registered, Cisco StadiumVision Director may be configured to perform the provisioning automatically or the operator may choose to perform it manually using the Cisco StadiumVision Director Management Dashboard. The DMP provisioning workflow is as follows:

1. Cisco StadiumVision Director polls the DMP for specific MIB values.
2. The DMP will return the requested MIB variable settings to Cisco StadiumVision Director for evaluation.
3. Upon determining the DMP's compliance, Cisco StadiumVision Director will execute the required commands as needed to provision the DMP and place it into the "Ready" state.
4. After provisioning is complete, the DMP displays on the TV an installation flash graphic along with the default video channel. This flash graphic shows the state of completion of the DMP provisioning, DMP IP and MAC addresses, default gateway, firmware version, and other pertinent information.

Note: Cisco StadiumVision Director only sends the provisioning commands to the DMP if the DMP has not yet been provisioned in Cisco StadiumVision Director. StadiumVision Director performs a check before executing each command.

Figure 37. 5 Step Provisioning Process

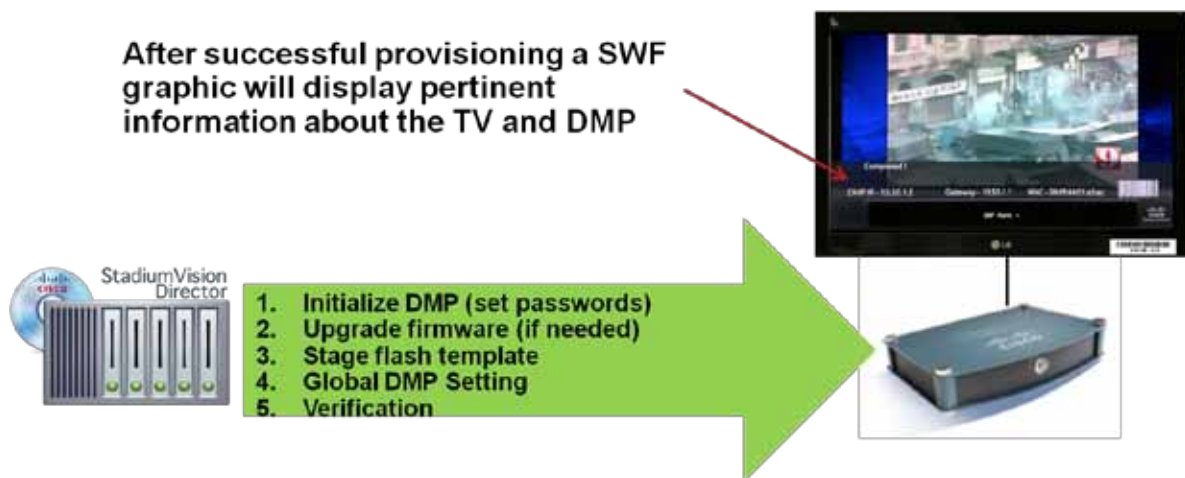

Provisioning Functional Description

The DMP provisioning is performed by the **Provision DMP** operation in the Cisco StadiumVision Director Management Dashboard. The **Provision DMP** operation is a collection of Dashboard commands with additional specifications related to timeouts and retries. This command is similar to a macro that is typically created to execute a set of operations in sequence with dependency checking. That is, the commands will be executed only if the previous command was successful.

The **Provision DMP** operation can be initiated automatically or manually. Each time the **Provision DMP** is initiated, one of the following actions occur:

- Create a new instance of the **Provision DMP** operation and execute from Step 1 in the provisioning flow for each of the selected devices, OR
- Advance an already executing **Provision DMP** operation to the next step for each of the selected devices, if applicable.

Either of the above two operations will occur regardless of whether the **Provision DMP** was manually or automatically initiated. Operation instances are created and tracked on the Cisco StadiumVision Director Server.

[Table 6](#) lists the commands that are part of the **Provision DMP** operation and the sequence in which they are executed. If any step fails, the overall **Provision DMP** operation fails.

Table 6. Provision DMP Provisioning Commands

| Main Task | Sub tasks | Description |
|----------------------|-----------------|---|
| Initialize DMP | GetStatus | Retrieve the current settings on the DMP |
| | StateTransition | Change the DMP State to 'Not Ready' |
| | InitialConfig | Executes the <i>InitialConfig</i> command on the DMP. This command sets the credentials in the DMP and is executed only if the DMP is in the <i>Factory Default</i> state. The DMP is rebooted as part of this command execution. The reboot causes the DMP to issue a subsequent DMP registration message, which in turn triggers the Workflow to advance to the next step. |
| | GetStatus | The <i>GetStatus</i> command retrieves the most current configuration on the DMP. The <i>GetStatus</i> command is executed at various points of the <i>Provision DMP</i> workflow and is intended to refresh the DMP state in Cisco StadiumVision Director so that the execution of previous Workflow steps are reflected correctly in the Cisco StadiumVision Director Database. |
| Upgrade DMP firmware | FirmwareUpgrade | The Cisco StadiumVision Director will upgrade the Firmware on the DMP, based on the value configured in StadiumVision Director. A subsequent DMP reboot then triggers the Workflow to advance to the next step |
| Stage Flash Template | StageTemplate | The Flash Template is staged on the DMP. |
| Global DMP Settings | GlobalMIB | Deploy the <i>Global DMP Settings</i> configured in Cisco StadiumVision Director on the DMP. This step is performed only if the device is not conforming with the current <i>Global DMP Settings</i> |
| | GetStatus | Retrieves the most current configuration on the device. Note that a previously executed <i>FirmwareUpgrade</i> would have changed the version and build strings on the DMP to now match what is configured on Cisco StadiumVision Director |
| | SetAppOn | Turns on the application that displays auto-registration status info on the TV |
| | SetAppUpdate | Updates the status info displayed on the TV |
| | SetAppUpdate | Another update to the status info displayed on the TV |

| | | |
|--------------|-----------------|---|
| | StateTransition | Sets the DMP State to 'Ready' |
| | SetAppUpdate | Yet another update to the status info displayed on the TV |
| Verification | GetStatus | This final GetStatus is issued to get the most current DMP configuration. It is not necessary to issue this final GetStatus. However, this command has been placed in the <i>Provision DMP</i> workflow to work around certain timing issues that may arise when retrieving the Flash Template status |
| | SetAppUpdate | Update the status info displayed on the TV to show 'Completed!' |

Note: You can see more detail about the steps and sub steps being performed by viewing the status messages on the **Console** tab at the bottom of the screen in the Management Dashboard. Do not be alarmed if you see a sub step being repeated. This is normal as the process is iterative. For example, once a DMP has been upgraded the FirmwareUpgrade step will be repeated in order to confirm that the DMP is now running the expected firmware version.

Automatically Executing the Provision DMP Command

The **Provision DMP** operation is automatically initiated if both the Enable Auto Provisioning and Enable Auto Registration keys are set to true in the Dashboard, and if StadiumVision Director is configured to indicate DHCP is in use under SV_Director_Config → System_Config → Global_DMP_Settings → Common → DHCP".

The **Provision DMP** will be skipped if the DMP is in the "Ready" or "In Production" state. Whenever a registration message is received from the DMP, a new instance of this workflow command is created or a previously running instance is advanced. The DMP sends a registration request to the Cisco StadiumVision Director every time it is rebooted, assuming that DHCP is enabled and the DHCP Server is appropriately configured. Several of the commands in the Provision DMP workflow require the DMP to be rebooted. Such commands will automatically reboot the DMP as needed.

Preparing Cisco StadiumVision Director and the DHCP Server for auto-registration and provisioning will be described in a later section.

Auto-Registering and Auto-Provisioning Multiple DMPs

There is no hard limit as to how many auto-registrations StadiumVision Director can handle at the same time. However, as registrations come in, a maximum of 50 auto-registered DMPs can be provisioned in parallel. The remaining DMPs are queued for provisioning and as DMPs complete the provisioning process, new DMPs are provisioned.

Note that the limit of 50 is the maximum number of DMPs that StadiumVision will send commands at any given point in time. However, more than 50 DMPs may end up being provisioned simultaneously since different DMPs may be in different states. For example, DMPs that are in the middle of a reboot are skipped until these

DMPs complete the reboot sequence and notify the Dashboard via the registration request.

DMP States During Provisioning

While a DMP is being provisioned, it transitions through three states:

Not Ready -> Ready -> Production

- **Not Ready:** The DMP is registered in Cisco StadiumVision Director but has not been provisioned.
- **Ready:** The DMP is provisioned in Cisco StadiumVision Director but has not been assigned to a Location. Note that all scripting is done on Locations and not on DMPs.
- **In Production:** The DMP is registered, provisioned and assigned to a Location in Cisco StadiumVision Director.

As the DMP transitions through these states, you can view the progress on the Management Dashboard and Control Panel. See [Viewing the Workflow Status in the Dashboard](#).

Manually Executing the Provision DMP Command

As an alternative to using auto-provisioning, you can manually execute the **Provision DMP** operation to provision one or more DMPs. This operation is executed from the Dashboard just like any of the other Dashboard commands.

The **Provision DMP** command performs 3 different operations, depending on the parameter with which it is invoked:

1. Execute Provision DMP command
Select Provision DMP command. Select "Execute" in the operation drop down in the command arguments panel (default). Then select DMPs and press Play.
2. Cancel Provision DMP command
Select Provision DMP command. Select "Cancel" in the operation drop down in the command arguments panel. Then select DMPs and press Play.
3. View status of Provision DMP command
Select Provision DMP command. Select "Query" in the operation drop down in the command arguments panel. Select DMPs. Press Play. The status is displayed in the Console tab of the DMP. Select a DMP and view the status of the Provision DMP command in the console tab.

Figure 38 illustrates the Provision DMP in the Dashboard Device Configuration drawer.

Figure 38. Manually Executing the Provision DMP Command

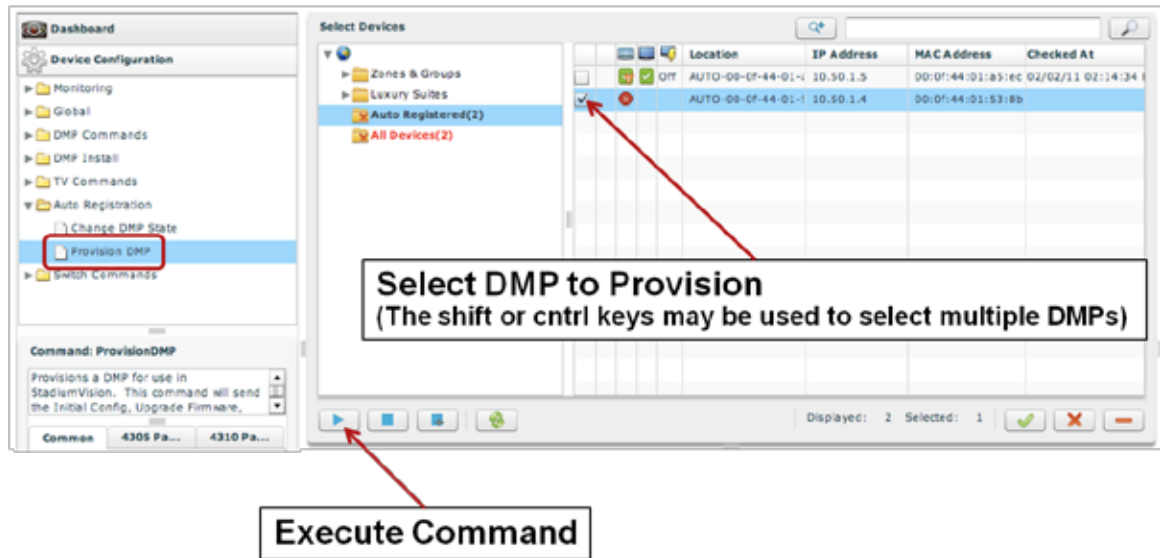
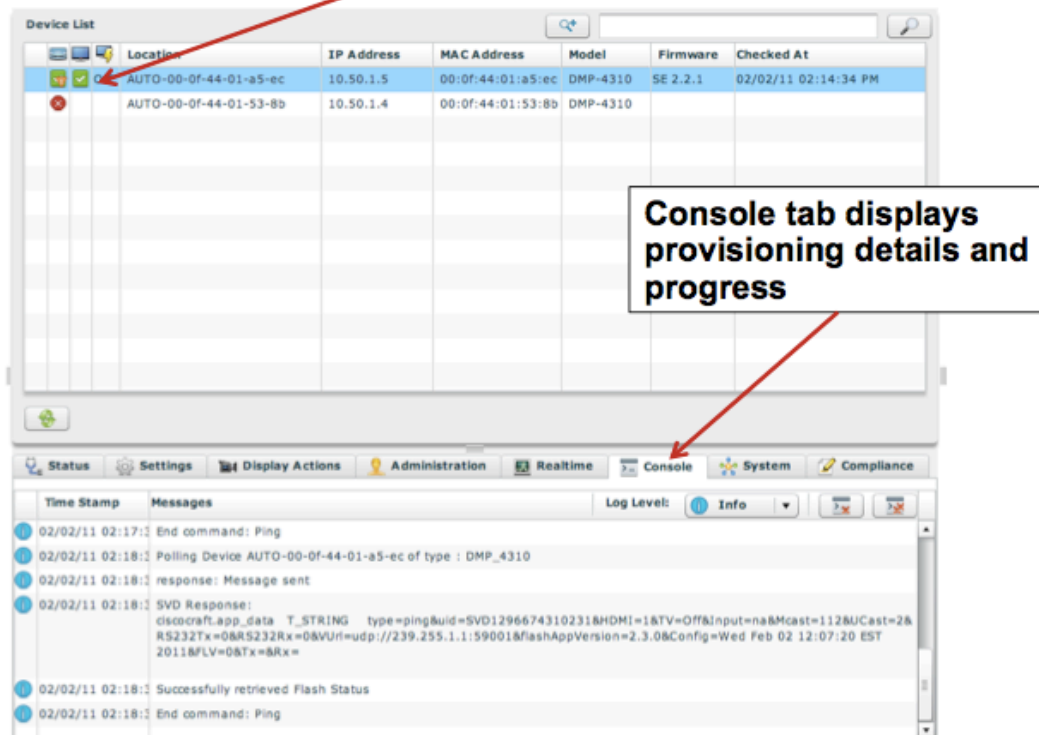

Figure 39. Provisioned DMPs in the Dashboard

The green checks indicate the DMP and TV are in "Ready" State



Note: To see the detailed DMP Status, click the Status tab.

Figure 40. Provisioned DMPs in the Control Panel



| Type | Name | IP Address | MAC Address | Description | State |
|------|------------------------|------------|-------------------|-------------|-----------|
| DMP | AUTO-00-0f-44-01-53-8b | 10.50.1.4 | 00:0f:44:01:53:8b | | Not Ready |
| DMP | AUTO-00-0f-44-01-a5-ec | 10.50.1.5 | 00:0f:44:01:a5:ec | | Ready |

After a successful provisioning of the DMP, SV Director moves the DMP into the “Ready” State

Preparing CISCO STADIUMVISION DIRECTOR, DHCP Server & DMP for Auto Registration

Perform the following steps to prepare Cisco StadiumVision Director, the DHCP Server and the DMP for auto-registration and auto-provisioning.

1. Enable auto-registration and auto-provisioning in the Cisco StadiumVision Director Management Dashboard. See the [Enabling Auto Registration and Auto Provisioning in the Dashboard](#) section.
2. For auto-registration to work DHCP for the DMPs must be set to “on” under Cisco StadiumVision Director Configuration. By default DHCP is enabled on a new 2.4 install, but double check to make sure it has not been changed.
3. Setup the DHCP Server with options that enable the DMP to discover and register with Cisco StadiumVision Director. See the [Configuring DHCP Options](#) section.
4. Verify that the DMPs being deployed are auto-registration capable. This requires that they are running SE2.2.1 build 1932 or later, or DMS 5.2.2 or later. At the time of writing both these versions have been available for at least 6 months and it can be assumed that all units shipped from factory are imaged with auto-registration capable firmware. Units that have been sitting on the shelf at a distributor for an extended period of time may arrive with an older version that does not support auto-registration.

Enabling Auto Registration and Auto-Provisioning

By default, the auto-registration and auto-provisioning settings in Cisco StadiumVision Director are disabled. To use these features, you need to enable them in the Management Dashboard as follows.

1. Open the Management Dashboard and select **Director Configuration > Auto Registration Settings**.
2. In the Cisco StadiumVision Director Configuration Property panel, set the values to 'true' for Enable Auto Registration and Enable Auto Provisioning. Refer to [Figure 41](#).
3. Click the save button. 

Figure 41. Enabling Auto Registration and Auto Provisioning in the Dashboard



Configuring the DMP Firmware Version

As part of auto-registration Cisco StadiumVision Director will upgrade a DMP that is not already running the desired version. The desired version must be explicitly configured by setting `init.version` and `init.build` in the same window where auto-registration/provisioning was enabled in the previous section. Both `init.version` and `init.build` have default settings. These may or may not match the desired version for a given deployment, so they should be checked before DMP deployment starts so they can be modified if needed.

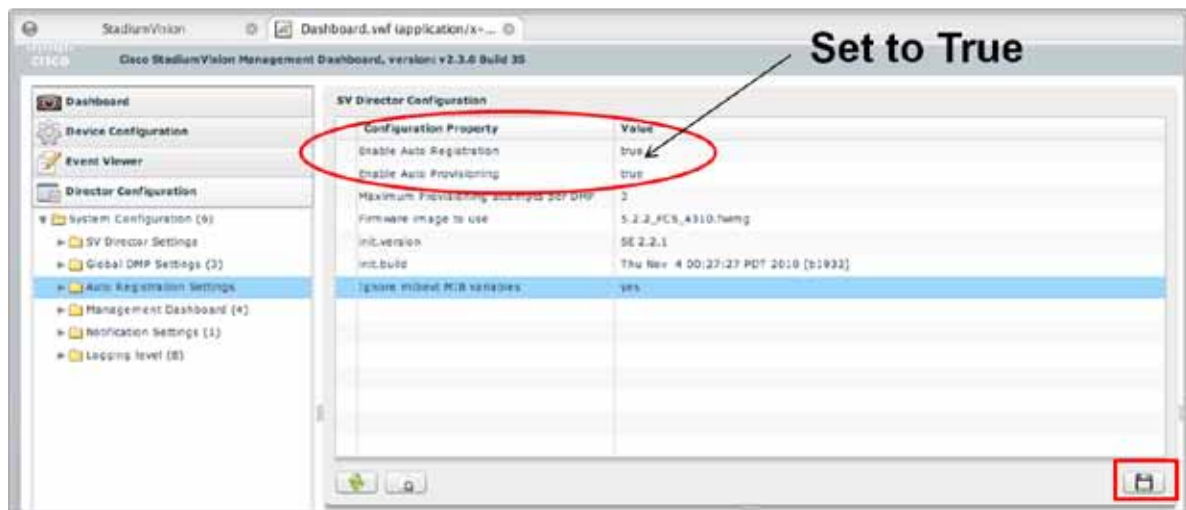
The latest DMP 4310 firmware can be downloaded from SW-Center on www.cisco.com. In order to deploy it to DMPs the firmware must first be uploaded to CISCO STADIUMVISION DIRECTOR using the DMP_and_TV_Controls → DMP_Install → Firmware → Upgrade option.

Configuring the Default Video Channel

To verify video is working properly after a successful provisioning operation, set the default Video Channel in the Management Dashboard.

Figure 42. Configuring the Default Video Channel



If the default video channel is not configured properly, or if no video channel is available, then the provisioning screen displayed on the attached display will not show any video. This is not a problem in itself, but it does mean that proper multicast operation to the DMPs cannot be verified as part of the install.

Configuring DHCP Options

The DMP auto discovers the Cisco StadiumVision Director server via DHCP and then auto registers with Cisco StadiumVision Director. This discovery process uses Option 60 and Option 43 where Option 60 is used to identify the DMP as the requesting device of Option 43 information. Option 43 is configured with the URL that the DMP will use for registration with Cisco StadiumVision Director.

Cisco IOS DHCP Server

To configure the Cisco IOS DHCP Server for Option 60 and Option 43:

1. Access the configuration mode at the Cisco IOS CLI.
2. Configure the ip helper-address on the Video VLAN to point the DHCP server to where this configuration will be done. If the DHCP server is configured on the local switch where the DMPs are connected, this step is not required.

```
interface Vlan200
  ip address 10.50.1.1 255.255.255.0
  ip helper-address 10.131.130.13 (Router with DHCP Server Configured)
  ip pim sparse-mode
```

3. Create the DHCP pool, which includes the necessary parameters, such as default router and server name. This is an example DHCP scope:

```
ip dhcp pool <pool name>
```

```
network <ip network> <netmask>  
default-router <default-router IP address>
```

4. Add the Option 60 line with this syntax:

```
option 60 ascii DMP4310
```

5. Add the Option 43 line with this syntax:

```
option 43 ascii http://<SV Director IP Address>:8080/StadiumVision/dmp_reg
```

For example, to configure Option 43 for Cisco DMP 4310 with the Cisco StadiumVision Director IP address 10.50.1.27, add this line to the DHCP pool in the Cisco IOS CLI:

```
option 43 ascii http://10.50.1.27:8080/StadiumVision/dmp_reg
```

Note: The Cisco IOS DHCP server is limited to one Option 43 for each DHCP pool, so you can only configure a DHCP scope for a single device type. This should not pose a problem since the recommendation is to use separate VLANs per service. For example, Video VLAN for DMPs, Voice VLAN for IP phones, and Wireless VLAN for APs.

IOS documentation calls for the URL to be enclosed in double quotes (“”). In the case of SV this is not required as there are no spaces in the URL. Furthermore, a bug in certain versions of IOS causes the quotes to be treated as if they are part of the URL. Hence it is recommended to not use quotes.

Configuring CNR for Option 43

1. Enter configuration mode at the Cisco IOS CLI.
2. Configure ip help-address on the Video VLAN to point the CNR DHCP server where this configuration will be done. If the DHCP server is configured on the same VLAN where the DMPs are connected then this step is not required.

```
Interface Vlan200
  ip address 10.50.1.1 255.255.255.0
  ip helper-address 10.129.130.13 (CNR Server)
  ip pim sparse-mode
```

3. In CNR web interface, select the **Advanced** mode then select **DHCPv4 > Options**.
4. Click the **Add Option Definition Set** button



Add DHCP Option Definition Set

| Attribute | Value |
|-----------------------------|---------------------------------|
| Name* | SVautoreg |
| DHCP Type* | DHCPv4 |
| Description | StadiumVision Auto-Registration |
| Vendor Option String | DMP4310 |
| Vendor Option Enterprise Id | |

5. Create an Option definition by giving it a Name (e.g., SVautoreg) and choose DHCP Type DHCPv4. The Description is optional but you will have to specify a Vendor Option String. Use "DMP4310" as the string. This string is what is sent to the DHCP server when the DMP sends its DHCP Discover message requesting network setting information (e.g., IP Address, Gateway, etc.)
6. Click the DHCP Option Definition Set you created and then Add DHCP Option. Set the number to 43 and give it a name (e.g., sv_autoreg). Define this option to use a string as its value.

Advanced Administration Servers Clusters Routers DHCP v4 DHCP v6
 Scopes Scope Templates Reservations Networks Options Policies Clients Client-Classes VMs Failover DNS LDM

List DHCP Option Definition Sets

DHCPv4 Option Definition Sets

| Name | Description |
|---------------------------------------|-------------------------|
| SVautoreg | |
| dhcp-cablelabs-config | CableLabs v4 DOCSIS 3.0 |
| dhcp-cisco-config | Cisco Systems, Inc. |
| dhcp-config | |

DHCPv6 Option Definition Sets

| Name | Description |
|--|-------------------------|
| dhcp6-cablelabs-config | CableLabs v6 DOCSIS 3.0 |
| dhcp6-cisco-config | Cisco Systems, Inc. |
| dhcp6-config | |

Add DHCP Option Definition

| Attribute | Value |
|-------------|---|
| Number* | <input type="text" value="43"/> |
| Name* | <input type="text" value="sv_autoreg"/> |
| Description | <input type="text"/> |
| type* | <input type="text" value="string"/> |
| repeat | <input type="text" value="[0]"/> |

- Be sure to click, Modify Option Definition Set to save the option 43 settings.

List DHCP Option Definitions

List of Option Definitions for *SVautoreg*

| Number | Name |
|--------------------|----------------------------|
| 43 | sv_autoreg |

- Now, add this option to the default policy by going to **DHCPv4 > Policies** and click default. Go to the DHCPv4 Options drop-down menu and choose the Option (e.g., SVautoreg). Select the option 43, (e.g., sv_autoreg) to set the string. This string should be the following:
 http://<sv_director_IP>:8080/StadiumVision/dmp_reg

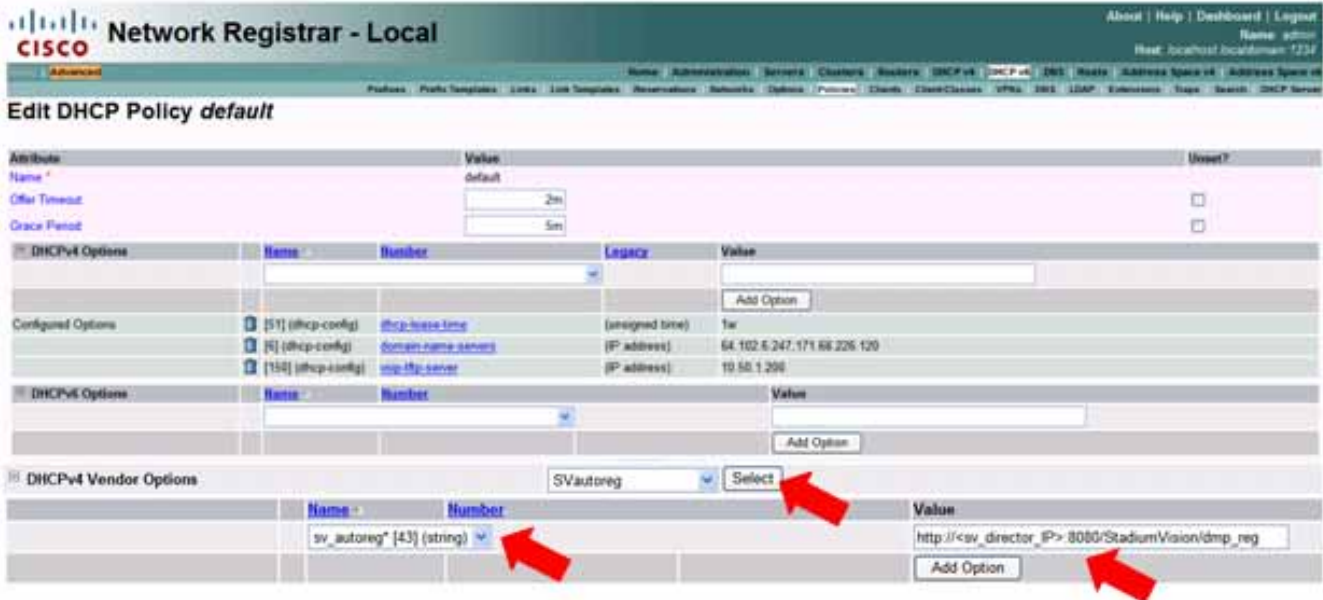

9. Click Modify Policy at the bottom of the page to save the configuration.
10. Once this configuration is completed and saved, click on the DHCP Server and click the restart icon to restart the DHCP Server.



Configuring Display Specifications for TVs

The Cisco StadiumVision Director Control Panel requires that you configure certain commands for the TVs used in the venue. These commands are used in the communications between the DMP and the TV. It is critical that this information is accurate as it will impact the StadiumVision TVs in ways that may not be obvious at first pass.

When you define Locations in StadiumVision Director (later in this process), you will select the “Display Spec” for the type of TV (brand/model) that is physically installed at the defined Location. Therefore, it is recommended that you configure display specifications for all TV types in the venue *prior* to adding the Locations to StadiumVision Director.

You will need to define a different Display Spec for each *unique* TV type based on how images are centered and stretched, and which serial commands are used to control the TVs. In some cases, all TVs from a certain manufacturer can use the same display specs. In other cases different TV models from the same company may have different display specs.

There are two categories of Display Specs for each type of TV: Basic Info and Serial Commands. Display specifications for several common TV types are included with CISCO STADIUMVISION DIRECTOR when installed. If the TV that you are installing is not listed then refer to the manufacturer's documentation to obtain the necessary codes. The TV qualification section describes this in further detail. Once the codes have been obtained add a new display spec for the TV as follows:

1. Access StadiumVision Director by opening a browser window and entering the following:

https://SV_Director_IP_addr:8080/

where *SV_Director_IP_addr* is the IP Address for the StadiumVision Director.

The StadiumVision Director main screen displays, as shown in [Figure 43](#).

Figure 43. Cisco StadiumVision Director Main Screen



2. Click **Control Panel**.
3. Select **Setup > Devices**.
4. Click on the **Display Specifications** tab.
5. Click the “+” at the upper right of the Display Spec list box.

Configuring Display Specifications: Basic Info

On the Basic Info tab, specify the following information:

Figure 44. Basic Info Screen

The screenshot shows a web interface with tabs: Locations & DMPs, Location-DMP Mapping, IP Phones, Local Control, and Display Specifications. The 'Display Specifications' tab is active. On the left, a 'Display Spec List' contains items like Panasonic-Viera, NEC, Jays Shop, LG (highlighted), Panasonic 32, Sony, 32 inch Displays, Sharp Aquos, Panasonic-Viera, and IRBlaster. On the right, the 'Basic Info' sub-tab is selected, showing fields for Device Name* (LG), Description (LG), Make* (LG), Model* (LG), X Position (0), Y Position (0), X Scaling (0), Y Scaling (0), and Volume Strategy (External). A red arrow points to the 'External' dropdown menu, with a callout box containing the text: 'Click to Set Volume Strategy (Typically set to External)'. At the bottom left, there is a copyright notice: '© 2006 Cisco Systems, Inc. All rights reserved. Cisco Confidential'.

- **Device Name:** This is the name that will appear in the Display Spec drop-down list when you are adding TV Types to Locations in StadiumVision Director). This name should be unique and descriptive so you can easily identify the type of TV to which this applies.
- **Make:** The TV make or brand name.
- **Model:** The TV Model to which this Display Specification applies. You can enter a unique model type, a group of models, or All to indicate that all TVs of this brand have the same Display Specifications.
- **X and Y** coordinates for positioning and scaling (Optional). You should change these settings *only* if required for older TVs where graphics need to be fitted within the visible area.

These parameters default to (0, 0) for position and (0, 0) for scaling. The combination of these parameters allows you to position the Flash template application and stretch or shrink it anywhere on the screen to fit on the TV screen.

- **Position Parameters:** The X Position and Y Position parameters represent the starting point of the image. If they are not set correctly, the images will appear off-center. The X Position refers to the horizontal placement and the Y Position refers to the vertical placement. 0, 0 is the upper left hand corner, and that is the setting for most TVs. (All numbers are positive numbers, so the Y values represent the distance from Y=0 or the top of the screen).
- **Scaling Parameters:** The X Scaling and Y Scaling parameters set a scaling factor that can be used to shrink or stretch the Flash template application on the TV screen. A scaling factor of 1.0 (and zero) is equivalent to 100% of the original size, where X Scaling represents the width and Y Scaling represents the height. A scaling factor of 0.5 will shrink the Flash template application down to 50% (or half) of its original size. For most TVs, both scaling factors will be 1. The scaling factors are required for older TVs that do not have settings to control over scan on the TV. By default, some of these TVs suffer

from over scan, which causes some of the content to be clipped. This may not be noticeable when displaying a full-screen video channel, but it is very noticeable when displaying graphics (for example, a 3-Region template).

If you are uncertain of the correct values for your TV type, check the TV manufacturer's documentation for the correct values. If the information is not available, start with the defaults and adjust the parameters as required until the image fits the screen properly. This will need to be done only once per TV model.

- **Volume Strategy:**

- **External:** The volume on the TV is controlled by sending serial commands from the DMP to the TV (via RS-232). Note: The configuration of the External Volume strategy is recommended because TVs typically have better audio range than the DMP and many TVs provide a visual indicator of the volume level as the volume is being changed.
- **Internal:** The volume on the TV is controlled by changing the volume of the audio feed as it is transmitted from the DMP. This volume strategy would typically be used if the TV does not have RS-232 control and volume is to be controlled by Cisco StadiumVision Director remotely, the DMP IR remote, IP Phone or Crestron/AMX controller.
- **None:** The volume cannot be adjusted. This is useful for TVs that are used for video only where audio (if any) is provided separately (such as in a bar where an overhead system provides the audio).

6. Click **Save**.

Configuring Display Specifications

A Cisco StadiumVision Director Display Specifications is a container that holds attributes that are unique to a specific TV make and model. Attributes include things like RS-232 commands, RS-232 responses, timing values, input labels, etc.

RS-232 commands are used to control TV functions like on, off, mute, volume and external input. In more specialized scenarios they may also be used to configure TV tile matrix capabilities. All RS-232 commands configured in Cisco StadiumVision Director must be prefixed with **RS-232.tx_hex=**.

RS-232 responses are used to retrieve the current status of a TV. Currently Cisco StadiumVision Director uses responses only when querying a TV for its current power on/off status. RS-232 responses in Cisco StadiumVision Director are configured without a prefix.

For situations where a TV cannot be controlled via RS-232 or otherwise, volume and mute can be controlled by the DMP instead. This behavior is indicated by configuring volume and mute commands that start with **sigma=**.

To configure RS-232 serial commands:

1. Open the **Serial Commands** tab:

Figure 45. Serial Commands Screen

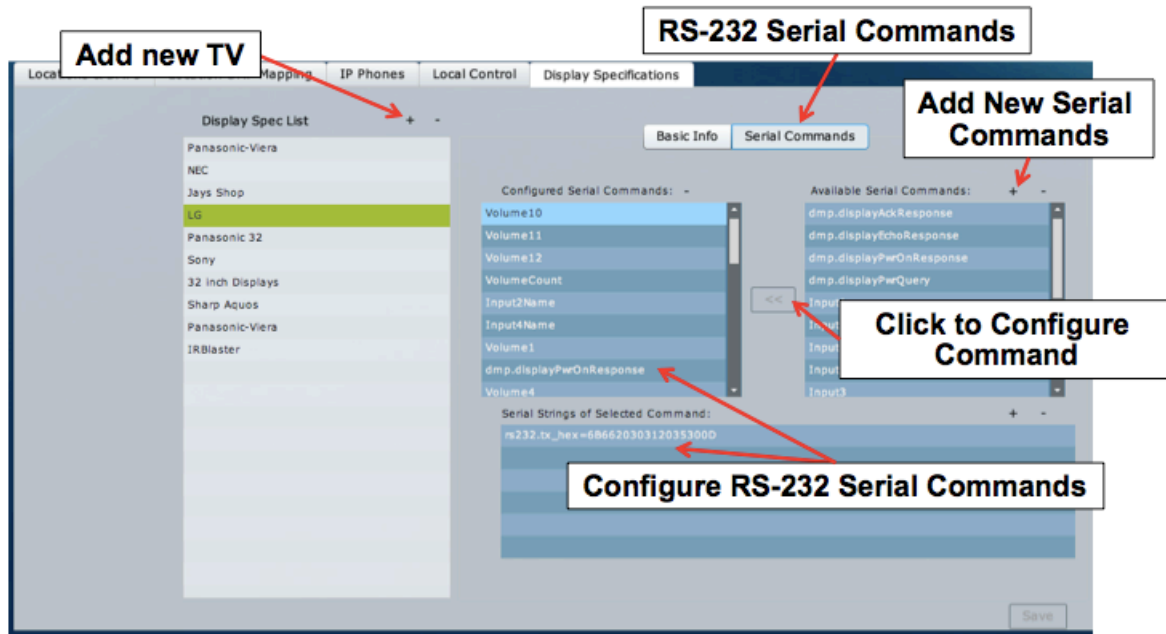

2. From the Available Serial Commands list, select the command or commands that you wish to add and click <<. This adds the command name to the list of Configured Serial Commands.
3. If the command you wish to configure is not in the list of Available Serial Commands, click the + at the upper right of the list box and enter the label you wish to use for the new command. Then click << to add the command to the list of Configured Serial Commands.
4. Highlight the serial command in the Configured Serial Commands list.
5. Click the + above the Serial Strings of Selected Commands list.
6. Enter the appropriate serial string. This string will now be associated with the highlighted serial command for this device.

Defining External Volume Commands

When using external volume control you must configure RS-232 commands to send to the TV when changing volume. Volume commands do not need to be configured when internal volume control is used.

StadiumVision Director allows you to define volume controls that are relative (volume up and volume down) or absolute (volume *number*). Relative volume commands depend on the volume increments set in the TV, which may vary widely from model to model. Therefore, the preferred method is to use absolute volume controls.

Absolute Volume Commands

To define absolute volume controls for the attached TV, you must first define the desired number of increments (levels) between minimum and maximum volume. If you do not define this then the system default of 10 levels will be used. Once completed proceed to define the RS-232 command for each volume level.

1. On the Serial Commands tab for the desired TV type, click the + at the upper right of the Available Serial Commands list box.
2. Enter "VolumeCount" as the command name, press return to add the new command.
3. The new command will be highlighted. Click << to move the command to the Configured Serial Commands list box.
4. With VolumeCount highlighted in the Configured Serial Commands list, click the + at the top of the Serial Strings of Selected Commands box.
5. Specify the number of increments (levels) to be used in controlling volume.
6. Press Enter on your keyboard.

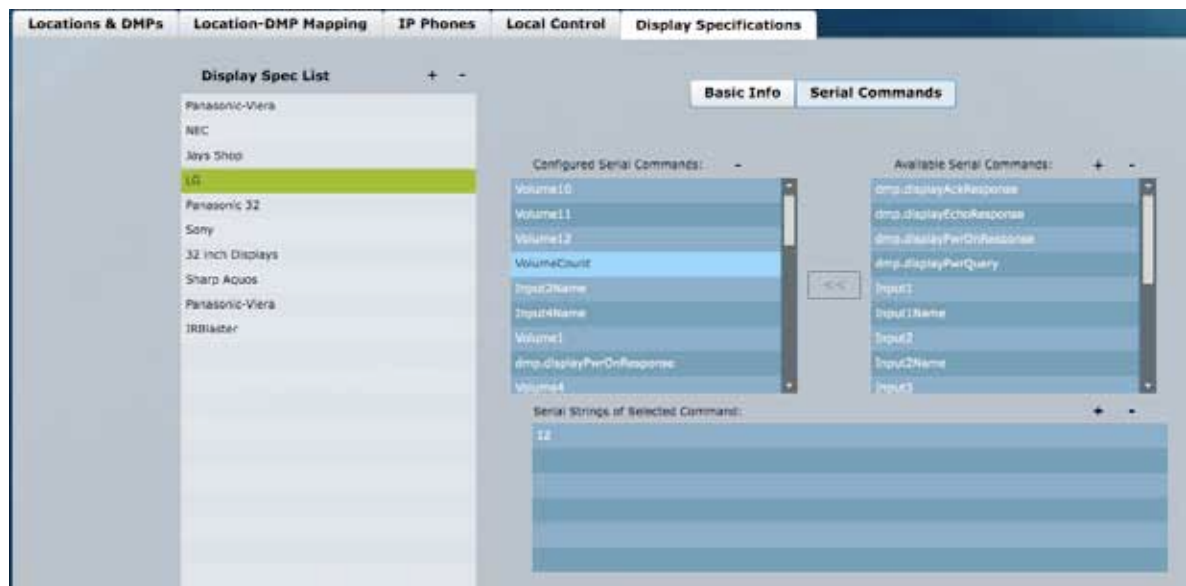

7. For each volume increment in the VolumeCount (1 through n):
 - a. Click + at the upper right of the Available Serial Commands box and add a corresponding command called Volumex, where x is a number (1 through n) that identifies the input. Do not prefix a leading, i.e. the first level should be Volume1 and not Volume01.
 - b. Select the Volumex command in the available list and click << to add it to the configured list.
 - c. Select the Volumex command in the configured list and click + at the upper right of the Serial Strings of Selected Commands. Enter the appropriate RS-232 command for that level of volume. For example, you might configure

"Volume1" with the RS-232 command that sets the TV Volume to the 5% volume level.

- Click **Save**. This string will now be associated with the configured serial command for the selected device.

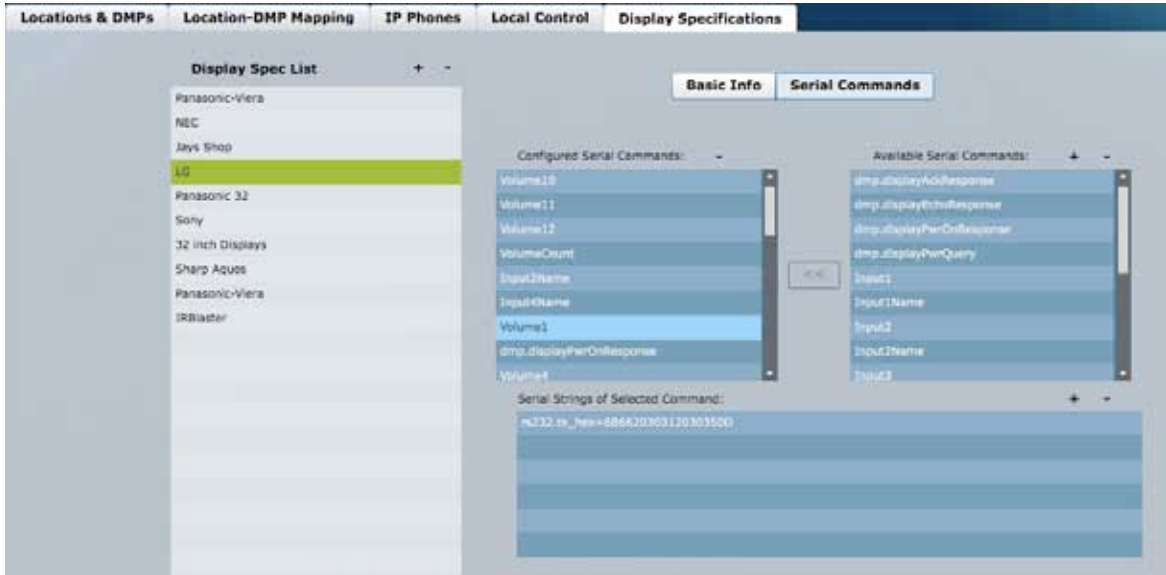

Below is an example of volume commands for an LG Display with a VolumeCount of 12.

| Serial Command | String |
|----------------|----------------------------------|
| Volume1 | RS-232.tx_hex=6B662030312030350D |
| Volume2 | RS-232.tx_hex=6B662030312031300D |
| Volume3 | RS-232.tx_hex=6B662030312031350D |
| Volume4 | RS-232.tx_hex=6B662030312032300D |
| Volume5 | RS-232.tx_hex=6B662030312032350D |
| Volume6 | RS-232.tx_hex=6B662030312033300D |
| Volume7 | RS-232.tx_hex=6B662030312033350D |
| Volume8 | RS-232.tx_hex=6B662030312034300D |
| Volume9 | RS-232.tx_hex=6B662030312034350D |
| Volume10 | RS-232.tx_hex=6B662030312035300D |
| Volume11 | RS-232.tx_hex=6B662030312035350D |
| Volume12 | RS-232.tx_hex=6B662030312036300D |

Note: It is a best practice to set Volume1 at a value above zero. A zero volume level is considered as a mute and when the user adjusts the volume up, some displays show the status bar as if their volume is turned up, but the display remains muted.

Relative Volume Commands

To define relative volume controls for the attached TV:

1. On the Serial Commands tab for the desired TV type, click the + at the upper right of the Available Serial Commands list box.
2. Click + at the upper right of the Available Serial Commands box and add a corresponding command called VolumeUp.
3. Press Enter.

The VolumeUp will automatically be selected in the available list. Click << to add it to the configured list.

4. Select the VolumeUp command in the configured list and click + at the upper right of the Serial Strings of Selected Commands. Enter the appropriate RS-232 command to increase the volume.
5. Press Enter.
6. Repeat steps 1 through 6 to define a command for VolumeDown.
7. Click **Save**.

Repeating Relative Volume Serial Commands

As previously mentioned, the VolumeUp and VolumeDown commands rely upon the incremental volume settings that are internal to each model of TV. For some TVs, the increase/decrease in volume is very slight, requiring multiple VolumeUp or VolumeDown commands to achieve the desired effect. For these TVs, you can add and define a *serial command* with the label “dmp.RelativeVolumeSteps.”

The value that you specify for dmp.RelativeVolumeSteps represents the number of times the RS-232 command for VolumeUp or VolumeDown will be repeated when you press up or down on the IR remote (or on the phone). For example, if dmp.RelativeVolumeSteps is set to 8, then a VolumeUp command will result in 8 copies of the up string being sent, rather than just one. If dmp.RelativeVolumeSteps is not set, then the default value is 1.

To define the relative volume steps:

1. On the **Serial Commands** tab for the desired TV type, click the + at the upper right of the Available Serial Commands list box.
2. Click + at the upper right of the Available Serial Commands box and add a corresponding command called dmp.RelativeVolumeSteps.
3. Press Enter.

4. The `dmp.RelativeVolumeSteps` will automatically be selected in the available list. Click << to add it to the configured list.
5. Select the `dmp.RelativeVolumeSteps` command in the configured list and click + at the upper right of the Serial Strings of Selected Commands. Enter the appropriate value for the steps (as described above).
6. Press Enter.
7. Click **Save**.

Setting a Delay Between Repeated Serial Commands

Some models of TVs discard repeated serial commands that are sent too close together. For those TVs, you can add and define a *serial command* with the label “`dmp.SerialDelay`.” The value that you specify for `dmp.SerialDelay` represents the delay between sending repeated serial commands from the DMP. By default, the value is 5000 (milliseconds). If the value is set lower, the delay between messages is decreased. Note that `dmp.SerialDelay` does not impact the rate at which other RS-232 commands are sent when more than one command is lined up for transmission.

To define the delay between repeated serial commands:

1. On the Serial Commands tab for the desired TV type, click the + at the upper right of the Available Serial Commands list box.
2. Click + at the upper right of the Available Serial Commands box and add a corresponding command called `dmp.SerialDelay`.
3. Press Enter.
4. The `dmp.SerialDelay` will automatically be selected in the available list. Click << to add it to the configured list.
5. Select the `dmp.SerialDelay` command in the configured list and click + at the upper right of the Serial Strings of Selected Commands. Enter the appropriate value for the steps (as described above).
6. Press Enter.
7. Click **Save**.

Defining Input Commands

Most TV types have multiple inputs available. For TVs in public areas, such as concourses, it is likely that only one of these inputs will be used. However, in areas with local TV control (such as clubs, back offices, locker rooms, and luxury suites), additional inputs may be used to provide connectivity to DVD players, PCs, etc. You can define labels and serial commands to control the use of these inputs.

To define input labels and serial commands:

1. On the Serial Commands tab for the desired TV type, click the + at the upper right of the Available Serial Commands list box.

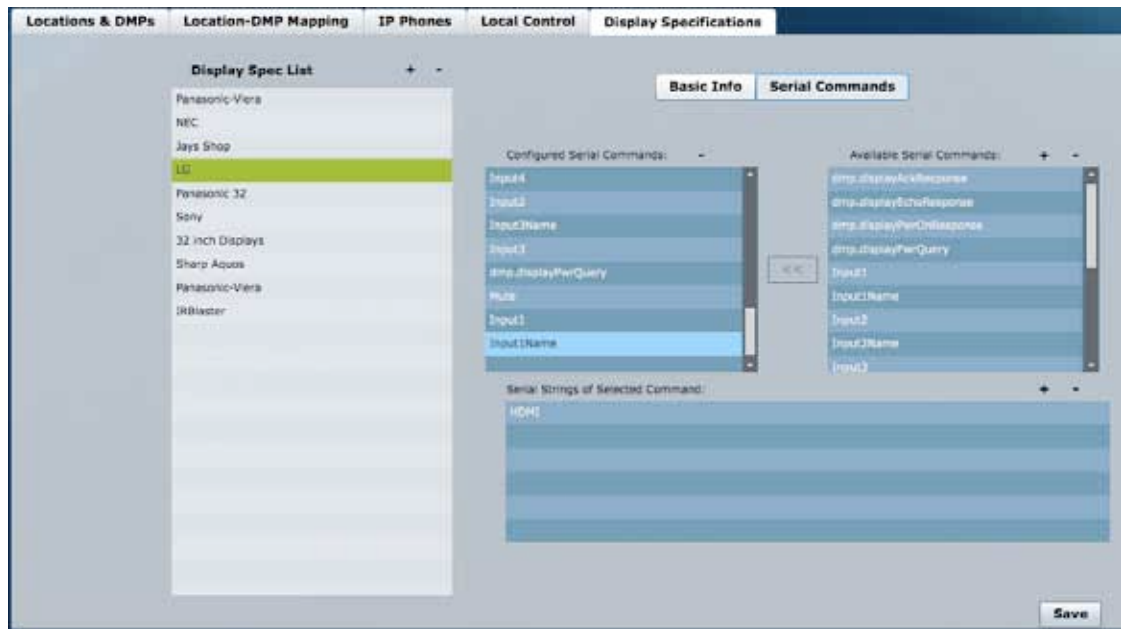

2. For each desired input (1 through 4):
 - a. Select the InputxName command in the available list and click << to add it to the configured list.
 - b. Select the InputxName command in the configured list and click + at the upper right of the Serial Strings of Selected Commands. Enter the desired label, such as HDMI or Composite, and press Enter. This label will appear on the Cisco IP Phone when a user selects the Advanced option.
 - c. Select the Inputx command in the available list and click << to add it to the configured list.
 - d. Select the Inputx command in the configured list and click + at the upper right of the Serial Strings of Selected Commands. Enter the appropriate RS-232 command for that input, and press Enter.
3. If the TV has more available inputs:
 - a. Click + at the upper right of the Available Serial Commands box and add a corresponding command called InputxName, where x is a number that identifies the input.
 - b. Select the InputxName command in the available list and click << to add it to the configured list.
 - c. Select the InputxName command in the configured list and click + at the upper right of the Serial Strings of Selected Commands. Enter the desired label.

- d. Click + at the upper right of the Available Serial Commands box and add a corresponding command called Inputx, where x is the number that identifies the input.
 - e. Select the Inputx command in the available list and click << to add it to the configured list.
 - f. Select the Inputx command in the configured list and click + at the upper right of the Serial Strings of Selected Commands. Enter the appropriate RS-232 command for that input.
4. Click Save.

TV Status

The Management Dashboard provides a summary status of each DMP and connected TV. It also reports if the TV is currently powered on or off.

The screenshot illustrates the TV status monitoring interface. It is divided into three main sections:

- Aggregate DMP Status:** A table listing DMPs with their status (On/Off), location, IP address, and MAC address.
- Main window:** A detailed view of a selected DMP, showing its status (On/Off), location, IP address, and MAC address.
- Detailed window:** A view showing the TV status for a selected DMP. It includes a 'TV Status' section with various attributes such as 'HDMI / DVS Auto Detector' (Enabled/Failed), 'RS-232 Tx Data', 'RS-232 Tx Count', 'RS-232 Rx Data', 'RS-232 Rx Count', and 'RS-232 Rx Overflow'. An 'Alerts' box points to a 'Failed' status in the 'HDMI / DVS Auto Detector' section. A 'Status Refresh' button is also visible.

The aggregate TV status includes a number of operational attributes of the TV. One such attribute is whether “HDMI Auto detection” has succeeded or failed. When “HDMI Auto detection” is disabled the value of “HDMI Auto detection status” is ignored when determining the overall TV status. A second attribute considered as part of the aggregate status is whether the RS-232 connection between DMP and TV is operational. The operational status of the RS-232 connection can only be determined if the TV supports RS-232 queries.

Displaying the actual TV power on/off status also requires that the TV supports RS-232 queries. If queries are not supported then the status simply reflects the last TV on or off command that Cisco StadiumVision Director sent to the TV. If the TV in the mean time has powered on or off from the front panel, then the dashboard may not show the true TV power state.

The DMP determines the RS-232 connection status and the TV power on/off status by sending the `dmp.displayPwrQuery` command to the TV once every 5 minutes. In return the DMP expects to receive `dmp.displayPwrOnResponse`. Depending on the response the following happens:

If a response is received, and it matches exactly `dmp.displayPwrOnResponse`, the RS-232 connection is deemed to be working, and the TV to be On.

If a response is received, but does not match exactly `dmp.displayPwrOnResponse`, the RS-232 connection is deemed working, but the TV is deemed to be powered Off. Note that the configured response string can include 'X' to indicate a wildcard match.

Finally, if no response is received at all, the RS-232 connection is deemed failed. The TV On/Off status in this case is unknown.

The `dmp.displayPwrQuery` and `dmp.displayPwrOnResponse` command/response pair is configured as part of the display specification for each TV. If a TV does not support queries then they should be left blank and no polling will occur.

Some TVs include other parameters, like volume or mute, in the response to a query. In this case it is necessary to mask these parts of the RS-232 response in order for the DMP to get an exact match when comparing the response to what has been configured for `dmp.displayPwrOnResponse`. This is achieved by using wildcards characters in `dmp.displayPwrOnResponse` to designate the parts to ignore.

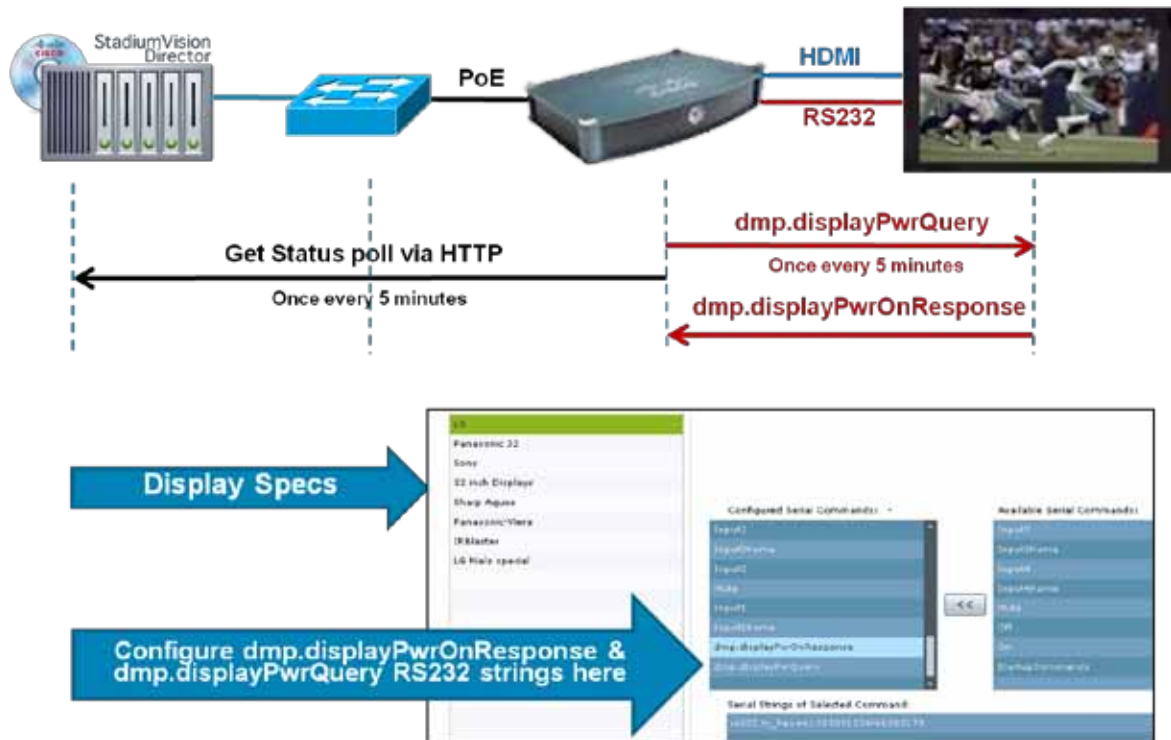

The Dashboards polling of the DMP, and the DMPs polling of the TV, are asynchronous. By default both happen every 5 minutes. As a result it can take up to 5 minutes before the dashboard status reflects the actual status of the RS-232 connection and TV On/Off status. Once a DMP becomes unreachable the dashboard starts slow polling. The default setting for slow polling is 10 minutes. The polling intervals are configurable in the SV_Director_Configuration → System_Configuration → Management_Dashboard → DMP_Health_Poller configuration panel.

Viewing the Workflow Status

There are indicators in the Cisco StadiumVision Director Management Dashboard, on the TV, and on the Control Panel that provide you information on the DMP auto-provisioning status.

Viewing the Workflow Status in the Dashboard

Once a DMP has auto-registered, you can view the auto-provisioning status through the Management Dashboard. The Provision DMP workflow progress is displayed in the Dashboard Console Window for the selected DMP. A summary of the Workflow execution is also displayed in the Checked At column in the Device List.

To view the workflow status:

1. Open the Dashboard. The Auto Registered folder should be highlighted in red indicating that there are DMPs that have been auto registered but have not been provisioned. When a number appears next to Auto Registration in the Device List, it indicates that there are DMPs that are registered but do not have any zones or groups assigned.
2. Click the Auto Registered folder and select the DMP of interest.
3. Click on the DMP of interest and then click the **Console** tab below the Device List to view a message log indicating the DMP's transition through the five auto-provisioning steps.

In the example shown in [Figure 46](#), the log messages show that auto-provisioning step 3: Stage Template is being executed. The progress is indicated as (3 of 5) in the 'Checked At' box in the Device List.

The status messages also indicate that step 2: Upgrade Firmware was skipped since the DMP already has the correct firmware image.

Figure 46. Viewing the DMP Auto-Provisioning Progress

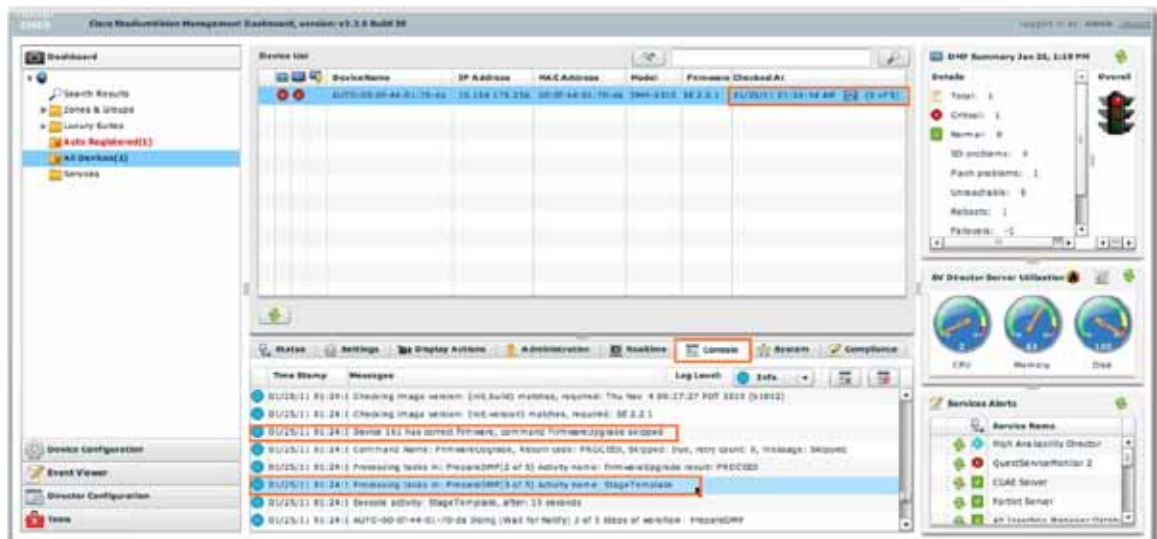

As the auto-provisioning completes, three icons in the Device List indicate the status. Refer to [Figure 47](#) and [Table 7](#).

Figure 47. Viewing Status

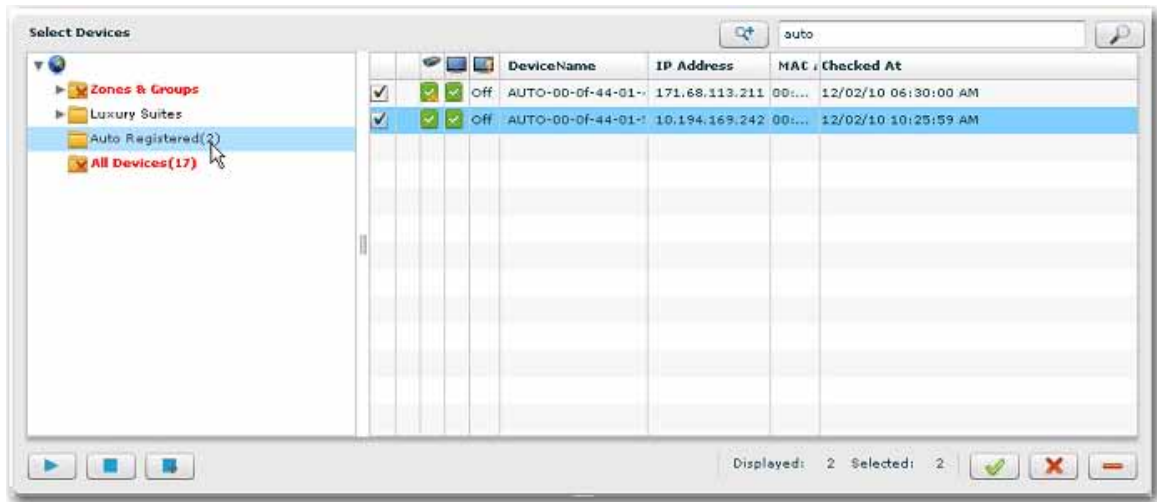





Table 7. Auto Registration Device Status Icons

| Icon | Status | Description |
|---|------------|---|
|  | DMP Status | A green check box indicates the DMP status is normal. A gold alert icon over the green check box indicates the DMP is normal but has a major or minor alert. To view more details about the alert, select the DMP and then click the Status tab below the Device List. View the alert messages in the DMP column. |
|  | TV Status | Shows red or green TV status. A red critical alert reflects that either HDMI Auto Detection failed or the RS-232 connection is down. Refer to Figure 49 . |
|  | TV State | Indicates TV Power On/Off status if the TV supports query RS-232 codes. |

You can view more detailed status on a DMP, select the DMP from the Device List and then click the **Status** tab below the Device List. Refer to [Figure 48](#).

Figure 48. Viewing Detailed Device Status

The screenshot displays a network management interface. At the top, there is a 'Select Devices' window with a search bar containing 'auto'. Below the search bar is a table of devices. The table has columns for 'DeviceName', 'IP Address', 'MAC', and 'Checked At'. The 'DeviceName' column includes icons for power, network, and status. The 'Status' column shows 'Off' for all devices. The 'Checked At' column shows the date and time of the last check, all being '12/02/10 06:30:00 AM'. The device 'prad pc' is selected and highlighted in blue.

| DeviceName | IP Address | MAC | Checked At |
|----------------------|----------------|-------|----------------------|
| AUTO-00-0f-44-01-... | 171.68.113.211 | 00... | 12/02/10 06:30:00 AM |
| AUTO-00-0f-44-01-... | 10.194.169.242 | 00... | 12/02/10 10:25:59 AM |
| rcdn 1 | 64.101.138.104 | 00... | 12/02/10 06:30:00 AM |
| rcdn 2 | 64.101.138.102 | 00... | 12/02/10 06:30:00 AM |
| 10.24.162.12 | 64.102.87.133 | | 12/02/10 06:30:00 AM |
| 64.102.87.133 | 64.102.87.133 | | 12/02/10 06:30:00 AM |
| 64.101.138.105 | 64.101.138.105 | | 12/02/10 06:30:00 AM |
| bryan dmp | 64.102.87.159 | | 12/02/10 06:30:00 AM |
| henry dmp | 171.69.66.150 | | 12/02/10 06:30:00 AM |
| mark DMP | 64.102.87.190 | | 12/02/10 06:30:00 AM |
| Dave DMP | 64.102.87.202 | | 12/02/10 06:30:00 AM |
| Wai DMP | 64.102.87.201 | | 12/02/10 06:30:00 AM |
| prad pc | 10.65.76.122 | | 12/02/10 06:30:00 AM |

Below the table, there are buttons for 'Displayed: 17' and 'Selected: 17'. The main interface has a navigation bar with tabs: Status, Settings, Display Actions, Administration, Realtime, Console, System, and Compliance. The 'Status' tab is active. On the left, there is a sidebar with 'Status Details' and sub-tabs: Uptime, Utilization, and MIB Variables. The main content area is divided into two panels: 'DMP Status' and 'TV Status'. The 'DMP Status' panel shows: Overall Health (Normal), DMP State (Not Ready), SD Card Status (Normal), Flash Status (Normal), Factory Default (No), Connectivity (Connected), Reboot (No reboot detected), Failover (No failover detected), and Compliance (Non Compliant). The 'TV Status' panel shows: HDMI / DVI Auto Detection (Enabled), HDMI Auto Detection Status (Succeeded), and RS-232 Service (Disabled).

Viewing Detailed HDMI Detection Status

To view details about the HDMI Auto Detection Status, select the DMP from the Device List and select the **Status** tab below the Device List. The HDMI Detection status displays in the TV Status column. When “HDMI Auto detection” is disabled the value of “HDMI Auto detection status” is ignored when determining the overall TV status Refer to [Figure 49](#).

Figure 49. Viewing HDMI Detection Status

The screenshot displays the Cisco management interface. At the top, the 'Select Devices' window shows a table of devices with columns for DeviceName, IP Address, MAC, and Checked At. The 'All Devices(17)' group is selected. Below this, the 'Status' tab is active, showing 'DMP Status' and 'TV Status' sections. The 'TV Status' section highlights 'RS-232 Service' as 'Disabled'.

| DeviceName | IP Address | MAC | Checked At |
|--------------------|----------------|--------|----------------------|
| AUTO-00-0f-44-01-- | 171.68.113.211 | 00:... | 12/02/10 06:30:00 AM |
| AUTO-00-0f-44-01-- | 10.194.169.242 | 00:... | 12/02/10 10:25:59 AM |
| rcdn 1 | 64.101.138.104 | 00:... | 12/02/10 06:30:00 AM |
| rcdn 2 | 64.101.138.102 | 00:... | 12/02/10 06:30:00 AM |
| 10.24.162.12 | 64.102.87.133 | | 12/02/10 06:30:00 AM |
| 64.102.87.133 | 64.102.87.133 | | 12/02/10 06:30:00 AM |
| 64.101.138.105 | 64.101.138.105 | | 12/02/10 06:30:00 AM |
| bryan dmp | 64.102.87.159 | | 12/02/10 06:30:00 AM |
| henry dmp | 171.69.66.150 | | 12/02/10 06:30:00 AM |
| mark DMP | 64.102.87.190 | | 12/02/10 06:30:00 AM |
| Dave DMP | 64.102.87.202 | | 12/02/10 06:30:00 AM |
| Wai DMP | 64.102.87.201 | | 12/02/10 06:30:00 AM |
| prad pc | 10.65.76.122 | | 12/02/10 06:30:00 AM |

| DMP Status | | TV Status | |
|-----------------|----------------------|----------------------------|-----------|
| Overall Health | Normal | HDMI / DVI Auto Detector | Enabled |
| DMP State | Not Ready | HDMI Auto Detection Status | Succeeded |
| SD Card Status | Normal | RS-232 Service | Disabled |
| Flash Status | Normal | | |
| Factory Default | No | | |
| Connectivity | Connected | | |
| Reboot | No reboot detected | | |
| Failover | No failover detected | | |
| Compliance | Non Compliant | | |

Querying the Auto-Provisioning Status

1. Open the Dashboard and select **Device Configuration > Auto Registration**.
2. Click **Provision DMP**.
3. In the command parameters area for Operation under the Common tab, click on Value and select Query from the Value drop down menu. See [Figure 50](#).
4. When you run the Query command on a device, the **Console** tab will display which provisioning step has been completed for the selected device.

Figure 50. Querying the Auto-Provisioning Status

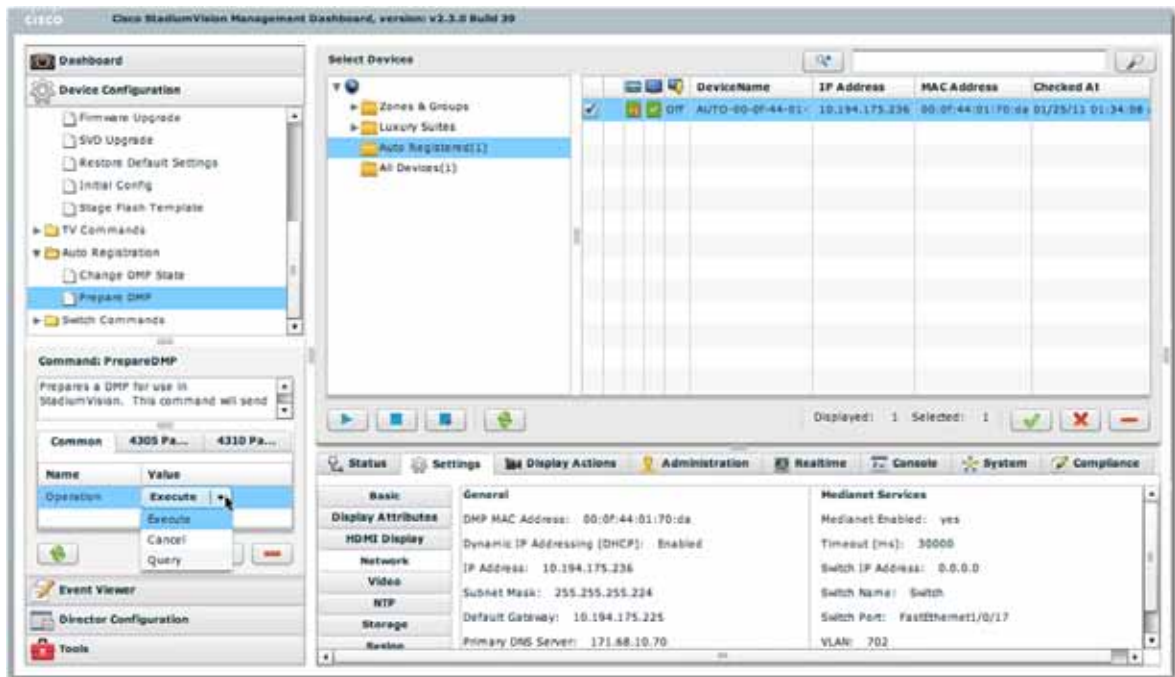

5. When the DMP state is listed as 'In Production' auto-provisioning has successfully completed. See [Figure 51](#).

Figure 51. Viewing the DMP State (Production)

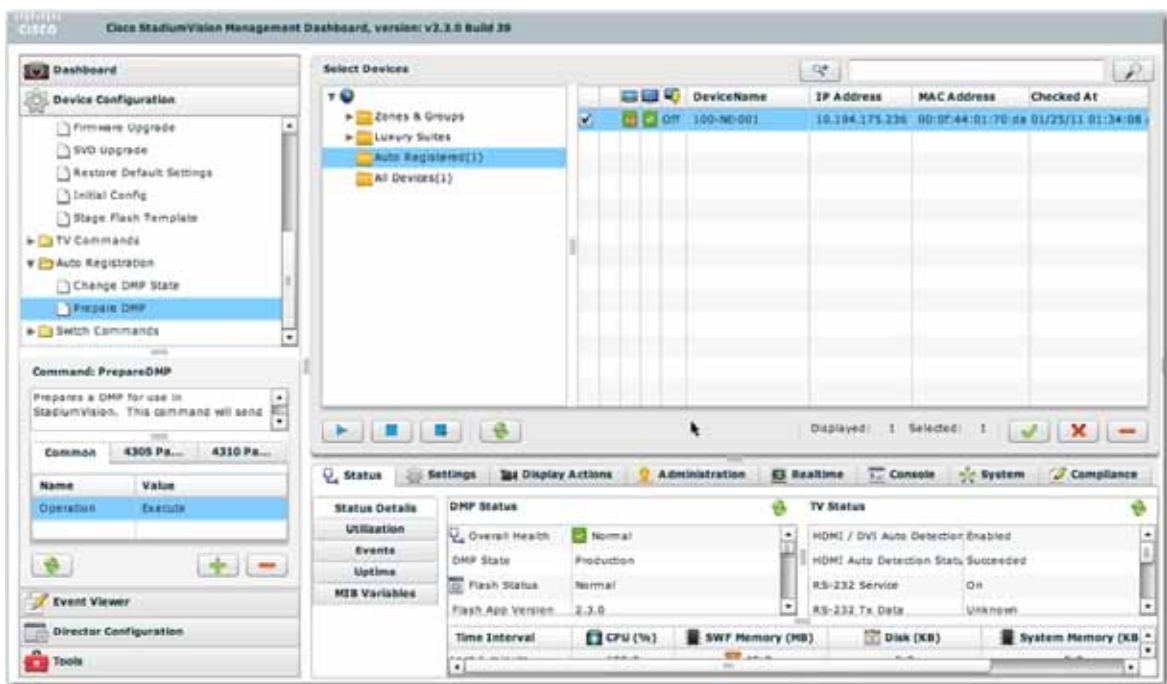

Viewing Auto-Provisioning Status on the TV

Once the auto-provisioning workflow reaches step 4 the DMP is sufficiently initialized to be able to display the progress of the remaining auto-provisioning workflow. At this point the TV screen displays:

- The barcode for the DMP MAC address.
- A ticker showing the MIB variables, IP address, CDP variables, and switch settings.
- Intermediate status of the auto-provisioning. This tells you what step you are on in the auto-provisioning, what step is next, and what is happening to the DMP (e.g., transitioning to the ready state).

When auto-provisioning is finished, the default video channel displays on the TV, along with a “Completed!” status message. If the Completed message does not display, auto-provisioning has not been successful.

Viewing the DMP Readiness State in the Control Panel

To view which state (Not Ready, Ready, In Production) the DMP is in during auto-registration and provisioning:

1. Open the Control Panel.
2. Select **Setup > Devices**.
3. Select the **Locations & DMP** tab to display DMP information, including the current state. The State column will display ‘Ready’ when the DMP has been auto-provisioned but is yet to be mapped to a Location. Refer to [Figure 52](#).

Figure 52. Viewing the DMP Readiness State

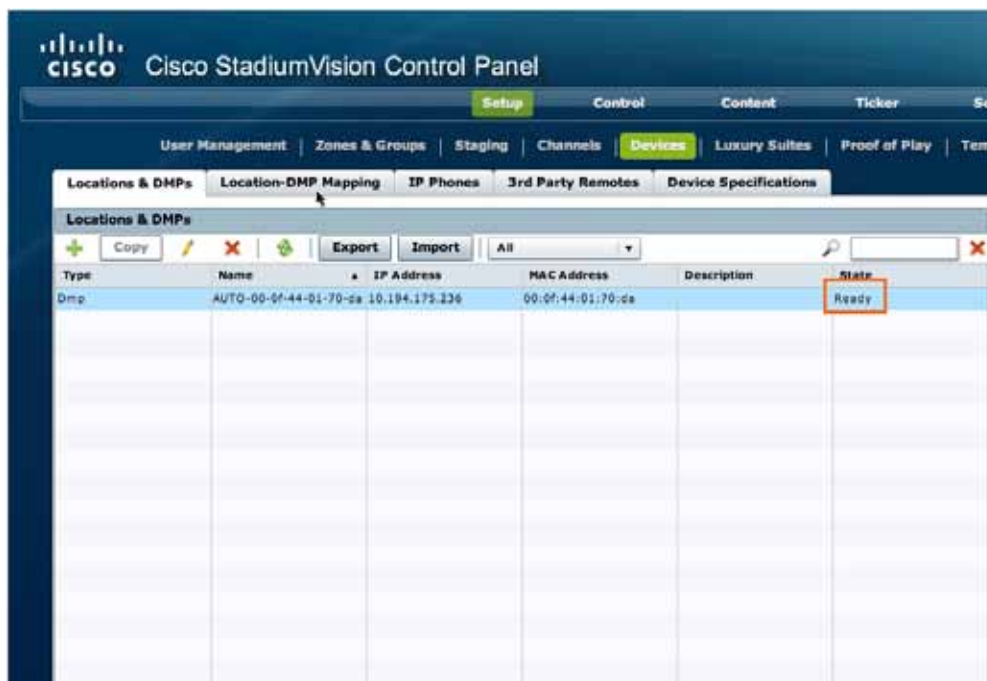

The screenshot shows the Cisco StadiumVision Control Panel interface. The 'Locations & DMPs' tab is selected, displaying a table with the following data:

| Type | Name | IP Address | MAC Address | Description | State |
|------|------------------------|----------------|-------------------|-------------|-------|
| Dmp | AUTO-00-0f-44-01-70-da | 10.194.175.236 | 00:0f:44:01:70:da | | Ready |

DMPs and Locations

Managing DMP and Location Objects

There are two methods that can be used to create, delete and update a DMP or Location. Each of these operations can be done manually in a one-by-one manner or done in bulk by editing and uploading a tab separated value (TSV) file. These operations are performed in the **Setup>Devices>Locations & DMPs** web interface.

Figure 53. Navigating the Locations & DMPs Web Interface

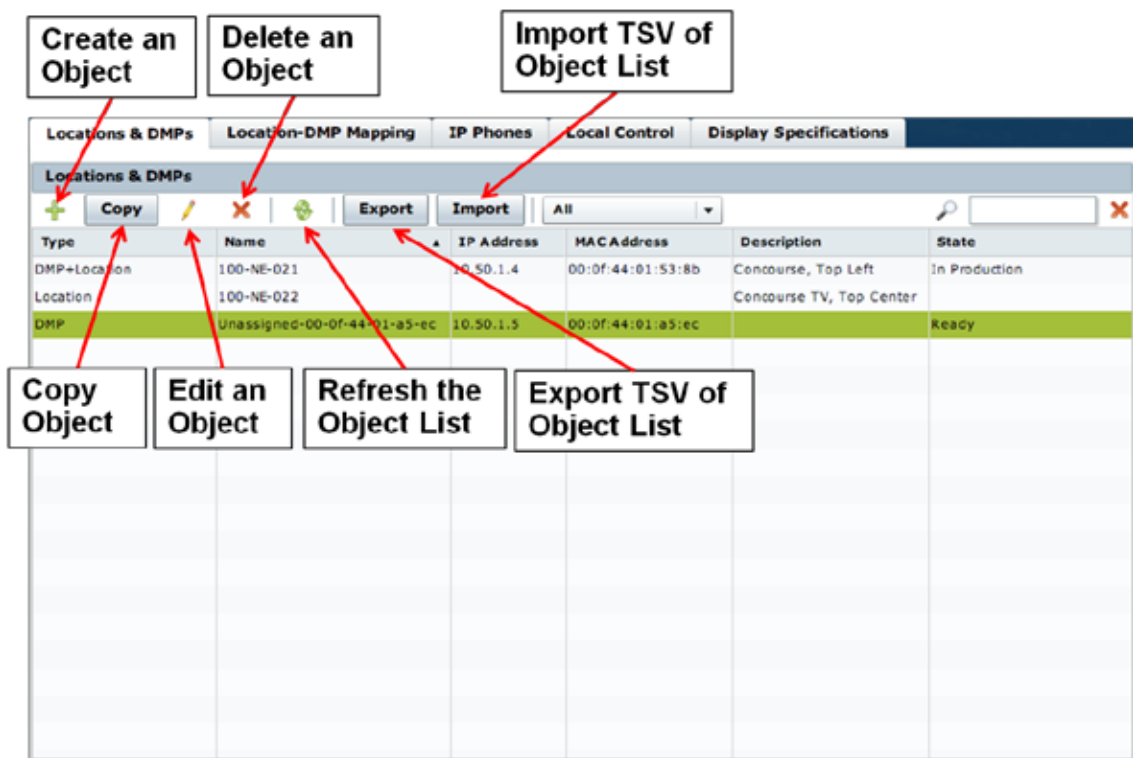

Manual Administration

To manually add a DMP or Location object:

1. Open the Control Panel.
2. Select **Setup>Devices>Locations & DMPs**.
3. Click the + to bring up the Create New menu.
4. Click the drop-down menu to choose the object to be created.
5. Type in the required information highlighted by the asterisk and any additional information as desired.

Figure 54. Manually Creating a DMP, Location, DMP+Location Object



Bulk Administration

Due to the high number of DMPs and other devices (e.g., IP Phones, 3rd Party devices) TSV files are often used for uploading the device information into Cisco StadiumVision Director. The TSV file requires a specific set of columns, column title syntax and column order to be compatible with Cisco StadiumVision Director. The best way to make sure the TSV file is compatible is to export a TSV file from Cisco StadiumVision Director and use that as a template when building a Cisco StadiumVision Director compatible TSV file.

Figure 55. Exporting a TSV file from Cisco StadiumVision Director

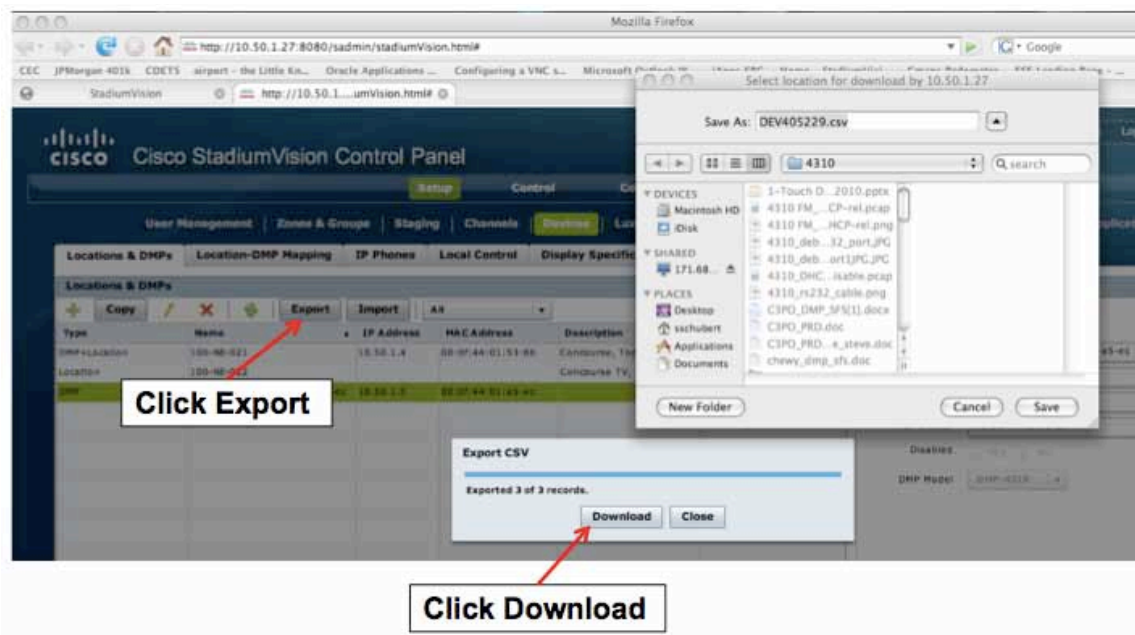

Figure 56. Cisco StadiumVision Director TSV Defined

| | A | B | C | D | E | F | G | H | I | J | K | L | M |
|---|----------------|------------|-------------------|------------|------------------------------|----------|------------|------------|------------|--------------|--------------------------|---------|-----|
| 1 | Operation Type | Entry Type | MAC Address | IP Address | Name | Old Name | Model Name | LocationID | State | Service Type | Description | TV Type | Sub |
| 2 | | LOCATIONn | 00:0f:44:01:53:8b | 10.50.1.4 | 100-NE-021 | | DHP-4310 | 1003 | Production | | Concourse, Top Left | LG | |
| 3 | | LOCATION | | | 100-NE-022 | | | | | | Concourse TV, Top Center | LG | |
| 4 | | DMP | 00:0f:44:01:a5:ec | 10.50.1.5 | Unassigned-00-0f-44-01-a5-ec | | DHP-4310 | 1004 | Production | | | | |
| 5 | | | | | | | | | Ready | | | | |
| 6 | | | | | | | | | | | | | |
| 7 | | | | | | | | | | | | | |

If using an existing TSV from a previous StadiumVision installation then modify the column order, add the Operation Type and Entry Type columns and verify that all columns and column headers are organized the same as the exported TSV. Then use the Operation Type and Entry Type columns for creating, deleting and updating entries in the TSV.

Note: MAC address can be entered in BAT in one of these 3 formats:

1. aa:bb:cc:dd:ee:ff - Cisco StadiumVision Director format
2. aabbccddeeff - format on bar code label on bottom of 4310)
3. aabb.ccdd.eeff - IOS format

Refer to the [Cisco StadiumVision Director Bulk Administration Tool](#) guide for details on how to use the Bulk Administration Tool.

Process Recommendation

Using bar code scanners as part of the installation process can increase the speed and accuracy of DMP deployment. When combined with TV labels that include the Location Name in bar code format, the installation workflow goes something like this.

1. Installer mounts the TV and DMP.
2. Installer cables the TV and DMP.
3. While DMP is auto-registering the installer attaches pre-printed label to TV.
4. Installer then scans the Location bar code on the TV.
5. Installer also scans the MAC address bar code on the DMP.

At the end of their shift, the installer returns the bar code scanner to the supervisor. The supervisor downloads the scanned data and formats it to be compatible with the BAT TSV file format. Part of the data formatting involves aligning MAC address and Location into two columns along side of each other. The scanned timestamp can be used to correlate the DMP MAC to the TV Location.

Note: The MAC address bar code on the DMP is very small and is a challenge for some bar code scanners. In particular smart phone based scanners that use the CCD camera generally do not work well. The following is a list of sub-\$200 bar code scanners that have been tested and found to work.

www.motorola.com/CS3000

<http://www.honeywellaidc.com/promos/3800q/>

Here is an example of a label printer that can print bar code:

<http://www.amazon.com/dp/B000ZHEVZ8>

6. Import the TSV into Cisco StadiumVision Director and verify the import results match what was intended. If an error occurs during Import, an error report will be generated. Open the report to see where the error occurred.

Figure 57. Download TSV Error Report

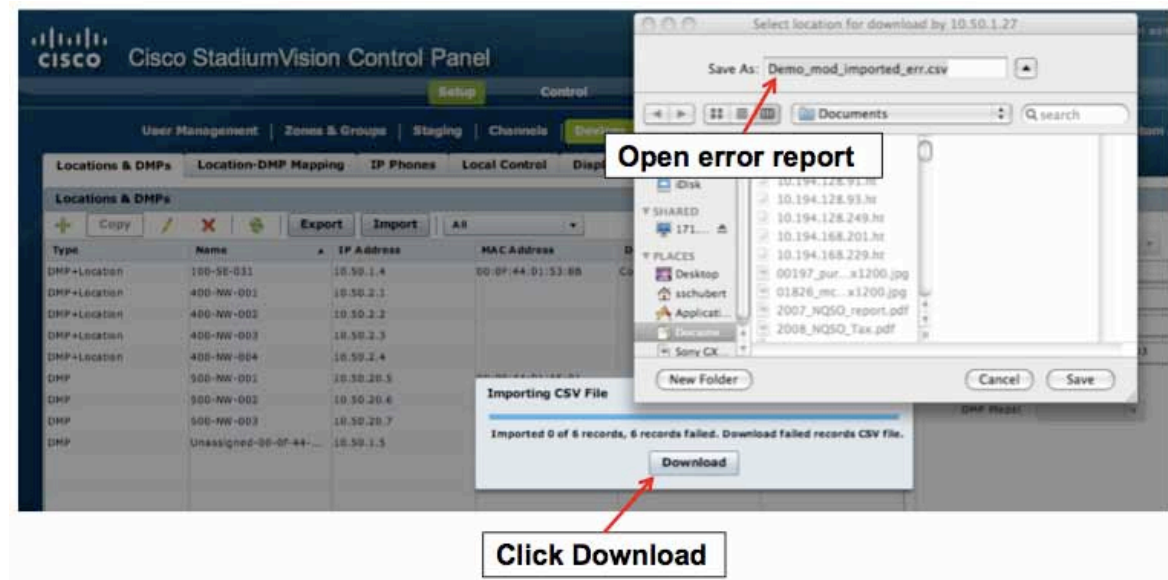

Figure 58. Example TSV Error Report

| | A | B | C | D | E | F | G | H |
|---|------------------------|----------------|------------|-------------|------------|------|----------|-----------|
| 1 | Error Text | Operation Type | Entry Type | MAC Address | IP Address | Name | Old Name | Model Nan |
| 2 | Deivce Name is Empty** | create | LOCATIONn | | 10.100.1.1 | | | |
| 3 | Deivce Name is Empty** | create | LOCATIONn | | 10.100.1.2 | | | |
| 4 | Deivce Name is Empty** | create | LOCATIONn | | 10.100.1.3 | | | |
| 5 | Deivce Name is Empty** | create | LOCATIONn | | 10.100.1.4 | | | |
| 6 | Deivce Name is Empty** | create | LOCATIONn | | 10.100.1.5 | | | |
| 7 | Deivce Name is Empty** | create | LOCATIONn | | 10.100.1.6 | | | |

Mapping a DMP to a Location

The final step to readying the DMP for production is linking it with a Location. The linking operation can be done manually in a one-by-one manner or done in bulk by editing and uploading a TSV file. These operations are performed in the **Setup > Devices > Locations-DMP Mapping** web interface.

Figure 59. Navigating the Locations-DMP Mapping Web Interface

Manual Mapping

To manually map a DMP to a Location:

1. Select **Setup > Devices > Locations-DMP Mapping**.
2. Click on an available device under the MAC Address listing and click on a Location Name. The two objects should be highlighted ([Figure 59](#)).
3. Click on the Link button to link the two objects ([Figure 60](#)). The MAC address that was highlighted will move to the Locations listing section of the screen.
4. Use the "Unlink" operation to disassociate a DMP from a Location. Once the DMP has been disassociated it is renamed as "Unassigned-xx-xx-xx-xx-xx-xx" (where xx-xx-xx-xx-xx-xx is the MAC address).The Location can now be linked to a different DMP.

Figure 60. Manually Linking a DMP to a Location

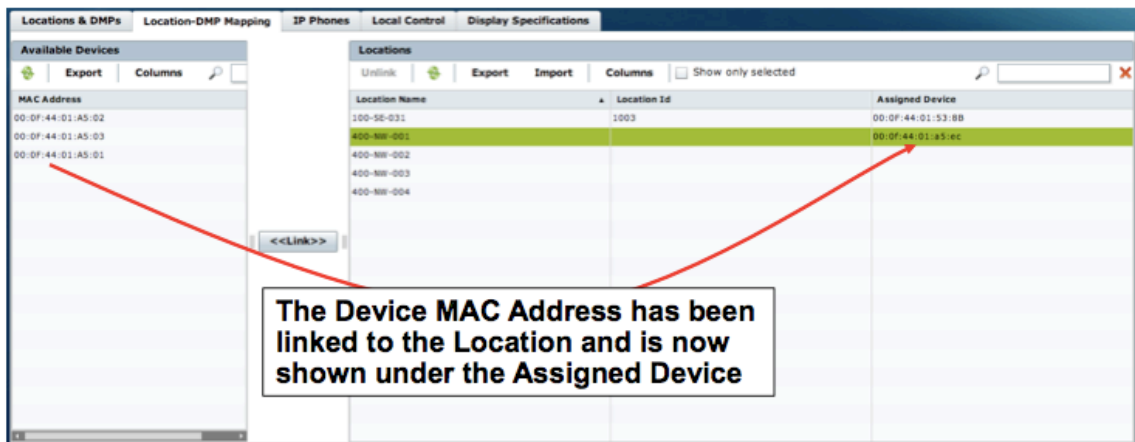

Bulk Mapping

As mentioned previously, TSV files may be used for uploading the device (i.e., DMP) and Location information into Cisco StadiumVision Director. The TSV file requires a specific set of columns, column title syntax and column order to be compatible with Cisco StadiumVision Director. The best way to make sure the TSV file is compatible is to export a TSV file from Cisco StadiumVision Director and use that as a template when building a Cisco StadiumVision Director compatible TSV file. [Figure 61](#) shows the two TSV files available for export. [Figure 62](#) shows how the Search utility can be used to filter what will be exported out of Cisco StadiumVision Director.

Figure 61. Export of Available Devices and Locations TSV Files

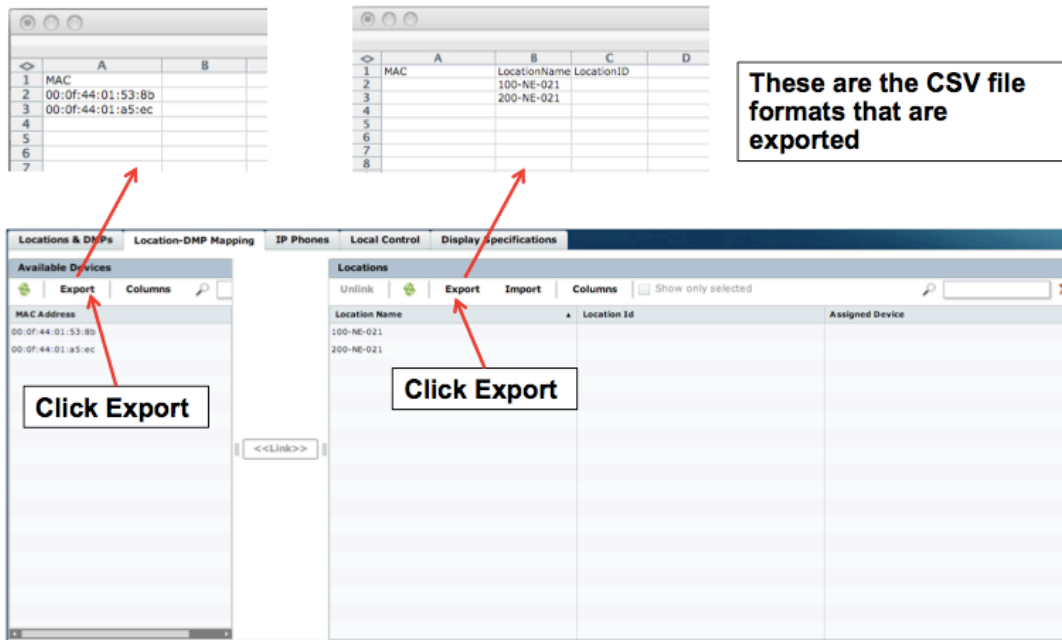
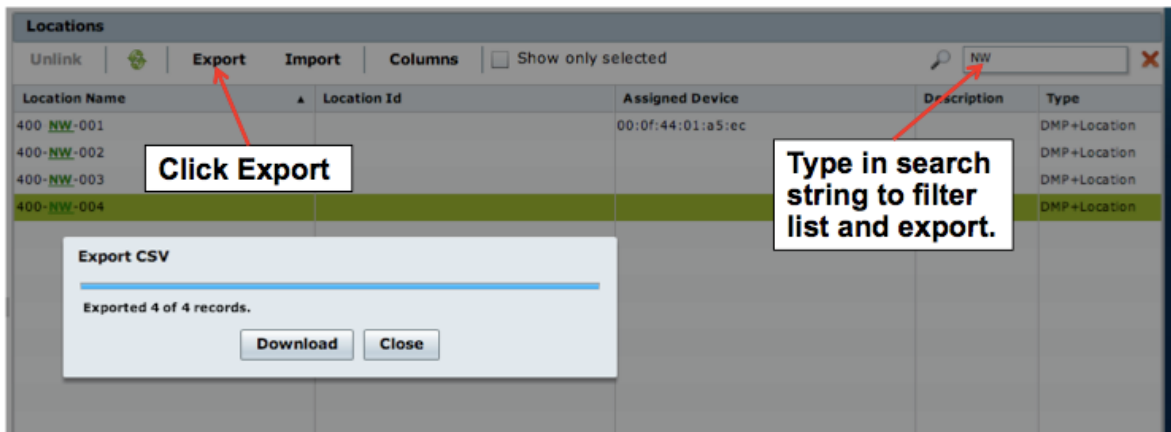
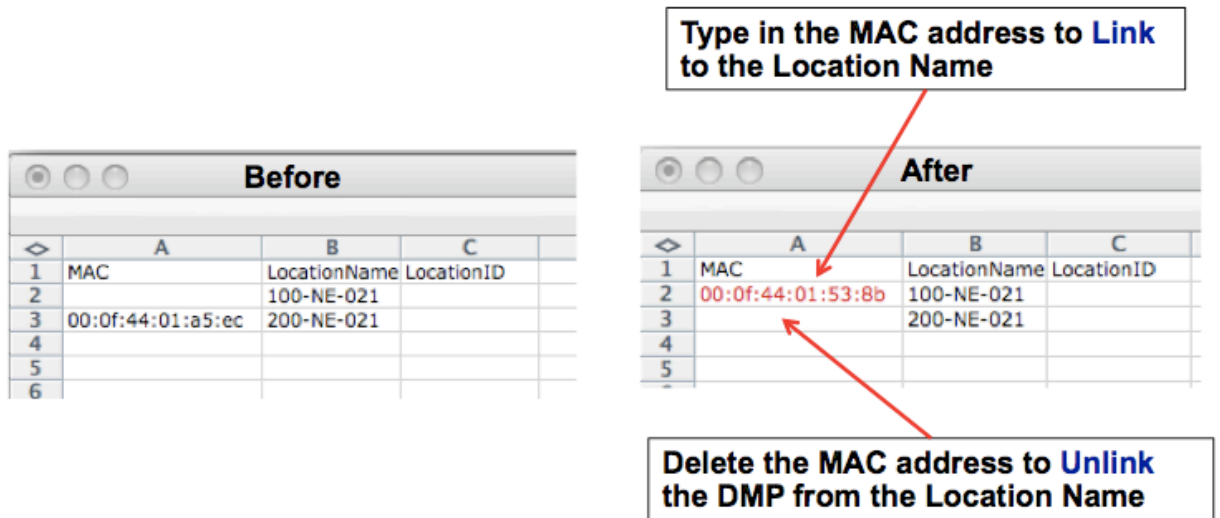

Figure 62. Using the Search Utility to Filter and Export a TSV File



Once Locations and DMP objects are created in the Locations & DMPs screen, a TSV Import may be used to Link or Unlink objects. Notice the insertion of the MAC address creates the Link to Location Name 100-NE-21 and the deletion of the MAC address unlinks the DMP from Location Name 200-NE-021.

Figure 63. Using the TSV File to Link/Unlink DMP to Locations



When a DMP that is in the “Ready” state is linked to a Location, it is then placed into the “In Production” state and is ready to be placed into its appropriate Groups and Zones. [Figure 64](#) illustrates the results of the Link and Unlink operations performed above with the TSV file import.

Figure 64. Results from the TSV File Import on the Locations & DMPs Screen

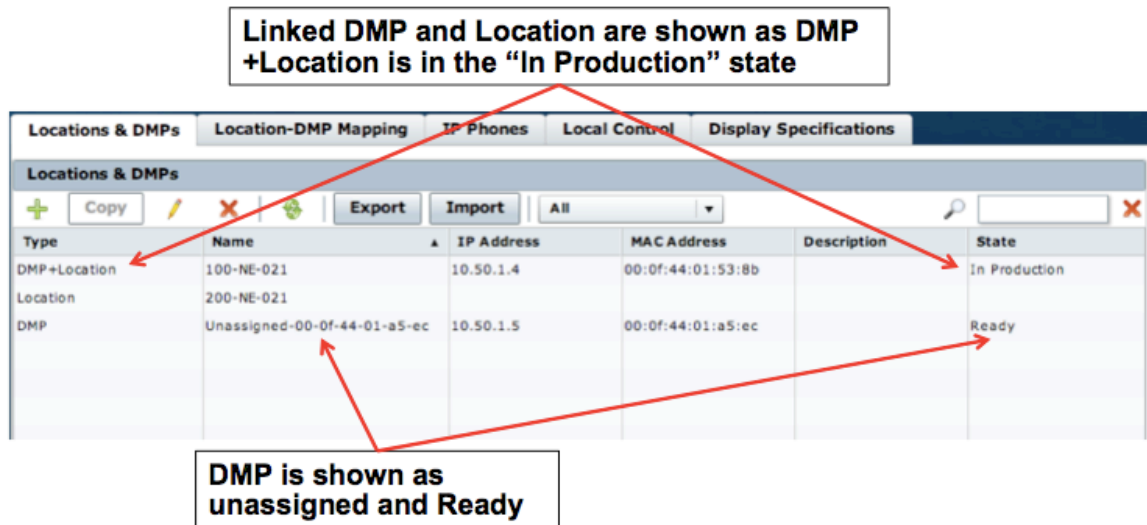

In summary, the DMPs can be auto-registered with Cisco StadiumVision Director or uploaded via a TSV file. Provisioning of the DMP can be done automatically or manually to prepare it for production. Once the DMP is provisioned and in the “Ready” state, linking it to a physical Location Name can be done manually in a one-by-one manner or in bulk via a TSV file import. Once this linking is complete, the Location is placed into the “In Production” state and ready to display content.

Chapter 4 Tips and Best Practices

This section contains tips and best practices for StadiumVision endpoint (DMP) operations.

Verifying the DMP Display Attributes

To verify that the DMP and the TV agree on the most optimal display settings:

1. On the Dashboard, select **Configuration > Monitoring > Get Status**.
2. Select the DMP and execute the **Get Status** command by pressing the Play button.
3. Under the **Settings** tab at the bottom of the Dashboard screen, click **HDMI Display** and check the settings for the HDMI information the DMP received from the TV.
4. Verify that the native resolution of the TV display matches the HDMI format indicated as “native.”

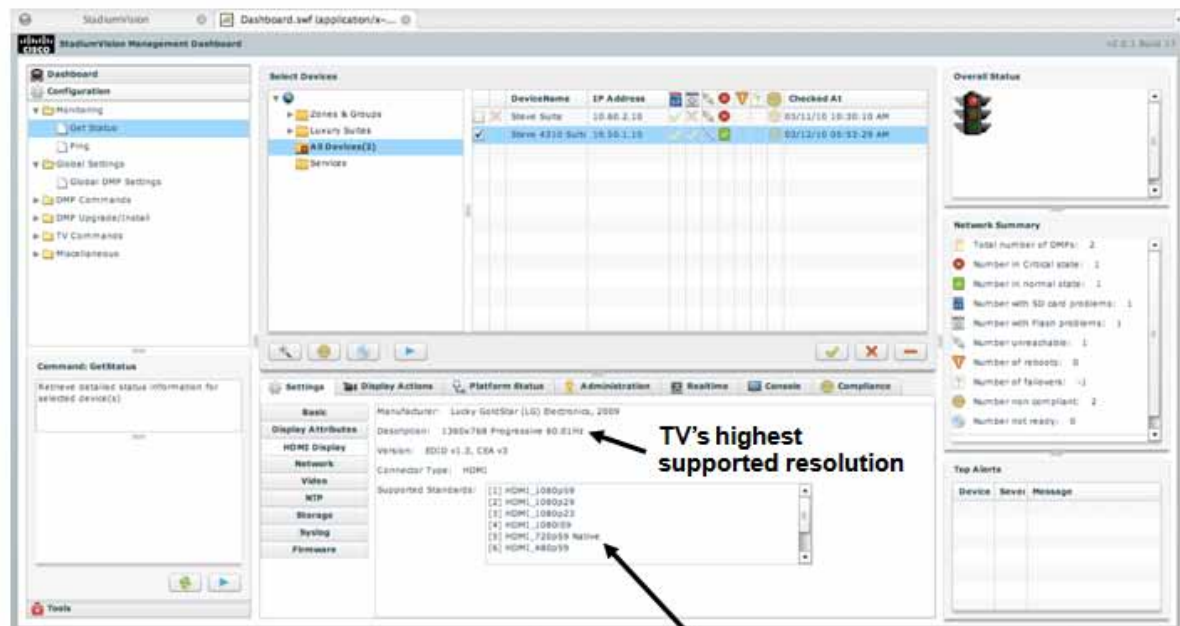

Once the DMP and TV are properly displaying the desired graphics and video, additional tuning may be required such as setting the aspect ratio of the TV itself. [Figure 65](#) shows an example of how to identify and adjust the TV's Aspect Ratio.

Figure 65. Adjusting the TV's Aspect Ratio



Note:

- TVs typically will retain settings made via their Settings menu. However, if an equivalent RS-232 control command is supported, StadiumVision Director may be used to set this on the TV upon script initiation or for doing a bulk setting across a number of DMP-connected TVs. See the section on Configuring Display Specifications.
- Some older TVs do not have the ability to adjust for over scan. If the picture requires adjustment, the DMP provides a way to scale and position the picture. See the section on Configuring Display Specifications.

Domain Name Service

DNS name resolution is not required for DMPs to operate in the StadiumVision solution. In fact, if a DMP is configured with a DNS server, and that server becomes unreachable, then system operation will slow. This is because DMPs perform reverse DNS lookups when a DNS server is configured. Therefore, it is recommended that you not configure the DMPs with a DNS server. Since DHCP is typically used this means that the DHCP scope for the DMPs should not include a DNS server.

Replacing a failed DMP

Situation: Due to a hardware failure, a DMP needs to be replaced while the event script is running.

Challenge: Once you have replaced the failed DMP, you want the new DMP to follow the same scripted behavior as its predecessor.

The new DMP should:

- Belong to the same groups and zones.
- React to the zone/group state actions.
- Display the same content as the DMP its replaces.

Solution:

1. Unplug the failed DMP and replace it with a new DMP.
2. Wait until auto-registration/provisioning completes, and the new DMP shows in the dashboard with state 'Ready'.
3. In the control panel un-map the old DMP from its Location, and map the new DMP to this Location.
4. From the control panel manually stage content to the new DMP.
5. Verify that the new DMP is showing the expected content.
6. Delete the failed DMP from Cisco StadiumVision Director. This DMP will be named as "Unassigned-xx-xx-xx-xx-xx-xx", where xx-xx-xx-xx-xx-xx is the MAC address.

Configuring CDP in the DMP

The DMP, starting with firmware version SE 2.2.1 build 1932, supports Medianet services, which includes Cisco Discovery Protocol (CDP). This capability allows the switch and DMP to learn about each other by exchanging CDP messages. At the switch CLI, the `show cdp neighbor` command displays the DMPs that are connected to the switch. This information can be very useful when troubleshooting DMP issues.

```
Training_SW#show cdp neighbor
Capability Codes: R - Router, T - Trans Bridge, B - Source Route Bridge
                  S - Switch, H - Host, I - IGMP, r - Repeater, P - Phone,
                  D - Remote, C - CVTA, M - Two-port Mac Relay

Device ID           Local Intrfce   Holdtme    Capability  Platform  Port ID
SEP081735D5E79A     Gig 0/1         173        H P M       IP Phone  Port 1
SEP081735D5E72F     Gig 0/9         174        H P M       IP Phone  Port 1
00:0f:44:01:b5:50   Gig 0/7         171        H           DMP 4310G eth0
SEP081735D5E749     Gig 0/6         174        H P M       IP Phone  Port 1
sande-cucm          Gig 0/24        137        H           VMware Vi eth0
SEP081735D5E6DF     Gig 0/8         175        H P M       IP Phone  Port 1
00:0f:44:01:a8:d7   Gig 0/10        175        H           DMP 4310G eth0
00:0f:44:01:b6:c3   Gig 0/5         167        H           DMP 4310G eth0
00:0f:44:01:bf:60   Gig 0/11        177        H           DMP 4310G eth0
```

CDP information pertaining to the connected switch port can be viewed in the Cisco StadiumVision Director Management Dashboard.

The screenshot displays the Cisco StadiumVision Director web interface. On the left is a navigation sidebar with options like 'Dashboard', 'Search Results(0)', 'Zones & Groups', 'Luxury Suites', 'Auto Registered(4)', 'All Devices(4)', and 'Services'. The main area shows a 'Device List' table with columns for Location, IP Address, MAC Address, Model, Firmware, and Checked At. Below the table are tabs for Status, Settings, Display Actions, Administration, Realtime, Console, System, and Compliance. The 'Settings' tab is active, showing configuration for a switch. The 'Network' sub-tab is selected, and the 'Medianet Services' section is circled in red, showing details like 'Medianet Enabled: yes', 'Timeout (ms): 30000', 'Switch IP Address: 10.194.172.1', 'Switch Name: Training_SW', 'Switch Port: GigabitEthernet0/5', 'VLAN: 10', 'Location ID: POD1', and 'Location URL: 22+POD1&28=Cookie_Monster&27=2&25=C'.

| Location | IP Address | MAC Address | Model | Firmware | Checked At |
|------------------------|----------------|-------------------|----------|----------|----------------------|
| AUTO-00-0F-44-01-06-C3 | 10.194.172.122 | 00:0F:44:01:06:C3 | DMP-4310 | SE 2.2.1 | 02/13/11 06:20:47 AM |
| AUTO-00-0F-44-01-05-50 | 10.194.172.121 | 00:0F:44:01:05:50 | DMP-4310 | SE 2.2.1 | 02/13/11 06:21:01 AM |
| AUTO-00-0F-44-01-08-07 | 10.194.172.123 | 00:0F:44:01:08:07 | DMP-4310 | SE 2.2.1 | 02/13/11 06:21:17 AM |
| AUTO-00-0F-44-01-0F-60 | 10.194.172.124 | 00:0F:44:01:0F:60 | DMP-4310 | SE 2.2.1 | 02/13/11 06:21:30 AM |

Configuring Civic Location in the Switch

IOS civic location is a collection of labels that can be configured on each switch port, and then communicated to the DMP via CDP. One use case for civic location is jack ID, hence allowing the DMP to learn what Ethernet jack it is connected to. The DMP reports any civic location information it learns back to Cisco StadiumVision Director, where it can be retrieved and displayed by Cisco StadiumVision Director as shown above. It can also be viewed directly in the DMP's web interface.

The following example shows the civic location being configured and applied to interface gigabit Ethernet 0/5:

```

Training_SW#configure terminal
Enter configuration commands, one per line. End with CNTL/Z.
Training_SW(config)#location civic-location identifier 1
Training_SW(config-civic)#? Type ? to see all the options of configuring the location.
Training_SW(config-civic)#additional-location-information POD1
Training_SW(config-civic)#building C
Training_SW(config-civic)#floor 2
Training_SW(config-civic)#room Cookie_Monster
Training_SW(config-civic)#end
Training_SW#conf t
Enter configuration commands, one per line. End with CNTL/Z.
Training_SW(config)#int g0/5
Training_SW(config-if)#location civic-location-id 1
Training_SW(config-if)#end

```



```

Training SW#conf t
Enter configuration commands, one per line. End with CNTL/Z.
Training SW(config)#location civic-location identifier 1
Training SW(config-civic)#?
Type ? to see all the options of configuring the location.
Training SW(config-civic)#additional-location-information POD1
Training SW(config-civic)#building C
Training SW(config-civic)#floor 2
Training SW(config-civic)#room Cookie Monster
Training SW(config-civic)#end
Training SW#conf t
Enter configuration commands, one per line. End with CNTL/Z.
Training SW(config)#int g0/5
Training SW(config-if)#location civic-location-id 1
Training SW(config-if)#end

```

| Mediaview Services | |
|--------------------|-------------------------------------|
| MediaNet Enabled | On |
| Timeout (ms) | 30000 |
| Switch IP Address | 10.194.172.1 |
| Switch Name | Training_SW |
| Switch Port | GigabitEthernet0/5 |
| VLAN | 10 |
| Location ID | POD1 |
| Location URL | 22+POD1&2B+Cookie_Monster&27+2&25=C |

The civic location feature is only supported in 2xxx and 3xxx series switches, and only when they are running IOS 12.2.55SE1 or later. It is currently not supported in the 65xx switches.

IOS civic location information can be viewed in the Management Dashboard, but Cisco StadiumVision Director does not use the civic location information to automatically link the DMP to its target SV Location.

Chapter 5 Troubleshooting

This chapter provides basic troubleshooting information for resolving problems you may encounter with DMPs and the attached TVs.

Auto-Registration Issues

Follow these step by step directions to follow the auto-registration flow and look for common problems. Several steps involve viewing the relevant log files. These log files can be viewed from either TUI or from the unix shell. Viewing them from the TIU can be challenging as the ability to filter on the fly is limited.

Step 1: Make sure the DMP is in its factory default state. This can be ensured by depressing the reset button on the back of the DMP for 10 seconds, or until the LED on the Ethernet port turns solid green.

Step 2: Confirm that the DMP receives an IP address via DHCP. When an IP address is received the DMP turns off the red LED on the front and displays the IP address on the monitor. Auto-registration does not work with static IP addressing.

Step 3: Establish an ssh session to the DMP and run the `udhcpc` command. Verify the option 43 URL received from the DHCP server. This URL appears on the last line of the output. Verify that it contains the IP address of your Cisco StadiumVision Director server, and that it is formatted as per the documentation:

```
[guest@svd1 ~]$ ssh root@10.10.99.20
root@10.10.99.20's password: <password can be found in SVD registry>
4310 10.10.99.20 # udhcpc
udhcpc (v1.15.2) started
  /sbin/ifconfig eth0 0.0.0.0
Sending discover...
Sending select for 10.10.99.20...
Lease of 10.10.99.20 obtained, lease time 86400
  /sbin/ifconfig eth0 10.10.99.20 netmask 255.255.255.0
  /sbin/route del default gw 0.0.0.0 dev eth0
route: SIOCDELRT: No such process
  /sbin/route add default gw 10.10.99.1 dev eth0
  adding domain cisco.com
Calling vendor notification: http://10.194.172.82:8080/StadiumVision/dmp_reg
```

Step 4: Ping the DMP from Cisco StadiumVision Director to confirm that there is two-way IP connectivity between them.

Step 5: Check the Apache logs on Cisco StadiumVision Director to verify that the auto-registration URL that the DMP received as a DHCP option reaches Cisco StadiumVision Director. The following shows that URL `/StadiumVision/dmp_reg` posted by 10.10.99.20 has been received. Cisco StadiumVision Director responds with status code 200 (OK), indicating that it recognizes this URL and is able to process it:

```
[guest@svd1 httpd]# pwd
/var/log/httpd
[guest@svd1 httpd]# grep 10.10.99.20 access_log
10.10.99.20 - - [08/Sep/2011:06:00:35 -0600] "POST /StadiumVision/dmp_reg
HTTP/1.1" 200 6796 "-" "curl/7.19.6 (mipsel-unknown-linux-gnu) libcurl/7.19.6
OpenSSL/0.9.8o zlib/1.2.3 c-ares/1.7.3"
```

Step 6: Confirm that auto-registration has been enabled. If auto-registration is disabled then the following error message will appear in the sv_dev_debug.log file. The same message will also appear in the dashboard under the System tab.

```
[guest@svd1 logs]# pwd
/opt/sv/servers/config/logs
[guest@svd1 logs]# egrep -i 'auto-registration' sv_dev_debug.log
2011-09-08 06:17:16,000 [HPMThreadPoolExecutor-ThreadPool-system] INFO
com.cisco.sv.tools.common.SvLoggerFactory - Auto registration is disabled.
Discarding registration message from: 10.10.99.20
```

Step 7: Confirm that auto-provisioning has been enabled. If auto-provisioning is not enabled then the following error message will appear in the sv_dev_debug.log file. In this case there is no corresponding message posted in the dashboard.

```
[guest@svd1 logs]# pwd
/opt/sv/servers/config/logs
2011-09-08 06:26:55,574 [HPMThreadPoolExecutor-ThreadPool-system] INFO
com.cisco.sv.hpm.endpoint.dmp.CompositeCommand - Auto provision is disabled,
device com.cisco.sv.hpm.endpoint:type=DMP,id=181 ,name=181-ip-10-10-99-20-mac-00-
0f-44-01-57-b7 must be manually provisioned by using the 'Provision DMP' command
```

Step 8: Make sure that the DMP trying to auto-register is not already present in the Cisco StadiumVision Director database. If it is present then Cisco StadiumVision Director will assume this is an existing DMP that is simply rebooting and hence ignore the auto-registration request. The following error messages will appear in the sv_dev_debug.log file. The same message will also appear in the dashboard under the System tab, but not under the Console tab as you might expect since the DMP in question is listed in the dashboard. To correct this situation either delete the DMP from the database or change its state to 'Not Ready'.

```
[guest@svd1 logs]$ egrep -i 'NEW|10.10.99.30' sv_dev_debug.log
2011-10-20 22:01:06,847 [TP-Processor10] 9968bfae INFO
com.cisco.sv.autoregister.DMPAutoRegister - Received DMP auto register message
from: 10.10.99.30 message: 00:0f:44:01:57:b7
2011-10-20 22:01:22,204 [HPMThreadPoolExecutor-ThreadPool-system] INFO
com.cisco.sv.tools.common.SvLoggerFactory - Device 'Boulder-A' is not 'NEW',
ignoring register message
```

Step 9: Examine the sv_dev_debug.log file to confirm that the auto-registration request has been received and is being processed by the Cisco StadiumVision Director auto-registration process. In the following a request from DMP 10.10.90.20 is being processed:

```
[guest@svd1 logs]# pwd
/opt/sv/servers/config/logs

[guest@svd1 logs]# egrep -i '10.10.99.20' sv_dev_debug.log | cut -c100-299
Received DMP auto register message from: 10.10.99.20 message: 00:0f:44:01:57:b7
SvLoggerFactory - Discovering DMP: 10.10.99.20
SvLoggerFactory - IP: '10.10.99.20', MAC: '00:0f:44:01:57:b7', Model: DMP-4310'
```

Step 10: Examine the sv_dev_debug.log file to confirm that provisioning process is stepping thru all the five major tasks. In the following the StageTemplate and GlobalMIB tasks for the DMP with MAC address 00-0f-44-01-57-b7 have been successfully completed:

```
[guest@svd1 logs]# pwd
/opt/sv/servers/config/logs

[guest@svd1 logs]# egrep -i 'AUTO' junk | egrep endpoint | cut -c104-299
CompositeCommand - AUTO-00-0f-44-01-57-b7 Doing (Wait for Notify) 3 of 5 steps of
workflow : ProvisionDMP
GenericDMPCommand - Device AUTO-00-0f-44-01-57-b7 is of type : DMP_C3PO
GenericDMPCommand - StageTemplate started on device: AUTO-00-0f-44-01-57-b7
GenericDMPCommand - AUTO-00-0f-44-01-57-b7) Start StageFlash Template
GenericDMPCommand - AUTO-00-0f-44-01-57-b7) Stage Flash template response: okay
GenericDMPCommand - AUTO-00-0f-44-01-57-b7) Flash Template staged successfully
GenericDMPCommand - StageTemplate succeeded on device: AUTO-00-0f-44-01-57-b7
CompositeCommand - AUTO-00-0f-44-01-57-b7 Doing (Wait for Notify) 4 of 5 steps of
workflow : ProvisionDMP
GenericDMPCommand - Device AUTO-00-0f-44-01-57-b7 is of type : DMP_C3PO
GenericDMPCommand - GlobalMIB started on device: AUTO-00-0f-44-01-57-b7
GenericDMPCommand - GlobalMIB succeeded on device: AUTO-00-0f-44-01-57-b7
CompositeCommand - AUTO-00-0f-44-01-57-b7 Doing (Wait for Notify) 4 of 5 steps of
workflow : ProvisionDMP
```

Step 11: The /opt/sv/servers/monitor/logs/sv_dmp_syslog.log file captures all the syslog messages sent by the DMP. The presence of even one syslog message is evidence that the DMP has successfully received the global DMP settings, as this is how the DMP learns the IP address of the syslog server (also Cisco StadiumVision Director). A good check point to look for in this log is where the DMP reports that it is loading the Cisco.InitTV app. This is the swf file that displays the auto-registration status banner on the TV:

```
[guest@svd1 logs]# pwd
/opt/sv/servers/monitor/logs

[guest@svd1 logs]# grep InitTV sv_dmp_syslog.log
2011-09-29 16:00:44,156 [SyslogMgr-ThreadPool] DEBUG svlog.dmp.syslog.log -
syslog_dmp_msg,Thu Sep 29 16:00:44 MDT 2011,10.10.99.20,<175> Dec 31 16:02:53
10.10.99.20 DMP-4310[961]{-1}(28)~00-0F-44-01-57-B7~1999~PST~no: ;sv.info;LOADING
APP: name = Cisco.InitTV, exec = apps/InitTV-1920x1080.swf, priority = 0
```

DMP POE Issue

With early versions of the DMP 4310G, there is an issue with the negotiation of the correct PoE wattage. The root cause is believed to be that the switch and the DMP-4310 fail to consistently negotiate the correct power class during the (optional)

power class negotiation. In some cases, the switch believes that the DMP can operate at a lower power class than the DMP actually requires, resulting in the DMP failing to complete boot up.

Correction of this problem required a hardware change. USI executed an engineering change to the DMP 4310G in response to this issue. DMP 4310Gs with serial numbers **USI1434xxxx** or greater have this engineering change and should not be subject to this issue. DMP 4310Gs with serial numbers less than **USI1434xxxx** may be subject to this issue, and should follow the suggested workaround.

The serial number is located on the back and can be verified through visual inspection. The serial number is also remotely accessible as a MIB parameter, and can be located in the management dashboard under MIB Variables in the Status tab. Affected DMP's can also be identified using the dashboard search option "Power over Ethernet DMP does not support PoE".

Workaround

The correct workaround depends on the Cisco switch platform that the DMP is connected is enhanced Power over Ethernet (ePoE) capable.

- ePoE Capable Platforms - If there is ample PoE power available in the switch's power budget, apply the **power inline static max 15401** interface-level command to each access switch port connected to a DMP-4310.

The use of "power inline static max 15401" command requires "power inline port max 15401" be configured first.

On an ePoE-capable switch platform, specifying a maximum power level greater than the 802.3af maximum of 15.4W has a side effect of causing the switch port to bypass the optional power class negotiation phase.

The use of the **static** keyword is suggested in order to reserve the required power from the switch's power budget at configuration time. If for some reason the switch's remaining power budget cannot accommodate the port's configured power requirement, the port is placed into error disable state at point of configuration, rather than point of need.

- Non-ePoE Capable Platforms – Because non-ePoE capable switch platforms cannot be configured to deliver more than the 802.3af maximum of 15.4W/port, the suggested workaround is to insert a PoE splitter between the switch port and the DMP 4310G. Generally, a PoE splitter is used to strip the PoE power from a PoE-capable switch port and provide it to a non-PoE capable device in lieu of its usual "power brick". In this case, the PoE splitter is used to circumvent the DMP 4310G PoE class negotiation issue, since the PoE splitter does not attempt to negotiate the PoE class with the switch and simply passes through the available power it receives over the cable run.

The following PoE 12V splitter has been test to operate correctly with the DMP-4310:

DMP HDMI Issue

DMP 4310G units with serial numbers below **USI1515xxxx** may exhibit a problem where no video signal is output on the HDMI port, resulting in a black screen. Everything else about the DMP appears to be normal.

Workaround

Powering of the DMP and allow it to cool for at least 10 minutes. Then turn it back on. If the problem persists then consider replacing the unit.

DMP Reboot Behaviour

If you reboot a DMP during an event script, expect the following behavior:

- If the event is not running or the event script does not control the DMP, you will be brought back to full screen video of defaultVideoUrl from the registry.
- If the DMP is controlled by the event script, then you should see the following behavior:
 - During the reboot, you will lose all video / templates / etc.
 - After the reboot has recovered, the DMP will take a few seconds to recover.
 - After recovery has completed, you should see the template from the script. (Full screen / 3 region / etc.), and the non-video playlists will be correct. However, if the current script state has a video region with no actions configured, then the video will be that of the defaultVideoURL. If the current state has a video region with "actions" then the DMP will play out the action described in that state after it receives the next state update multicast message.

DMP Recovery Behavior

If a DMP does not have connectivity when the state changes, it will only recover the correct template setting and show non-video playlists when the DMP network connectivity is restored. Thus, any other action (including video channel changing, RS-232 commands, Turn On / Turn Off) will not be performed once the DMP's connectivity is restored. If the network outage is brief, the actions may be performed, but this depends on the brevity of the connectivity loss. Delays greater than 30 seconds will not work, as there are cutoffs on how long StadiumVision Director will wait.

As a further variant, if a DMP is offline when the event script starts, and then is reconnected, it will not receive any state changes in the future until a new event is started. This is because the DMP will never receive the initial Reset command that tells it to re-read its event script information. Therefore, when the DMP is reconnected, it will not be aware of the new templates and non-video playlists.

Common Problems and Resolutions

| Symptom | Possible Cause | Action |
|---|--|--|
| Script running slow or not running at all on the DMP. | The DNS configuration on the DMP or StadiumVision Director is incorrect. | Verify that DNS is disabled on the DMP. Verify that the DNS server (if used) is configured correctly in StadiumVision Director and that the specified DNS server is reachable. If it is not reachable, disable DNS on StadiumVision Director until the DNS server is back online. |
| The Welcome screen in a luxury suite shows up on the wrong TV. | The TV is configured incorrectly in StadiumVision. | Determine the MAC address of the DMP either by looking at the DMP or by using the Menu button on the Cisco IR Remote to bring up the system info. Verify that this DM is mapped to the correct Location, and the Location assigned to the correct group. |
| In the luxury suite, the wrong TV shows the concessions menu items. | The configuration of the system was done incorrectly. | In the luxury suite configuration, the concessions menu is displayed on Display #1 (or more precisely, Suite DMP Logical ID #1) in a room. Display #1 is connected to the first DMP associated with that luxury suite. See the <i>StadiumVision Commerce Integration Design and Implementation Guide</i> for more information. |
| After pushing the script, the TV is not on. | The RS-232 cable may not be properly connected | Use the IR remote to turn on the TV. If you see a red LED flash but there is no response to the command, then it is likely that the RS-232 cable is plugged into the wrong port on the DMP. Move the connection to the RS-232 port on the DMP. |

| Symptom | Possible Cause | Action |
|--|--|--|
| The TV is dark. | <ul style="list-style-type: none"> • No power to the TV (no lights - either red or green). • TV not turned on. • TV set to wrong input. • DMP is not power on. • DMP is not configured in the system • DMP does not have an SV Daemon installed (DMP 4305G only) • DMP is tuned to a full-screen video channel which has no video • DMP has a content problem (e.g. it might be using a message template but the playlist is not loaded on the DMP). • There is a cabling issue with the cables connecting the DMP to the switch. • The SD card could be bad or missing. | <ul style="list-style-type: none"> • Assure that the TV is plugged in and that the outlet has power. • Turn on the TV. • Use the TV IR remote to verify the TV is on the correct input. • Ensure that the DMP has power (check if DMP LED lamps are lit and if not, make sure the DMP power switch is engaged (4310 only) or the switch port is configured). • Add the DMP to StadiumVision Director database. • Use DMP IR remote to power on TV. <ul style="list-style-type: none"> - If TV does not power on via DMP IR remote, check the RS-232 cable and port connections. - If TV does not power on via DMP IR remote, push the Template to the DMP and try again. - If TV still does not power on, check the RS-232 commands configured in StadiumVision Director. • Change the DMP channel (if necessary, change the DMP default channel or the failover URL). • Download appropriate content to the DMP using the StadiumVision Director Control Panel Setup tab. • Make sure the DMP is properly connected to the Ethernet switch and that the cables are good. • Verify that the SD card is present and properly seated. If nothing else has worked, try replacing the SD card. Assure that the DMP has a default URL set to a working channel, so that worst case is full screen video instead of a blank screen |
| Graphics are “cut off” or do not appear properly on the TV screen. | <ul style="list-style-type: none"> • The aspect ratio of the TV is not set correctly. • The incorrect template has been applied. | <ul style="list-style-type: none"> • Check the TV Aspect Ratio and Overscan settings. Set Aspect Ratio to Normal and Overscan off. • If the above TV settings are not available or do not fix the problem, adjust the X/Y Position or Scaling in Devices>DMP>Display Specs. • Ensure that the correct content template is being used for the attached DMP model. (1920x1080 for a DMP 4310G; 1366x768 for a DMP 4305G) |
| The TV shows a butterfly. | <ul style="list-style-type: none"> • The SV Daemon is not installed. • The SD card is missing, improperly seated, or bad (DMP 4305G only) • The DMP does not have the Flash template installed. • The DMP is not configured in the StadiumVision Director database. | <ul style="list-style-type: none"> • Install the SV Daemon. • Install a working SD card. Also, assure that a failover URL is set for this DMP: this will at least insure that in the absence of a working SD card, full screen video is displayed. • Install the Flash template. • Add the DMP to the StadiumVision Director database. |

| Symptom | Possible Cause | Action |
|---|--|--|
| When using the IP Phone, there is a delay when using the TV controls (volume, channel selection) and a delay in TV operation. | Either the switch port or the IP phone is not set to 100 Mbps and Full Duplex. | To set the phone to 100 Full , touch the Settings button. Select option 2, Network Configuration. Scroll down to SW Port Configuration. If SW Port Configuration says 100 Full , the problem is not with the phone settings. Touch exit until you return to the main screen. Then check and reset the switch port. If SW Port Configuration says anything other than 100 Full , touch “* * #” to unlock the configuration. Scroll down to 100 Full . Select 100 Full , save your change, and then touch the exit soft key until you are back to the main screen. Touch “* * #” again to lock the settings. If the problem does not go away, check and reset the switch port. |
| The channel changed automatically in a luxury suite. | a) There was a state change and the script action for this region did not specify ChannelNoChange as the action. b) A configuration error in StadiumVision defines a controller outside of this suite as the suite controller. | a) If this is not the desired action, go to the script for this or subsequent events and set the action to “No Change” for the channel on this TV. b) Correct the configuration so that only the controller in this suite has control over the DMPs in this suite. |
| The screen alternates between video and black every few seconds. | This is likely an HDMI handshake issue. The 4305 does not support the High-Bandwidth Digital Content Protection (HDCP) protocol (a proprietary protocol requiring licensing.) If the TV is powered up first, it will do a handshake, determine that the 4305 doesn't support HDCP, and not use it. If the DMP is powered up first, some displays will continually search for a copy protection stream. If they find it (which would happen with network broadcasts) it works fine. However, with some displays, when you run a non-copy-protected stream (in-house feeds) through the HDMI port, the TV gets out of sync with the signal because it is looking for the copy protection stream in the feed. | Power up the TV first, and then the DMP. If this problem persists with certain TVs, then disable DMP auto detection in the DMP Display Attributes. |
| The screen on one TV didn't change when the other screens changed during a state change. | No action was assigned for this DMP during this state. | Verify that this DMP is in a group that has an action assigned during this state. |

| Symptom | Possible Cause | Action |
|---|--|---|
| There is no video showing in Region 1. | <p>IP multicast settings are incorrect.</p> <p>DMP is tuned to a "blank" channel. This may be a desirable behavior in some situations.</p> | <ul style="list-style-type: none"> • Verify that the channel selected for Region 1 has a valid video feed associated. (Valid IP multicast address and port number configured at the headend.) • Try to ping the multicast group that the DMP should be listening on. This should be the group address specified in MulticastHostPort entry in the registry. The syntax is: ping -t 15 <MC_Address> Any DMPs that are listening to this multicast address will respond. If the DMP is not listening to this multicast address, verify that the settings are correct in the SVD.conf file. • If there is not a constant flashing LED on the DMP Ethernet port, check the multicast configuration at the IDF switch. |
| There is nothing in Region 2 of the L-wrapper for a group of displays (the region is either black or blue). | <ul style="list-style-type: none"> • No action was defined for this region during this state. • The DMP does not have the content it needs. • The playlist contains one or more images in an interlaced format. • The L-wrapper is incorrectly configured. • The content synchronization to the DMP failed. • A network problem or a Secure Digital (SD) failure. • The ticker is configured incorrectly. | <ul style="list-style-type: none"> • Assure that Region 2 of the L-wrapper for this group is defined during this state. • Push the content to the DMP again using the Setup tab in the StadiumVision Director control panel. • Assure that the image is of a supported type. No way to easily tell if the image is interlaced. Best to open in Photoshop and save it as non-interlaced format. • If the issue is with the L-wrapper: <ul style="list-style-type: none"> – Check for bad or missing RSS URL – Verify MC ACL is set to allow the RSS Stream – Verify RSS feed is Approved in Cisco StadiumVision Director – Verify RSS upload task is running on Cisco StadiumVision Director • If it is a network problem, try pushing the content to the DMP again. • If it is an SD failure, assure the SD card is securely seated in the DMP or replace the SD card. |
| Video playback is choppy. | Cat 5 cabling may be longer than 100 Meters specified. | Use a shorter cable. |
| DMPs do not seem to change states when the states change in StadiumVision Director | <p>The DMP may not be associated with the correct group.</p> <p>The Flash application may not be running.</p> <p>The MulticastHostPort is not set correctly.</p> | <p>Assure that the DMP is associated with the correct Group in StadiumVision Director.</p> <p>Confirm that the Flash application is running on the DMP.</p> <p>If the application is running, a circle, square and triangle should be displayed in the lower left hand corner of the screen when you start the event script. If you do not see these items, the flash application may not be running.</p> <p>Restart the Flash application using the Management Dashboard.</p> <p>Verify the MultiCastHostPort in the Cisco StadiumVision Director Registry is correct. If corrected, push the template again to propagate the setting to the DMP.</p> |

| Symptom | Possible Cause | Action |
|--|---|--|
| The TV does not have the correct screens for the current state. | The TV is in the wrong group for this state. | Correct the group setting using the StadiumVision Director control panel. |
| The delay has ended, but some TVs still have the delay content showing. | These DMPs may not have an action assigned for the state when the delay occurred. | Check the script for this event and make sure the DMPs have an action assigned for every state in the event. |
| Ticker is not interleaving as defined. | One ticker has more approved content than the other. | When one feed runs out of approved content, only the remaining feed will be displayed until it reaches the end. |
| The Ticker says "Undefined". The flash image motion is slow or the video quality is degraded. | There are no approved ticker items to display. Flash images may have too many frames per second. | Select the Ticker tab on the StadiumVision Director Control Panel. Either touch Approve All on the middle of the right hand side of the screen, or selectively approve the ticker items you want to display. Modify the flash images so that they have less than 5-6 frames per second. |
| Invalid RSS Ticker | There is a missing or invalid RSS URL. The Multicast ACL in the network is not configured to allow the RSS MC group. Upload task is not running | Check the URL via a browser to verify that it is valid and providing content. Check the ACL in the core switch of the Connected Stadium network |
| TV is frozen (video is not moving and /or region 2 /3 are not moving.) | | Hard boot the DMP (power off the DMP and then reboot.) |
| Jerky/pausing TV on when playing within an L-wrapper | Init.BCNT is set improperly. | Verify init.BCNT=40 |

Appendix A: DMP Connector Pin outs and Cable Schematic

DMP 4305 RS-232 pin outs

[Table 8](#) lists the DMP 4305G connector pin out assignments.



Table 8. 4305G DB9M RS-232 Pinout

| Function | Signal | Pin | I/O |
|-----------|---------------------------|-----|-----|
| Data | TxD (Transmit Data) | 3 | O |
| | RxD (Receive Data) | 2 | I |
| Handshake | RTS (Request to Send) | 7 | - |
| | CTS (Clear to Send) | 8 | - |
| | DSR (Data Set Ready) | 6 | - |
| | DCD (Data Carrier Detect) | 1 | - |
| | DTR (Data Terminal Ready) | 4 | - |
| Common | GND (Signal Ground) | 5 | - |
| Other | RI (Ring Indicator) | 9 | - |

DMP 4310 RS-232 pin outs

[Table 9](#) lists the DMP 4310G RS-232 cable DB9 pin out assignments.

Table 9. 4310G DB9F RS-232 Pinout

| Function | Signal | Pin | I/O |
|----------|---------------------|-----|-----|
| Data | TxD (Transmit Data) | 2 | O |
| | RxD (Receive Data) | 3 | I |
| Common | GND (Signal Ground) | 5 | - |

Figure 66. 4310G RS-232 Cable Schematic

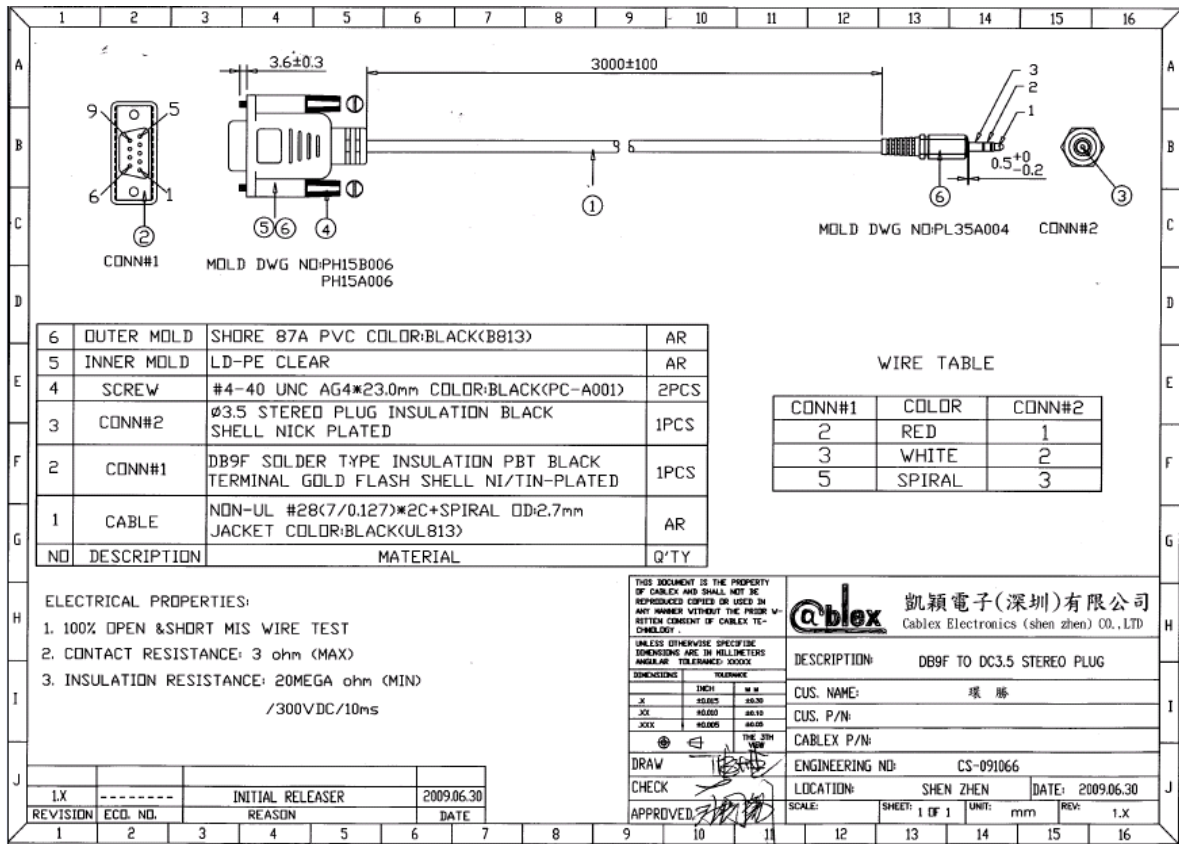

DMP 4310 S-Video DIN to Component pin outs

The DMP 4310 requires a custom cable when used for composite or component video. The pin outs for this cable are documented below. At the time of publication, the adapter cables were available to be ordered from Computer Discount Warehouse (CDW). Contact details are available at cdw.com. The CDW part number is:

Part #: CDW-NEW-ITEM /Tripplite Custom C001-06N-A TRIPP

Description: 6IN 7PIN MALE S-VIDEO 3X RCA F

Note that these cables are custom-made items from CDW and not normally kept in stock. Expect lead times of at least 4-6 weeks after ordering.

Table 1. DMP 4310 S-Video DIN to Component pin outs

| Pin | Function |
|-----|----------|
| 1 | Ground |
| 2 | Ground |

| | |
|---|--|
| 3 | Luma (Y), Horizontal sync, Vertical sync |
| 4 | Pr (R - Y) |
| 5 | Pb (B - Y) |
| 6 | Ground |
| 7 | N/C |

When the DMP is configured for Composite the video signal is output on pin 5.

Figure 67. DMP 4310 S-Video DIN to Component cable schematic

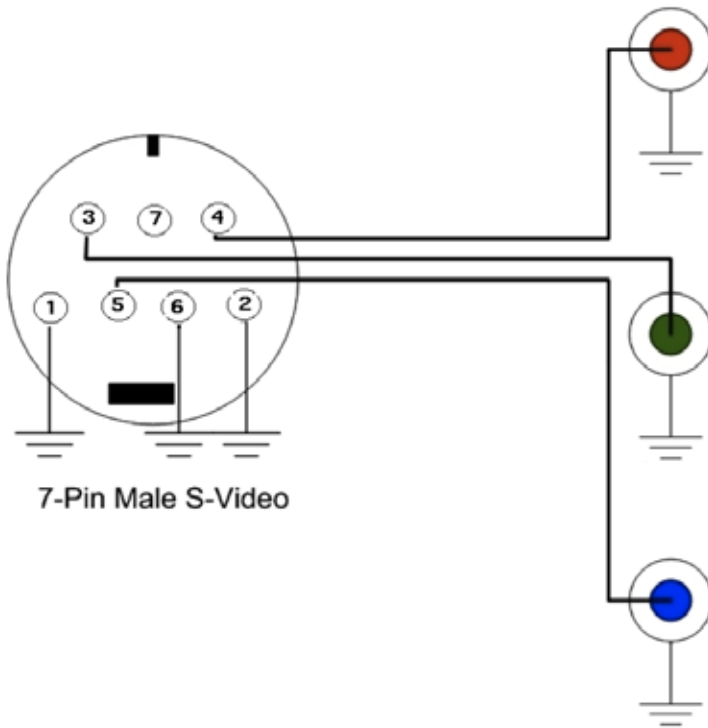

Appendix B: Determining the RS-232 Command Strings

Below is an example of how to determine the commands for controlling a particular TV (i.e. LG in this example).

- 1 Use the TV User Manual to find the RS-232 code for a desired function. For example, Power On
- 2 Typically the TV RS-232 code is described in ASCII and will require the conversion to Hex to be used in the DMP to control the TV (e.g., TV code = ka 01 01[CR=0D])

1 From TV User Manual

01. Power (Command: k a)

To control Power On/Off of the TV.

Transmission [k][a][][Set ID][][Data][Cr]

Data 00: Power Off Data 01: Power On

Transmission / Receiving Protocol

Transmission

[Command1][Command2][][Set ID][][Data][Cr]

[Command 1] : First command to control the set.(j, k, m or x)

[Command 2] : Second command to control the set.

[Set ID] : You can adjust the set ID to choose desired TV ID number in Setup menu. Adjustment range is 1~ 99. When selecting Set ID '0', every connected the TV is controlled. Set ID is indicated as decimal (1~ 99) on menu and as Hexa decimal (0x0~0x63) on transmission /receiving protocol.

[DATA] : To transmit the command data.
Transmit the 'FF' data to read status of command.

[Cr] : Carriage Return
ASCII code '0x0D'

[] : ASCII code 'space (0x20)'

* In this model, TV will not send the status during the standby mode.

© 2006 Cisco Systems, Inc. All rights reserved.

Cisco Confidential

2 Hex To ASCII Converter

Hex:

6b:61:20:30:31:20:30:31

Ascii:

ka 01 01

Hex To ASCII

ASCII To Hex



RS-232 Code Configured in SV Director
rs232.tx_hex=6B612030312030310D

Reference the TV Specifications document on the Share Point for a collection of RS-232 codes