



# Cisco UCS Fabric Interconnect 9108 100G



CISCO SYSTEMS  
170 WEST TASMAN DR.  
SAN JOSE, CA, 95134  
[WWW.CISCO.COM](http://WWW.CISCO.COM)

PUBLICATION HISTORY  
REV A.02, MAY 03 2024

---

# CONTENTS

- OVERVIEW . . . . . 3**
- DETAILED VIEWS . . . . . 4**
  - UCS Fabric Interconnect 9108 100G . . . . . 4
- Detailed View . . . . . 5**
- LED Indicators . . . . . 7**
- Capabilities and Features . . . . . 8**
- SUPPORTED FEATURES AND CONFIGURATIONS . . . . . 11**
- CONFIGURING the FABRIC INTERCONNECT . . . . . 12**
  - STEP 1 SELECT FABRIC INTERCONNECTS . . . . . 13
  - STEP 2 SOFTWARE LICENSE (INCLUDED) . . . . . 14
  - STEP 3 CHOOSE TRANSCEIVERS AND CABLES (OPTIONAL) . . . . . 15
- SUPPLEMENTAL MATERIAL . . . . . 18**
  - Cisco UCS X-Series Direct Connectivity . . . . . 18
  - Connectivity Between M6/M7 Compute Node and UCS Fabric Interconnect 9108 100G . . . . . 22
- TECHNICAL SPECIFICATIONS . . . . . 25**
  - Physical Dimensions and Specifications . . . . . 25
  - Compliance Specifications . . . . . 26
  - System Requirements . . . . . 27

## OVERVIEW

Cisco UCS X-Series Direct transforms the Cisco UCS X-Series Modular System into a self-contained system with pair of internal Cisco UCS Fabric Interconnects 9108 100G that integrate each of up to eight server nodes with Cisco unified fabric connectivity, upstream IP and Fibre Channel connectivity, all managed through Cisco Intersight or the time-proven Cisco UCS Manager.

The platform supports two- and four-socket compute nodes of which up to eight and four (respectively) can populate a chassis. Each node can support up to six NVMe drives, two M.2 drives, two VICs, and up to six GPU accelerators. The platform's capabilities can be extended through the Cisco UCS X-Fabric.

The fabric interconnects create a self-contained system connecting IP, storage, and management networks with two 100-Gbps connections to each of eight slots in the chassis. Within each compute node, Cisco virtual interface cards provide the number and type of I/O devices that you create depending on your application.

The fabric interconnects connect upstream to switches or storage appliances with eight 100- Gbps ports that can carry 1, 10, 25, 40, and 100 Gigabit Ethernet to upstream switches. In the future, these ports can be used to connect to a second Cisco UCS X9508 chassis equipped with intelligent fabric modules, with the primary chassis serving as a single point of connectivity and management for the edge location. The Fabric Interconnect can also provide eight Fibre Channel uplink or storage ports (8-, 16- or 32-Gbps FC) that can connect directly to a FC SAN switch (Cisco MDS or non-Cisco) or an FC storage array.

The Cisco UCS X-Series Direct is designed to shift your thinking from administrative details to business outcomes-with infrastructure that is assembled from the cloud, shaped to your workloads, and continuously optimized. Now that hardware can think and change like software, you are free to think like tomorrow. This brings about immense simplification to edge applications:

- **Simplify with cloud-operated infrastructure:** By shaping system resources to workload requirements with Cisco Intersight, you can deliver intelligent visualization, optimization, and orchestration to all your applications and infrastructure.
- **Simplify with an adaptable platform:** Edge applications have widely varying requirements. At the edge, you can use a single platform that combines the density and efficiency of blade servers with the expandability of rack servers for better performance, automation, and efficiency.
- **Simplify with a system engineered for the future:** Embrace emerging technology and reduce risk with a modular system engineered to support future generations of processor, accelerator, and interconnects with management enabled by a constant stream of new capabilities delivered as Software-as-a-Service (SaaS).

## DETAILED VIEWS

### UCS Fabric Interconnect 9108 100G

The Cisco UCS Fabric Interconnect 9108 100G (*Figure 1*) is an integrated 1/10/25/40/100 Gigabit Ethernet, FCoE, and Fibre Channel switch offering up to 1.6 Tbps throughput and up to 8 ports. The switch has 6 40/100-Gbps Ethernet ports and 2 unified ports that can support 40/100-Gbps Ethernet ports or 8 Fiber Channel ports after break-out at 8/16/32-Gbps FC speeds. The 8 FC ports after breakout can either operate as an FC uplink port or as an FC storage port. The switch supports 2 1-Gbps speed after breakout and all 8 ports can breakout for 10/25-Gbps Ethernet connectivity. All Ethernet ports are capable of supporting FCoE. Beyond the 8 external facing 100G ports, the Fabric Interconnect 9108 100G also provides eight 100G or thirty-two 25G backplane ethernet ports connectivity towards the X-series compute nodes depending on 100G or 25G VIC. The rear-view image shows the ortho-direct connectors that will connect to the VIC on the X-series compute node.

The Cisco UCS Fabric Interconnect 9108 100G also has one network management port, one console port for setting the initial configuration, and one USB port for saving or loading configurations.

*Figure 1* shows the 8-port FI.

**Figure 1** Cisco UCS Fabric Interconnect 9108 100G.

Front View



Rear View



## Detailed View

The Cisco UCS Fabric Interconnect 9108 100G front view shown in [Figure 2](#).

**Figure 2** Cisco UCS Fabric Interconnect 9108 100G (front view)

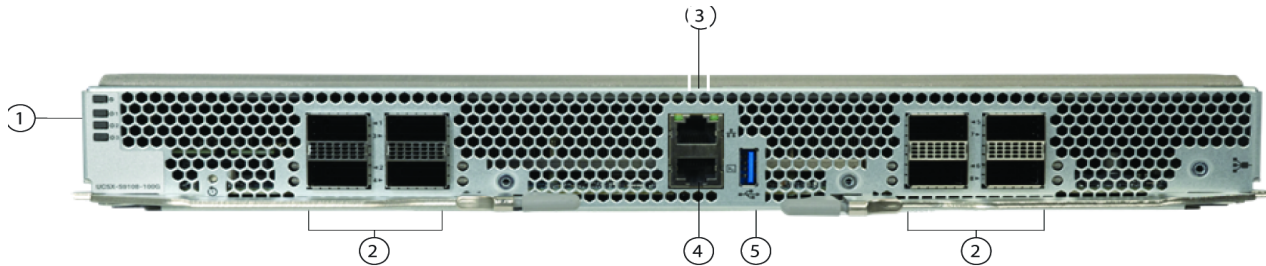

1	<b>Status LEDs:</b> <ul style="list-style-type: none"> <li>■ FI Status (top LED)</li> <li>■ Fan Status LEDs 1 through 3, with Fan 1 as LED 2, Fan 2 as LED 3, and Fan 3 as LED 4.</li> </ul>	2	<b>QSFP28 Optical Ports.</b> Ports are arranged in two groups of four physical ports. Ports are stacked in vertical pairs, with two ports in each vertical port stack.
3	Management Port	4	Console Port
5	USB Port	-	

[Figure 3](#) shows the FI top view characteristics.

Figure 3 Cisco UCS Fabric Interconnect 9108 100G (top view)

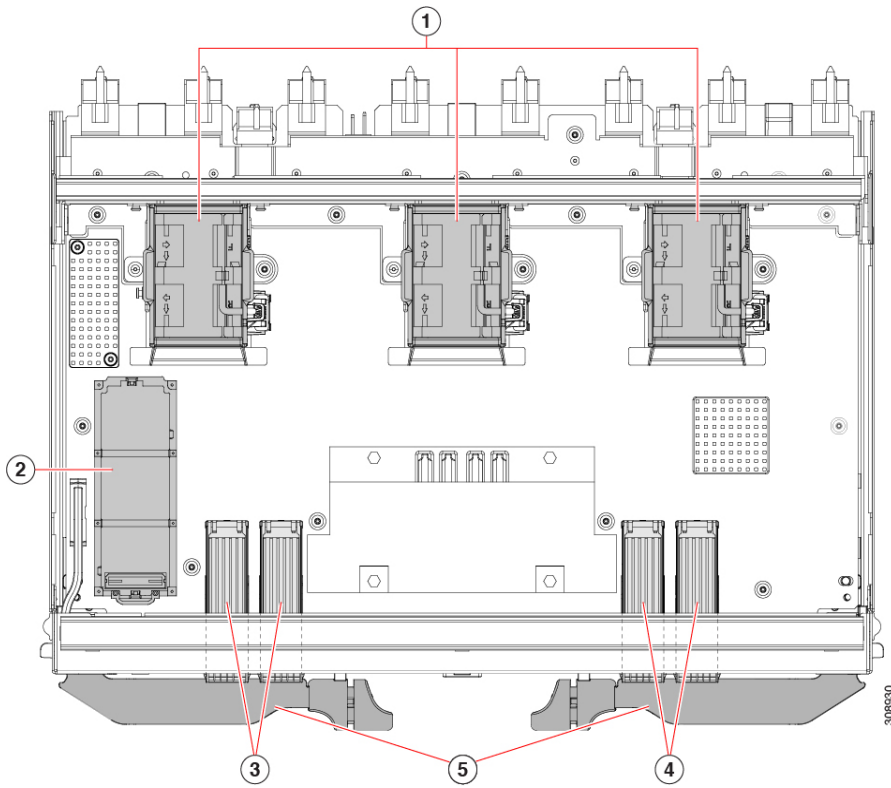

1	Fans (3) which are numbered 1 through 3 starting with the left fan	4	QSFP28 Optical Ports 5-8 Ports are arranged in two groups of four physical ports. Ports are stacked in vertical pairs, with two ports in each vertical port stack.
2	One M.2 mini storage module slot	5	FI ejector handles, left and right
3	QSFP28 Optical Ports 1-4 Ports are arranged in two groups of four physical ports. Ports are stacked in vertical pairs, with two ports in each vertical port stack.	-	-

## LED Indicators

The LED indicators are described in [Table 1](#) (see [Figure 2 on page 5](#) for LED locations)

**Table 1** FI LED States

LED	State	Description
FI Status	OFF	Power OFF
	GREEN	Normal Operation
	AMBER	Booting or minor Temperature Alarm
	BLINKING AMBER	Stopped in uboot or unable to come online, or major temperature alarm
FAN status LED # 1, 2, 3	OFF	Power OFF
	GREEN	Normal Operation
	AMBER	Fan fault (low fan speed or fan not running)
QSFP Port LED status 1 LED per port per color	OFF	Link enabled but not connected
	GREEN	Link connected
	AMBER	Operator disabled
	BLINKING AMBER	Disabled due to error

## Capabilities and Features

Network connectivity is provided by a pair of Cisco UCS Fabric Interconnect 9108 100G (FIs). These modules carry all network traffic to the Top-of-Rack (ToR) switches. Having a single point of network connectivity and control in a system provides deterministic low latency. This, in turn, frees you to place workloads without regard to whether the compute nodes are in the same chassis. Each FI features the following:

UCS Fabric Interconnect 9108 100G:

- Server ports: Up to 200 Gbps of unified fabric connectivity per compute node with two FIs.
- Uplink ports: 8x 100-Gbps QSFP28 ports.

The unified fabric carries management, production, and Fibre Channel over Ethernet (FCoE) traffic to the fabric interconnects. There, management traffic connects to the Cisco Intersight cloud operations platform; FC traffic is passed to native Fibre Channel interfaces through unified ports on the fabric interconnects, and production Ethernet traffic is passed upstream to the data center network.

Up to two Fabric Interconnect (FIs) 9108 100G plug into the back of the UCS X9508 chassis.

The Fabric Interconnect 9108 100G monitors and manages chassis components such as fan units, power supplies, environmental data, LED status panel, and other chassis resources. The compute node's Keyboard-Video-Mouse (KVM) data, Serial over LAN (SoL) data, and Intelligent Platform Management Interface (IPMI) data also travel to the FIs for monitoring and management purposes. In order to provide redundancy and failover, the FIs are always used in pairs.

There are 8x QSFP28 connectors on a FI to interface with the ToR switch. The FI provides up to 8x 100 Gbit/s links for the UCS Fabric Interconnect 9108 100G. The links provide the end-to-end interface from a compute node in the X9508 X-Series chassis to the connections on a ToR switch. When a compute node is inserted into the chassis, the compute node's upper mezzanine card (mLOM) plugs directly into the two FIs using two orthogonal connectors (ODs). The X9508 X-Series chassis accommodates two Cisco UCS Fabric Interconnects 9108 100G.

[Table 2](#) lists the capabilities and features of the Cisco UCS Fabric Interconnect 9108 100G.

**Table 2 Capabilities and Features**

Capability/Feature	Description
Server data path bandwidth	1.6 Tbps for 8 compute nodes (1x 100 Gbps or 4x25 Gbps per compute-node per UCSX-S9108-100G, for a total of 200 Gbps per compute node with dual UCSX-S9108-100G per X9508 Chassis)
Network data path bandwidth	1.6Tbps 8x 100Gbps per UCSX-S9108-100G, with two FI per chassis.
CPU complex	<ul style="list-style-type: none"> <li>■ Intel® Denverton Processor (8 core, 2.2GHz, 15W)</li> <li>■ DDR4 memory: 16GB max @ 2133 MHz</li> </ul>



Table 2 Capabilities and Features (continued)

Capability/Feature	Description
Fans	<p>The FI 9108 100G has three dual-rotor on board fans. The air flow direction is aligned with chassis air flow direction, which is front to rear.</p> <p>The FI 9108 100G Fans have minimum RPM requirements to be compatible with the chassis/system main fans. The fans are powered from 54VDC/48VDC. Fan speed is controlled and monitored by the FI CPU using a fan controller IC.</p>
Fibre Channel	FC + FCoE
Unified Ports	2 (1-2)
Power Supply	Power supplied by chassis
Power consumption	237W
Management	<ul style="list-style-type: none"> <li>■ Cisco Intersight software (SaaS, Virtual Appliance and Private Virtual Appliance)</li> <li>■ UCS Manager (UCSM) 4.3(4c) or later</li> </ul>
Unified Fabric	<ul style="list-style-type: none"> <li>■ Decreases total cost of ownership (TCO) by reducing the number of NICs, HBAs, switches, and cables needed</li> <li>■ Support Fibre Channel and Ethernet traffic concurrently in a Unified Fabric</li> <li>■ Increases flexibility with a range of interconnect solutions, including copper Twinax cable for short runs and fiber for long runs</li> <li>■ Consumes less power per port than traditional solution</li> </ul>
QSFP28-compatible ports	<p>Allows all ports to be configured to operate in 40/100 Gigabit Ethernet mode with the transceiver options specified for use with</p> <ul style="list-style-type: none"> <li>■ QSFP28-compatible ports</li> </ul>
Transceivers	<p>The Cisco UCS Fabric Interconnect 9108 100G supports a wide variety of 1/10/25/40/100 Gigabit Ethernet connectivity options using Cisco 1/10/25/40/100 Gbps modules. Unified Ports (UP) on the Cisco UCS Fabric Interconnect 9108 100G supports 10/25/40G/100G Gigabit Ethernet connectivity or a 128G FC-QSFP28 which can breakout into four 8/16/32 Gigabit Fibre Channel connection. Cisco UCS Fabric Interconnect 9108 100G provides flexible uplink port connectivity at 1G/10G/25G/40G/100G via Gigabit Ethernet transceivers and cables. Table 3 lists the supported transceiver options.</p>
Performance	<ul style="list-style-type: none"> <li>■ Provides high-speed, low-latency connectivity to the Cisco UCS X-Series chassis</li> <li>■ Provides approximately 50% reduction in end-to-end system latency (latency is less than 1 microseconds)</li> </ul>
Lossless Fabric	<ul style="list-style-type: none"> <li>■ Provides a reliable, robust foundation for unifying LAN and SAN traffic on a single transport</li> </ul>

**Table 2 Capabilities and Features** *(continued)*

Capability/Feature	Description
Priority Flow Control (PFC)	<ul style="list-style-type: none"><li>■ Simplifies management of multiple traffic flows over a single network link</li><li>■ Supports different classes of service, helping enable both lossless and classic Ethernet on the same fabric</li></ul>
Systemwide Bandwidth Management	Helps enable consistent and coherent quality of service (QoS) throughout the system

## SUPPORTED FEATURES AND CONFIGURATIONS

**Table 3** lists the supported features and configurations of the Cisco UCS Fabric Interconnect 9108 100G with the Cisco UCS X-Series Direct.

**Table 3 Supported Features and Configurations**

Capability/Feature	Description
Compute Nodes	The UCS X-Series Direct supports the X210c M6, X210c M7 and X410c M7 compute nodes
PCIe Node	The UCS X-Series Direct supports the X440p PCIe node as well as the UCS 9416 X-Fabric modules
Port Usage	The UCS Fabric Interconnect 9108 100G has eight QSFP ports. The eight QSFP ports can be configured as: <ul style="list-style-type: none"> <li>■ Uplink ports</li> <li>■ Appliance ports</li> <li>■ 1, 10, 25, 40, 100 Gbit ports</li> <li>■ 8/16/32 FC ports (FC end-host and FC switch mode)</li> <li>■ FCoE ports</li> </ul>
Number of UCS X-Series Chassis	Only one UCS X-Series chassis is supported.
Licensing	All QSFP ports are enabled by default and included in the perpetual license UCSX-S9108-SW.
Cisco UCS Fabric Interconnect 9108 100G	Two Cisco UCS Fabric Interconnect 9108 100G are required for production operation in the UCS X-Series chassis.

## CONFIGURING the FABRIC INTERCONNECT

Follow these steps to configure the Fabric Interconnect 9108 100G:

- *STEP 1 SELECT FABRIC INTERCONNECTS, page 13*
- *STEP 2 SOFTWARE LICENSE (INCLUDED), page 14*
- *STEP 3 CHOOSE TRANSCEIVERS AND CABLES (OPTIONAL), page 15*
- *SUPPLEMENTAL MATERIAL on page 18*

## STEP 1 SELECT FABRIC INTERCONNECTS

### Choose Fabric Interconnect

The available Fabric Interconnects are listed in [Table 4](#). Each FI connects to external ToR using 8x 100G ports

**Table 4 Available Fabric Interconnect**

Product ID (PID)	Description
Under UCSX-M6-MLB	
UCSX-S9108-100GM6	UCS X-Series Direct Fabric Interconnect 9108 100G
Under UCSX-M7-MLB	
UCSX-S9108-100G	UCS X-Series Direct Fabric Interconnect 9108 100G

The base Cisco UCS Fabric Interconnect 9108 100G does not include the following components. They must be selected during product ordering:

- Transceivers
- Cables
- Warranty Service as part of the overall Cisco UCS X-Series Direct



**NOTE:** Use the steps on the following pages to configure the FI with the components that you want to include.

## STEP 2 SOFTWARE LICENSE (INCLUDED)

*Table 5* shows the Software License Options. This included as a default line item under FI ordering PID.

Table 5 Software License

Product ID (PID)	Description
<b>Software License</b>	
UCSX-S9108-SW	Perpetual software license for the Cisco UCS Fabric Interconnect 9108 100G. This license activates all the ports and software features of the Cisco UCS Fabric Interconnect 9108 100G

### STEP 3 CHOOSE TRANSCEIVERS AND CABLES (OPTIONAL)

The Cisco UCS Fabric Interconnect 9108 100G supports a wide variety of 1/10/25/40/100 Gigabit Ethernet connectivity options using Cisco 1/10/25/40/100 Gbps modules. Unified ports (UP) on the Cisco UCS Fabric Interconnect 9108 100G support 10/25/40/100 Gigabit Ethernet connectivity or 8/16/32 Gigabit Fibre Channel modules.

The supported transceivers are for the UCS Fabric Interconnect 9108 100G is listed in [Table 6](#)

**Table 6 UCS Fabric Interconnect 9108 100G Supported Transceivers**

Product ID (PID)	Description
<b>QSFP28 100G Transceivers</b>	
QSFP-100G-SR4-S	100GBASE SR4 QSFP Transceiver, MPO, 100m over OM4 MMF
QSFP-100G-LR4-S	100GBASE LR4 QSFP Transceiver, LC, 10km over SMF
QSFP-40/100-SRBD	100GBASE/40GBASE SR-BiDi QSFP Transceiver, LC, 100m over OM4 MMF
QSFP-100G-SM-SR	100GBASE CWDM4 Lite QSFP Transceiver, 2km over SMF, 10-60C
QSFP-100G-SL4	100GBASE SL4 for up to 30M over OM4 MMF
QSFP-100G-DR-S	100G QSFP28 Transceiver 100GBASE-DR, 500m SMF, duplex, LC
QSFP-100G-FR-S	100G QSFP28 Transceiver 100G-FR, 2km SMF, duplex, LC
<b>QSFP28 100G Cables with Integrated Transceivers</b>	
QSFP-100G-CU1M	100GBASE-CR4 Passive Copper Cable, 1m
QSFP-100G-CU2M	100GBASE-CR4 Passive Copper Cable, 2m
QSFP-100G-CU3M	100GBASE-CR4 Passive Copper Cable, 3m
QSFP-100G-CU5M	100GBASE-CR4 Passive Copper Cable, 5m
QSFP-100G-AOC1M	100GBASE QSFP Active Optical Cable, 1m
QSFP-100G-AOC2M	100GBASE QSFP Active Optical Cable, 2m
QSFP-100G-AOC3M	100GBASE QSFP Active Optical Cable, 3m
QSFP-100G-AOC5M	100GBASE QSFP Active Optical Cable, 5m
QSFP-100G-AOC7M	100GBASE QSFP Active Optical Cable, 7m
QSFP-100G-AOC10M	100GBASE QSFP Active Optical Cable, 10m
QSFP-100G-AOC15M	100GBASE QSFP Active Optical Cable, 15m
QSFP-100G-AOC20M	100GBASE QSFP Active Optical Cable, 20m
QSFP-100G-AOC25M	100GBASE QSFP Active Optical Cable, 25m
QSFP-100G-AOC30M	100GBASE QSFP Active Optical Cable, 30m

Table 6 UCS Fabric Interconnect 9108 100G Supported Transceivers (*continued*)

Product ID (PID)	Description
<b>QSFP28 40G Transceivers</b>	
QSFP-40G-SR4	40GBASE-SR4 QSFP Transceiver Module with MPO Connector
QSFP-40G-SR4-S	40GBASE-SR4 QSFP Transceiver Module, MPO Conn, Enterprise-Class
QSFP-40G-CSR4	QSFP 4x10GBASE-SR Transceiver Module, MPO, 300M
QSFP-40G-SR-BD	40GBASE-SR-BiDi, duplex MMF (LC)
<b>QSFP28 100G Breakout Cables with Integrated Transceivers</b>	
QSFP-4SFP25G-CU1M	100GBASE QSFP to 4xSFP25G passive copper splitter cable, 1M
QSFP-4SFP25G-CU2M	100GBASE QSFP to 4xSFP25G passive copper splitter cable, 2M
QSFP-4SFP25G-CU3M	100GBASE QSFP to 4xSFP25G passive copper splitter cable, 3M
QSFP-4SFP25G-CU5M	100GBASE QSFP to 4xSFP25G passive copper splitter cable, 5M
QSFP-4SFP10G-CU3M	QSFP to 4xSFP10G Passive Copper Splitter Cable, 3m
QSFP-4SFP10G-CU5M	QSFP to 4xSFP10G Passive Copper Splitter Cable, 5m
QSFP-4SFP10G-CU10M	QSFP to 4xSFP10G Passive Copper Splitter Cable, 10m
QSFP-4X10G-AOC3M	40GBASE Active Optical QSFP to 4SFP breakout Cable, 3m
QSFP-4X10G-AOC5M	40GBASE Active Optical QSFP to 4SFP breakout Cable, 5m
QSFP-4X10G-AOC7M	40GBASE Active Optical QSFP to 4SFP breakout Cable, 10m
<b>SFP28 25G Cables with Integrated Transceivers</b>	
SFP-25G-SR-S	25GBASE-SR SFP Module
SFP-10/25G-LR-S	10/25GBASE-LR SFP28 Module
SFP-10/25G-CSR-S	Dual Rate 10/25GBASE-CSR SFP Module
SFP-25G-SL	25GBASE-SR SFP SL Module
SFP-10G-SR	10GBASE-SR SFP Module
SFP-10G-SR-S	10GBASE-SR SFP Module, Enterprise-Class
SFP-10G-LR	10GBASE-LR SFP Module
SFP-10G-LR-S	10GBASE-LR SFP Module, Enterprise-Class
CVR-QSFP28-SFP25G	100G to SFP25G adapter
CVR-QSFP-SFP10G	QSFP 40G to SFP+ 10G adapter
CVR-QSFP-SFP10G + GLC-T	100m
DS-SFP-4X32G-SW	4X 32G Optic SFP+



**NOTE:**

- The Fabric Interconnect 9108 100G supports 1G optics on ports 7 and 8.
  - Transceiver modules and cables that are supported on a specific fabric interconnect are not always supported on all VIC adapters, I/O modules, or fabric extenders that are compatible with that fabric interconnect. Detailed compatibility matrices for the transceiver modules are available here: <https://www.cisco.com/c/en/us/support/interfaces-modules/transceiver-modules/products-device-support-tables-list.html>
  - SFP-10/25G-LR-S and SFP-10/25G-CSR-S are supported only at 25G speed.
  - S-class transceivers do not support FCoE at 10G and 40G speeds.
- 

**Caveats**

---

- The maximum length of fiber optic runs is limited to 300 meters. This is imposed by our use of 802.3X/802.1Qbb Priority Pauses.
- 

**NOTE:** For transceiver specifications, see the following link:

[http://www.cisco.com/c/en/us/td/docs/interfaces\\_modules/transceiver\\_modules/compatibility/matrix/GE\\_Tx\\_Matrix.html](http://www.cisco.com/c/en/us/td/docs/interfaces_modules/transceiver_modules/compatibility/matrix/GE_Tx_Matrix.html)

---

- You should order enough transceivers and cables to accommodate your maximum foreseeable needs.
- In order to work with DS-SFP-4x32G-SW you need to have Multimode OM4 fiber, MTP/MPO female to 4x LC 8-fiber type-b breakout cable and 8/16/32G FC SW SFP

# SUPPLEMENTAL MATERIAL

## Cisco UCS X-Series Direct Connectivity

The LAN connectivity from the Cisco UCS Fabric Interconnect 9108 100G to the ToR switch is shown in [Figure 4](#) and [Figure 5](#)

Figure 4 LAN Connectivity with Cisco UCS Fabric Interconnect 9108 100G and vPC in End-Host mode

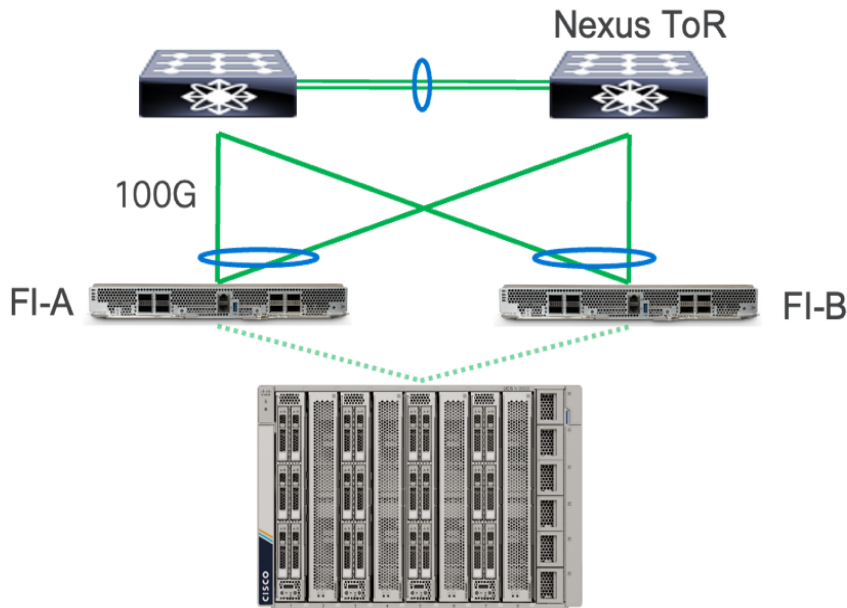
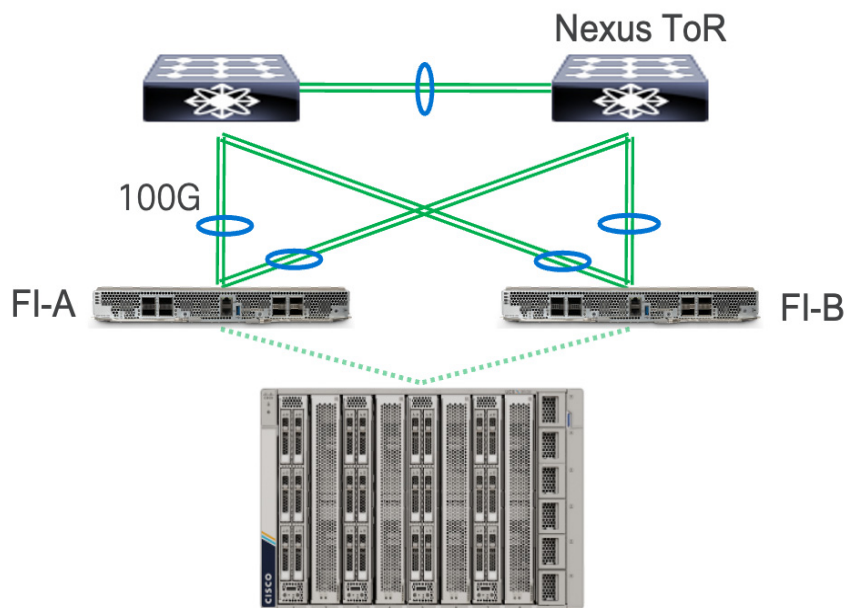
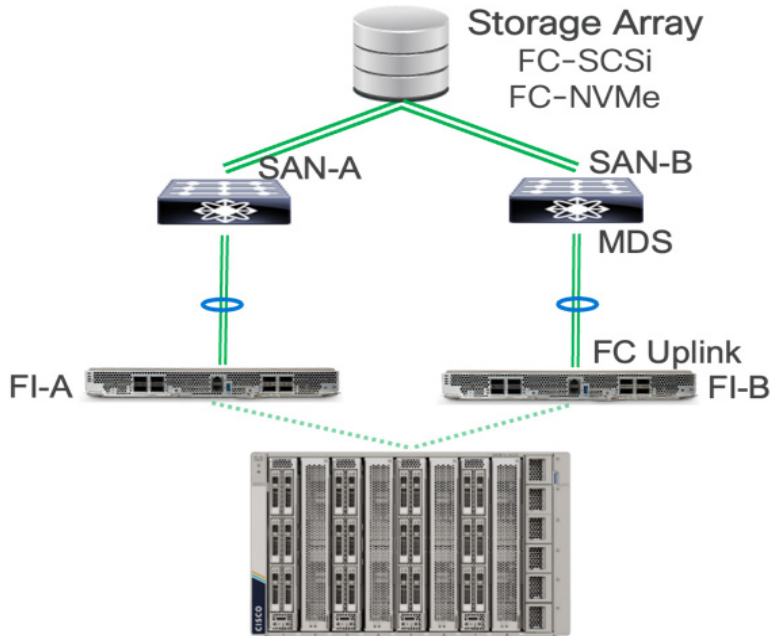

Figure 5 LAN Connectivity with Cisco UCS Fabric Interconnect 9108 100G but without vPC in end-host mode



The SAN connectivity from the Cisco UCS Fabric Interconnect 9108 100G to a Cisco MDS or non-MDS switch is shown in [Figure 6](#), [Figure 7](#) and [Figure 8](#)

**Figure 6** SAN Connectivity with Cisco UCS Fabric Interconnect 9108 100G and FC end-host or switch mode (Cisco MDS)



**Figure 7** SAN Connectivity with Cisco UCS Fabric Interconnect 9108 100G and FC end-host mode (non-Cisco MDS)

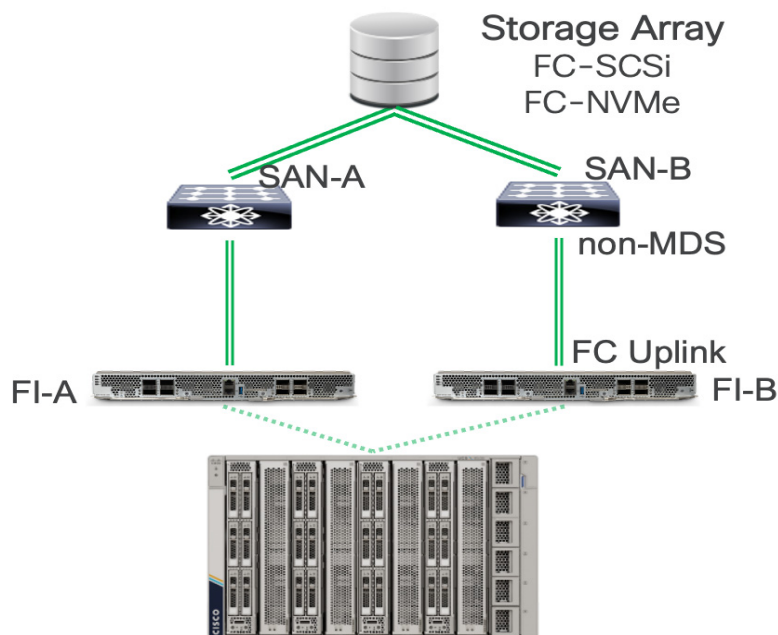
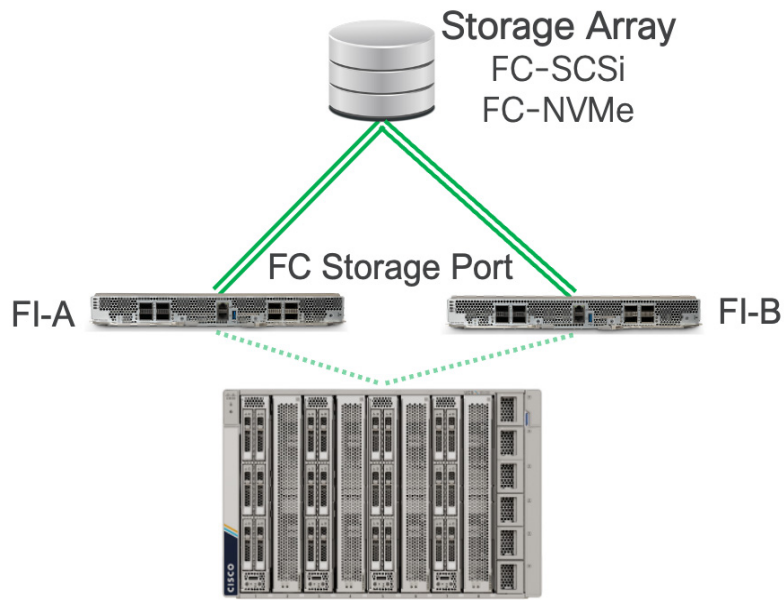
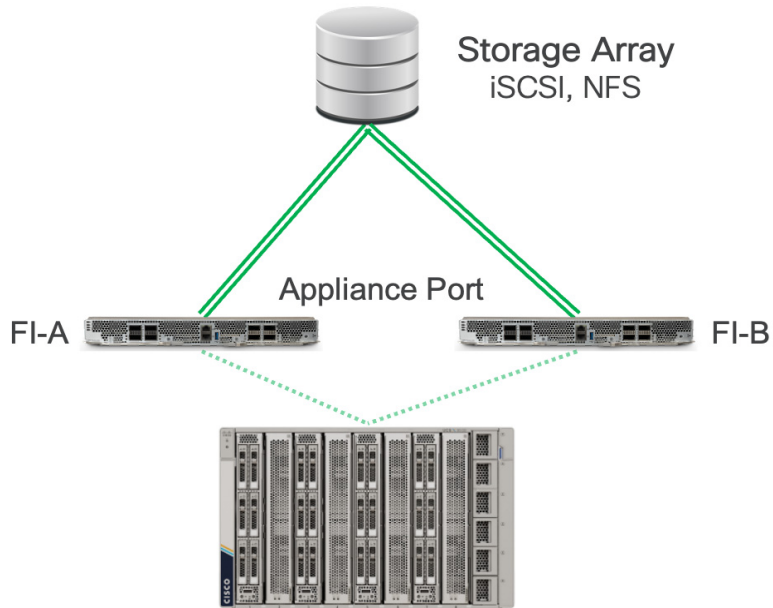

Figure 8 SAN Connectivity with Cisco UCS Fabric Interconnect 9108 100G and FC switch mode (direct attached)



The IP-SAN connectivity from the Cisco UCS Fabric Interconnect 9108 100G is shown in, [Figure 9](#) and [Figure 10](#)

**Figure 9** IP-SAN Connectivity with Cisco UCS Fabric Interconnect 9108 100G



**Figure 10** IP-SAN Connectivity with Cisco UCS Fabric Interconnect 9108 100G and Appliance Port through ToRs in vPC Port Channel configuration

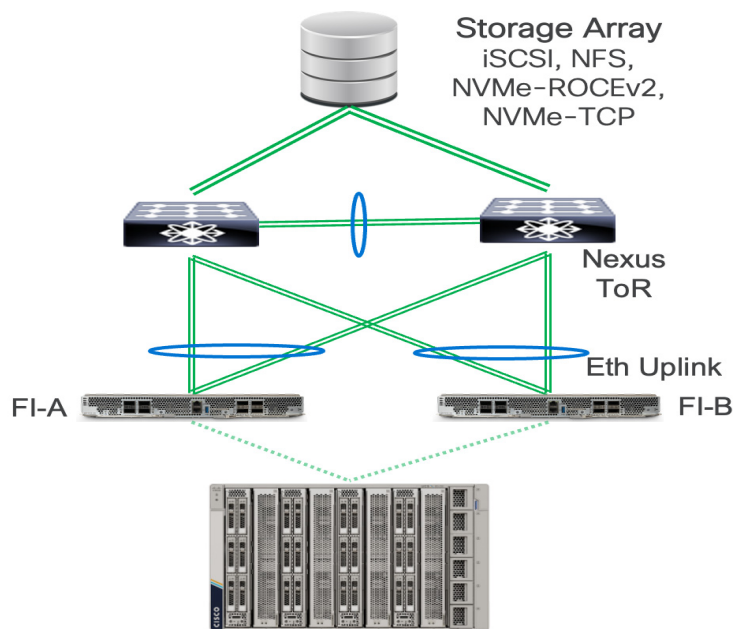

## Connectivity Between M6/M7 Compute Node and UCS Fabric Interconnect 9108 100G

Figure 11 and Figure 12 shows the network connectivity from the 25G mLOM out to the Cisco UCS Fabric Interconnect 9108 100G.

Figure 11 Dual-VIC Network Connectivity mLOM 25G to FI

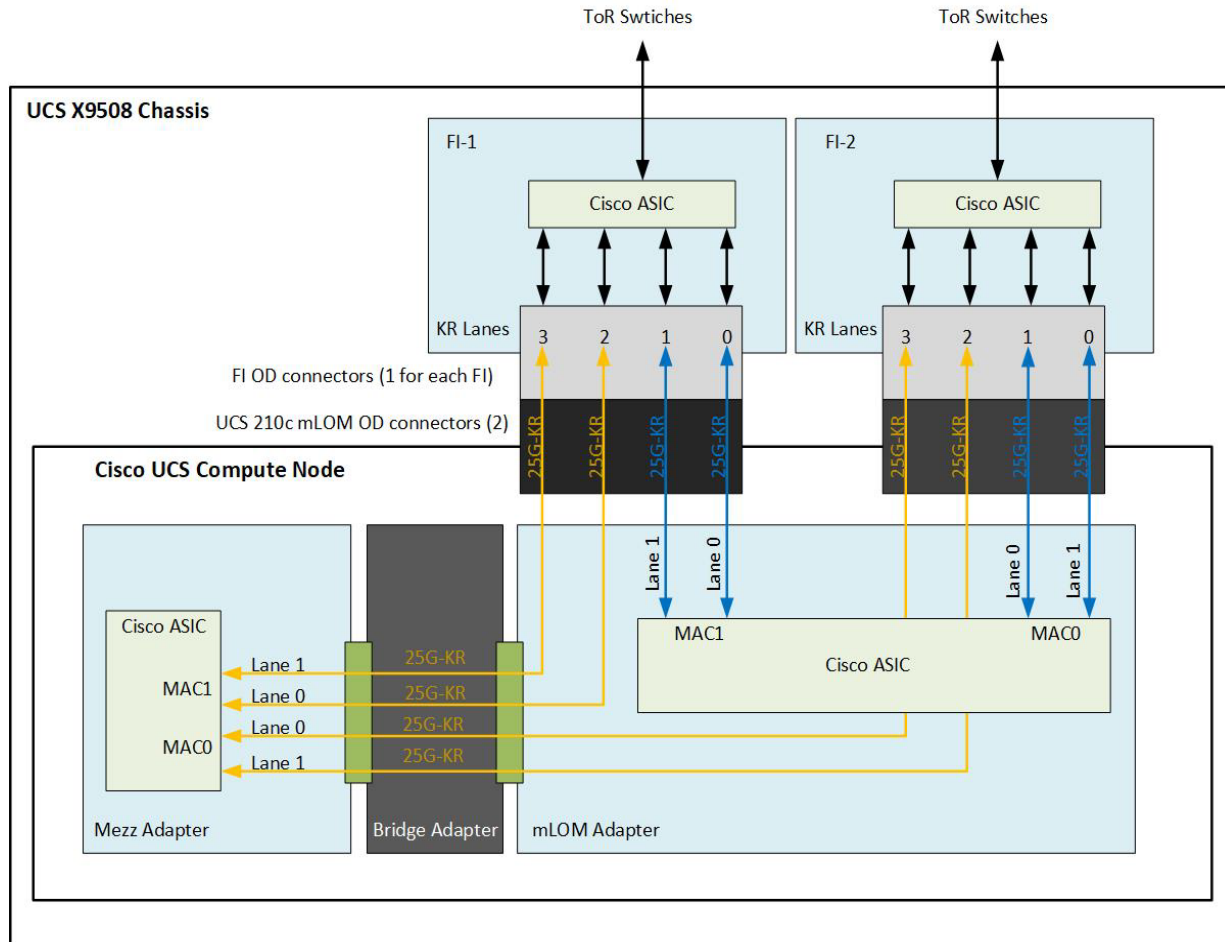

Figure 12 Single-VIC Network Connectivity mLOM 25G to FI

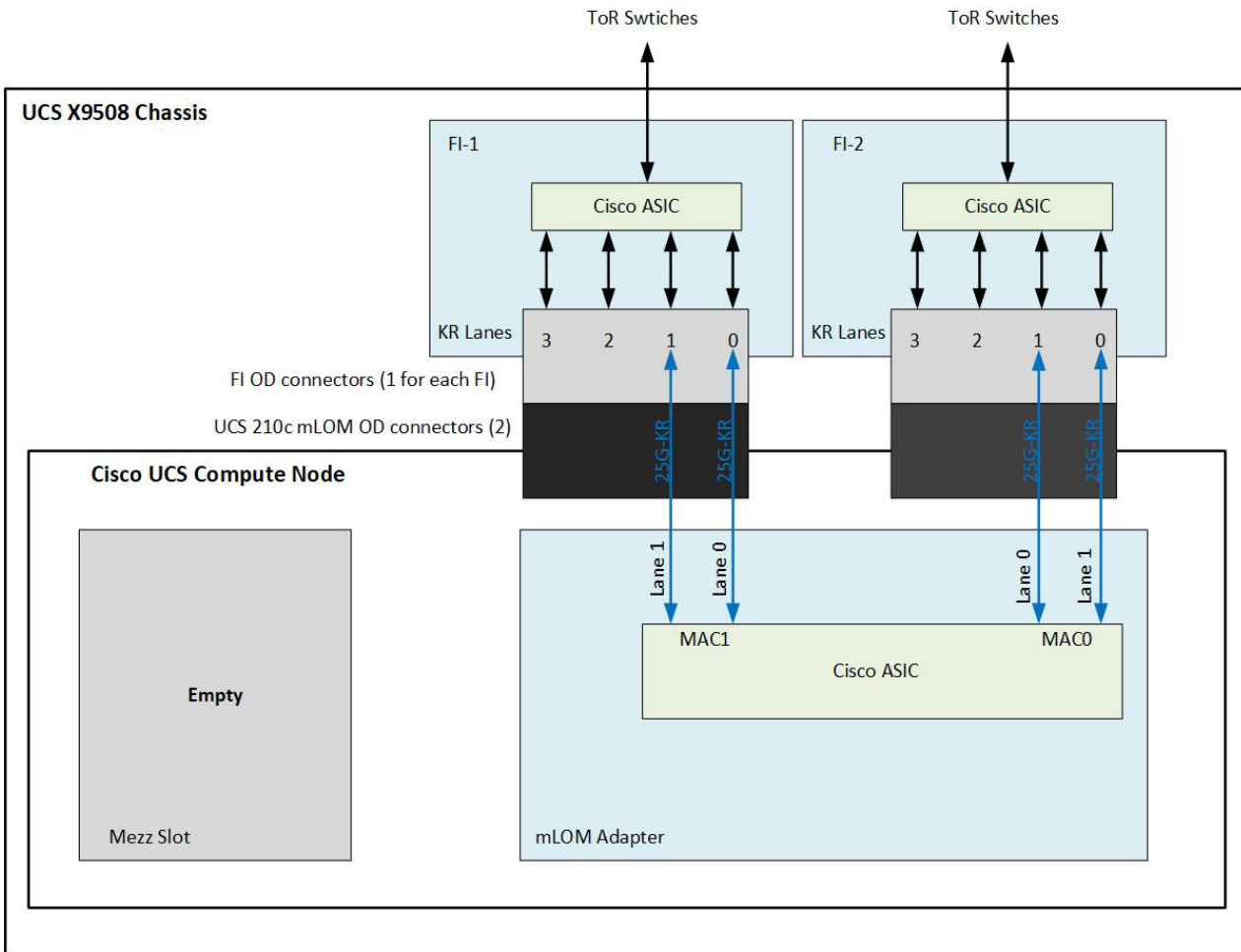
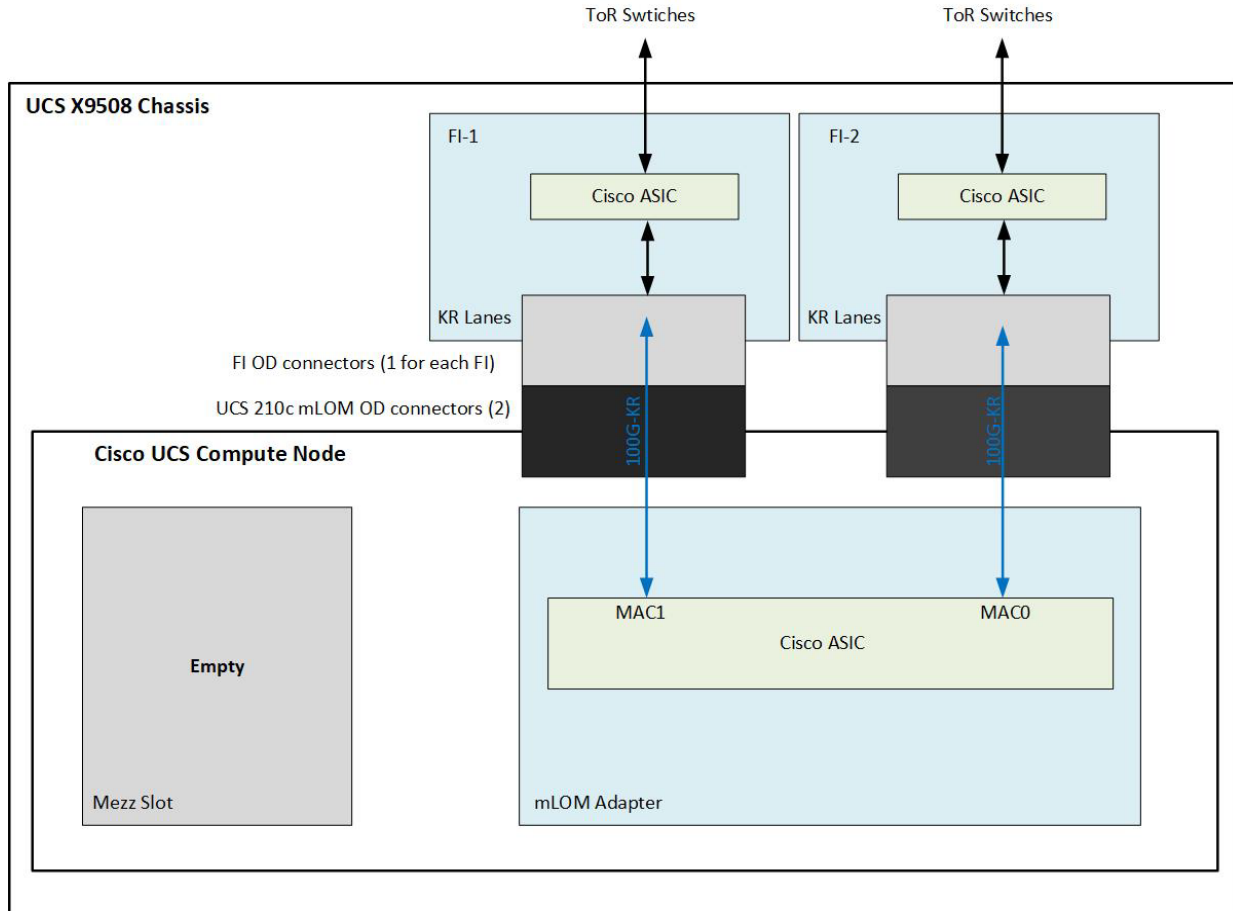

Figure 13 shows the network connectivity from the 100G mLOM out to the Cisco UCS Fabric Interconnect 9108 100G.

Figure 13 Network Connectivity mLOM 100G to FI





## TECHNICAL SPECIFICATIONS

### Physical Dimensions and Specifications

The physical and Environmental specifications for the for the Cisco UCS Fabric Interconnect 9108 100G are listed in listed in [Table 7](#)

**Table 7 Physical and Environmental Specifications**

Description	Specification
<b>Cisco UCS Fabric Interconnect 9108 100G</b>	
Dimensions (H x W x D)	1.67 in, x 14.93 in x 11.76 in. (4.2 cm x 37.9 cm x 29.9 cm)
Weight	8.42 lb (3.82 kg)
Temperature, operating	32 to 104° F (0 to 40° C)
Temperature, non-operating	-40 to 158° F (-40 to 70° C)
Humidity (RH), non-condensing	5 to 95%
Altitude	0 to 13,123 ft (0 to 4000 m)

## Compliance Specifications

The regulatory standards compliance (safety and EMC) specifications [Table 8](#).

**Table 8** The regulatory standards compliance (safety and EMC) specifications

Parameter	Description
Regulatory compliance	Products comply with CE Markings per directives 2004/108/EC and 2006/108/EC
Safety	<ul style="list-style-type: none"> <li>■ UL 60950-1</li> <li>■ CAN/CSA-C22.2 No. 60950-1</li> <li>■ EN 60950-1</li> <li>■ IEC 60950-1</li> <li>■ AS/NZS 60950-1</li> <li>■ GB4943</li> </ul>
EMC: Emissions	<ul style="list-style-type: none"> <li>■ 47CFR Part 15 (CFR 47) Class A (FCC Class A)</li> <li>■ AS/NZS CISPR22 Class A</li> <li>■ CISPR2 2 Class A</li> <li>■ EN55022 Class A</li> <li>■ ICES003 Class A</li> <li>■ VCCI Class A</li> <li>■ EN61000-3-2</li> <li>■ EN61000-3-3</li> <li>■ KN22 Class A</li> <li>■ CNS13438 Class A</li> </ul>
EMC: Immunity	<ul style="list-style-type: none"> <li>■ EN50082-1</li> <li>■ EN61000-6-1</li> <li>■ EN55024</li> <li>■ CISPR24</li> <li>■ EN300386</li> <li>■ KN 61000-4 Series</li> </ul>

## System Requirements

The system requirements are listed in [Table 9](#).

**Table 9** System requirements

Item	Requirement
X-Series chassis	Cisco UCS X9508 Chassis for Compute resources
Cisco Intersight or Cisco UCS Manager	Cisco Intersight Managed Mode or Cisco UCS Manager for management



**Americas Headquarters**  
Cisco Systems, Inc.  
San Jose, CA

**Asia Pacific Headquarters**  
Cisco Systems (USA) Pte. Ltd.  
Singapore

**Europe Headquarters**  
Cisco Systems International BV Amsterdam,  
The Netherlands

Cisco has more than 200 offices worldwide. Addresses, phone numbers, and fax numbers are listed on the Cisco Website at [www.cisco.com/go/offices](http://www.cisco.com/go/offices).

Cisco and the Cisco Logo are trademarks of Cisco Systems, Inc. and/or its affiliates in the U.S. and other countries. A listing of Cisco's trademarks can be found at [www.cisco.com/go/trademarks](http://www.cisco.com/go/trademarks). Third party trademarks mentioned are the property of their respective owners. The use of the word partner does not imply a partnership relationship between Cisco and any other company. (1005R)

