



Cisco IE 1000 Industrial Ethernet Switch Hardware Installation Guide

First Published: August 2016

Last Updated: August 2021

THE SPECIFICATIONS AND INFORMATION REGARDING THE PRODUCTS IN THIS MANUAL ARE SUBJECT TO CHANGE WITHOUT NOTICE. ALL STATEMENTS, INFORMATION, AND RECOMMENDATIONS IN THIS MANUAL ARE BELIEVED TO BE ACCURATE BUT ARE PRESENTED WITHOUT WARRANTY OF ANY KIND, EXPRESS OR IMPLIED. USERS MUST TAKE FULL RESPONSIBILITY FOR THEIR APPLICATION OF ANY PRODUCTS.

THE SOFTWARE LICENSE AND LIMITED WARRANTY FOR THE ACCOMPANYING PRODUCT ARE INCORPORATED HEREIN BY THIS REFERENCE. IF YOU ARE UNABLE TO LOCATE THE SOFTWARE LICENSE OR LIMITED WARRANTY, CONTACT YOUR CISCO REPRESENTATIVE FOR A COPY.

The following information is for FCC compliance of Class A devices: This equipment has been tested and found to comply with the limits for a Class A digital device, pursuant to part 15 of the FCC rules. These limits are designed to provide reasonable protection against harmful interference when the equipment is operated in a commercial environment. This equipment generates, uses, and can radiate radio-frequency energy and, if not installed and used in accordance with the instruction manual, may cause harmful interference to radio communications. Operation of this equipment in a residential area is likely to cause harmful interference, in which case users will be required to correct the interference at their own expense.

The following information is for FCC compliance of Class B devices: This equipment has been tested and found to comply with the limits for a Class B digital device, pursuant to part 15 of the FCC rules. These limits are designed to provide reasonable protection against harmful interference in a residential installation. This equipment generates, uses and can radiate radio frequency energy and, if not installed and used in accordance with the instructions, may cause harmful interference to radio communications. However, there is no guarantee that interference will not occur in a particular installation. If the equipment causes interference to radio or television reception, which can be determined by turning the equipment off and on, users are encouraged to try to correct the interference by using one or more of the following measures:

- ❑ Reorient or relocate the receiving antenna.
- ❑ Increase the separation between the equipment and receiver.
- ❑ Connect the equipment into an outlet on a circuit different from that to which the receiver is connected.
- ❑ Consult the dealer or an experienced radio/TV technician for help.

Modifications to this product not authorized by Cisco could void the FCC approval and negate your authority to operate the product.

The Cisco implementation of TCP header compression is an adaptation of a program developed by the University of California, Berkeley (UCB) as part of UCB's public domain version of the UNIX operating system. All rights reserved. Copyright © 1981, Regents of the University of California.

NOTWITHSTANDING ANY OTHER WARRANTY HEREIN, ALL DOCUMENT FILES AND SOFTWARE OF THESE SUPPLIERS ARE PROVIDED "AS IS" WITH ALL FAULTS. CISCO AND THE ABOVE-NAMED SUPPLIERS DISCLAIM ALL WARRANTIES, EXPRESSED OR IMPLIED, INCLUDING, WITHOUT LIMITATION, THOSE OF MERCHANTABILITY, FITNESS FOR A PARTICULAR PURPOSE AND NONINFRINGEMENT OR ARISING FROM A COURSE OF DEALING, USAGE, OR TRADE PRACTICE.

IN NO EVENT SHALL CISCO OR ITS SUPPLIERS BE LIABLE FOR ANY INDIRECT, SPECIAL, CONSEQUENTIAL, OR INCIDENTAL DAMAGES, INCLUDING, WITHOUT LIMITATION, LOST PROFITS OR LOSS OR DAMAGE TO DATA ARISING OUT OF THE USE OR INABILITY TO USE THIS MANUAL, EVEN IF CISCO OR ITS SUPPLIERS HAVE BEEN ADVISED OF THE POSSIBILITY OF SUCH DAMAGES.

Any Internet Protocol (IP) addresses and phone numbers used in this document are not intended to be actual addresses and phone numbers. Any examples, command display output, network topology diagrams, and other figures included in the document are shown for illustrative purposes only. Any use of actual IP addresses or phone numbers in illustrative content is unintentional and coincidental.

All printed copies and duplicate soft copies of this document are considered uncontrolled. See the current online version for the latest version.

Cisco has more than 200 offices worldwide. Addresses, phone numbers, and fax numbers are listed on the Cisco website at www.cisco.com/go/offices.

© 2016–2022 Cisco Systems, Inc. All rights reserved.



Preface

Audience

This guide is for the networking or computer technician responsible for installing Cisco IE 1000 series switches. We assume that you are familiar with the concepts and terminology of Ethernet and local area networking.

Purpose

This guide documents the hardware features of the Cisco IE 1000 switches. It describes the physical and performance characteristics of each switch, explains how to install a switch, and provides troubleshooting information.

This guide does not describe system messages that you might receive or how to configure your switch. For more information, see the Cisco IE 1000 documentation at

http://www.cisco.com/en/US/products/ps12451/tsd_products_support_series_home.html

Conventions

This document uses the following conventions and symbols for notes, cautions, and warnings.

Note: Means *reader take note*. Notes contain helpful suggestions or references to materials not contained in this manual.

Caution: Means *reader be careful*. In this situation, you might do something that could result in equipment damage or loss of data.

Warning: This warning symbol means danger. You are in a situation that could cause bodily injury. Before you work on any equipment, be aware of the hazards involved with electrical circuitry and be familiar with standard practices for preventing accidents. Use the statement number provided at the end of each warning to locate its translation in the translated safety warnings that accompanied this device. **Statement 1071**

The safety warnings for this product are translated into several languages in the *Regulatory Compliance and Safety Information for the Cisco IE 1000 Switch* that ships with the product. The EMC regulatory statements are also included in that guide.

Related Publications

Before installing, configuring, or upgrading the switch, see the release notes on Cisco.com for the latest information.

These documents provide complete information about the switch and are available on Cisco.com:

- *Product Document of Compliance for the Cisco IE 1000 Series Switch*.
- *Regulatory Compliance and Safety Information for the Cisco IE 1000 Switch*
- *Release Notes for the Cisco IE 1000 Switch*
- *Cisco IE 1000 Switch Device Manager Guide*

Obtaining Documentation, Obtaining Support, and Security Guidelines

- Device Manager online help (available on the switch)

These compatibility matrix documents are available from this Cisco.com site:

http://www.cisco.com/en/US/products/hw/modules/ps5455/products_device_support_tables_list.html

- *Cisco Gigabit Ethernet Transceiver Modules Compatibility Matrix* (not orderable but available on Cisco.com)
- *Cisco Small Form-Factor Pluggable Modules Compatibility Matrix* (not orderable but available on Cisco.com)

Obtaining Documentation, Obtaining Support, and Security Guidelines

For information on obtaining documentation, obtaining support, providing documentation feedback, security guidelines, and also recommended aliases and general Cisco documents, see the monthly *What's New in Cisco Product Documentation*, which also lists all new and revised Cisco technical documentation, at:

<http://www.cisco.com/en/US/docs/general/whatsnew/whatsnew.html>



Product Overview

The Cisco® Industrial Ethernet (IE) 1000 Series Switches are compact rugged switches aimed to operational technology (OT) users with limited IT network knowledge. The IE 1000 Series Switches provide an easy transformation from the legacy factory to digital solution. For machine builders and machine-to-machine (M2M) solutions is an attractive entry level product as a GUI-based, lightly-managed switch. The 1000 is a good fit for locations with harsh temperatures and small spaces, and is Power over Ethernet (PoE) capable with and zero IT management.

The 1000 is ideal for industrial Ethernet applications where small and easy-to-be-managed hardened products are required, including factory automation, intelligent transportation systems, city-surveillance programs, building automations etc.

The Cisco IE 1000 Series Switches complement the current industrial Ethernet portfolio of related Cisco industrial switches, such as the Cisco IE 2000, IE 3000, IE 4000 and IE 5000 Series Switches.

The 1000 can be easily installed on your network. Through a user-friendly web device manager, the 1000 provides easy out-of-the-box configuration and simplified operational manageability to deliver advanced and secure multiservices over industrial networks.

Switch Models Supported



Model	FE Uplink	Gig Uplink	FE Downlink		Description
	Copper	SFP	Copper	POE	
IE-1000-4T1T-LM	1		4		IE1K with total of 5 FE ports 10/100
IE-1000-6T2T-LM	2		6		IE1K with total of 8 FE ports 10/100
IE-1000-4P2S-LM		2		4	IE1K with 2 GE SFP, 4 PoE 10/100 with total of 6 ports
IE-1000-8P2S-LM		2		8	IE1K with 2 GE SFP, 8 PoE 10/100 with total of 10 ports

Front Panel Overview

The illustrations in this section provide an overview of the variety of components available on the various switch models in this product family. Not all models are illustrated.

Figure 1 Cisco IE-1000-4P2S-LM front panel shown

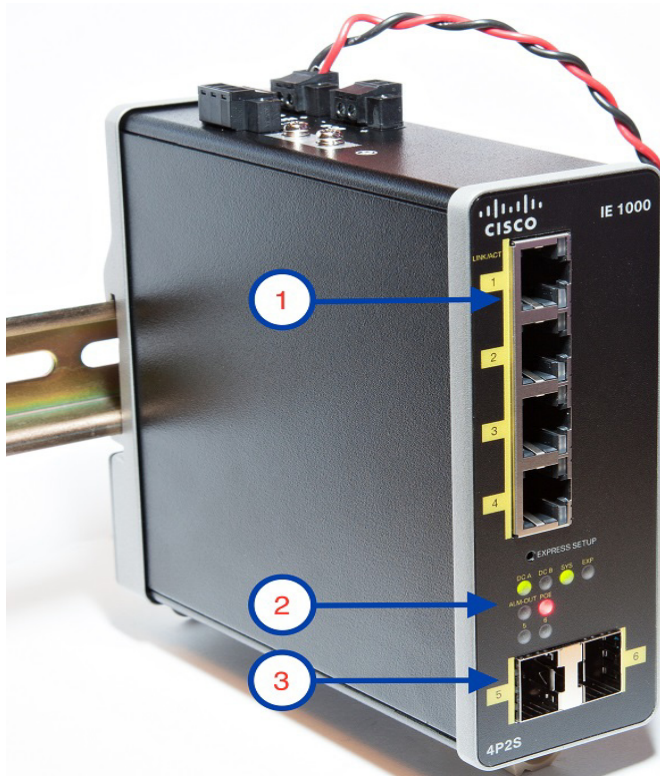

1	10/100 BASE-T ports	3	SFP module slots
2	LEDs		

Ports and Slots

Note: Different configurations are available. Not all ports or slots are present in all configurations.

10/100 BASE-T Downlink Ports

You can set the 10/100BASE-T downlink ports to operate at 10 or 100 Mb/s in full-duplex or half-duplex mode. You can also set these ports for speed and duplex autonegotiation in compliance with IEEE 802.3AB. (The default setting is autonegotiate.) When set for autonegotiation, the port senses the speed and duplex settings of the attached device and advertises its own capabilities. If the connected device also supports autonegotiation, the switch port negotiates the best connection (that is, the fastest line speed that both devices support, and full-duplex transmission if the attached device supports it) and configures itself accordingly. In all cases, the attached device must be within 328 feet (100 meters). 100BASE-TX traffic requires Category 5 cable. 10BASE-T traffic can use Category 3 or Category 4 cables.

When connecting the switch to workstations, servers, routers, and Cisco IP phones, make sure that the cable is a straight-through cable.

100/1000 Mb/s SFP Module Uplink Slots

The IEEE 802.3u 100 Mb/s SFP module uplink slots provide full-duplex 100 or 1000 Mb/s connectivity over multi-mode (MM) fiber cables or single-mode (SM) fiber cables. These ports use a SFP fiber-optic transceiver module that accepts a dual LC connector. Check the SFP specifications for the cable type and length.

SFP Modules Supported

The SFP modules are switch Ethernet SFP modules that provide connections to other devices. Depending on the switch model, these field-replaceable transceiver modules provide uplink or downlink interfaces. The modules have LC connectors for fiber-optic connections. For a complete list of supported SFP modules refer to the [Data Sheet](#).

Connectors

Figure 2 Cisco IE-1000-4P2S-LM top panel shown

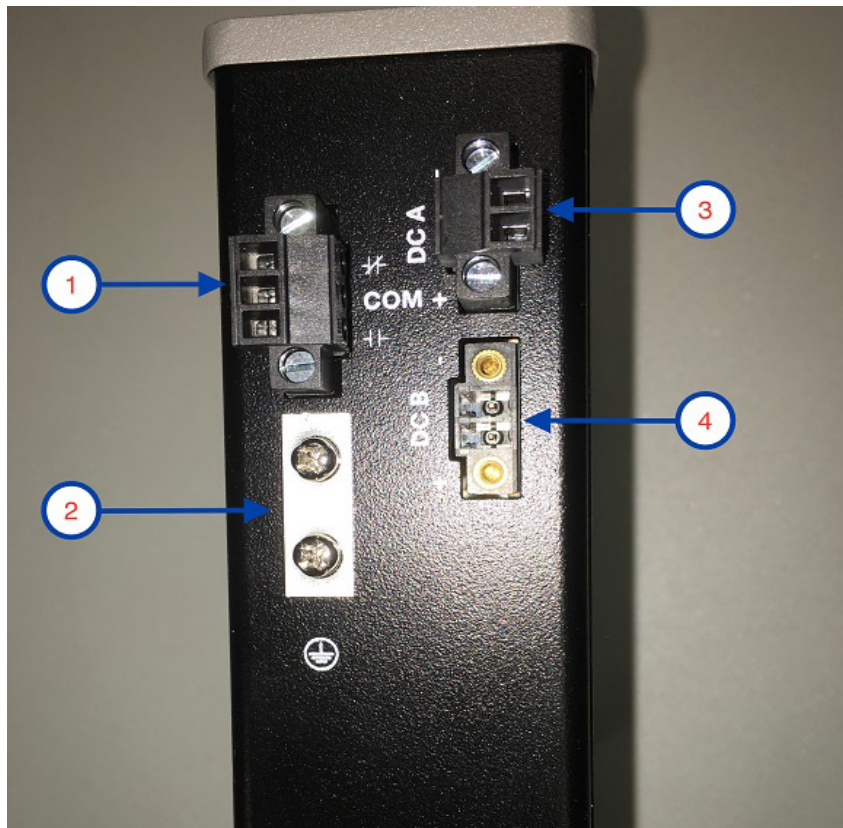

1	Alarm connector (PoE Models Only)	3	Power connector DC-A
2	Protective ground connection	4	Power connector DC-B (PoE Models Only)

DC Power Connector

You connect the DC power to the switch through the top panel connectors. The switch has a dual-feed DC power supply; two connectors provide primary and secondary DC power (DC-A and DC-B). See [Figure 1 on page 3](#). Each power connector has an LED status indicator.

The switch power connectors are attached to the switch chassis. Each power connector has screw terminals for terminating the DC power. All connectors are attached to the switch top panel with the provided captive screws.

The power connector labeling is on the panel. The positive DC power connection is labeled “+”, and the return connection is labeled “-”.

Alarm Connector (PoE Models Only)

The switch can operate with a single power source or with dual power sources. When both power sources are operational, the switch draws power from the DC source with the higher voltage. If one of the two power sources fail, the other continues to power the switch.

Alarm Connector (PoE Models Only)

You connect the alarm signals to the switch through the alarm connector. The switch supports one alarm output relay. The alarm connector is on the top panel.

The alarm connector provides three alarm wire connections. The connector is attached to the switch top panel with the provided captive screws.

The alarm output circuit is a relay with a normally open and a normally closed contact. The switch is configured to detect faults that are used to energize the relay coil and change the state on both of the relay contacts: normally open contacts close, and normally closed contacts open. The alarm output relay can be used to control an external alarm device, such as a bell or a light.

For more information about the alarm connector, see [Cable and Connectors, page 37](#)

LEDs

You can use the LEDs to monitor the switch status, activity, and performance. [Figure 3 on page 6](#) and [on page 8](#) show the front panel LEDs.

Figure 3 LEDs on the Cisco IE 1000 Switch (PoE Models Only)



DC A	Power connector DC-A LED	ALM-OUT (PoE Only)	Alarm Out LED
DC B (PoE Only)	Power connector DC-B LED	POE (PoE Only)	POE port status LED
SYS	System LED	5 (PoE Only)	SFP module slot LED
EXP	Express Setup LED	6 (PoE Only)	SFP module slot LED

Express Setup LED

The Express Setup LED displays the express setup mode for the initial configuration.

Color	Setup Status
Off (dark)	Switch is configured as a managed switch.
Solid green	Switch is operating normally.
Blinking green	Switch is in initial setup, in recovery, or initial setup is incomplete.
Solid red	Switch failed to start initial setup or recovery because there is no available switch port to which to connect the management station. Disconnect a device from a switch port, and then press the Express Setup button. The EXP LED will go RED when User attempts to enter Express Setup mode, but the switch has a startup-configuration already. Express Setup mode only works when the switch does NOT have a startup-configuration.

System LED

The System LED shows whether the system is receiving power and is functioning properly.

Color	System Status
Off	System is not powered on.
Green	System is operating normally.
Red	The switch failed ACT 2 verification. The configuration running on the switch is not compatible with the running software. Switch is not functioning properly.

Alarm OUT (PoE Models Only)

Color	System Status
Off	Alarm OUT is not configured, or the switch is off.
Green	Alarm OUT is configured, no alarm detected.
Blinking red	Switch has detected a major alarm.
Red	Switch has detected a minor alarm.

Power Status LEDs

The switch can operate with one or two DC power sources. Each DC input has an associated LED that shows the status of the corresponding DC input. If power is present on the circuit, the LED is green. If power is not present, the LED color depends on the alarm configuration. If alarms are configured, the LED is red when power is not present; otherwise, the LED is off.

If the switch has dual power sources, the switch draws power from the power source with the higher voltage. If one of the DC sources fails, the alternate DC source powers the switch, and the corresponding power status LED is green.

Color	System Status
Green	Power is present on the associated circuit, system is operating normally.
Off	Power is not present on the circuit, or the system is not powered up.
Red	Power is not present on the associated circuit, and the power supply alarm is configured.

The Power A and Power B LEDs show that power is not present on the switch if the power input drops below the low valid level. The power status LEDs only show that power is present if the voltage at the switch input exceeds the valid level.

Port Status LEDs

Each port and SFP uplink slot has a status LED, as shown in [Figure 3 on page 6](#) and described below.

Color	System Status
Off	No link.
Solid green	Link present.
Blinking green	Activity. Port is sending or receiving data.
Alternating green-amber	Link fault. Error frames can affect connectivity, and errors such as excessive collisions, CRC errors, and alignment and jabber errors are monitored for a link-fault indication.
Solid amber	Port is not forwarding. The port was disabled by management, an address violation, or STP. After a port is reconfigured, the port LED can remain amber for up to 30 seconds while STP checks the switch for possible loops.

PoE Status LED

The PoE STATUS LEDs are located on the front panel of POE capable models. The LEDs display the functionality and status of the adjacent PoE ports.

Rear Panel

The rear panel of the switch has a latch for installation on a DIN rail. See [Figure 4 on page 8](#). The latch is spring-loaded to move down to position the switch over a DIN rail and return to the original position to secure the switch to a DIN rail.

Figure 4 Cisco IE 1000 Switch Rear Panel

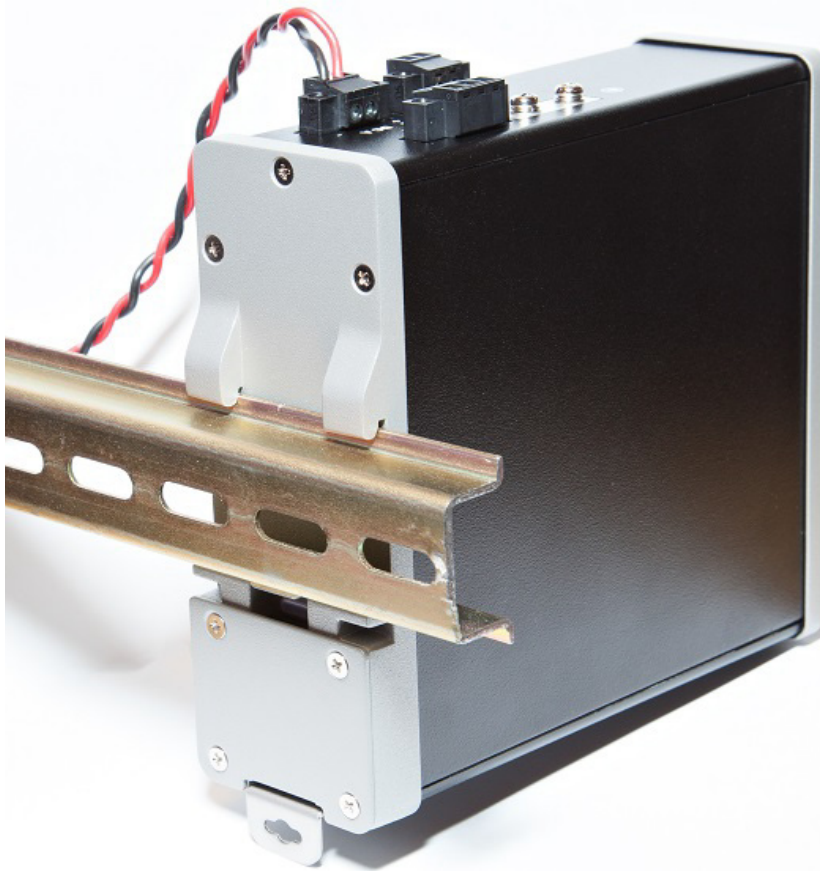

Management Options

The switch supports these management options:

- Device Manager

You can use Device Manager, which is in the switch memory, to manage individual and standalone switches. This web interface offers quick configuration and monitoring. You can access Device Manager from anywhere in your network through a web browser.

Network Configurations

See the switch software configuration guide on [Cisco.com](https://www.cisco.com) for network configuration concepts and examples of using the switch to create dedicated network segments and interconnecting the segments through Gigabit Ethernet connections.



Switch Installation

This chapter describes how to install your switch, verify the boot fast, and connect the switch to other devices. It also includes information specifically for installations in hazardous environments.

Read these topics, and perform the procedures in this order:

- [Preparing for Installation, page 11](#)
- [Connecting to Power, page 12](#)
- [Installing the Switch, page 19](#)
- [Connecting Alarm Circuits, page 21](#)
- [Connecting Destination Ports, page 23](#)
- [Where to Go Next, page 26](#)

Preparing for Installation

This section provides information about these topics:

- [Installation Guidelines, page 11](#)

Installation Guidelines

When determining where to place the switch, observe these guidelines.

Environment and Enclosure Guidelines

Review these environmental and enclosure guidelines before installation:

- This equipment is intended for use in a Pollution Degree 2 industrial environment, in overvoltage Category II applications (as defined in IEC publication 60664-1), at altitudes up to 9842 ft (3 km) without derating.
- This equipment is considered Group 1, Class A industrial equipment, according to IEC/CISPR Publication 11. Without appropriate precautions, there may be potential difficulties ensuring electromagnetic compatibility in other environments due to conducted as well as radiated disturbance.
- This equipment is supplied as open-type equipment. It must be mounted within an enclosure that is suitably designed for those specific environmental conditions that will be present and appropriately designed to prevent personal injury resulting from accessibility to live parts. The enclosure must have suitable flame-retardant properties to prevent or minimize the spread of flame, complying with a flame-spread rating of 5VA, V2, V1, V0 (or equivalent) if nonmetallic. The interior of the enclosure must be accessible only by the use of a tool. Subsequent sections of this publication might contain additional information regarding specific enclosure-type ratings that are required to comply with certain product safety certifications.

General Guidelines

Before installation, observe these general guidelines:

Caution: Proper ESD protection is required whenever you handle Cisco equipment. Installation and maintenance personnel should be properly grounded by using ground straps to eliminate the risk of ESD damage to the switch.

Do not touch connectors or pins on component boards. Do not touch circuit components inside the switch. When not in use, store the equipment in appropriate static-safe packaging.

- If you are responsible for the application of safety-related programmable electronic systems (PES), you need to be aware of the safety requirements in the application of the system and be trained in using the system.

Caution: The device is designed to mount on a DIN rail that conforms to Standard EN50022.

When determining where to place the switch, observe these guidelines:

- Before installing the switch, first verify that the switch is operational by powering it on and observing LEDs.
- For 10/100 ports, the cable length from a switch to an attached device cannot exceed 328 feet (100 meters).
- For 100BASE-FX fiber-optic ports, the cable length from a switch to an attached device cannot exceed 6562 ft (2 km).
- Clearance to front and rear panels meets these conditions:
 - Front-panel LEDs can be easily read.
 - Access to ports is sufficient for unrestricted cabling.
 - Front-panel direct current (DC) power connectors and the alarm connector are within reach of the connection to the DC power source.
- Airflow around the switch must be unrestricted. To prevent the switch from overheating, you must have the following minimum clearances:
 - Top and bottom: 2.0 in. (50.8 mm)
 - Sides: 1.0 in. (25.4 mm)
 - Front: 2.0 in. (50.8 mm)

Caution: When the switch is installed in an industrial enclosure, the temperature within the enclosure is greater than normal room temperature outside the enclosure.

Ensure temperatures inside the enclosure conform to device specifications detailed in [Table 1 on page 45](#).

- Cabling is away from sources of electrical noise, such as radios, power lines, and fluorescent lighting fixtures.

Connecting to Power

Tools and Equipment

Obtain these necessary tools and equipment:

- Ratcheting torque flathead screwdriver that exerts up to 18 in-lb (2.03 N-m) of pressure.
- For the protective ground connector, obtain a single or pair of stu size 6 ring terminals (such as Hollingsworth part number R3456B or equivalent).

Connecting to Power

- Crimping tool (such as Thomas & Bett part number WT4000, ERG-2001, or equivalent).
- 10-gauge copper ground wire.
- For DC power connections, use UL- and CSA-rated, style 1007 or 1569 twisted-pair copper appliance wiring material (AWM) wire.
- Wire-stripping tools for stripping 10- and 18-gauge wires.
- A number-2 Phillips screwdriver.
- A flat-blade screwdriver.

Supported Power Supplies

Table 1 Supported Power Supplies

	PWR-IE65W-PC-DC	PWR-IE65W-PC-AC	PWR-IE170W-PC-DC	PWR-IE170W-PC-AC	PWR-IE50W-AC-IEC	PWR-IE50W-AC
Current	DC-DC	AC-DC	DC-DC	AC-DC	AC-DC	AC-DC
Input	18-60 VDC/4.3 Amp	110/220 VAC and 88-300 VDC	10.8-60 VDC/23 Amp	110/220 VAC and 88-300 VDC/2.1 Amp	110/220 VAC	110/220VAC and 88-300 VDC
Output	54VDC/1.2 Amp	54VDC/1.2 Amp	54VDC/3.15 Amp	54VDC/3.15 Amp	24VDC/2.1Amp	24 VDC / 2.1Amp
Dimensions	5.9 in H x 2.1 in. W x 4.9 in. D	5.9 in. H x 2.1 in. W x 4.9 in. D	5.93 in (149.8mm) H x 4.47 in. (113.5 mm) W x 5.7 in. (144.7 mm) D	5.93 in. (150.6mm) H x 3.72 in. (94.5mm) W x 5.6 in. (142.2mm) D	5.8 in. H x 2 in. W x 4.4 in. D	5.8 in. H x 2 in. W x 4.4 in. D
Usage	Designed for up to 25W of POE load	Designed for up to 25W of POE load	Designed for up to 8 POE ports or 123W of POE power.	Designed for up to 8 POE ports or 123W of POE power.	No POE support	No POE support

Installing the Power Supply on a DIN Rail, Wall, or Rack Adapter

You install the power converter on a DIN rail, wall, or rack as you would a switch module.

Warning: This equipment is supplied as “open type” equipment. It must be mounted within an enclosure that is suitably designed for those specific environmental conditions that will be present and appropriately designed to prevent personal injury resulting from accessibility to live parts. The interior of the enclosure must be accessible only by the use of a tool.

The enclosure must meet IP 54 or NEMA type 4 minimum enclosure rating standards. Statement 1063

Caution: To prevent the switch assemble from overheating, there must be sufficient spacings as explained under [Installation Guidelines, page 11](#), between any other switch assembly.

Grounding the Switch

Make sure to follow any grounding requirements at your site.

Warning: This equipment must be grounded. Never defeat the ground conductor or operate the equipment in the absence of a suitably installed ground conductor. Contact the appropriate electrical inspection authority or an electrician if you are uncertain that suitable grounding is available. Statement 1024

Warning: This equipment is intended to be grounded to comply with emission and immunity requirements. Ensure that the switch functional ground lug is connected to earth ground during normal use. Statement 1064

Caution: To make sure that the equipment is reliably connected to earth ground, follow the grounding procedure instructions, and use a UL-listed ring terminal lug suitable for number 10-to-12 AWG wire, such as Hollingsworth part number R3456B or equivalent)

Caution: Use at least a 4 mm² (0.006 in²) conductor to connect to the external grounding screw.

The ground lug is not supplied with the switch. You can use one of the these options:

- Single ring terminal
- Two single ring terminals

To ground the switch to earth ground by using the ground screw, follow these steps:

1. Use a standard Phillips screwdriver or a ratcheting torque screwdriver with a Phillips head to remove the ground screw from the front panel of the switch. Store the ground screw for later use.
2. Use the manufacturer's guidelines to determine the wire length to be stripped.
3. Insert the ground wire into the ring terminal lug, and using a crimping tool, crimp the terminal to the wire. See [Figure 5 on page 14](#). If two ring terminals are being used, repeat this action for a second ring terminal.

Figure 5 Crimping the Ring Terminal

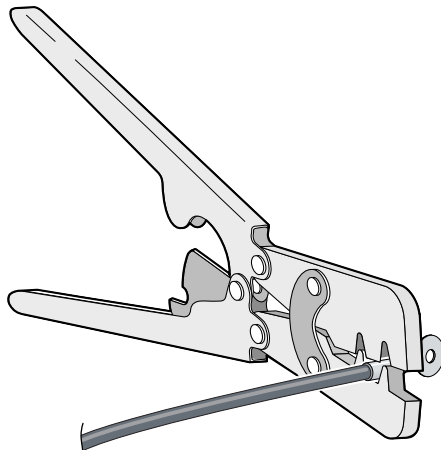

76666

4. Slide the ground screw through the terminal.
5. Insert the ground screw into the functional ground screw opening on the front panel.
6. Use a ratcheting torque screwdriver to tighten the ground screws and ring terminal to the switch top panel. The torque should not exceed 4.5 in-lb (0.51 N-m). See [Figure 6 on page 15](#).

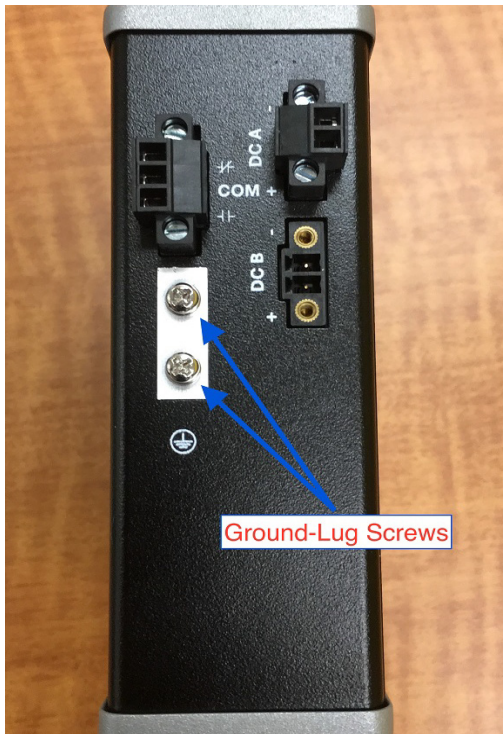
Figure 6 Ground-Lug Screw

7. Attach the other end of the ground wire to a grounded bare metal surface, such as a ground bus, a grounded DIN rail, or a grounded bare rack.

Connecting the Power Supply to a DC Power Source

You can also connect the power converter to a DC power source. Several power supplies can be used. Refer to [Supported Power Supplies, page 13](#) for the appropriate DC input ratings.

Note: Use copper conductors only, rated at a minimum temperature of 167°F (75°C).

Warning: Use twisted-pair supply wires suitable for 86°F (30°C) above surrounding ambient temperature outside the enclosure. **Statement 1067**

1. Measure a single length of stranded copper wire long enough to connect the power converter to the earth ground. The wire color might differ depending on the country that you are using it in.

For connections from the power converter to earth ground, use shielded 14-AWG stranded copper wire.

2. Measure a length of twisted-pair copper wire long enough to connect the power converter to the DC power source.

For DC connections from the power converter to the DC source, use 10-AWG twisted-pair copper wire.

3. Using a 14-gauge wire-stripping tool, strip the ground wire and both ends of the twisted pair wires to 0.25 inch (6.3 mm) ± 0.02 inch (0.5 mm). Do not strip more than 0.27 inch (6.8 mm) of insulation from the wires. Stripping more than the recommended amount of wire can leave exposed wire from the power and relay connector after installation.
4. Connect one end of the stranded copper wire to a grounded bare metal surface, such as a ground bus, a grounded DIN rail, or a grounded bare rack.

Connecting to Power

5. Insert the other end of the exposed ground wire lead into the earth-ground wire connection on the power converter terminal block. Note that the position of the power converter may vary on different switch models.
6. Tighten the earth-ground wire connection terminal block screw.

Note: Torque to 8 in.-lb, not to exceed 10 in-lb.

Warning: An exposed wire lead from a DC-input power source can conduct harmful levels of electricity. Be sure that no exposed portion of the DC-input power source wire extends from the power and relay connector. Statement 122

7. Insert the twisted-pair wire leads into the terminal block line and neutral connections. Insert the wire (labeled number 1 in [Figure 6 on page 15](#)) lead into the neutral wire connection and the wire (labeled number 2 in [Figure 6 on page 15](#)) lead into the line wire connection. Ensure that only wire *with insulation* extends from the connectors. See [Figure 6 on page 15](#).
8. Tighten the line and neutral terminal block screws.

Note: Torque to 8 in.-lb, not to exceed 10 in-lb.

9. Connect the red wire to the positive pole of the DC power source, and connect the black wire to the return pole. Ensure that each pole has a current-limiting-type fuse rated to 30 Amp.

Wiring the DC Power Source

Read these cautions and warnings before wiring the switch to the DC power source.

Warning: A readily accessible two-poled disconnect device must be incorporated in the fixed wiring. Statement 1022

Warning: This product relies on the building's installation for short-circuit (overcurrent) protection. Ensure that the protective device is rated not greater than: 6A. Statement 1005

Warning: Installation of the equipment must comply with local and national electrical codes. Statement 1074

Warning: Before performing any of the following procedures, ensure that power is removed from the DC circuit. Statement 1003

Warning: Only trained and qualified personnel should be allowed to install, replace, or service this equipment. Statement 1030

Caution: For wire connections to the power and alarm connectors, you must use UL- and CSA-rated, style 1007 or 1569 twisted-pair copper appliance wiring material (AWM) wire (such as Belden part number 9318).

To wire the switch to a DC power source, follow these steps:

1. Locate the two power connectors on the switch front panel labeled DC-A and DC-B.

Note: Non-PoE units have only one power connection (DC-A).

2. Identify the connector positive and return DC power connections. The labels for power connectors DC-A and DC-B are on the switch panel as displayed below.

Label	Connection
+	Positive DC power connection
-	Return DC power connection

3. Measure two strands of twisted-pair copper wire (16-to-18 AWG) long enough to connect to the DC power source.

- Using an 18-gauge wire-stripping tool, strip each of the two twisted pair wires coming from each DC-input power source to 0.25 inch (6.3 mm) \pm 0.02 inch (0.5 mm). Do not strip more than 0.27 inch (6.8 mm) of insulation from the wire. Stripping more than the recommended amount of wire can leave exposed wire from the power connector after installation.

Figure 7 Stripping the Power Connection Wire

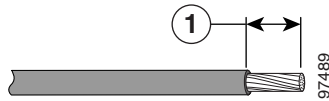

1	0.25 in. (6.3 mm) \pm 0.02 in. (0.5 mm)
---	---

- Remove the two captive screws that attach the power connector to the switch, and remove the power connector. Remove both connectors if you are connecting to two power sources. See [Figure 8 on page 17](#).

Figure 8 Removing the Power Connectors from the Switch

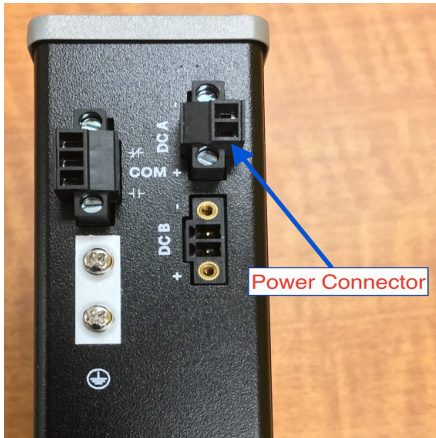

- On the power connector, insert the exposed part of the positive wire into the connection labeled “+” and the exposed part of the return wire into the connection labeled “-”. Make sure that you cannot see any wire lead. Only wire *with insulation* should extend from the connector.

Warning: An exposed wire lead from a DC-input power source can conduct harmful levels of electricity. Be sure that no exposed portion of the DC-input power source wire extends from the connector(s) or terminal block(s).
Statement 122

- Use a ratcheting torque flathead screwdriver to torque the power connector captive screws (above the installed wire leads) to 2in-lb (0.226 Nm).

Caution: Do not over-torque the power connector’s captive screws. The torque should not exceed 2in-lb (0.226 Nm).

- Connect the other end of the positive wire to the positive terminal on the DC power source, and connect the other end of the return wire to the return terminal on the DC power source.

When you are testing the switch, one power connection is sufficient. If you are installing the switch and are using a second power source, repeat [Step 4](#) through [Step 8](#) using the second power connector.

Attaching the Power Connectors to the Switch

To attach the power connectors to the front panel of the switch, follow these steps:

1. Insert one power connector into the DC-A receptacle on the switch front panel, and the other into the DC-B receptacle. See [Figure 8 on page 17](#).

Warning: Installation of the equipment must comply with local and national electrical codes. Statement 1074

2. Use a ratcheting torque flathead screwdriver to tighten the captive screws on the sides of the power connectors to 1.6 in/lbs.

Caution: Do not exceed 1.6 In/lbs.

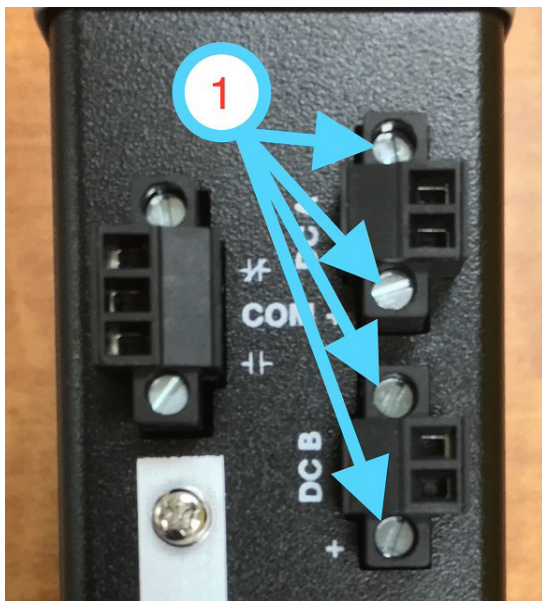

Table 2 Power Connector Captive Screws

1	Captive Screws (Tighten to 1.6 in/lbs)
---	--

When you are testing the switch, one power source is sufficient. If you are installing the switch and are using a second power source, repeat this procedure for the second power connector (DC-B), which installs just below the primary power connector (DC-A).

When you are installing the switch, secure the wires coming from the power connector so that they cannot be disturbed by casual contact. For example, use tie wraps to secure the wires to the rack.

Applying Power to the Power Converter

Move the circuit breaker for the AC outlet or the DC control circuit to the *on* position.

The LED on the power converter front panel is green when the unit is operating normally. The LED is off when the unit is not powered or is not operating normally. After the power is connected, the switch automatically begins the power-on self- test (POST), a series of tests that verifies that the switch functions properly.

Installing the Switch

This section describes how to install the switch:

- [Installing the Switch on a DIN Rail, page 19](#)
- [Removing the Switch from a DIN Rail, page 20](#)

Warning: This equipment is supplied as “open type” equipment. It must be mounted within an enclosure that is suitably designed for those specific environmental conditions that will be present and appropriately designed to prevent personal injury resulting from accessibility to live parts. The interior of the enclosure must be accessible only by the use of a tool.

The enclosure must meet IP 54 or NEMA type 4 minimum enclosure rating standards. Statement 1063

Warning: When used in a Class I, Division 2, hazardous location, this equipment must be mounted in a suitable enclosure with proper wiring method, for all power, input and output wiring, that complies with the governing electrical codes and in accordance with the authority having jurisdiction over Class I, Division 2 installations. Statement 1066

Caution: To prevent the switch from overheating, ensure these minimum clearances:

- Top and bottom: 2.0 in. (50.8 mm)
- Exposed side: 1.0 in. (25.4 mm)
- Front: 2.0 in. (50.8 mm)

Installing the Switch on a DIN Rail

The switch ships with a spring-loaded latch on the rear panel for a mounting on a DIN rail.

To attach the switch to a DIN rail, follow these steps:

1. Position the rear panel of the switch directly in front of the DIN rail, making sure that the DIN rail fits in the space between the two hooks near the top of the switch and the spring-loaded latch near the bottom.
2. Holding the bottom of the switch away from the DIN rail, place the two hooks on the back of the switch over the top of the DIN rail.

Caution: Do not stack any equipment on the switch.

Figure 9 Switch mounted on DIN Rail

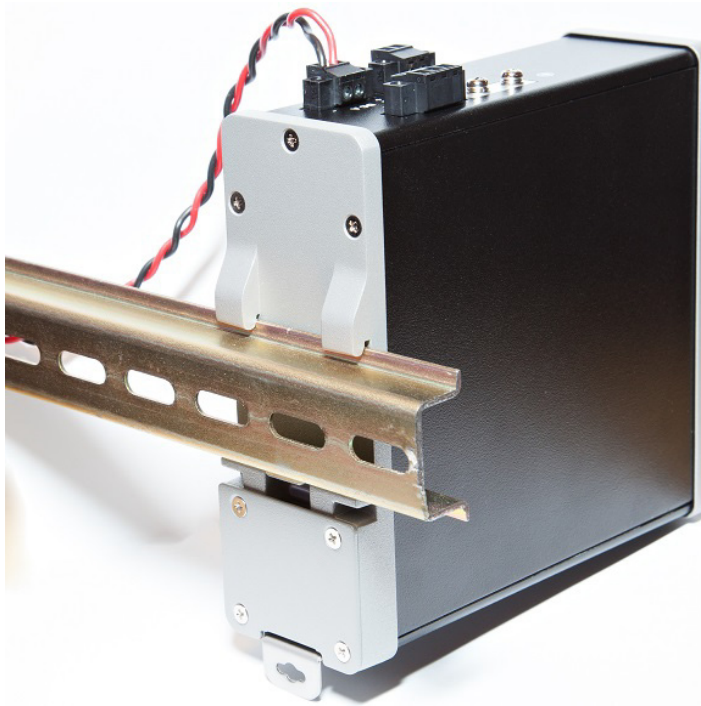

3. Push the switch toward the DIN rail to cause the spring-loaded latch at the bottom rear of the switch to move down, and snap into place.

After the switch is mounted on the DIN rail, connect the power and alarm wires, as described in [Connecting Alarm Circuits, page 21](#).

Removing the Switch from a DIN Rail

To remove the switch from a DIN rail, follow these steps:

1. Ensure that power is removed from the switch, and disconnect all cables and connectors from the front panel of the switch.
2. Insert a tool such as a flathead screwdriver in the slot at the bottom of the spring-loaded latch and use it to release the latch from the DIN rail. See [Figure 10 on page 21](#).
3. Pull the bottom of the switch away from the DIN rail, and lift the hooks off the top of the DIN rail. See [Figure 10 on page 21](#).

Figure 10 Releasing the Spring-Loaded Latch from the DIN Rail

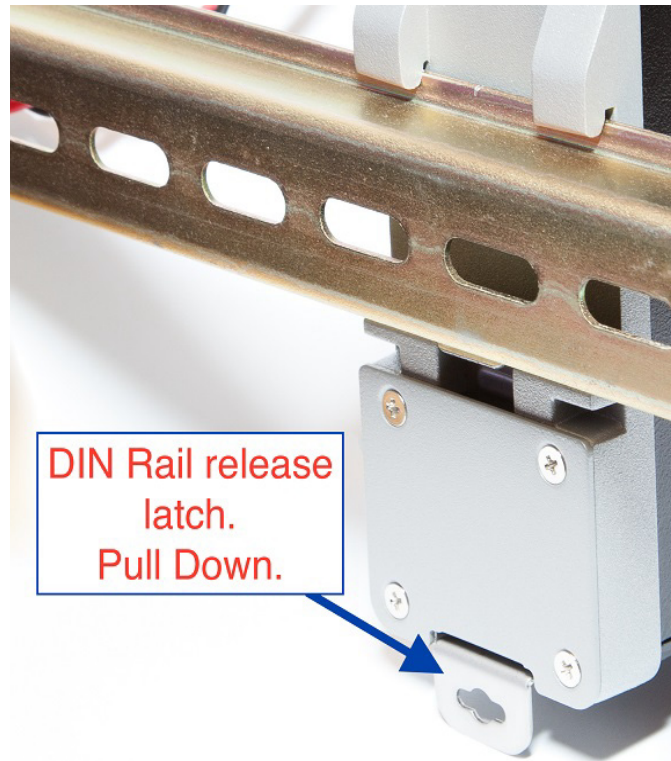

4. Remove the switch from the DIN rail.

Connecting Alarm Circuits

After the switch is installed, you are ready to connect the DC power and alarm connections.

- [Wiring the Protective Ground and DC Power for Alarm Circuits, page 21](#)
- [Wiring the External Alarms, page 21](#)

Wiring the Protective Ground and DC Power for Alarm Circuits

For instructions on grounding the switch and connecting the DC power, see the [Grounding the Switch, page 13](#).

Wiring the External Alarms

The switch has one alarm output relay circuit for external alarms. The alarm output relay circuit has a normally open and a normally closed contact.

Alarm signals are connected to the switch through the 3-pin alarm connector. The three connections are for the alarm output circuit: a normally open output, a normally closed output, and a common signal. An alarm output and the common wiring connection are required to complete a single alarm output circuit.

The labels for the alarm connector are on the switch panel and are displayed below.

Label	Connection
-/-	Alarm Output Normally Closed (NC) connection
COM	Alarm Output Common connection
- -	Alarm Output Normally Open (NO) connection

Warning: Explosion Hazard—Do not connect or disconnect wiring while the field-side power is on; an electrical arc can occur. This could cause an explosion in hazardous location installations. Be sure that power is removed or that the area is nonhazardous before proceeding. Statement 1081

Caution: The input voltage source of the alarm output relay circuit must be an isolated source and limited to less than or equal to 24 VDC, 1.0 A or 48 VDC, 0.5 A.

Note: Wire connections to the power and alarm connectors must be UL- and CSA-rated, style 1007 or 1569 twisted-pair copper appliance wiring material (AWM) wire (such as Belden part number 9318).

To wire the switch to an external alarm device, follow these steps:

1. Remove the captive screws that hold the alarm connector on the switch, and remove the connector from the switch chassis. See [Figure 11 on page 22](#).

Figure 11 Alarm Connector

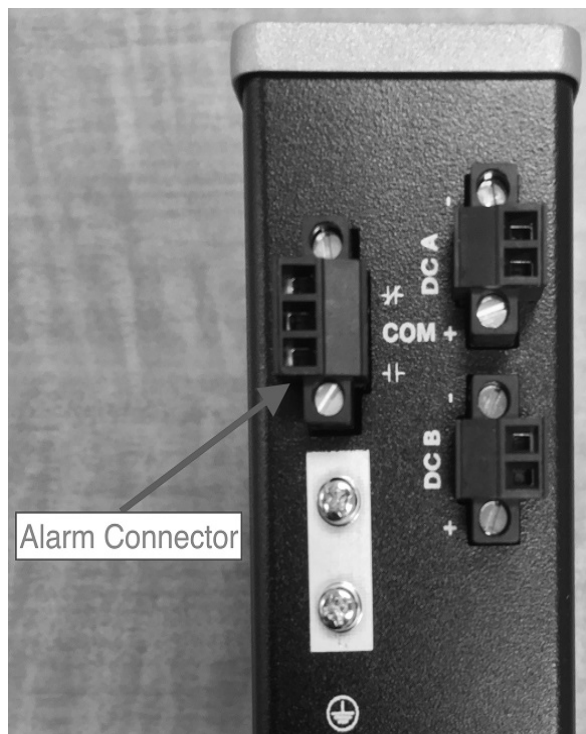

2. Measure two strands of twisted-pair wire (16-to-18 AWG) long enough to connect to the external alarm device. Choose between setting up an external alarm input or output circuit.
3. Use a wire stripper to remove the casing from both ends of each wire to 0.25 inch (6.3 mm) ± 0.02 inch (0.5 mm). Do not strip more than 0.27 inch (6.8 mm) of insulation from the wires. Stripping more than the recommended amount of wire can leave exposed wire from the alarm connector after installation.

Connecting Destination Ports

4. Insert the exposed wires for the external alarm device into the connections based on an alarm input or output circuit setup.
5. Use a ratcheting torque flathead screwdriver to tighten the alarm connector captive screw (above the installed wire leads) to 2 in-lb (0.226 Nm).

Caution: Do not over-torque the power and alarm connectors' captive screws. The torque should not exceed 2 in-lb (0.226 Nm).

6. Repeat [Step 2](#) through [Step 5](#) to insert the input and output wires of one additional external alarm device into the alarm connector.

Attaching the Alarm Connector to the Switch

Warning: Failure to securely tighten the captive screws can result in an electrical arc if the connector is accidentally removed. Statement 397

Warning: When you connect or disconnect the power and/or alarm connector with power applied, an electrical arc can occur. This could cause an explosion in hazardous area installations. Be sure that all power is removed from the switch and any other circuits. Be sure that power cannot be accidentally turned on or verify that the area is nonhazardous before proceeding. Statement 1058

To attach the alarm connector to the front panel of the switch, follow these steps:

1. Insert the alarm connector into the receptacle on the switch top panel.
2. Use a ratcheting torque flathead screwdriver to tighten the captive screws on the sides of the alarm connector to 1.6 in-lbs (0.181 Nm).

Caution: Do not exceed 1.6 In-lbs (0.181 Nm).

Connecting Destination Ports

These section provide more information about connecting to the destination ports:

- [Connecting to 10/100 Ports, page 23](#)
- [Installing and Removing SFP Modules, page 24](#)
- [Connecting to SFP Modules, page 26](#)

Connecting to 10/100 Ports

The switch 10/100 ports automatically configure themselves to operate at the speed of attached devices. If the attached ports do not support autonegotiation, you can explicitly set the speed and duplex parameters. Connecting devices that do not autonegotiate or that have their speed and duplex parameters manually set can reduce performance or result in no linkage.

To maximize performance, choose one of these methods for configuring the Ethernet ports:

- Let the ports autonegotiate both speed and duplex.
- Set the port speed and duplex parameters on both ends of the connection.

The models that support PoE provide up to eight ports of PoE.

Caution: To prevent electrostatic-discharge (ESD) damage, follow your normal board and component handling procedures.

To connect to 10BASE-T, or 100BASE-T devices, follow these steps:

1. When connecting to workstations, servers, routers, and Cisco IP phones, connect a straight-through cable to an RJ-45 connector on the front panel.
2. Connect the other end of the cable to an RJ-45 connector on the other device. The port LED turns on when both the switch and the connected device have established a link.

The port LED is amber while Spanning Tree Protocol (STP) discovers the topology and searches for loops. This can take up to 30 seconds, and then the port LED turns green. If the port LED does not turn on:

- The device at the other end might not be turned on.
 - There might be a cable problem or a problem with the adapter installed in the attached device.
3. Reconfigure and reboot the connected device if necessary.
 4. Repeat Steps 1 through 3 to connect each device.

Installing and Removing SFP Modules

These sections describe how to install and remove SFP modules. SFP modules are inserted into SFP module slots on the front of the switch. These field-replaceable modules provide the uplink optical interfaces, send (TX) and receive (RX).

You can use any combination of rugged SFP modules. Each SFP module must be of the same type as the SFP module on the other end of the cable, and the cable must not exceed the stipulated cable length for reliable communications.

For detailed instructions on installing, removing, and cabling the SFP module, see your SFP module documentation.

Warning: Do not insert and remove SFP modules while power is on; an electrical arc can occur. This could cause an explosion in hazardous location installations. Be sure that power is removed or the area is nonhazardous before proceeding. Statement 1087

Installing SFP Modules into SFP Module Slots

Figure 12 on page 25 shows an SFP module that has a bale-clasp latch.

Caution: We strongly recommend that you do not install or remove the SFP module with fiber-optic cables attached to it because of the potential damage to the cables, the cable connector, or the optical interfaces in the SFP module. Disconnect all cables before removing or installing an SFP module.

Removing and installing an SFP module can shorten its useful life. Do not remove and insert SFP modules more often than is absolutely necessary.

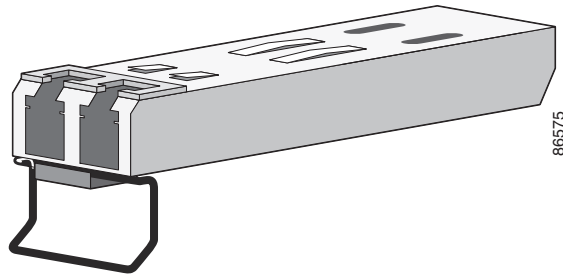
Figure 12 SFP Module with a Bale-Clasp Latch

To insert an SFP module into the SFP module slot:

1. Attach an ESD-preventive wrist strap to your wrist and to a grounded bare metal surface.
2. Find the send (TX) and receive (RX) markings that identify the correct side of the SFP module.

On some SFP modules, the send and receive (TX and RX) markings might be replaced by arrows that show the direction of the connection, either send or receive (TX or RX).

3. Align the SFP module sideways in front of the slot opening.
4. Insert the SFP module into the slot until you feel the connector on the module snap into place in the rear of the slot.
5. Remove the dust plugs from the SFP module optical ports and store them for later use.

Caution: Do not remove the dust plugs from the SFP module port or the rubber caps from the fiber-optic cable until you are ready to connect the cable. The plugs and caps protect the SFP module ports and cables from contamination and ambient light.

6. Insert the LC cable connector into the SFP module.

Removing SFP Modules from SFP Module Slots

To remove an SFP module from a module receptacle:

1. Attach an ESD-preventive wrist strap to your wrist and to a grounded bare metal surface.
2. Disconnect the LC from the SFP module.
3. Insert a dust plug into the optical ports of the SFP module to keep the optical interfaces clean.
4. Unlock and remove the SFP module.

If the module has a bale-clasp latch, pull the bale out and down to eject the module. If the bale-clasp latch is obstructed and you cannot use your index finger to open it, use a small, flat-blade screwdriver or other long, narrow instrument to open the bale-clasp latch.

5. Grasp the SFP module between your thumb and index finger, and carefully remove it from the module slot.
6. Place the removed SFP module in an antistatic bag or other protective environment.

Connecting to SFP Modules

This section describes how to connect to a fiber-optic SFP port. For instructions on how to install or remove an SFP module, see [Installing and Removing SFP Modules, page 24](#).

Warning: Class 1 laser product. Statement 1008

Warning: Do not connect or disconnect cables to the ports while power is applied to the switch or any device on the network because an electrical arc can occur. This could cause an explosion in hazardous location installations. Be sure that power is removed from the switch and cannot be accidentally be turned on, or verify that the area is nonhazardous before proceeding. Statement 1070

Caution: Do not remove the rubber plugs from the SFP module port or the rubber caps from the fiber-optic cable until you are ready to connect the cable. The plugs and caps protect the SFP module ports and cables from contamination and ambient light.

Before connecting to the SFP module, be sure that you understand the port and cabling guidelines in the [Preparing for Installation, page 11](#).

To connect a fiber-optic cable to an SFP module, follow these steps:

1. Remove the rubber plugs from the module port and fiber-optic cable, and store them for future use.
2. Insert one end of the fiber-optic cable into the SFP module port.
3. Insert the other cable end into a fiber-optic receptacle on a target device.
4. Observe the port status LED:
 - The LED turns green when the switch and the target device have an established link.
 - The LED turns amber while the STP discovers the network topology and searches for loops. This process takes about 30 seconds, and then the port LED turns green.
 - If the LED is off, the target device might not be turned on, there might be a cable problem, or there might be a problem with the adapter installed in the target device. See [Troubleshooting, page 33](#) for solutions to cabling problems.
5. If necessary, reconfigure and restart the switch or the target device.

Where to Go Next

If the default configuration is satisfactory, the switch does not need further configuration. You can use any of these management options to change the default configuration:

- Start Device Manager, which is in the switch memory, to manage individual and standalone switches. This is an easy-to-use web interface that offers quick configuration and monitoring. You can access Device Manager from anywhere in your network through a web browser. For more information, see the *Express Setup* section of the Device Manager online help.



Running Express Setup

When you first set up the switch, you should use Express Setup to enter the initial IP information. This process enables the switch to connect to local routers and the Internet. You can then access the switch through the IP address for additional configuration.

Required Equipment

You need this equipment to set up the switch:

- Computer with Windows 7/Windows 10/Mac
- Web browser (Microsoft Internet Explorer 11, Firefox 46.01 and 47.0, or Microsoft Edge 89.0) with JavaScript enabled. (Disable pop-up blockers and proxy settings and ensure that your browser is using the English EN-US language pack.)

Note: Firmware upgrade may fail or will never complete when initiated using a browser language pack other than en-US.

- A straight-through or crossover Category 5 Ethernet cable to connect your computer to the switch port.
- A small paper clip to reach the express setup button.

Note: Before running Express Setup, disable any wireless client running on your computer.

Express Setup Procedure

To run Express Setup:

1. Make sure that nothing is connected to the switch.
2. Connect power to the switch.

See the wiring instructions in the “Grounding the Switch” section and the “Wiring the DC Power Source” section on page 19.

3. Power on or reset the IE 1000:
 - Use LEDs to monitor boot progress
 - Sys Blank: POST
 - Sys solid: exit post, initializing
 - Sys and alarm LEDs green: init done
 - ~25 seconds after power-on



4. Ensure the IE 1000 is in default factory mode.
Skip to next step if freshly out of the box
 - a. If not freshly out of the package, use a paper clip to reset the switch by depressing the express setup button for 15 - 20 seconds until the EXP LED alternates green - red; then release the paper clip.
 - b. Switch will automatically reboot
5. Ensure no data port is connected to the switch.
Note: During Express Setup, the switch acts as a DHCP server.
 - Ensure the computer connected to switch is configured to receive an IP address from the DHCP server.
6. Insert paper clip into express setup button for 1-2 seconds
 - When released, EXP LED starts flashing green.
7. Connect computer to port Fa 1/1, LED continues to blink
8. Ensure the computer has received the IP Address 192.168.1.1,
9. Point browser to <http://192.168.1.254>
10. Leave the **username** blank and enter the default password, **cisco**.
NoteThe Express Setup window appears.
 - a. Troubleshooting: If the Express Setup window does not appear, make sure that any pop-up blockers or proxy settings on your browser are disabled and that any wireless client is disabled on your computer.

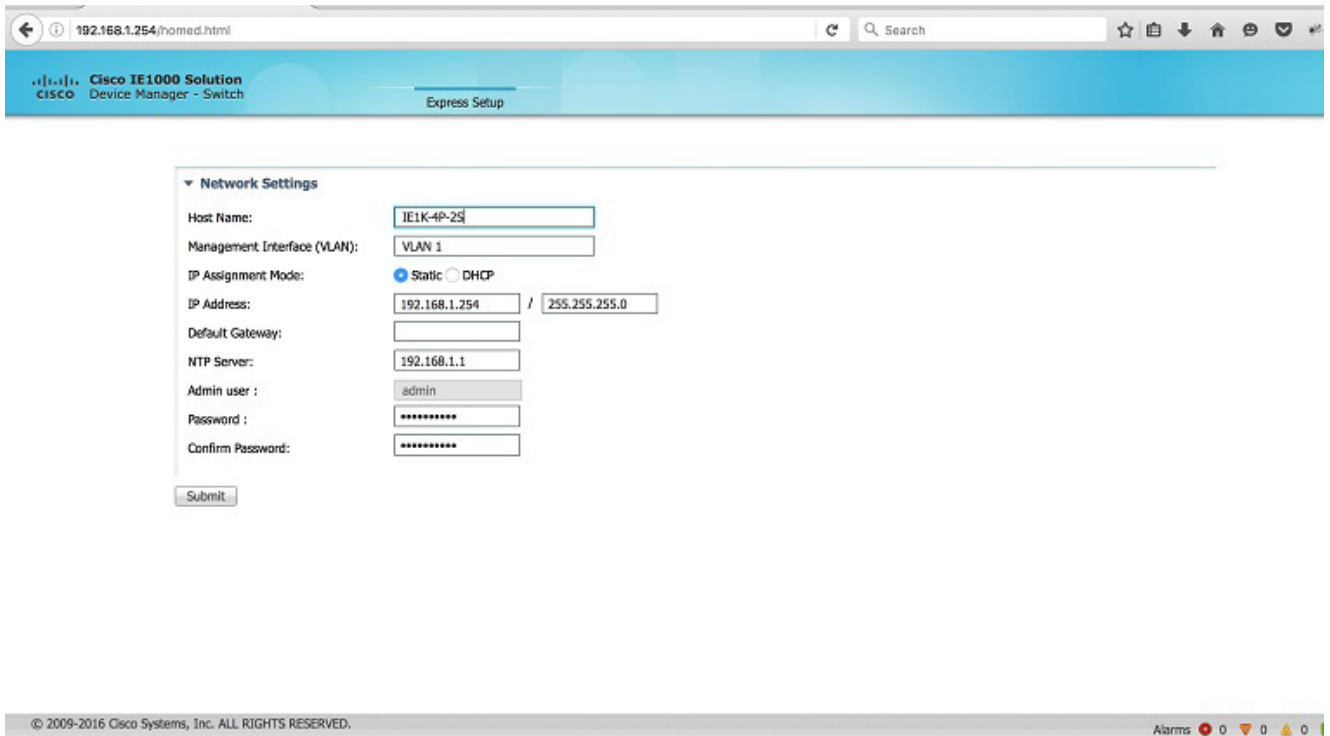

11. Enter all entries in English letters and Arabic numbers.

In the Network Settings (Required for Static IP):

- New Admin User: Password must be from 8–31 characters long, contain upper and lower case characters, a number and a symbol (!@#%\$%^).
- **IP Address:** Enter a valid IP address for the switch.
You can later use the IP address to access the switch through Device Manager.
- (Optional) Default Gateway: Enter the IP address of the router.

Note: The Device manager will not allow you to exit the express setup page if the static IP address of the IE 1000 and the Default Gateway are not in the same subnet.

12. Optional Settings

You can enter the optional information now, or enter it later by using Device Manager. For more information about the Express Setup fields, see the on-line help for the Express Setup window.

Click Submit to save your changes and to complete the initial setup.

For more information about the optional settings, click Help on the tool-bar.

13. After you click Submit, these events occur:

- a. The switch is configured and exits Express Setup mode.
- b. The browser displays a warning message, instructing the user to clear browser cookies.

- c. Typically, connectivity between the computer and the switch is lost because the configured switch IP address is in a different subnet from the IP address on the computer.
- d. If you changed the Management Interface Vlan ID, then after pressing submit, all Ethernet interfaces on the IE 1000 are now members of this new vlan. This is to enable the connection to the network.

14. Remove the PC and connect the switch to the network as configured in step 12.

Note: After power cycling, the IE 1000 will not act as DHCP server. DHCP Server behavior is special to Express Setup. to reconnect to the IE 1000 after the power cycle you will need to A) configure a static IP Address on your PC that is in the same subnet as the IP Address you just assigned, or B) connect to the new IP Address of the IE 1000 from the network.

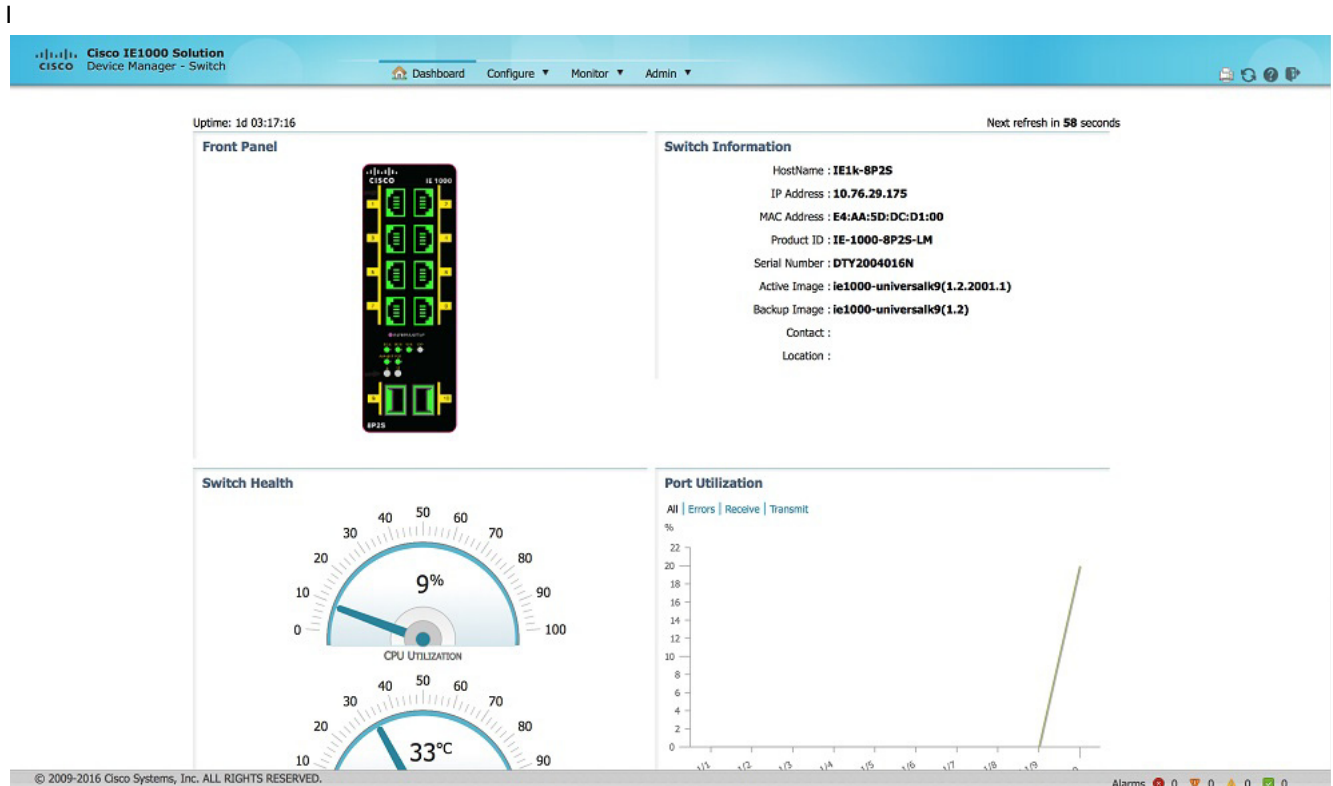

15. You can now manage the switch by using the Device Manager. See the “Managing the Switch” section on page 9 for information about configuring and managing the switch.

You can display Device Manager by following these steps:

- a. Start a web browser on your computer.
- b. Enter the switch **IP address**, **username**, and **password** in the web browser, and press Enter. The Device Manager page appears.

Troubleshooting:

If the Device Manager page does not appear:

- Ping the IP address of device from PC where browser is getting launched. If not check Computer's network connectivity.
- Confirm that the port LED for the switch port connected to your network is green.

- Confirm that the computer that you are using to access the switch has network connectivity by connecting it to a well known web server in your network. If there is no network connection, troubleshoot the network settings on the computer.
- Make sure that the switch IP address in the browser is correct.
- If the switch IP address in the browser is correct, the switch port LED is green, and the computer has network connectivity, continue troubleshooting by reconnecting the computer to the switch. Configure a static IP address on the computer that is in the same subnet as the switch IP address.
- When the LED on the switch port connected to the computer is green, reenter the switch IP address in a web browser to display the Device Manager. When Device Manager appears, you can continue with the switch configuration.



Troubleshooting

This chapter provides these topics for troubleshooting problems:

- [Diagnosing Problems, page 33](#)
- [Finding the Switch Serial Number, page 36](#)

Diagnosing Problems

The switch LEDs provide troubleshooting information about the switch. They show boot fast failures, port-connectivity problems, and overall switch performance. You can also get statistics from Device Manager.

Switch LEDs

Look at the port LEDs information when troubleshooting the switch. See [LEDs, page 6](#) for a description of the LED colors and their meanings.

Switch Connections

Bad or Damaged Cable

Always examine the cable for marginal damage or failure. A cable might be just good enough to connect at the physical layer, but it could corrupt packets as a result of subtle damage to the wiring or connectors. You can identify this problem because the port has many packet errors or it constantly flaps (loses and regains link).

- Exchange the copper or fiber-optic cable with a known good cable.
- Look for broken or missing pins on cable connectors.
- Rule out any bad patch panel connections or media convertors between the source and the destination. If possible, bypass the patch panel, or eliminate media convertors (fiber-optic-to-copper).
- Try the cable in another port to see if the problem follows the cable.

Ethernet and Fiber-Optic Cables

Make sure that you have the correct cable:

- For Ethernet, use Category 3 copper cable for 10 Mb/s UTP connections. Use either Category 5, Category 5e, or Category 6 UTP for 10/100 Mb/s, and PoE connections.
- Verify that you have the correct fiber-optic cable for the distance and port type. Make sure that the connected device ports match and use the same type encoding, optical frequency, and fiber type.
- Determine if a copper crossover cable was used when a straight-through was required or the reverse.

Link Status

Verify that both sides have a link. A broken wire or a shutdown port can cause one side to show a link even though the other side does not have a link.

A port LED that is on does not guarantee that the cable is functional. It might have encountered physical stress, causing it to function at a marginal level. If the port LED does not turn on:

- Connect the cable from the switch to a known good device.
- Make sure that both ends of the cable are connected to the correct ports.
- Verify that both devices have power.
- Verify that you are using the correct cable type. See [Cables and Adapters, page 38](#) for information.
- Look for loose connections. Sometimes a cable appears to be seated but is not. Disconnect the cable, and then reconnect it.

10/100 Port Connections

If a port appears to malfunction:

- Verify the status of all ports by checking the LEDs. For more information, see [Switch LEDs, page 33](#).
- Verify the cable type. See [Cable and Connectors, page 37](#).

SFP Module

Use only Cisco SFP modules. Each Cisco module has an internal serial EEPROM that is encoded with security information. This encoding verifies that the module meets the requirements for the switch.

- Inspect the SFP module. Exchange the suspect module with a known good module.
- Verify that the module is supported on this platform. (The switch release notes on Cisco.com list the SFP modules that the switch supports.)
- Make sure that all fiber-optic connections are clean and securely connected.

Interface Settings

Verify that the interface is not disabled or powered off. If an interface is manually shut down on either side of the link, it does not come up until you reenables the interface. If needed, reenables the interface.

Ping End Device

Ping from a laptop first, and then work your way back port by port, interface by interface, trunk by trunk, until you find the source of the connectivity issue. Make sure that each switch can identify the end device MAC address in its Content-Addressable Memory (CAM) table.

Spanning Tree Loops

STP loops can cause serious performance issues that look like port or interface problems.

A unidirectional link can cause loops. It occurs when the traffic sent by the switch is received by the neighbor, but the traffic from the neighbor is not received by the switch. A broken cable, other cabling problems, or a port issue can cause this one-way communication.

Switch Performance

Speed, Duplex, and Autonegotiation

Port statistics that show a large amount of alignment errors, frame check sequence (FCS), or late-collisions errors, might mean a speed or duplex mismatch.

A common issue occurs when duplex and speed settings are mismatched between two switches, between a switch and a router, or between the switch and a workstation or server. Mismatches can happen when manually setting the speed and duplex or from autonegotiation issues between the two devices.

To maximize switch performance and to ensure a link, follow one of these guidelines when changing the duplex or the speed settings.

- Let both ports autonegotiate both speed and duplex.
- Manually set the speed and duplex parameters for the interfaces on both ends of the connection.
- If a remote device does not autonegotiate, use the same duplex settings on the two ports. The speed parameter adjusts itself even if the connected port does not autonegotiate.

Autonegotiation and Network Interface Cards

Problems sometimes occur between the switch and third-party network interface cards (NICs). By default, the switch ports and interfaces autonegotiate. Laptops or other devices are commonly set to autonegotiate, yet sometimes issues occur.

To troubleshoot autonegotiation problems, try manually setting both sides of the connection. If this does not solve the problem, there could be a problem with the firmware or software on the NIC. You can resolve this by upgrading the NIC driver to the latest version.

Cabling Distance

If the port statistics show excessive FCS, late-collision, or alignment errors, verify that the cable distance from the switch to the connected device meets the recommended guidelines. See [Cables and Adapters, page 38](#).

Resetting the Switch

These are reasons why you might want to reset the switch to the factory default settings:

- You installed the switch in your network and cannot connect to it because you assigned the wrong IP address.
- You want to reset the password on the switch.

Note: Resetting the switch deletes the configuration and reboots the switch.

To reset the switch:

1. Press and hold the Express Setup button (recessed behind a small hole in the faceplate) for about 15–20 seconds with a paper clip or similar object. The switch reboots. The system LED turns green after the switch completes rebooting.
2. Press the Express Setup button again for 3 seconds. Fa 1/1port blinks green.

The switch now behaves like an unconfigured switch.

Finding the Switch Serial Number

If you contact Cisco Technical Assistance, you need to know the serial number of your switch. The serial number is on the compliance label on the right-hand side of the switch. See [Figure 1 on page 36](#).

Figure 1 Serial Number Location for the Cisco IE 1000 Switches





Cable and Connectors

- [Connector Specifications, page 37](#)
- [Cables and Adapters, page 38](#)

Connector Specifications

- [10/100 Ports, page 37](#)
- [SFP Module Connectors, page 37](#)
- [Cables and Adapters, page 38](#)

10/100 Ports

The 10/100 Ethernet ports on the switches use RJ-45 connectors. [Figure 210/100 Port Pinouts, page 37](#) shows the pinouts.

Figure 2 10/100 Port Pinouts

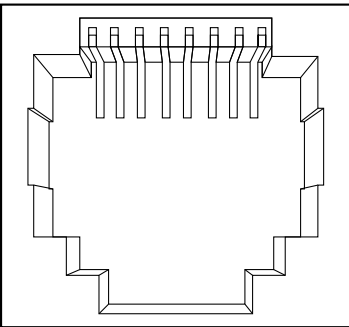
Pin	Label	1	2	3	4	5	6	7	8
1	RD+								
2	RD-								
3	TD+								
4	NC								
5	NC								
6	TD-								
7	NC								
8	NC								

Note: For the two models of IE 1000 switch that support PoE, connector pins 4 and 5 supply +48 VDC and pins 7 and 8 are the DC voltage return lines.

SFP Module Connectors

[Figure 3Fiber-Optic SFP Module LC Connector, page 38](#) shows a MT-RJ style connector that is used with the SFP Module slots. It is a fiber-optic cable connector.

Figure 3 Fiber-Optic SFP Module LC Connector

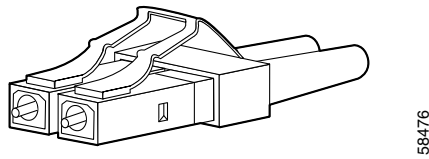

Warning: Invisible laser radiation may be emitted from disconnected fibers or connectors. Do not stare into beams or view directly with optical instruments. Statement 1051

Cables and Adapters

- [SFP Module Cables, page 38](#)
- [Cable Pinouts, page 38](#)

SFP Module Cables

Each port must match the wave-length specifications on each end of the cable, and for reliable communications, the cable must not exceed the allowable length.

Notes

- The maximum operating temperature of the switch varies depending on the type of SFP module that you use.
- Modal bandwidth applies only to multimode fiber.
- A mode-field diameter/cladding diameter = 9 micrometers/125 micrometers.
- A mode-conditioning patch cord is required when using 1000BASE-LX/LH SFP modules, MMF, and a short link distance. Using an ordinary patch cord can cause transceiver saturation, resulting in an elevated bit error rate (BER). When using the LX/LH SFP module with 62.5-micron diameter MMF, you must also install a mode-conditioning patch cord between the SFP module and the MMF cable on both the sending and receiving ends of the link. The mode-conditioning patch cord is required for link distances greater than 984 feet (300 m).
- 1000BASE-ZX SFP modules can send data up to 62 miles (100 km) by using dispersion-shifted SMF or low-attenuation SMF. The distance depends on the fiber quality, the number of splices, and the connectors.
- When the fiber-optic cable span is less than 15.43 miles (25 km), insert a 5-decibel (dB) or 10-dB inline optical attenuator between the fiber-optic cable plant and the receiving port on the 1000BASE-ZX SFP module.

Cable Pinouts

Figure 4 Two Twisted-Pair Straight-Through Cable Schematic for 10/100 Ports

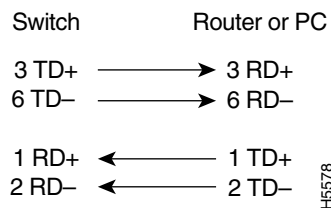

Figure 5 Two Twisted-Pair Crossover Cable Schematic for 10/100 Ports

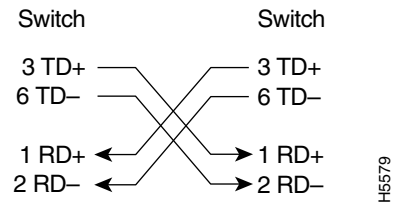
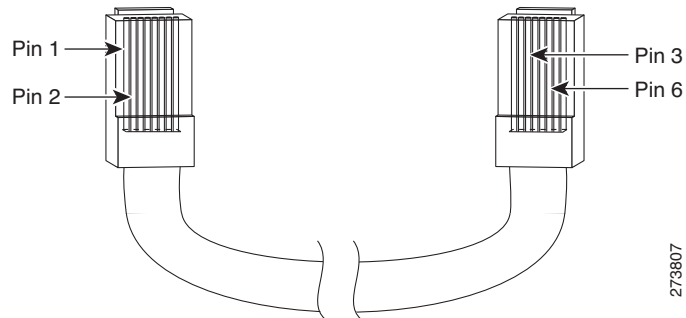

Figure 6 Identifying a Crossover Cable





Hazardous Location Installation Information

This appendix provides hazardous location installation information for the Cisco IE 1000 switches.

Hazardous Area Installation Warnings

Warning: Before working on equipment that is connected to power lines, remove jewelry (including rings, necklaces, and watches). Metal objects will heat up when connected to power and ground and can cause serious burns or weld the metal object to the terminals. Statement 43

Warning: Exposure to some chemicals could degrade the sealing properties of materials used in the sealed relay device. Statement 381

Warning: Failure to securely tighten the captive screws can result in an electrical arc if the connector is accidentally removed. Statement 397

Warning: Do not work on the system or connect or disconnect cables during periods of lightning activity. Statement 1001

Warning: Before performing any of the following procedures, ensure that power is removed from the DC circuit. Statement 1003

Warning: Read the installation instructions before you connect the system to its power source. Statement 1004

Warning: This unit is intended for installation in restricted access areas. A restricted access area can be accessed only through the use of a special tool, lock and key, or other means of security. Statement 1017

Warning: This equipment must be grounded. Never defeat the ground conductor or operate the equipment in the absence of a suitably installed ground conductor. Contact the appropriate electrical inspection authority or an electrician if you are uncertain that suitable grounding is available. Statement 1024

Warning: This unit might have more than one power supply connection. All connections must be removed to de-energize the unit. Statement 1028

Warning: Only trained and qualified personnel should be allowed to install, replace, or service this equipment. Statement 1030

Warning: Ultimate disposal of this product should be handled according to all national laws and regulations. Statement 1040

Warning: For connections outside the building where the equipment is installed, the following ports must be connected through an approved network termination unit with integral circuit protection.
10/100 Ethernet Statement 1044

Warning: To prevent the system from overheating, do not operate it in an area that exceeds the maximum recommended ambient temperature of:
158° F (70° C) for POE units, and 140° F (60° C) for Non-POE units. Statement 1047

Warning: When you connect or disconnect the power and/or alarm connector with power applied, an electrical arc can occur. This could cause an explosion in hazardous area installations. Be sure that all power is removed from the switch and any other circuits. Be sure that power cannot be accidentally turned on or verify that the area is nonhazardous before proceeding. Statement 1058

Warning: In switch installations in a hazardous location, the DC power source could be located away from the vicinity of the switch. Before performing any of the following procedures, locate the DC circuit to ensure that the power is removed and cannot be turned on accidentally, or verify that the area is nonhazardous before proceeding. Statement 1059

Warning: This equipment is supplied as “open type” equipment. It must be mounted within an enclosure that is suitably designed for those specific environmental conditions that will be present and appropriately designed to prevent personal injury resulting from accessibility to live parts. The interior of the enclosure must be accessible only by the use of a tool.

The enclosure must meet IP 54 or NEMA type 4 minimum enclosure rating standards. Statement 1063

Warning: When used in a Class I, Division 2, hazardous location, this equipment must be mounted in a suitable enclosure with proper wiring method, for all power, input and output wiring, that complies with the governing electrical codes and in accordance with the authority having jurisdiction over Class I, Division 2 installations. Statement 1066

Warning: Use twisted-pair supply wires suitable for 86° F (30° C) above surrounding ambient temperature outside the enclosure. Statement 1067

Warning: This equipment is intended for use in a Pollution Degree 2 industrial environment, in overvoltage Category II applications (as defined in IEC publication 60664-1), and at altitudes up to 2000 meters without derating. Statement 1068

Warning: Do not connect or disconnect cables to the ports while power is applied to the switch or any device on the network because an electrical arc can occur. This could cause an explosion in hazardous location installations. Be sure that power is removed from the switch and cannot be accidentally be turned on, or verify that the area is nonhazardous before proceeding. Statement 1070

Warning: Installation of the equipment must comply with local and national electrical codes. Statement 1074

Warning: If you connect or disconnect the console cable with power applied to the switch or any device on the network, an electrical arc can occur. This could cause an explosion in hazardous location installations. Be sure that power is removed or the area is nonhazardous before proceeding. Statement 1080

Warning: Explosion Hazard—Do not connect or disconnect wiring while the field-side power is on; an electrical arc can occur. This could cause an explosion in hazardous location installations. Be sure that power is removed or that the area is nonhazardous before proceeding. Statement 1081

Warning: Explosion Hazard—The area must be known to be nonhazardous before installing, servicing, or replacing the unit. Statement 1082

Warning: Explosion Hazard—Substitution of components may impair suitability for Class I, Division 2/Zone 2. Statement 1083

Warning: Do not insert and remove SFP modules while power is on; an electrical arc can occur. This could cause an explosion in hazardous location installations. Be sure that power is removed or the area is nonhazardous before proceeding. Statement 1087

Caution: This equipment is only suitable for use in Class I, Division 2, Groups A, B, C, D, or nonhazardous locations.

Caution: When installed in a Class I, Div/Zone 2 hazardous location environment, this equipment must be installed in a min. IP54, ATEX certified enclosure.

Caution: When installed in a Class I, Div/Zone 2 hazardous location environment, this equipment must be installed in a pollution degree 2 environment per IEC 60664-1)

Caution: The device is designed to mount on a DIN rail that conforms to Standard EN50022.

Caution: This equipment is suitable for use in Class I, Division 2, Groups A, B, C, D, or only nonhazardous locations.

Caution: Airflow around the switch must be unrestricted. To prevent the switch from overheating, there must be the following minimum clearances:

- Top and bottom: 2.0 in. (50.8 mm)

- Sides: 1.0 in. (25.4 mm)

- Front: 2.0 in. (50.8 mm)

Contact your Cisco Technical Assistance Centre (TAC) if tighter spacings are required.

Caution: The device is intended for vertical installations only.

Caution: Ensure the device is not installed in an environment that exceeds the approved ambient temperature range.

Caution: The device is designed to mount on a DIN rail that conforms to Standard EN50022.

North American Hazardous Location Approval

The following information applies when operating this equipment in hazardous locations:

English: Products marked "Class I, Div 2, GP A, B, C, D" are suitable for use in Class I Division 2 Groups A, B, C, D, Hazardous Locations and nonhazardous locations only. Each product is supplied with markings on the rating nameplate indicating the hazardous location temperature code. When combining products within a system, the most adverse temperature code (lowest "T" number) may be used to help determine the overall temperature code of the system. Combinations of equipment in your system are subject to investigation by the local Authority Having Jurisdiction at the time of installation.

Français: Informations sur l'utilisation de cet équipement en environnements dangereux:

Les produits marqués "Class I, Div 2, GP A, B, C, D" ne conviennent qu'à une utilisation en environnements de Classe I Division 2 Groupes A, B, C, D dangereux et non dangereux. Chaque produit est livré avec des marquages sur sa plaque d'identification qui indiquent le code de température pour les environnements dangereux. Lorsque plusieurs produits sont combinés dans un système, le code de température le plus défavorable (code de température le plus faible) peut être utilisé pour déterminer le code de température global du système. Les combinaisons d'équipements dans le système sont sujettes à inspection par les autorités locales qualifiées au moment de l'installation.

EMC Environmental Conditions for Products Installed in the European Union

This section applies to products to be installed in the European Union.

The equipment is intended to operate under the following environmental conditions with respect to EMC:

- A separate defined location under the user's control.
- Earthing and bonding shall meet the requirements of ETS 300 253 or CCITT K27.
- AC-power distribution shall be one of the following types, where applicable: TN-S and TN-C as defined in IEC 364-3.

In addition, if equipment is operated in a domestic environment, interference could occur.

Hazardous Locations Standards

Hazardous location standards for the Cisco IE 1000 switches:

The following standards were used for the hazardous locations approvals and certifications:
ANSI/ASA 12.12.01-2013
CAN/CSA C22.2 No. 60079-0: 11
CAN/CSA C22.2 No. 60079-15:12
CSA C22.2 No. 213-M1987
EN 60079-0:2012+A11:2013
EN 60079-15:2010
IEC 60079-0 6th Edition
IEC 60079-15 4th Edition
UL 60079-0, 5th Ed, 2009-10-21
UL 60079-15, 3rd Ed, 2009-7-17



Technical Specifications

This appendix provides the technical specification for the Cisco IE 1000 switches.

Operating Temperature Specifications

Table 1 on page 45 lists the Operating Temperatures (measured inside enclosure, 1” below switch) for the Cisco IE 1000 switches.

Table 1 Operation Temperature Specification for the Cisco IE 1000 Switches

	Industrial Automation and Hazardous Locations	Substation	Traffic Signal
Enclosure types	Sealed enclosures (No airflow) For example: NEMA4, NEMA4X, NEMA12, NEMA13, IP54, and IP66.	Vented enclosures (Minimum 40 lfm ¹) For example: NEMA1, IP20, and IP21.	Fan or blower-equipped enclosures (Minimum 200 lfm)
Temperatures (measured inside enclosure, 1” below switch)	POE: -40C to +60C Non-POE: -20C to +60C	POE: -40C to +70C Non-POE: -20C to +70C	POE: -34C to +74C Non-POE: -16C to +74C

1. lfm = linear feet per minute.

Note: The safety certifications apply only to ambient temperatures under 158° F (70° C) measured 1” below switch. However, the Cisco IE 1000 switch can function under the environmental conditions shown in Table 1 on page 45.

Technical Specifications

The technical specifications for the Cisco IE 1000 switches are as follows:

Table 2 Cisco IE 1000 Technical Specifications

Environmental Ranges	
Storage temperature	-40 to 185° F (-40 to 85° C)

Operating temperature ¹ (Measured inside enclosure, 1" below switch)	POE	Non-POE
	-34C to +74C <ul style="list-style-type: none"> -40C to +70C (40 lfm Vented Enclosure Operating) -40C to +60C (Sealed Enclosure Operating) -34C to +74C (Minimum 200 lfm Fan or Blower equipped Enclosure Operating) -40C to +85C (Type Tested to +85C for 16 hours) ²	-16C to +74C <ul style="list-style-type: none"> -20C to +70C (40 lfm Vented Enclosure Operating) -20C to +60C (Sealed Enclosure Operating) -16C to +74C (Minimum 200 lfm Fan or Blower equipped Enclosure Operating) 85C Type Tested for 16 hours
Operating humidity	5 to 95% (noncondensing)	
Operating shock	30 g at 11 ms, and 200 g at 2.11 ms.	
Operating altitude	Up to 13,000 ft (3962 m)	
Storage altitude	Up to 40,000 ft (12,192 m)	
Power Requirements		
DC input voltage	<ul style="list-style-type: none"> Marked range: <ul style="list-style-type: none"> 12-24 VDC (IE1000-4T1T / IE1000-6T2T) 48-54 VDC (IE1000-4P2S / IE1000-8P2S) Maximum operating range: <ul style="list-style-type: none"> 9-32 VDC (IE1000-4T1T / IE1000-6T2T) 48-54 VDC (IE1000-4P2S / IE1000-8P2S) <p>Note:</p> <ul style="list-style-type: none"> The DC-input power supply is an SELV circuit, and it can only be connected to another SELV circuit. 	
Power consumption	<ul style="list-style-type: none"> IE-1000-4T1T-LM -- 3.6W IE-1000-6T2T-LM -- 4.8W IE-1000-4P2S-LM -- 140.4W IE-1000-8P2S-LM -- 205.2W 	
Physical Dimensions		
Weight	IE-1000-4T1T-LM -- 1.10 lb (0.50 kg) IE-1000-6T2T-LM -- 1.25 lb (0.57 kg) IE-1000-4P2S-LM -- 1.70 lb (0.77 kg) IE-1000-8P2S-LM -- 1.85 lb (0.84 kg)	
Dimensions (W x D x H).8 x 5.3 x 5 in. (45.7 x 134 x 127 mm) ³	IE-1000-4T1T-LM -- 1.5 x 4.5 x 5 in. (38.1 x 115 x 127 mm) IE-1000-6T2T-LM -- 1.8 x 4.5 x 5 in. (45.7 x 115 x 127 mm) IE-1000-4P2S-LM -- 1.8 x 5.3 x 5 in. (45.7 x 134 x 127 mm) IE-1000-8P2S-LM -- 1	

- Operating temperatures exceeding 60C are not covered by the product safety certifications and approvals. However, the switch can function in the installations under the environmental conditions listed.
- When using industrial grade SFP modules, maximum operating temperature limits shown in table 1 apply. When using commercial grade SFP modules, maximum system operating temperature limits must be de-rated by 15 deg. C.
- Width includes the cosmetic end-caps. Height does not include the power and alarm connections.

Alarm Ratings

The alarm ratings for the Cisco IE 1000 switches are below.

Table 3 Cisco IE 1000 Alarm Ratings

Alarm Ratings	Specification
Alarm output electrical specification	1.0 A @ 24 VDC or 0.5 A @ 48 VDC

