



Cisco Nexus 5500 Series NX-OS Software Upgrade and Downgrade Guide, Release 7.3(13)N1(1)

First Published: February 13, 2023

This document describes how to upgrade or downgrade Cisco NX-OS software on Cisco Nexus devices and Cisco Nexus Fabric Extenders. Use this document in combination with documents listed in the [“Communications, Services, and Additional Information”](#) section on page 54.

The documentation set for this product strives to use bias-free language. For the purposes of this documentation set, bias-free is defined as language that does not imply discrimination based on age, disability, gender, racial identity, ethnic identity, sexual orientation, socioeconomic status, and intersectionality. Exceptions may be present in the documentation due to language that is hardcoded in the user interfaces of the product software, language used based on RFP documentation, or language that is used by a referenced third-party product.

This document includes these sections:

- [Information About Software Images, page 2](#)
- [Supported Hardware, page 2](#)
- [Upgrade Guidelines, page 3](#)
- [Using the Install All Command, page 5](#)
- [Supported Upgrade and Downgrade Paths, page 6](#)
- [In-Service Software Upgrades, page 8](#)
- [Upgrading Procedures, page 25](#)
- [Disruptive Installation Process, page 37](#)
- [Forcing an Upgrade, page 38](#)
- [Monitoring the Upgrade Status, page 51](#)
- [Downgrading from a Higher Release, page 53](#)
- [Troubleshooting ISSUs and Disruptive Installations, page 53](#)
- [Related Documentation, page 54](#)



Americas Headquarters:
Cisco Systems, Inc., 170 West Tasman Drive, San Jose, CA 95134-1706 USA

- [Communications, Services, and Additional Information, page 54](#)

Information About Software Images

Cisco Nexus devices are shipped with the Cisco NX-OS software preinstalled on the switches. Before upgrading or downgrading from an existing image, you should read through the information in this document to understand the guidelines, prerequisites, and procedures for upgrading the software. For updated information about the Cisco NX-OS software for the Cisco Nexus device, see the [Cisco Nexus 5500 Series Release Notes](#).

The Cisco NX-OS software consists of the kickstart image and the system image. The system image includes the software for the Cisco Nexus device and the Cisco Nexus Fabric Extenders (FEXs) that are connected to the switch. The images contain a major release identifier, a minor release identifier, and a maintenance release identifier, and they can also contain a rebuild identifier, which may also be referred to as a support patch. The following figure shows the version identifiers that are used with a combination of platform-independent and platform-dependent schemes for the Cisco NX-OS software.

Figure 1 Cisco NX-OS Version Identifies

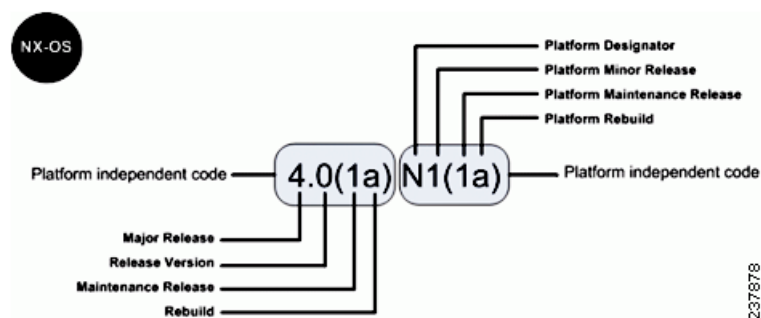

The platform designator is N for the Nexus Series Switches, E for the Nexus 4000 Series Switches, and S for the Nexus 1000 Series Switches. Applicable features, functions, and fixes in the platform-independent code are present in the platform-dependent release.

Supported Hardware

Cisco Nexus devices are shipped with the Cisco NX-OS software preinstalled. Cisco NX-OS upgrades and downgrades are supported on the hardware listed in the following sections:

Cisco Nexus 5500 Series Switches and Associated Expansion Modules

- Cisco Nexus 5596UP
- Cisco Nexus 5596T
- Cisco Nexus 5548UP
- Cisco Nexus 5548P
- N55-M16P
- N55-M16UP

- N55-M8P8FP
- N55-M4Q
- N55-M12T (Supported only on Cisco Nexus 5596T)
- N55-M160L3
- N55-M160L3-V2

Upgrade Guidelines

When upgrading system software, follow these guidelines:

- Configuration changes

You cannot enter global configuration mode during an upgrade. You should save, commit, or discard any active configuration sessions before upgrading or downgrading the Cisco NX-OS software image. The active configuration session is deleted without a warning during a reload.

Use the **show configuration session summary** command to verify that there are no active configuration sessions.

```
switch# show configuration session summary
There are no active configuration sessions
```

For more information on configuration sessions, see the *Cisco Nexus 5600 Series NX-OS System Management Configuration Guide, Release 7.0*.



Note CLI and SNMP configuration change requests are denied during an in-service software upgrade (ISSU).

- Topology—You should make topology changes such as Spanning Tree Protocol (STP) that affect zoning or Fabric Shortest Path First (FSPF) before you perform an upgrade. You should perform module installations or removals only before or after an upgrade.
- Scheduling—You should upgrade when your network is stable and steady. Ensure that everyone who has access to the switch or the network is not configuring the switch or the network during this time. You cannot configure a switch during an upgrade.
- Space—Verify that sufficient space is available in the location where you are copying the images. The internal bootflash requires approximately 200 MB of free space. Also, run the **show system internal flash** command to check that the threshold limit for the filesystems /bootflash/mnt/pss /var/tmp and /var/sysmgr are met.
- Bootflash—During ISSU, bootflash must be free. Bootflash can be busy due to open or active SFTP session, file operation, and so on.
- Hardware—Avoid power interruptions during an installation procedure. Power interruptions can corrupt the software image.
- Connectivity to remote servers

Configure the IPv4 address or IPv6 address for the 10/100/1000 BASE-T Ethernet port connection (interface mgmt0). Ensure that the switch has a route to the remote server. The switch and the remote server must be in the same subnet if you do not have a router to route traffic between subnets.
- Software image—Ensure that the specified system and kickstart images are compatible with each other as follows:

- If the kickstart image is not specified, the switch uses the current running kickstart image.
- If you specify a different system image, ensure that it is compatible with the running kickstart image.
- Retrieve compatible images in one of two ways:
 - Locally—Images are locally available on the switch.
 - Remotely—Images are in a remote location and you specify the destination using the remote server parameters and the filename to be used locally.
- Command—Use the following commands to prepare for and install the new software:
 - Use the **ping** command to verify connectivity to the remote server.
 - Use the **dir** command to verify the required space is available for the image files to be copied.
 - Use the **show install all impact** command to identify the upgrade impact. This command displays information describing the impact of the upgrade on each Fabric Extender such as the current and upgrade-image versions. This command also displays if the upgrade is disruptive or the reason why the upgrade is disruptive, if the Fabric Extender needs to be rebooted, and the reason why it needs to be rebooted.



Note

We recommend that you log in to the console port to begin the upgrade process. In Virtual Port Channel (vPC) topologies, the first upgrade can be performed on either the primary or secondary switch in the topology

- Terminology
 - [Table 1](#) summarizes the terms used in the **install all** command output to verify module and software image compatibility.

Table 1 *install all Commands and Output Terminology*

Term	Definition
bootable	Ability of the module to boot or not boot based on image compatibility.
Impact	Type of software upgrade mechanism—disruptive or nondisruptive.
install-type reset	Resets the module.
sw-reset	Resets the module immediately after a switchover.
rolling	Upgrades each module in sequence.
copy-only	Updates the software for BIOS, loader, or boot ROM.
force	Option to force a disruptive upgrade, even when an ISSU is possible.



Note

If you are upgrading from an earlier release version to Cisco NX-OS Release 7.3.x and later, delete the reserved VLANs 4048 and 4049 before upgrading. In some scenarios, the reserved VLANs could vary based on the range configured in the **system vlan <minimum-vlan> reserve** command. We recommend that you verify the reserved VLANs on the system before upgrading. To view the reserved VLANs, use the **show system vlan reserved** command. If the difference between the reserved VLAN range is 79, then delete the two VLANs after the reserved range. Post the upgrade, the two deleted VLANs will be available in the reserved VLAN range.

Step 1 Verify the reserved VLANs list in the existing image (Cisco NX-OS 7.x or earlier) before upgrading.

```
switch# show running-config | i system

system vlan 2000 reserve          <<<----- reserved vlan range changed to 2000-2079
due to this. default is 3968-4047
switch# show system vlan reserved
system current running vlan reservation: 2000-2079 <<<----
```

Step 2 If the difference between the last and the first reserved VLAN is 79 (similar to the above scenario), delete two VLANs (2080 and 2081) after the last reserved VLAN.

```
switch(config)# no vlan 2080
switch(config)# no vlan 2081
```

Step 3 Upgrade to Cisco NX-OS 7.3(13)N1(1) image and verify the reserved VLAN list after the upgrade. The two deleted VLANs in step 3 will be listed in the reserved VLAN list post the upgrade.

```
switch# show system vlan reserved
system current running vlan reservation: 2000-2081
```

Using the Install All Command

The **install all** command triggers an ISSU on Cisco Nexus devices and Cisco Nexus Fabric Extenders. The following images are upgraded during the installation:

- Kickstart image
- System image
- Fabric Extender image
- System BIOS
- Power sequencers on the system

The **install-all** command provides the following benefits:

- You can upgrade the Cisco Nexus devices and the Cisco Nexus Fabric Extenders using just one command.
- You can receive descriptive information about the intended changes to your system before you continue with the installation. For example, it identifies potential disruptive upgrades.
- You can continue or cancel the upgrade when you see this question (the default is no):
Do you want to continue (y/n) [n] : y
- You can upgrade the Cisco NX-OS software using a nondisruptive procedure, when supported.
- The command automatically checks the image integrity, which includes the running kickstart and system images. The command sets the kickstart and system boot variables.
- The command performs a platform validity check to verify that a wrong image is not used.
- Pressing Ctrl-C gracefully ends the **install all** command. The command sequence completes the update step in progress and returns to the EXEC prompt.
- After entering the **install all** command, if any step in the sequence fails, the upgrade ends.
- The following message appears to warn you about the impact of upgrading the power sequencer:

```
Warning: please do not remove or power off the module at this time.
Note: Power-seq upgrade needs a power-cycle to take into effect.
```



Note After a successful power sequence upgrade, you must switch off the power to the system and then power it up.

- You can force a disruptive upgrade. For information on forcing an upgrade, see [Forcing an Upgrade, page 38](#).

Upgrading the BIOS and Power Sequencer Images

Changes to BIOS and power sequencers are rare; however, when they occur, they are included in the Cisco NX-OS system image, and the BIOS and power sequencer are upgraded. The summary displayed by the installer during the installation process indicates the current version of the BIOS and power sequencer and the target version.



Note After a successful power sequence upgrade, you must switch off the power to the system and then power it up.

Supported Upgrade and Downgrade Paths

Cisco NX-OS supports in-service software upgrades (ISSUs) that allow a Cisco Nexus device and any connected FEXs to be upgraded without any traffic disruption (with a brief control plane disruption). A few conditions have to be met for the system to be upgraded via an ISSU process—the access layer topology should be ISSU compliant, the current and target versions should be ISSU capable, and the network should be stable.

If the conditions required for ISSU are not met or if you intend to downgrade the software version, the installation process will be disruptive. For example, rebooting the Cisco Nexus device and any connected FEX causes a disruption. If Cisco’s virtual port channel (vPC) is configured on Cisco Nexus devices, it is possible to achieve an upgrade/downgrade with very minimal traffic disruption to servers/hosts.

Table 2 Supported Upgrade and Downgrade Paths for Cisco NX-OS Release 7.3(13)N1(1)

Current Cisco NX-OS Release	Upgrade to NX-OS Release 7.3(13)N1(1)	Downgrade from NX-OS Release 7.3(13)N1(1)
7.3(12)N1(1) 7.3(11)N1(1) 7.3(10)N1(1) 7.3(9)N1(1) 7.3(8)N1(1) 7.3(7)N1(1b) 7.3(7)N1(1a) 7.3(6)N1(1) 7.3(5)N1(1) 7.3(4)N1(1) 7.3(3)N1(1) 7.3(2)N1(1) 7.1(5)N1(1) 7.1(4)N1(1)	Non disruptive upgrade (ISSU)	Disruptive downgrade ¹

1. In-service software downgrade (ISSD) from Cisco 7.3(13)N1(1) NX-OS Release 7.3.x to any earlier releases is not supported. All incompatible configurations will be lost in the target release. Performing a downgrade will also result in loss of certain configurations such as unified ports, breakout, and FEX configurations. See [CSCul22703](#) for details. For more information on restoring the configuration, see the “Restoring the Configuration” section in the *Cisco Nexus 5500 Series Software Upgrade and Downgrade Guide, Release 7.3(13)N1(1)*.

**Note**

You cannot upgrade non-disruptively to Cisco NX-OS Release 7.3(13)N1(1) from Cisco NX-OS Release 7.3(7)N1(1) because of the issue due to [CSCvt58479](#).

**Note**

If you want to upgrade from a release on Cisco NX-OS release 7.1 train or earlier, you must first upgrade to Cisco NX-OS release 7.1(4)N1(1) and then to 7.3(13)N1(1). If you want to upgrade from a release on Cisco NX-OS release 7.2 train or earlier, you must first upgrade to Cisco NX-OS release 7.3(2)N1(1) and then to 7.3(13)N1(1).

**Note**

When a switch is connected to Cisco Nexus 2348UPQ, 2348TQ, and 2332TQ Fabric Extender, and you perform a nondisruptive upgrade to Cisco NX-OS Release 7.0(7)N1(1), 7.1(2)N1(1), 7.2(0)N1(1), or 7.3(0)N1(1) and later, then must reload the mentioned FEXs after the nondisruptive upgrade for the [CSCut90356](#) fix to be effective; alternatively, you must do a disruptive upgrade for these releases.

**Note**

If you are performing a nondisruptive upgrade from Cisco NX-OS release 7.0(6)N1(1) to 7.0(7)N1(1) and later release, or from Cisco NX-OS release 7.0(6)N1(1) to a 7.1, 7.2, or 7.3 release, then you must reload the switch for the [CSCur26244](#) fix to be effective; alternatively, you must perform a disruptive upgrade.

**Note**

If you want to upgrade from a release, that is not listed in the “Current Cisco NX-OS Release” column in Table 2 under the “Supported Upgrade and Downgrade Paths for a Cisco NX-OS Release” section to the latest Cisco NX-OS release version, then you must first upgrade to a release that is listed in the “Current Cisco NX-OS Release” column and then to the latest release version.

**Note**

If a supported upgrade or downgrade path is not taken, then certain configurations, especially related to unified ports, Fibre Channel (FC) ports, breakout, and FEX may be lost.

**Note**

Doing a disruptive upgrade between incompatible images will result in loss of certain configurations such as unified ports, breakout, and FEX configurations. See [CSCul22703](#) for details.

**Note**

The Cisco Nexus 5696Q switch cannot be downgraded from Cisco NX-OS release 7.0(4)N1(1). The Cisco Nexus 56128 cannot be downgraded from release 7.0(2)N1(1). The Cisco Nexus 5672 cannot be downgraded from release 7.0(1)N1(1a).

In-Service Software Upgrades

With a single supervisor system, such as the Cisco Nexus device, an ISSU on the Cisco Nexus device causes the supervisor CPU to reset and load the new software version. The control plane is inactive, but the data plane keeps forwarding packets that lead to an upgrade with no service disruption. After the CPU loads the updated version of Cisco NX-OS, the system restores the control plane to a previously known configuration and the runtime state and the data plane are synchronized. Because the data plane keeps forwarding packets while the control plane is upgraded, any servers connected to the Cisco Nexus device access layer should see no traffic disruption.

ISSU and Layer 3

Cisco Nexus devices support Layer 3 functionality. The system cannot be upgraded with the ISSU process (nondisruptive upgrade) when Layer 3 is enabled. You must unconfigure all Layer 3 features, remove the L3 license, and reload the switch, to be have a nondisruptive upgrade with an ISSU.

ISSU Supported Topologies

This section includes the following topics:

- [ISSU Support For Cisco Nexus Fabric Extenders, page 8](#)
- [ISSU Support for vPC Topologies, page 9](#)
- [ISSU Support for vPC Topologies with Fabric Extenders, page 10](#)
- [ISSU Support With FCoE Topologies, page 11](#)
- [Summary of ISSU-Supported Topologies, page 11](#)
- [Summary of ISSU Unsupported Topologies, page 14](#)
- [Management Services After an ISSU, page 18](#)
- [Fibre Channel/FCoE Protocol and Services During an ISSU, page 18](#)
- [Layer-2 Protocols Impact, page 20](#)
- [Ethernet Interfaces on the Switch and the Fabric Extenders, page 20](#)

ISSU Support For Cisco Nexus Fabric Extenders

Cisco Nexus Fabric Extenders act as line cards to Cisco Nexus devices. The Fabric Extenders add flexibility to the data center networking infrastructure by decoupling the physical and logical (Layer 2) topology, reducing the operation expense by lowering management and troubleshooting points, and building a larger Layer 2 fabric that is loop free, with a single layer of switching.

The ISSU process initiated on the Cisco Nexus devices upgrades the entire access layer including the switch and the FEXs that are connected to the switch.

An ISSU first upgrades the switches. Once the switch is operational with the upgraded software, the FEXs are upgraded. The FEX upgrades are done in a rolling fashion, one FEX at a time. This upgrade on the Fabric Extenders is nondisruptive, which is similar to the upgrade of the switch.

The time required for an ISSU to complete depends on the number of FEXs that are connected. You should plan a maintenance window with the total upgrade time in mind. The entire upgrade is nondisruptive and is not expected to cause any outage to connected servers.

ISSU Support for vPC Topologies

An ISSU is completely supported when two switches are paired in a vPC configuration. In a vPC configuration, one switch functions as a primary switch and the other functions as a secondary switch. They both run the complete switching control plane but coordinate forwarding decisions to have optimal forwarding to devices at the other end of the vPC. Additionally, the two devices appear as a single device that supports EtherChannel (static and 802.3ad) and provide simultaneously data forwarding services to that device.

While upgrading devices in a vPC topology, you should start with the switch that is the primary switch. The vPC secondary device should be upgraded after the ISSU process completes successfully on the primary device. The two vPC devices continue their control plane communication during the entire ISSU process (except when the ISSU process resets the CPU of the switch being upgraded).

This example shows how to determine the vPC operational role of the switch:

```
switch-2# show vpc brief
Legend:
          (*) - local vPC is down, forwarding via vPC peer-link

vPC domain id           : 777
Peer status             : peer adjacency formed ok
vPC keep-alive status   : peer is alive
Configuration consistency status : success
Per-vlan consistency status : success
Type-2 consistency status : success
vPC role                : primary
Number of vPCs configured : 139
Peer Gateway           : Disabled
Dual-active excluded VLANs : -
Graceful Consistency Check : Enabled
Auto-recovery status   : Enabled (timeout = 240 seconds)

vPC Peer-link status
-----
id  Port  Status Active vlans
--  ---  -----
1   Po1012 up    1,1001,1009-1029,2000-2019

vPC status
```

You can monitor the status of an ISSU on the primary switch, after the primary switch reloads by using the **show install all status** command.

Any attempt to initiate an upgrade on the vPC peer switch, when an ISSU is in progress on the other switch, is blocked.



Note

During an upgrade, the configuration on peer switches is locked and the vPC state on vPC peer switches is suspended until the upgrade is complete.

Verifying the vPC Status on a Peer Switch During an Upgrade

To view the vPC status, enter the **show vpc** command on a peer switch as follows:

```
switch-2# show vpc
Legend:
          (*) - local vPC is down, forwarding via vPC peer-link

vPC domain id           : 777
Peer status             : peer adjacency formed ok
```

```
vPC keep-alive status           : peer is alive
Configuration consistency status : success
Per-vlan consistency status     : success
Type-2 consistency status      : success
vPC role                        : primary
Number of vPCs configured      : 139
Peer Gateway                    : Disabled
Dual-active excluded VLANs     : -
Graceful Consistency Check     : Enabled
Auto-recovery status           : Enabled (timeout = 240 seconds)
```

```
vPC Peer-link status
-----
id   Port   Status Active vlans
--   -
1    Po1012 up      1,1001,1009-1029,2000-2019
```

```
vPC status
```

The following message is displayed on the vPC peer switch when an ISSU is started on the other switch:

```
switch-2# 2020 Jun 26 10:46:08 switch-2 %$ VDC-1 %$ %VPC-2-VPC_ISSU_START: Peer vPC switch
ISSU start, locking configuration
```

Viewing System Messages on Peer Switches

A keepalive message such as the following may appear on a peer switch during an upgrade:

```
2020 Jun 4 00:09:26 MN5020-4 %$ VDC-1 %$ %VPC-2-PEER_KEEP_ALIVE_RECV_FAIL: In domain
1000, VPC peer keep-alive receive has failed
```

Installation status messages such as the following may appear on peer switches as the primary switch is upgraded.

```
switch-2# 2020 Jun 10 18:27:25 switch%$ VDC-1 %$ %SATCTRL-2-SATCTRL_IMAGE: FEX100 Image
update in progress.
switch-2# 2020 Jun 10 18:32:54 switch%$ VDC-1 %$ %SATCTRL-2-SATCTRL_IMAGE: FEX100 Image
update complete. Install pending
```

ISSU Support for vPC Topologies with Fabric Extenders

An ISSU is supported in vPC topologies that include FEXs that are connected in dual-homed topologies to a parent switch and when the FEX is in a single-homed topology.

To perform a nondisruptive upgrade, in a vPC environment that has FEXs connected to a switch, perform the following steps:

1. Perform a nondisruptive upgrade on the first switch.
2. Check the status of FEXs on the second switch prior to performing a nondisruptive upgrade on it. If any of the FEXs are in Active-Active (AA) version mismatch state, shut the corresponding NIF ports of the impacted FEXs.
3. Perform a nondisruptive upgrade on the second switch using the **install all** command.
4. After the upgrade is complete on the second switch, bring up the ports that were shut in the Step 2.



Note

After the upgrade procedure, ensure all the FEX ports are in online state, including the Active-Active version mismatch ports.

**Note**

From Cisco NX-OS Release 7.1(4)N1(1) onwards, during a nondisruptive upgrade, if one or more FEX fails, the install process will display the upgrade failure for the failed FEX, but will continue with the upgrade process for other FEXs.

ISSU Support With FCoE Topologies

ISSUs are supported on access layer switches when Fibre Channel over Ethernet (FCoE) is enabled. You must ensure that the FCoE fabric is stable before initiating an ISSU in this topology.

Summary of ISSU-Supported Topologies

The following figure shows an access switch topology.

Figure 2 Access Switch Topology

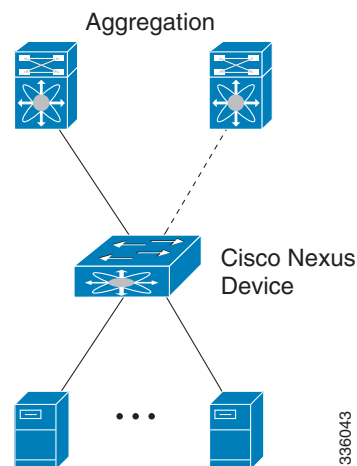

The following figure shows a vPC peering topology.

Figure 3 vPC Peering Topology

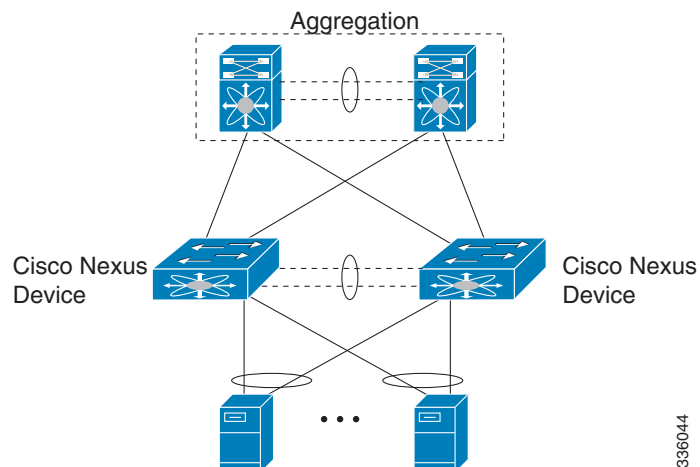

The following figure shows a virtual modular system with static fabric connectivity for FEXs.

Figure 4 *Virtual Modular System with Static Fabric Connectivity for FEXs*

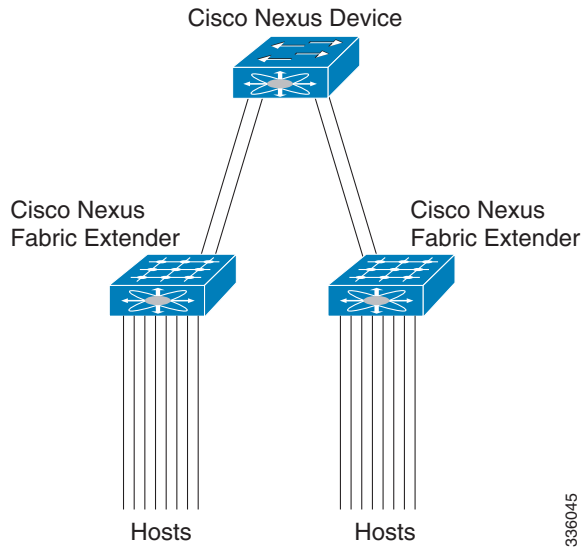

336045

The following figure shows a vertical modular system.

Figure 5 *Virtual Modular System*

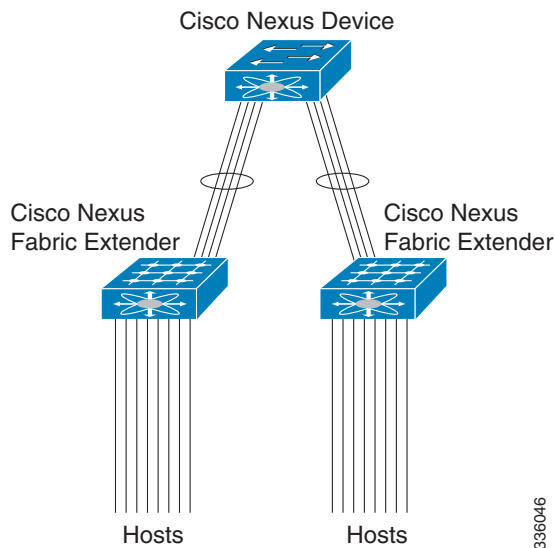

336046

The following figure shows a vPC-peered dual-supervisor virtual modular system with dual-homed FEXs.

Figure 6 *vPC-Peered Dual-Supervisor Virtual Modular System Dual-Homed FEXs*

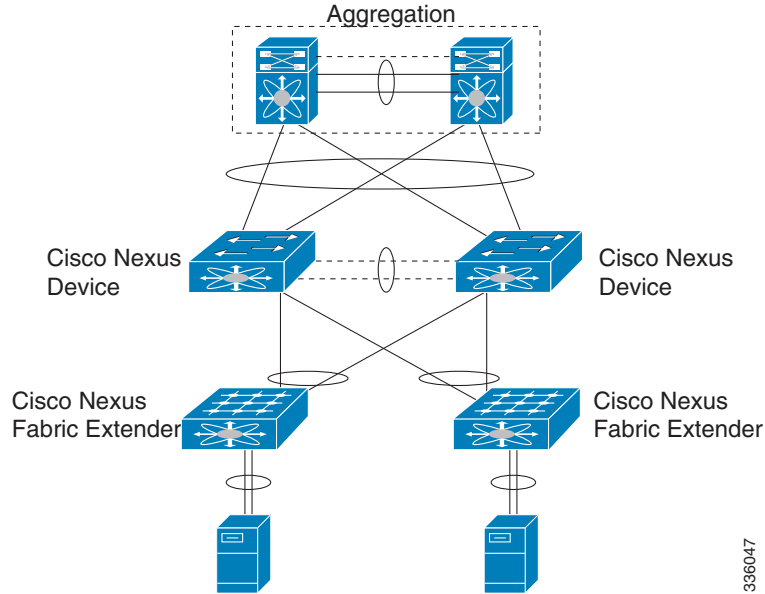

The following figure shows a vPC-peered dual-supervisor virtual modular system with dual-homed and single-homed FEXs.

Figure 7 *vPC-Peered Dual-Supervisor Virtual Modular System Dual-Homed and Single-Homed FEXs*

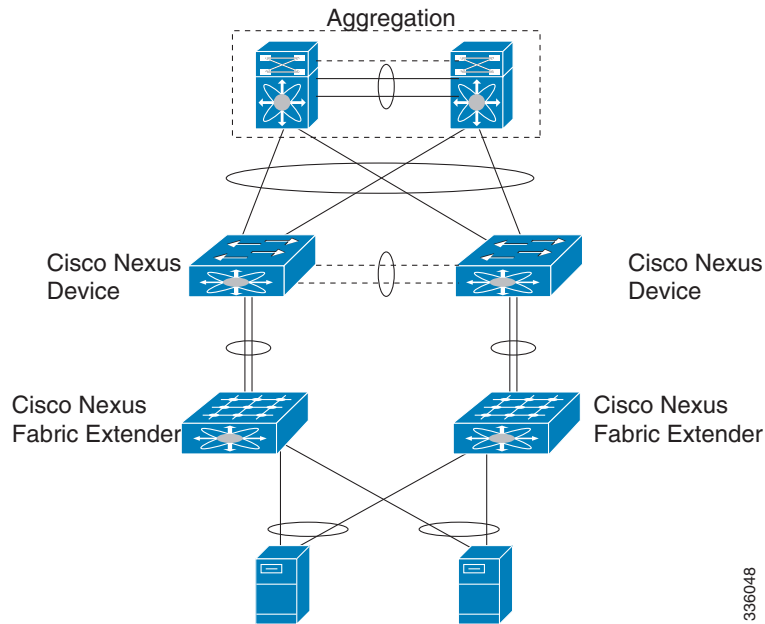

The following figure shows a vPC-peered dual-supervisor virtual modular system with dual-homed FEXs.

Figure 8 vPC Peered Dual-Supervisor Virtual Modular System Dual-Homed FEXs

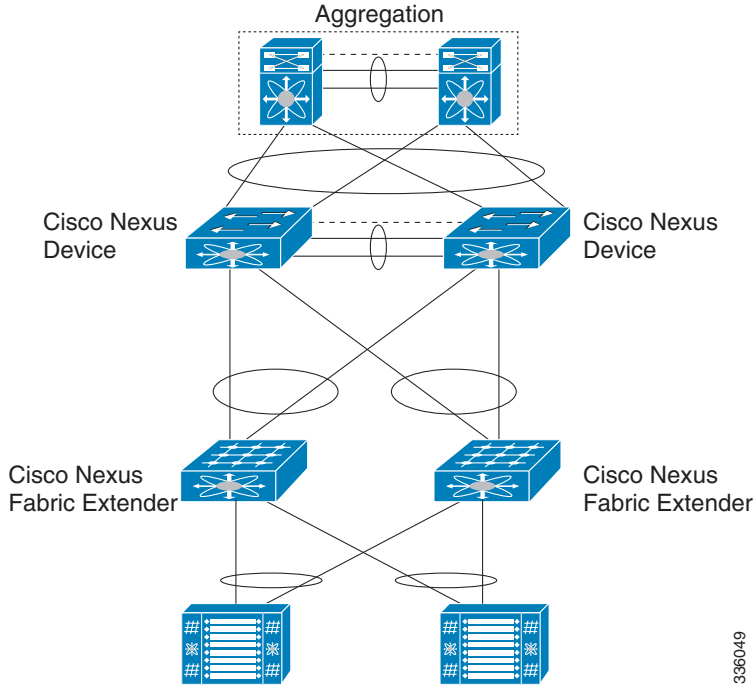

Summary of ISSU Unsupported Topologies

Two important spanning tree-related requirements for a Cisco Nexus device undergoing an ISSU are as follows. Note that a switch undergoing an ISSU has its control plane inactive while the switch is reset and the new software version is loaded. Not having these restrictions could render the network unstable, if there are any unexpected topology changes:

- STP-enabled switches cannot be present downstream to the switch undergoing an ISSU.
- The STP Bridge Assurance feature cannot be configured except on a vPC peer link. Bridge Assurance is enabled by configuring an interface as a spanning-tree port type network.

If the STP conditions are not met, the installation check will indicate that the upgrade would be disruptive. In this case, you can perform an upgrade at a later time after making necessary changes to the topology to meet these conditions or perform a disruptive upgrade.

The following figure shows a Cisco Nexus device that is connected to a blade switch that is running STP.

Figure 9 Connection to a Blade Switch That is Running STP

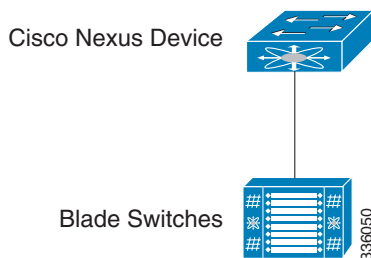

The following figure shows a Cisco Nexus device that is connected to a downstream switch that is running STP.

Figure 10 Connection to a Downstream Switch That is Running STP

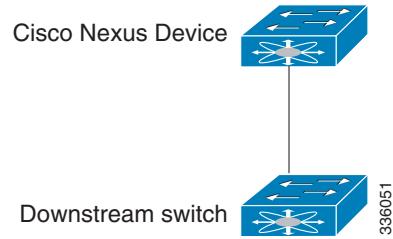

The following figure shows a Cisco Nexus device that is running Bridge Assurance with another switch.

Figure 11 Cisco Nexus Device Running Bridge Assurance with Another Switch

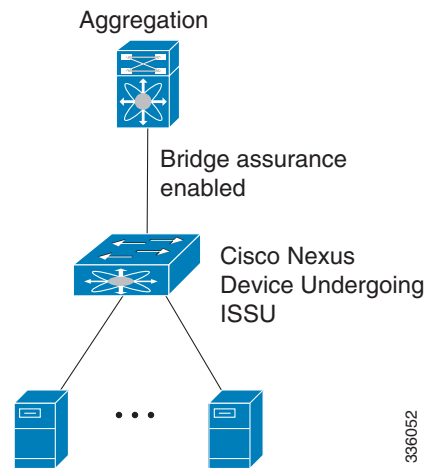

The following figure shows dual-homed FEXs connected to a stub switch.

Figure 12 *Dual-Homed FEXs Connected to a Stub Switch*

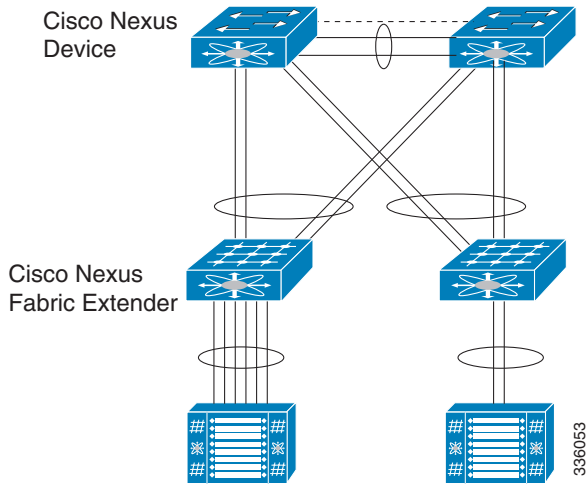

The following figure shows a single-homed FEX that is connected to stub switches.

Figure 13 *Single-Homed FEX Connected to Stub Switches*

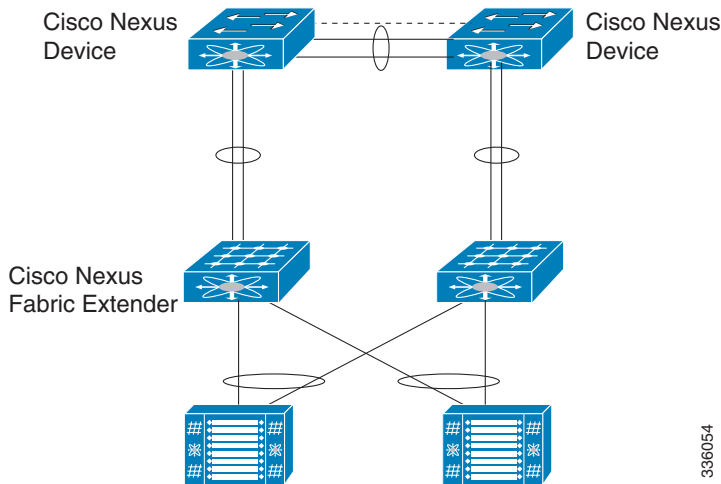

The following figure shows a dual-homed FEX that is connected to stub switches.

Figure 14 *Dual-Homed FEX Connected to Stub Switches*

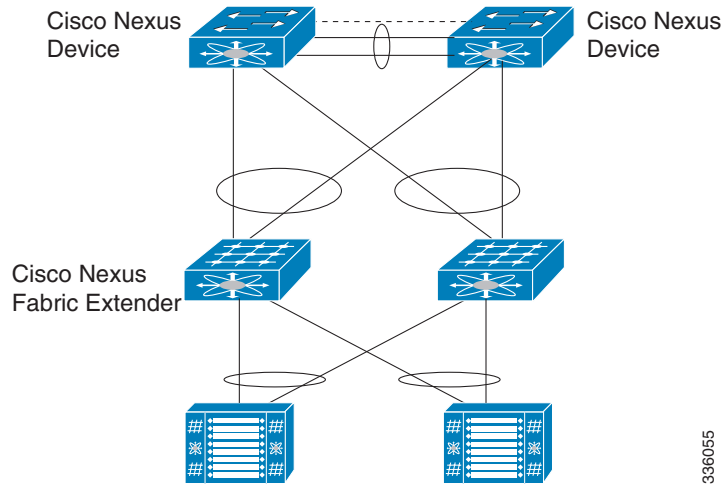

ISSU Prerequisites

Follow all the upgrade guidelines listed in the [“Upgrade Guidelines” section on page 3](#) so that ISSU goes smoothly. Make sure that the network is stable and no changes are made while an ISSU is in progress. In addition, make sure that you check for feature compatibility between the current running release and the target release.

The following figure shows upgrade restrictions.

Figure 15 *Upgrade Restrictions*

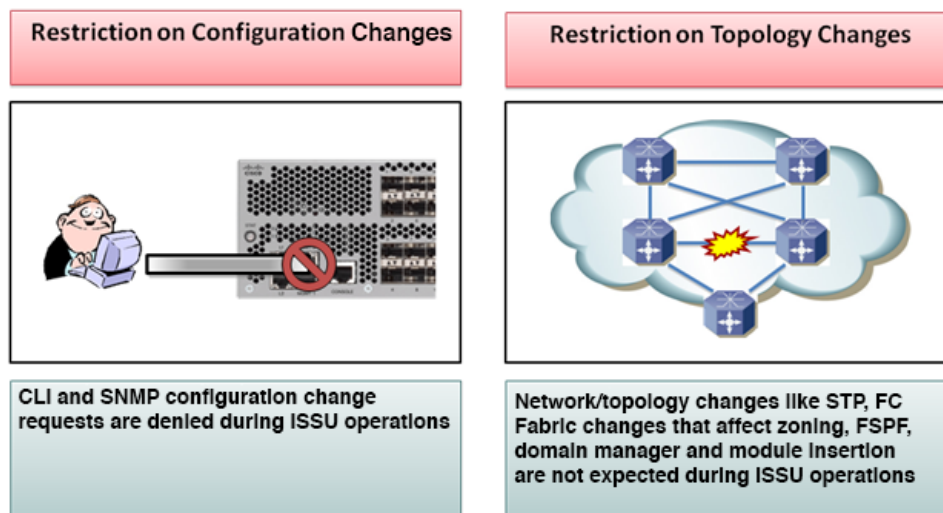

In addition, there are some specific requirements for a nondisruptive upgrade (ISSU).

Topology requirements— A Cisco Nexus device on which an ISSU is being initiated should not be in one of the unsupported topologies listed in the previous figure. No interface should be in a spanning-tree designated forwarding state. Also, bridge assurance should not be configured on any interface of the Cisco Nexus device. vPC peer-link is an exception to these requirements.

Layer 2 requirement— The ISSU process will be aborted if the system has any Link Aggregation Control Protocol (LACP) fast timers configured.

FCoE requirements—Check that the topology is stable for an ISSU to work smoothly. The following is a list of things you must check:

Domain Manager—As part of the installation process, domain manager checks if the fabric is in a stable state. If the fabric is not stable, the installation will abort.

CFS—As part of the installation process, CFS checks if any application (ntp,fsm, rcsn, fctime) is locked. If any application is holding a CFS lock, the installation will abort.

Zone Server— The installation process aborts if a zone merge or zone change request is in progress.

FSPF—As part of the upgrade process, Fabric Shortest Path First (FSPF) verifies if the configured interface dead interval is more than 80 seconds; otherwise, installation will abort.

Management Services After an ISSU

Before the switch is reset for an ISSU, inband and management ports are brought down and are brought back up after the ISSU completes. Services that depend on the inband and management ports are impacted during this time.

Table 3 *Inband and Management Ports Services Impacted During ISSU Reset*

Service	Description
Telnet/SSH	When an ISSU resets the system to load the target Cisco NX-OS version, all Telnet/SSH sessions are disconnected and need to be reestablished after the ISSU completes.
AAA/RADIUS	Applications that leverage the AAA Service (such as login) are disabled during an ISSU. Because all Network Management services are disabled during this time, this behavior is consistent.
HTTP	HTTP sessions to the switch are disconnected during an ISSU reboot. After the reboot, the HTTP is restarted and the switch will accept HTTP sessions.
NTP	NTP sessions to and from the switch are disrupted during an ISSU reboot. After the reboot, NTP session are reestablished based on the saved startup configuration.

Fibre Channel/FCoE Protocol and Services During an ISSU

During an ISSU, the control plane is offline for up to 80 seconds. Any state changes in the network during this time are not processed. Depending on the change, the impact may vary. We recommend that you ensure a stable fabric during an ISSU. See the following table for other ISSU impacts.

Table 4 *ISSU Impact to Fibre Channel and FCoE Services*

Service	Description
Name Server	When a new switch in the fabric is brought up and queries the Name Server on the ISSU switch, the ISSU switch cannot respond and does not receive Nx_port information.
Domain Manager	Domain Manager on a switch undergoing an ISSU does not process any BF/RCF/DIA/RDI caused by topology changes, which might result in traffic disruption in the fabric.
CFS	During an ISSU upgrade, CFS applications on other switches cannot obtain CFS locks on the ISSU switch, which might result in CFS distribution failures until the ISSU completes.
N-Port Virtualization	During an ISSU, the NPV process is down. Any FLOGI/fdisc or logo request from a server fails until the ISSU completes.
Zone Server	<p>During an ISSU, because EPP and merge requests are not processed, the peer switch cannot bring up E and TE ports connected to the ISSU switch until the ISSU completes.</p> <p>A peer switch zone change request is not answered by the switch undergoing an ISSU. Any zone configuration changes on other switches connected to the ISSU switch fails until the ISSU completes.</p>
FSPF	Before the switch reboots for an ISSU, the switch transmits a FSPF hello on all interfaces to prevent neighbor switches from marking routes to the ISSU switch as down. Any topology changes during this time are also not acted upon until the ISSU completes.
EPP	During an ISSU process, EPP messages are not received/transmitted on the ISSU switch. New ports in FCoE port channels are not negotiated until the ISSU completes. Additionally, FC Trunk Mode changes (E port to TE Port and vice versa and the allowed VSAN list) are also not processed.
FCoE NPV Links	When the NPV/FCoE NPV switch is logged into a core switch through an FCoE NPV link, it will punch heartbeats (FIP keepalives - FKA), toward the core switch for its own internal login session and all the host login sessions pinned through this FCoE NPV link. This FKA interval of 8 seconds is less than the ISSU downtime. Set disable-fka on the core switch VFC parameters to ensure that the core switch ignores any FKA events.

Layer-2 Protocols Impact

The following table lists the ISSU impacts to Layer 2 protocols.

Table 5 *ISSU Impact to Layer 2 Protocols*

Protocol	Description
LACP	IEEE 802.3ad provides for the default slow aging timers to be transmitted once every 30 seconds in steady state and to expire after 90 seconds. An ISSU should not impact peers that rely on LACP because the recovery time is less than 90 seconds. Note that a Fast LACP timers (hello=1 sec, dead=3 sec) are not supported with a nondisruptive ISSU.
IGMP	IGMP does not disrupt existing flows of multicast traffic that are already present, but new flows are not learned (and are dropped) until an ISSU completes. New router ports or changes to router ports are not detected during this time.
DCBX and LLDP	DCBX uses LLDP to exchange parameters between peer devices. Because DCBX is a link-local protocol, when the switch undergoes an ISSU, the age time is increased on all ports on the switches and FEXs that are being upgraded. Manual configurations are ignored during this time.
CDP	During an ISSU, the time-to-live value is increased (180 seconds) if it is less than the recommended timeout value. The configuration is ignored if manually specified.
L2MP IS-IS	Before a switch reboots for an ISSU, the switch transmits L2 IS-IS hellos on all interfaces to prevent neighbor switches from marking routes to the ISSU switch as down. Any topology changes during this time are also not acted upon until the ISSU completes.

Ethernet Interfaces on the Switch and the Fabric Extenders

To avoid link down to link up transitions during the control plane outage time, the laser is turned off for administratively up ports that are operationally down. This situation occurs during the ISSU reboot starting state when the switch and the FEX applications stop communicating with each other. After the ISSU reboot and a stateful restart, the laser is turned back on. This action prevents the link state from transitioning from down to up during an ISSU.

Preinstallation Checks

You should do certain sanity checks to ensure that the system is ready for an ISSU and to understand the impact of ISSU:

- Enter the **show incompatibility** command to verify that the target image is feature-wise compatible with the current image.
- Enter the **show logging level** command to ensure that the severity level for all processes is set to 5 or below.
- Enter the **show install all impact** command to identify the upgrade impact.

- Enter the **show fex** command to verify that all the FEXs are online.
- Enter the **show vpc role** command to verify the vPC switch role in a vPC topology.
- Enter the **install all** command to update to the latest Cisco NX-OS software.
- Review the installer impact analysis and choose to continue.

**Note**

The switch might reload at this time and cause a traffic disruption if the upgrade is not an ISSU.

- Monitor the installation progress.
- Verify the upgrade.
- Enter the **show install all status** command to verify the status of the installation

The following table lists the **show** commands that identify the impact or potential problems that may occur when performing an ISSU.

Table 6 Upgrade show Commands

Command	Definition
show incompatibility system	Displays incompatible configurations on the current system that will impact the upgrade version.
show logging level	Displays the facility logging severity level configuration. Logging levels for all processes must be set at 5 or below when performing an ISSU. Processes with a logging level greater than 5 are not displayed when you enter the show install all impact command.
show install all impact	Displays information that describes the impact of the upgrade on each Fabric Extender including the current and upgrade-image versions. This command also displays if the upgrade is disruptive or not and if the Fabric Extender needs to be rebooted and the reason why.
show spanning-tree issu-impact	Displays the spanning-tree configuration and whether or not there are potential STP issues.
show lacp issu-impact	Displays the port priority information and whether or not there are potential issues.
show fcoe-npv issu-impact	Checks whether disable-fka is set on any of the FCoE NPV (VNP) ports as a pre-ISSU check.

You can also perform the following tasks to identify potential problems before they occur:

- Ensure that you have enough space to store the images on bootflash:
- Display incompatible configurations on the current system that will impact the upgrade version.

```
switch# show incompatibility system bootflash:n5500-uk9.7.3.3.N1.1.bin
No incompatible configurations
```

- Display the status of FEXs connected to the system.

```
switch# show fex
  FEX          FEX          FEX          FEX
Number  Description      State      Model        Serial
```

```
-----
100      FEX0100      Online      N2K-C2224TP-1GE  JAF1427BQME
101      FEX0101      Online      N2K-C2224TP-1GE  JAF1427BQMK
```

- Display the STP configuration and whether potential STP issues exist.

```
switch# show spanning-tree issu-impact
```

For ISSU to Proceed, Check the Following Criteria :

1. No Topology change must be active in any STP instance
2. Bridge assurance(BA) should not be active on any port (except MCT)
3. There should not be any Non Edge Designated Forwarding port (except MCT)
4. ISSU criteria must be met on the VPC Peer Switch as well

Following are the statistics on this switch

```
No Active Topology change Found!
Criteria 1 PASSED !!
```

```
No Ports with BA Enabled Found!
Criteria 2 PASSED!!
```

```
No Non-Edge Designated Forwarding Ports Found!
Criteria 3 PASSED !!
```

ISSU Can Proceed! Check Peer Switch.

Use the show lacp issu-impact command to display if any port or a peer switch is configured in rate fast mode.

- Verify that ISSU is nondisruptive. By displaying the information about the impact of the upgrade on each FEX including details such as upgrade image versions. This command also displays if the upgrade is disruptive/nondisruptive and the reason why.

```
switch# show install all impact kickstart bootflash:n5500-uk9-kickstart.7.3.8.N1.1.bin
system bootflash:n5500-uk9.7.3.8.N1.1.bin
```

```
Verifying image bootflash:/n5500-uk9-kickstart.7.3.8.N1.1.bin for boot variable
"kickstart".
[#####] 100% -- SUCCESS
```

```
Verifying image bootflash:/n5500-uk9.7.3.8.N1.1.bin for boot variable "system".
[#####] 100% -- SUCCESS
```

Verifying image type.

```
[##### ] 50%2020 Jun 10 11:38:12 5672-22 %$ VDC-1 %$
%SATCTRL-FEX114-2-SOHMS_ENV_ERROR: FEX-114 System Fan access failure on Fan: 1
2020 Jun 10 11:38:12 5672-22 %$ VDC-1 %$ last message repeated 2 times
2020 Jun 10 11:38:12 5672-22 %$ VDC-1 %$ %SATCTRL-FEX114-2-SOHMS_ENV_ERROR: FEX-114 System
Fan access failure on Fan: 3
2020 Jun 10 11:38:12 5672-22 %$ VDC-1 %$ %SATCTRL-FEX114-2-SOHMS_ENV_ERROR: FEX-114 System
Fan access failure on Fan: 2
2020 Jun 10 11:38:12 5672-22 %$ VDC-1 %$ last message repeated 1 time
2020 Jun 10 11:38:12 5672-22 %$ VDC-1 %$ %SATCTRL-FEX114-2-SOHMS_ENV_ERROR: FEX-114 System
Fan access failure on Fan: 1
2020 Jun 10 11:38:12 5672-22 %$ VDC-1 %$ %SATCTRL-FEX114-2-SOHMS_DIAG_ERROR: FEX-114
System minor alarm on fans in fan tray 3
2020 Jun 10 11:38:54 5672-22 %$ VDC-1 %$ %SATCTRL-FEX114-2-SOHMS_ENV_ERROR: FEX-114
initiating shutting down in 60s due to fan failure
2020 Jun 10 11:38:55 5672-22 %$ VDC-1 %$ %SATCTRL-FEX114-2-SOHMS_ENV_ERROR: FEX-114
shutdown aborted
2020 Jun 10 11:38:55 5672-22 %$ VDC-1 %$ %SATCTRL-FEX114-2-SOHMS_DIAG_ERROR: FEX-114
Recovered: System minor alarm on fans in fan tray 2
```

```

2020 Jun 10 11:38:55 5672-22 %$ VDC-1 %$ %SATCTRL-FEX114-2-SOHMS_DIAG_ERROR: FEX-114
System minor alarm on fans in fan tray 2
2020 Jun 10 11:38:56 5672-22 %$ VDC-1 %$ %SATCTRL-FEX114-2-SOHMS_DIAG_ERROR: FEX-114
Recovered: System minor alarm on fans in fan tray 3
[#####] 50%2020 Jun 10 11:40:59 5672-22 %$ VDC-1 %$
%SATCTRL-FEX114-2-SOHMS_ENV_ERROR: FEX-114 initiating shutting down in 60s due to fan
failure
2020 Jun 10 11:41:00 5672-22 %$ VDC-1 %$ %SATCTRL-FEX114-2-SOHMS_ENV_ERROR: FEX-114
shutdown aborted
2020 Jun 10 11:41:00 5672-22 %$ VDC-1 %$ %SATCTRL-FEX114-2-SOHMS_ENV_ERROR: FEX-114 System
Fan access failure on Fan: 2
2020 Jun 10 11:41:00 5672-22 %$ VDC-1 %$ %SATCTRL-FEX114-2-SOHMS_ENV_ERROR: FEX-114 System
Fan access failure on Fan: 1
2020 Jun 10 11:41:00 5672-22 %$ VDC-1 %$ last message repeated 1 time
2020 Jun 10 11:41:00 5672-22 %$ VDC-1 %$ %SATCTRL-FEX114-2-SOHMS_ENV_ERROR: FEX-114 System
Fan access failure on Fan: 3
2020 Jun 10 11:41:00 5672-22 %$ VDC-1 %$ last message repeated 1 time
2020 Jun 10 11:41:00 5672-22 %$ VDC-1 %$ %SATCTRL-FEX114-2-SOHMS_ENV_ERROR: FEX-114 System
Fan access failure on Fan: 2
2020 Jun 10 11:41:00 5672-22 %$ VDC-1 %$ %SATCTRL-FEX114-2-SOHMS_ENV_ERROR: FEX-114 System
Fan access failure on Fan: 1
2020 Jun 10 11:41:00 5672-22 %$ VDC-1 %$ %SATCTRL-FEX114-2-SOHMS_DIAG_ERROR: FEX-114
System minor alarm on fans in fan tray 2
2020 Jun 10 11:41:00 5672-22 %$ VDC-1 %$ %SATCTRL-FEX114-2-SOHMS_DIAG_ERROR: FEX-114
Recovered: System minor alarm on fans in fan tray 1
[#####] 100% -- SUCCESS

Extracting "system" version from image bootflash:/n5500-uk9.7.3.8.N1.1.bin.
[#####] 100% -- SUCCESS

Extracting "kickstart" version from image bootflash:/n5500-uk9-kickstart.7.3.8.N1.1.bin.
[#####] 100% -- SUCCESS

Extracting "bios" version from image bootflash:/n5500-uk9.7.3.8.N1.1.bin.
[#####] 100% -- SUCCESS

Extracting "fex3" version from image bootflash:/n5500-uk9.7.3.8.N1.1.bin.
[#####] 100% -- SUCCESS

Extracting "fexth" version from image bootflash:/n5500-uk9.7.3.8.N1.1.bin.
[#####] 100% -- SUCCESS

Extracting "fex4" version from image bootflash:/n5500-uk9.7.3.8.N1.1.bin.
[#####] 100% -- SUCCESS

Performing module support checks.
[#####] 100% -- SUCCESS

Notifying services about system upgrade.
[#####] 100% -- SUCCESS

```

Compatibility check is done:

Module	bootable	Impact	Install-type	Reason
1	yes	non-disruptive	reset	
101	yes	non-disruptive	rolling	
102	yes	non-disruptive	rolling	
103	yes	non-disruptive	rolling	
104	yes	non-disruptive	rolling	
105	yes	non-disruptive	rolling	
106	yes	non-disruptive	rolling	
107	yes	non-disruptive	rolling	

108	yes	non-disruptive	rolling
109	yes	non-disruptive	rolling
110	yes	non-disruptive	rolling
111	yes	non-disruptive	rolling
112	yes	non-disruptive	rolling
113	yes	non-disruptive	rolling
114	yes	non-disruptive	rolling
115	yes	non-disruptive	rolling
116	yes	non-disruptive	rolling
117	yes	non-disruptive	rolling
118	yes	non-disruptive	rolling
119	yes	non-disruptive	rolling
120	yes	non-disruptive	rolling
121	yes	non-disruptive	rolling
122	yes	non-disruptive	rolling
124	yes	non-disruptive	rolling

Images will be upgraded according to following table:

Module	Image	Running-Version	New-Version	Upg-Required
1	system	7.1(5)N1(1)	7.3(13)N1(1)	yes
1	kickstart	7.1(5)N1(1)	7.3(13)N1(1)	yes
1	bios	v2.1.7(06/16/2020)	v2.1.7(06/16/2020)	no
1	power-seq	v4.0	v4.0	no
1	fabric-power-seq	v4.0	v4.0	no
101	fex3	7.1(5)N1(1)	7.3(13)N1(1)	yes
102	fex3	7.1(5)N1(1)	7.3(13)N1(1)	yes
103	fexth	7.1(5)N1(1)	7.3(13)N1(1)	yes
104	fexth	7.1(5)N1(1)	7.3(13)N1(1)	yes
105	fexth	7.1(5)N1(1)	7.3(13)N1(1)	yes
106	fexth	7.1(5)N1(1)	7.3(13)N1(1)	yes
107	fexth	7.1(5)N1(1)	7.3(13)N1(1)	yes
108	fexth	7.1(5)N1(1)	7.3(13)N1(1)	yes
109	fexth	7.1(5)N1(1)	7.3(13)N1(1)	yes
110	fexth	7.1(5)N1(1)	7.3(13)N1(1)	yes
111	fexth	7.1(5)N1(1)	7.3(13)N1(1)	yes
112	fexth	7.1(5)N1(1)	7.3(13)N1(1)	yes
113	fex4	7.1(5)N1(1)	7.3(13)N1(1)	yes
114	fex4	7.1(5)N1(1)	7.3(13)N1(1)	yes
115	fex4	7.1(5)N1(1)	7.3(13)N1(1)	yes
116	fexth	7.1(5)N1(1)	7.3(13)N1(1)	yes
117	fex4	7.1(5)N1(1)	7.3(13)N1(1)	yes
118	fex4	7.1(5)N1(1)	7.3(13)N1(1)	yes
119	fexth	7.1(5)N1(1)	7.3(13)N1(1)	yes
120	fexth	7.1(5)N1(1)	7.3(13)N1(1)	yes
121	fexth	7.1(5)N1(1)	7.3(13)N1(1)	yes
122	fexth	7.1(5)N1(1)	7.3(13)N1(1)	yes
124	fexth	7.1(5)N1(1)	7.3(13)N1(1)	yes
1	microcontroller	v0.0.0.15	v0.0.0.15	no

- Check whether disable-fka is set on any of the FCoE NPV (VNP) ports as a pre-ISSU check.

```
switch# show fcoe-npv issu-impact
show fcoe-npv issu-impact
-----
```

Please make sure to enable "disable-fka" on all logged in VFCs
Please increase the FKA duration to 60 seconds on FCF

Active VNP ports with no disable-fka set

Upgrading Procedures

The ISSU process is triggered when you enter the **install all** command. This section describes the sequence of events that occur when you upgrade a single Cisco Nexus device or a single Cisco Nexus device that is connected to one or more FEXs.

The section includes the following topics:

- [Installation At-A-Glance, page 25](#)
- [Copying the Running Configuration from an External Flash Memory Device, page 26](#)
- [Copying the Startup Configuration from an External Flash Memory Device, page 27](#)
- [Upgrade Process in a Non-vPC Topology, page 28](#)
- [Upgrade Process for a vPC Topology on the Primary Switch, page 36](#)
- [Upgrade Process for a vPC Topology on the Secondary Switch, page 37](#)
- [Forcing an Upgrade, page 38](#)
- [Minimizing the Impact of a Disruptive Upgrade, page 39](#)
- [Upgrading a Direct vPC or a Single-Homed FEX Access Layer, page 39](#)
- [Upgrading a Dual-Homed FEX Access Layer, page 41](#)
- [Monitoring the Upgrade Status, page 51](#)

Installation At-A-Glance

The following table shows an overview of the upgrade process.

Table 7 Upgrade Process At-a-Glance

Upgrade Preparation	<ol style="list-style-type: none"> 1. Log in to the first Cisco Nexus device. We recommend that you log in to the console port. In vPC topologies, the first upgrade can be performed on either the primary or secondary switch in the topology. 2. Log in to Cisco.com to access the Software Download Center. To log in to Cisco.com, go to http://www.cisco.com/ and click Log In at the top of the page. Enter your Cisco username and password. 3. Choose and download the kickstart and system software files to the server. 4. Verify that the required space is available in the bootflash: directory for the image file(s) to be copied. 5. If you need more space in the bootflash: directory, delete unnecessary files to make space available. 6. Copy the Cisco NX-OS kickstart and system images to the bootflash using a transfer protocol such as ftp:, tftp:, scp:, or sftp. 7. Compare the file sizes of the images that were transferred using the dir bootflash command. The file sizes of the images obtained from Cisco.com and the image sizes of the transferred files should be the same. 8. Complete the above steps for each Cisco Nexus device in the topology.
Pre-ISSU Checks	<ol style="list-style-type: none"> 1. Enter the show incompatibility command to verify that the target image is feature-wise compatible with the current image. 2. Enter the show install all impact command to identify the upgrade impact. 3. Enter the show spanning-tree issu-impact command to display the impact of the upgrade. 4. Enter the show lacp issue-impact command to display the impact of the upgrade. 5. Enter the show fex command to verify that all the FEXs are online.
Upgrade Begins	<ol style="list-style-type: none"> 1. Enter the show vpc role command to verify the vPC switch role. 2. Enter the install all command to update to the latest Cisco NX-OS software. 3. Peruse the installer impact analysis and accept to proceed. <p>The Installer for the Cisco Nexus 5500 upgrades the software. The switch will now run a new version of the software.</p>
Upgrade Verification	<ol style="list-style-type: none"> 1. Enter the show install all status command to verify the status of the installation.

Copying the Running Configuration from an External Flash Memory Device

You can copy configuration files from an external flash memory device.

Before You Begin

Insert the external flash memory device into the active supervisor module.

	Command or Action	Purpose
Step 1	dir usb1:[directory/] Example: switch# dir usb1:	(Optional) Displays the files on the external flash memory device.
Step 2	copy {usb1:[directory/]filename {bootflash:}[directory/]filename Example: switch# copy usb1:n5500-uk9.7.3.8.N1.1.bin bootflash:n5500-uk9.7.3.8.N1.1.bin	Copies the image from an external flash memory device into the bootflash. The <i>filename</i> argument is case sensitive.
Step 3	copy {usb1:[directory/]filename running-config Example: switch# copy usb1:dsn-config.cfg running-config	Copies the running configuration from an external flash memory device. The <i>filename</i> argument is case sensitive.
Step 4	copy {usb1:[directory/]filename running-config Example: switch# copy usb1:dsn-config.cfg running-config	(Optional) Copies the running configuration from an external flash memory device to the bootflash.
Step 5	show running-config Example: switch# show running-config	(Optional) Displays the running configuration.
Step 6	copy running-config startup-config Example: switch# copy running-config startup-config	(Optional) Copies the running configuration to the startup configuration.
Step 7	show startup-config Example: switch# show startup-config	(Optional) Displays the startup configuration.

Copying the Startup Configuration from an External Flash Memory Device

You can recover the startup configuration on your Cisco NX-OS device by downloading a new startup configuration file saved on an external flash memory device.

Before You Begin

Insert the external flash memory device into the active supervisor module.

	Command or Action	Purpose
Step 1	dir {usb1: usb2:}[directory/] Example: switch# dir usb1:	(Optional) Displays the files on the external flash memory device.
Step 2	copy {usb1: usb2:}[directory/]filename {bootflash:}[directory/]filename Example: switch# copy usb1:n5500-uk9.7.3.8.N1.1.bin bootflash:n5500-uk9.7.3.8.N1.1.bin	Copies the image from an external flash memory device into the bootflash. The <i>filename</i> argument is case sensitive.

	Command or Action	Purpose
Step 3	copy {usb1: usb2:}[directory/]filename startup-config Example: switch# copy usb1:dsn-config.cfg startup-config	Copies a saved configuration from an external flash memory device to the startup configuration. The <i>filename</i> argument is case sensitive.
Step 4	copy {usb1: usb2:}[directory/]filename startup-config Example: switch# copy usb1:dsn-config.cfg bootflash-config	(Optional) Copies a saved configuration from an external flash memory device to the bootflash. The <i>filename</i> argument is case sensitive.
Step 5	show startup-config Example: switch# show startup-config	(Optional) Displays the startup configuration.
Step 6	copy running-config startup-config Example: switch# copy running-config startup-config	(Optional) Copies the running configuration to the startup configuration.
Step 7	show startup-config Example: switch# show startup-config	(Optional) Displays the startup configuration.

Upgrade Process in a Non-vPC Topology

The following list summarizes the upgrade process in a non-vPC topology:

1. The **install all** command triggers the installation upgrade.
2. The compatibility checks display the impact of the upgrade.
3. The installation proceeds or not based on the upgrade impact.
4. The current state is saved.
5. The system unloads and runs the new image.
6. The stateful restart of the system software and application occurs.
7. The installer resumes with the new image.
8. The FEXs are upgraded sequentially.
9. The installation completes.

The following example displays the ISSU process:

```
switch# install all kickstart n5500-uk9-kickstart.7.3.8.N1.1.bin system
n5500-uk9.7.3.8.N1.1.bin
```

```
Verifying image bootflash:/n5500-uk9-kickstart.7.3.8.N1.1.bin for boot variable
"kickstart".
```

```
[# [#####] 100% -- SUCCESS
```

```
Verifying image bootflash:/n5500-uk9.7.3.8.N1.1.bin for boot variable "system".
```

```
[#####] 100% -- SUCCESS
```

```
Verifying image type.
```

```
[#####] 100% -- SUCCESS
```

```
Extracting "system" version from image bootflash:/n5500-uk9.7.3.8.N1.1.bin.
```

```
[#####] 100% -- SUCCESS
```

```
Extracting "kickstart" version from image bootflash:/n5500-uk9-kickstart.7.3.8.N1.1.bin.
```

```
[#####] 100% -- SUCCESS
```

```
Extracting "bios" version from image bootflash:/n5500-uk9.7.3.8.N1.1.bin.
```

```

##### 100% -- SUCCESS
Extracting "fex3" version from image bootflash:/n5500-uk9.7.3.8.N1.1.bin.
##### 100% -- SUCCESS
Extracting "fexth" version from image bootflash:/n5500-uk9.7.3.8.N1.1.bin.
##### 100% -- SUCCESS
Extracting "fex4" version from image bootflash:/n5500-uk9.7.3.8.N1.1.bin.
##### 100% -- SUCCESS
Performing module support checks.
##### 100% -- SUCCESS
Notifying services about system upgrade.
##### 100% -- SUCCESS
Compatibility check is done:

```

Module	bootable	Impact	Install-type	Reason
1	yes	non-disruptive		reset
101	yes	non-disruptive		rolling
102	yes	non-disruptive		rolling
103	yes	non-disruptive		rolling
104	yes	non-disruptive		rolling
105	yes	non-disruptive		rolling
106	yes	non-disruptive		rolling
107	yes	non-disruptive		rolling
108	yes	non-disruptive		rolling
109	yes	non-disruptive		rolling
110	yes	non-disruptive		rolling
111	yes	non-disruptive		rolling
112	yes	non-disruptive		rolling
113	yes	non-disruptive		rolling
114	yes	non-disruptive		rolling
115	yes	non-disruptive		rolling
116	yes	non-disruptive		rolling
117	yes	non-disruptive		rolling
118	yes	non-disruptive		rolling
119	yes	non-disruptive		rolling
120	yes	non-disruptive		rolling
121	yes	non-disruptive		rolling
122	yes	non-disruptive		rolling
124	yes	non-disruptive		rolling

Images will be upgraded according to following table:

Module	Image	Running-Version	New-Version	Upg-Required
1	system	7.1(5)N1(1)	7.3(13)N1(1)	yes
1	kickstart	7.1(5)N1(1)	7.3(13)N1(1)	yes
1	bios	v2.1.7(06/16/2020)	v2.1.7(06/16/2020)	no
1	power-seq	v4.0	v4.0	no
1	fabric-power-seq	v4.0	v4.0	no
101	fex3	7.1(5)N1(1)	7.3(13)N1(1)	yes
102	fex3	7.1(5)N1(1)	7.3(13)N1(1)	yes
103	fexth	7.1(5)N1(1)	7.3(13)N1(1)	yes
104	fexth	7.1(5)N1(1)	7.3(13)N1(1)	yes
105	fexth	7.1(5)N1(1)	7.3(13)N1(1)	yes
106	fexth	7.1(5)N1(1)	7.3(13)N1(1)	yes
107	fexth	7.1(5)N1(1)	7.3(13)N1(1)	yes
108	fexth	7.1(5)N1(1)	7.3(13)N1(1)	yes
109	fexth	7.1(5)N1(1)	7.3(13)N1(1)	yes
110	fexth	7.1(5)N1(1)	7.3(13)N1(1)	yes
111	fexth	7.1(5)N1(1)	7.3(13)N1(1)	yes
112	fexth	7.1(5)N1(1)	7.3(13)N1(1)	yes
113	fex4	7.1(5)N1(1)	7.3(13)N1(1)	yes
114	fex4	7.1(5)N1(1)	7.3(13)N1(1)	yes

115	fex4	7.1(5)N1(1)	7.3(13)N1(1)	yes
116	fexth	7.1(5)N1(1)	7.3(13)N1(1)	yes
117	fex4	7.1(5)N1(1)	7.3(13)N1(1)	yes
118	fex4	7.1(5)N1(1)	7.3(13)N1(1)	yes
119	fexth	7.1(5)N1(1)	7.3(13)N1(1)	yes
120	fexth	7.1(5)N1(1)	7.3(13)N1(1)	yes
121	fexth	7.1(5)N1(1)	7.3(13)N1(1)	yes
122	fexth	7.1(5)N1(1)	7.3(13)N1(1)	yes
124	fexth	7.1(5)N1(1)	7.3(13)N1(1)	yes
1	microcontroller	v0.0.0.15	v0.0.0.15	no

Do you want to continue with the installation (y/n)? [n] y

Install is in progress, please wait.

Performing runtime checks.

[#####] 100% -- SUCCESS

Notifying services about the upgrade.

2020 Jun 10 11:52:06 5672-22 %\$ VDC-1 %\$ %NOHMS-2-NOHMS_ENV_SERR: Logging to /mnt/pss will be stopped as ISSU started

[#####] 100% -- SUCCESS

Setting boot variables.

[#####] 100% -- SUCCESS

Performing configuration copy.

[#####] 100% -- SUCCESS

Pre-loading modules.

[This step might take upto 20 minutes to complete - please wait.]

[*Warning -- Please do not abort installation/reload or powercycle fexes*]

```
[#          ] 0%2020 Jun 10 11:52:59 5672-22 %$ VDC-1 %$
%SATCTRL-FEX101-2-SATCTRL_IMAGE: FEX101 Image update in progress.
2020 Jun 10 11:53:11 5672-22 %$ VDC-1 %$ %SATCTRL-FEX102-2-SATCTRL_IMAGE: FEX102 Image
update in progress.
2020 Jun 10 11:53:23 5672-22 %$ VDC-1 %$ %SATCTRL-FEX103-2-SATCTRL_IMAGE: FEX103 Image
update in progress.
2020 Jun 10 11:53:33 5672-22 %$ VDC-1 %$ %SATCTRL-FEX104-2-SATCTRL_IMAGE: FEX104 Image
update in progress.
2020 Jun 10 11:53:43 5672-22 %$ VDC-1 %$ %SATCTRL-FEX105-2-SATCTRL_IMAGE: FEX105 Image
update in progress.
2020 Jun 10 11:53:53 5672-22 %$ VDC-1 %$ %SATCTRL-FEX106-2-SATCTRL_IMAGE: FEX106 Image
update in progress.
2020 Jun 10 11:54:03 5672-22 %$ VDC-1 %$ %SATCTRL-FEX107-2-SATCTRL_IMAGE: FEX107 Im###
] 5%2020 Jun 10 11:54:13 5672-22 %$ VDC-1 %$
%SATCTRL-FEX108-2-SATCTRL_IMAGE: FEX108 Image update in progress.
2020 Jun 10 11:54:23 5672-22 %$ VDC-1 %$ %SATCTRL-FEX109-2-SATCTRL_IMAGE: FEX109 Image
update in progress.
2020 Jun 10 11:54:33 5672-22 %$ VDC-1 %$ %SATCTRL-FEX110-2-SATCTRL_IMAGE: FEX110 Image
update in progress.
2020 Jun 10 11:54:43 5672-22 %$ VDC-1 %$ %SATCTRL-FEX111-2-SATCTRL_IMAGE: FEX111 Image
update in progress.
2020 Jun 10 11:54:53 5672-22 %$ VDC-1 %$ %SATCTRL-FEX112-2-SATCTRL_IMAGE: FEX112 Image
update in progress.
```

```

2020 Jun 10 11:54:59 5672-22 %$ VDC-1 %$ %SATCTRL-FEX113-2-SATCTRL_IMAGE: FEX113 Image
update in progress.
2020 Jun 10 11:55:08 5672-22 %$ VDC-1 %$ %SATCTRL-FEX114-2-SATCTRL_IMAGE: FEX114 Image
update in progress.
2020 Jun 10 11:55:21 5672-22 %$ VDC-1 %$ %SATCTRL-FEX115-2-SATCTRL_IMAGE: FEX115 Image
update in progress.
2020 Jun 10 11:55:33 5672-22 %$ VDC-1 %$ %SATCTRL-FEX116-2-SATCTRL_IMAGE: FEX116 Im[###
] 10%2020 Jun 10 11:55:37 5672-22 %$ VDC-1 %$
%SATCTRL-FEX117-2-SATCTRL_IMAGE: FEX117 Image update in progress.
2020 Jun 10 11:55:47 5672-22 %$ VDC-1 %$ %SATCTRL-FEX118-2-SATCTRL_IMAGE: FEX118 Image
update in progress.
2020 Jun 10 11:56:03 5672-22 %$ VDC-1 %$ %SATCTRL-FEX119-2-SATCTRL_IMAGE: FEX119 Image
update in progress. 2020 Jun 10 11:56:13 5672-22 %$ VDC-1 %$
%SATCTRL-FEX120-2-SATCTRL_IMAGE: FEX120 Image update in progress.
2020 Jun 10 11:56:23 5672-22 %$ VDC-1 %$ %SATCTRL-FEX121-2-SATCTRL_IMAGE: FEX121 Image
update in progress.
2020 Jun 10 11:56:33 5672-22 %$ VDC-1 %$ %SATCTRL-FEX122-2-SATCTRL_IMAGE: FEX122 Image
update in progress.
2020 Jun 10 11:56:43 5672-22 %$ VDC-1 %$ %SATCTRL-FEX124-2-SATCTRL_IMAGE: FEX124 Image
update in progress.
2020 Jun 10 11:57:13 5672-22 %$ VDC-1 %$ %SATCTRL-FEX114-2-SOHMS_ENV_ERROR: FEX-114
initiating shutting down in 60s due to fan failure
2020 Jun 10 11:57:15 5672-22 %$ VDC-1 %$ %SATCTRL-FEX114-2-SOHMS_ENV_ERROR: FEX-114 System
Fan access failure on Fan: 3
2020 Jun 10 11:57:15 5672-22 %$ VDC-1 %$ last message repeated 1 time
2020 Jun 10 11:57:15 5672-22 %$ VDC-1 %$ %SATCTRL-FEX114-2-SOHMS_ENV_ERROR: FEX-114 System
Fan access failure on Fan: 2
2020 Jun 10 11:57:15 5672-22 %$ VDC-1 %$ last message repeated 1 time
2020 Jun 10 11:57:15 5672-22 %$ VDC-1 %$ %SATCTRL-FEX114-2-SOHMS_ENV_ERROR: FEX-114 System
Fan [####
] 15%2020 Jun 10 11:57:15 5672-22 %$ VDC-1 %$ last message
repeated 3 times
2020 Jun 10 11:57:15 5672-22 %$ VDC-1 %$ %SATCTRL-FEX114-2-SOHMS_ENV_ERROR: FEX-114 System
Fan access failure on Fan: 2
2020 Jun 10 11:57:15 5672-22 %$ VDC-1 %$ %SATCTRL-FEX114-2-SOHMS_ENV_ERROR: FEX-114 System
Fan access failure on Fan: 1
2020 Jun 10 11:57:15 5672-22 %$ VDC-1 %$ %SATCTRL-FEX114-2-SOHMS_DIAG_ERROR: FEX-114
Recovered: System minor alarm on fans in fan tray 2
2020 Jun 10 11:57:15 5672-22 %$ VDC-1 %$ %SATCTRL-FEX114-2-SOHMS_DIAG_ERROR: FEX-114
System minor alarm on fans in fan tray 2
2020 Jun 10 11:57:16 5672-22 %$ VDC-1 %$ %SATCTRL-FEX114-2-SOHMS_ENV_ERROR: FEX-114
shutdown aborted
2020 Jun 10 11:57:16 5672-22 %$ VDC-1 %$ %SATCTRL-FEX114-2-SOHMS_DIAG_ERROR: FEX-114
Recovered: System minor alarm on fans in fan tray 3
2020 Jun 10 11:57:16 5672-22 %$ VDC-1 %$ %SATCTRL-FEX114-2-SOHMS_DIAG_ERROR: FEX-114
System minor alarm on fans in fan tray 3
2020 Jun 10 11:57:16 5672-22 %$ VDC-1 %$ %SATCTRL-FEX114-2-SOHMS_DIAG_ERROR: FEX-114
Recovered: System minor alarm on fans in fan tray 2
2020 Jun 10 11:57:55 5672-22 %$ VDC-1 %$ %SATCTRL-FEX114-2-SOHMS_ENV_ERROR: FEX-114 System
Fan access failure on Fan: 3
2020 Jun 10 11:57:55 5672-22 %$ VDC-1 %$ %SATCTRL-FEX114-2-SOHMS_ENV_ERROR: FEX-114 System
Fan access failure on Fan: 2
2020 Jun 10 11:57:55 5672-22 %$ VDC-1 %$ %SATCTRL-FEX114-2-SOHMS_ENV_ERROR: FEX-114 System
Fan access failure on Fan: 1
2020 Jun 10 11:58:35 5672-22 %$ VDC-1 %$ last message repeated 1 time
2020 Jun 10 11:58:35 5672-22 %$ VDC-1 %$ %SATCTRL-FEX103-2-SATCTRL_IMAGE: FEX103 Image
update complete. Install pending
2020 Jun 10 11:58:41 5672-22 %$ VDC-1 %$ %SATCTRL-FEX101-2-SATCTRL_IMAGE: FEX101 Image
update complete. Install pending
2020 Jun 10 11:58:44 5672-22 %$ VDC-1 %$ %SATCTRL-FEX104-2-SATCTRL_IMAGE: FEX104 Image
update co[#####
] 20%2020 Jun 10 11:59:00 5672-22 %$ VDC-1 %$
%SATCTRL-FEX102-2-SATCTRL_IMAGE: FEX102 Image update complete. Install pending
2020 Jun 10 11:59:08 5672-22 %$ VDC-1 %$ %SATCTRL-FEX106-2-SATCTRL_IMAGE: FEX106 Image
update complete. Install pending

```

```

2020 Jun 10 11:59:09 5672-22 %$ VDC-1 %$ %SATCTRL-FEX105-2-SATCTRL_IMAGE: FEX105 Image
update complete. Install pending
2020 Jun 10 11:59:27 5672-22 %$ VDC-1 %$ %SATCTRL-FEX107-2-SATCTRL_IMAGE: FEX107 Image
update complete. Install pending
2020 Jun 10 11:59:41 5672-22 %$ VDC-1 %$ %SATCTRL-FEX108-2-SATCTRL_IMAGE: FEX108 Image
update complete. Install pending
2020 Jun 10 11:59:45 5672-22 %$ VDC-1 %$ %SATCTRL-FEX114-2-SOHMS_ENV_ERROR: FEX-114 System
Fan access failure on Fan: 3
2020 Jun 10 11:59:45 5672-22 %$ VDC-1 %$ %SATCTRL-FEX114-2-SOHMS_DIAG_ERROR: FEX-114
System minor alarm on fans in fan tray 1
2020 Jun 10 12:00:01 5672-22 %$ VDC-1 %$ %SATCTRL-FEX110-2-SATCTRL_IMAGE: FEX110 Image
update complete. Install pending
2020 Jun 10 12:00:18 5672-22 %$ VDC-1 %$ %SATCTRL-FEX114-2-SOHMS_DIAG_ERROR: FEX-114
Recovered: System minor alar[#####
] 25%2020 Jun 10 12:01:02 5672-22 %$
VDC-1 %$ %SATCTRL-FEX111-2-SATCTRL_IMAGE: FEX111 Image update complete. Install pending
2020 Jun 10 12:01:03 5672-22 %$ VDC-1 %$ %SATCTRL-FEX114-2-SOHMS_ENV_ERROR: FEX-114 System
Fan access failure on Fan: 1
2020 Jun 10 12:01:03 5672-22 %$ VDC-1 %$ last message repeated 1 time

2020 Jun 10 12:01:03 5672-22 %$ VDC-1 %$ %SATCTRL-FEX114-2-SOHMS_ENV_ERROR: FEX-114 System
Fan access failure on Fan: 3
2020 Jun 10 12:01:03 5672-22 %$ VDC-1 %$ %SATCTRL-FEX114-2-SOHMS_ENV_ERROR: FEX-114 System
Fan access failure on Fan: 2
2020 Jun 10 12:01:03 5672-22 %$ VDC-1 %$ %SATCTRL-FEX114-2-SOHMS_ENV_ERROR: FEX-114 System
Fan access failure on Fan: 1
2020 Jun 10 12:01:03 5672-22 %$ VDC-1 %$ %SATCTRL-FEX114-2-SOHMS_DIAG_ERROR: FEX-114
System minor alarm on fans in fan tray 3
2020 Jun 10 12:01:03 5672-22 %$ VDC-1 %$ %SATCTRL-FEX114-2-SOHMS_DIAG_ERROR: FEX-114
Recovered: System minor alarm on fans in fan tray 1
2020 Jun 10 12:01:15 5672-22 %$ VDC-1 %$ %SATCTRL-FEX116-2-SATCTRL_IMAGE: FEX116 Image
update complete. Install pending
2020 Jun 10 12:01:34 5672-22 %$ VDC-1 %$ %SATCTRL-FEX109-2-SATCTRL_IMAGE: FEX109 Image
update co[#####
] 30%2020 Jun 10 12:02:02 5672-22 %$ VDC-1 %$
%SATCTRL-FEX119-2-SATCTRL_IMAGE: FEX119 Image update complete. Install pending
2020 Jun 10 12:02:09 5672-22 %$ VDC-1 %$ %SATCTRL-FEX120-2-SATCTRL_IMAGE: FEX120 Image
update complete. Install pending
2020 Jun 10 12:02:20 5672-22 %$ VDC-1 %$ %SATCTRL-FEX114-2-SOHMS_ENV_ERROR: FEX-114
initiating shutting down in 60s due to fan failure
2020 Jun 10 12:02:22 5672-22 %$ VDC-1 %$ %SATCTRL-FEX114-2-SOHMS_ENV_ERROR: FEX-114
shutdown aborted
2020 Jun 10 12:02:22 5672-22 %$ VDC-1 %$ %SATCTRL-FEX114-2-SOHMS_ENV_ERROR: FEX-114 System
Fan access failure on Fan: 2
2020 Jun 10 12:02:22 5672-22 %$ VDC-1 %$ last message repeated 1 time
2020 Jun 10 12:02:22 5672-22 %$ VDC-1 %$ %SATCTRL-FEX114-2-SOHMS_ENV_ERROR: FEX-114 System
Fan access failure on Fan: 1
2020 Jun 10 12:02:22 5672-22 %$ VDC-1 %$ last message repeated 1 time
2020 Jun 10 12:02:22 5672-22 %$ VDC-1 %$ %SATCTRL-FEX114-2-SOHMS_ENV_ERROR: FEX-114 System
Fan access failure on Fan: 2
2020 Jun 10 12:02:22 5672-22 %$ VDC-1 %$ %SATCTRL-FEX114-2-SOHMS_DIAG_ERROR: FEX-114
System minor alarm on fans in fan tray 2
2020 Jun 10 12:02:22 5672-22 %$ VDC-1 %$ %SATCTRL-FEX114-2-SOHMS_DIAG_ERROR: FEX-114
Recovered: System minor alarm on fans in fan tray 2
2020 Jun 10 12:02:35 5672-22 %$ VDC-1 %$ %SATCTRL-FEX124-2-SATCTRL_IMAGE: FEX124 Image
update complete. Install pending
2020 Jun 10 12:02:36 5672-22 %$ VDC-1 %$ %SATCTRL-FEX112-2-SATCTRL_IMAGE: FEX112 Image
update complete. Install pending
2020 Jun 10 12:02:42 5672-22 %$ VDC-1 %$ %SATCTRL-FEX122-2-SATCTRL_IMAGE: FEX122 Image
update complete. Install pending
2020 Jun 10 12:02:42 5672-22 %$ VDC-1 %$ %SATCTRL-FEX121-2-SATCTRL_IMAGE: FEX121 Image
update co[#####
] 35%2020 Jun 10 12:04:18 5672-22 %$ VDC-1 %$
%SATCTRL-FEX117-2-SATCTRL_IMAGE: FEX117 Image update complete. Install pending
2020 Jun 10 12:04:22 5672-22 %$ VDC-1 %$ %SATCTRL-FEX113-2-SATCTRL_IMAGE: FEX113 Image
update complete. Install pending

```



```

2020 Jun 10 12:04:33 5672-22 %$ VDC-1 %$ %SATCTRL-FEX114-2-SATCTRL_IMAGE: FEX114 Image
update complete. Install pending
2020 Jun 10 12:04:42 5672-22 %$ VDC-1 %$ %SATCTRL-FEX115-2-SATCTRL_IMAGE: FEX115 Image
update complete. Install pending
2020 Jun 10 12:04:38 5672-22 %$ VDC-1 %$ %SATCTRL-FEX118-2-SATCTRL_IMAGE: FEX118 Image
update co[#####] 100% -- SUCCESS
Upgrade can no longer be aborted, any failure will result in a disruptive upgrade.
Requesting Line Cards to stop communication.

```

```

[#####] 100% -- SUCCESS
Requesting Sup Apps to stop communication.
[#####] 100% -- SUCCESS
Freeing memory in the file system.

```

```
[#####] 100% -- SUCCESS
```

```
Loading images into memory.
```

```
[#####] 100% -- SUCCESS
```

```
Saving supervisor runtime state.
```

```
[#####] 100% -- SUCCESS
```

```
Saving mts state.
```

```
[#####[ 5534.342098] writing reset reason 88, <NULL>
```

```
#####] 100% -- SUCCESS
```

```
Reloading the kernel to proceed with the upgrade.
```

```
All telnet and ssh connections will now be temporarily terminated.
```

```

[ 5537.995815] Starting new kernel
[ 5538.005327] Calling kexec callback
[ 5538.010001] Moving to new kernel
[ 5538.010001] Calling into reboot_code_buffer code
INIT: [ 11.817499] val:166, count7 .
[ 11.826357] TCO_TMR val:166, SMI_EN= 0x42003 NMI_STS_CNT_REG = 0x21 count7 .
Executing /etc/rc.d/rcS.d/S07firmware-upgrade-eusb
eUSB firmware upgrade not required
autoneg unmodified, ignoring
autoneg unmodified, ignoring
Checking all filesystems..... done.
Loading system software

```

```

Fri Jun 10 12:06:06 UTC 2020 BIGSUR SYNC getting started issu = 1
Fri Jun 10 12:06:06 UTC 2020 ISSU BIGSUR SYNC getting started inside if loop
Fri Jun 10 12:06:07 UTC 2020 SUP BIGSUR BASE ADDRESS = 0xb6000000
SUP HI got SYNCHONISED-----
Fri Jun 10 12:06:07 UTC 2020 ISSU BIGSUR SYNC END
Uncompressing system image: bootflash:/n5500-uk9.7.3.8.N1.1.bin Fri Jun 10 12:06:07 UTC
2020
Load plugins that defined in image conf: /isan/plugin_img/img.conf
load_plugin: Plugin-swid map exists. Any plugin exists in the map will be assigned from
the map
Loading plugin 0: core_plugin...
load_plugin: Can't get exclude list from /isan/plugin/0/boot/etc/plugin_exclude.conf (rc
0x40ea0017)
Loading plugin 1: eth_plugin...
ethernet switching mode
INIT: Entering runlevel: 3
touch: cannot touch `/var/lock/subsys/netfs': No such file or directory
Mounting other filesystems: [ OK ]
/isan/bin/muxif_config: fex vlan id: -f,4042

```

```

Set name-type for VLAN subsystem. Should be visible in /proc/net/vlan/config
Added VLAN with VID == 4042 to IF -:muxif:-
card index: 0x2b58
2020 Jun 10 12:06:57 5672-22 %$ VDC-1 %$ %SYSLOG-2-SYSTEM_MSG : Syslogs wont be logged
into logflash until logflash is online
2020 Jun 10 12:06:59 5672-22 %$ VDC-1 %$ %USER-2-SYSTEM_MSG: CLIS: loading cmd files
begin - clis
2020 Jun 10 12:06:59 5672-22 %$ VDC-1 %$ %DAEMON-2-SYSTEM_MSG: <<%XMLMA-2-XMLMACRIT>> XML
master agent: Starting sysmgr handshake. - xmlma[4280]
2020 Jun 10 12:06:59 5672-22 %$ VDC-1 %$ %DAEMON-2-SYSTEM_MSG: <<%XMLMA-2-XMLMACRIT>> XML
master agent: Done with sysmgr handshake. - xmlma[4280]
2020 Jun 10 12:06:10 5672-22 %$ VDC-1 %$ %SATCTRL-FEX114-2-SOHMS_ENV_ERROR: FEX-114
initiating shutting down in 60s due to fan failure
2020 Jun 10 12:06:11 5672-22 %$ VDC-1 %$ %SATCTRL-FEX114-2-SOHMS_ENV_ERROR: FEX-114
shutdown aborted
2020 Jun 10 12:06:11 5672-22 %$ VDC-1 %$ %SATCTRL-FEX114-2-SOHMS_ENV_ERROR: FEX-114 System
Fan access failure on Fan: 2
2020 Jun 10 12:06:11 5672-22 %$ VDC-1 %$ %SATCTRL-FEX114-2-SOHMS_ENV_ERROR: FEX-114 System
Fan access failure on Fan: 1
2020 Jun 10 12:06:11 5672-22 %$ VDC-1 %$ %SATCTRL-FEX114-2-SOHMS_ENV_ERROR: FEX-114 System
Fan access failure on Fan: 3
2020 Jun 10 12:06:11 5672-22 %$ VDC-1 %$ %SATCTRL-FEX114-2-SOHMS_ENV_ERROR: FEX-114 System
Fan access failure on Fan: 1
2020 Jun 10 12:06:11 5672-22 %$ VDC-1 %$ %SATCTRL-FEX114-2-SOHMS_DIAG_ERROR: FEX-114
System minor alarm on fans in fan tray 1
2020 Jun 10 12:06:11 5672-22 %$ VDC-1 %$ %SATCTRL-FEX114-2-SOHMS_DIAG_ERROR: FEX-114
Recovered: System minor alarm on fans in fan tray 1
2020 Jun 10 12:07:12 5672-22 %$ VDC-1 %$ %CALLHOME-2-EVENT: FEX_FAN_FAILURE
2020 Jun 10 12:07:16 5672-22 %$ VDC-1 %$ %CALLHOME-2-EVENT: FEX_FAN_FAILURE
2020 Jun 10 12:07:16 5672-22 %$ VDC-1 %$ %USER-2-SYSTEM_MSG: CLIS: loading cmd files end
- clis
2020 Jun 10 12:07:16 5672-22 %$ VDC-1 %$ %USER-2-SYSTEM_MSG: CLIS: init begin - clis
2020 Jun 10 12:07:28 5672-22 %$ VDC-1 %$ %KERN-0-SYSTEM_MSG: [ 11.817499] val:166,
count7 . - kernel
2020 Jun 10 12:07:28 5672-22 %$ VDC-1 %$ %KERN-0-SYSTEM_MSG: [ 11.826357] TCO_TMR
val:166, SMI_EN= 0x42003 NMI_STS_CNT_REG = 0x21 count7 . - kernel
2020 Jun 10 12:07:41 5672-22 %$ VDC-1 %$ %PFMA-2-KEXEC: Loading new kernel started at Jun
10 12:05:44.
2020 Jun 10 12:07:41 5672-22 %$ VDC-1 %$ %PFMA-2-PFM_INIT: PFM Initiated at Jun 10
12:06:57.
2020 Jun 10 12:07:41 5672-22 %$ VDC-1 %$ %PFMA-2-BOX_ONLINE: BOX ONLINE : Jun 10 12:07:41.
2020 Jun 10 12:07:41 5672-22 %$ VDC-1 %$ %PFMA-2-FEX_STATUS: Fex 101 is online
2020 Jun 10 12:07:41 5672-22 %$ VDC-1 %$ %PFMA-2-FEX_STATUS: Fex 104 is online
2020 Jun 10 12:07:41 5672-22 %$ VDC-1 %$ %PFMA-2-FEX_STATUS: Fex 102 is online
2020 Jun 10 12:07:41 5672-22 %$ VDC-1 %$ %PFMA-2-FEX_STATUS: Fex 106 is online
2020 Jun 10 12:07:41 5672-22 %$ VDC-1 %$ %PFMA-2-FEX_STATUS: Fex 107 is online
2020 Jun 10 12:07:41 5672-22 %$ VDC-1 %$ %PFMA-2-FEX_STATUS: Fex 103 is online
2020 Jun 10 12:07:41 5672-22 %$ VDC-1 %$ %PFMA-2-FEX_STATUS: Fex 108 is online
2020 Jun 10 12:07:41 5672-22 %$ VDC-1 %$ %PFMA-2-FEX_STATUS: Fex 113 is online
2020 Jun 10 12:07:41 5672-22 %$ VDC-1 %$ %PFMA-2-FEX_STATUS: Fex 110 is online
2020 Jun 10 12:07:41 5672-22 %$ VDC-1 %$ %PFMA-2-FEX_STATUS: Fex 111 is online
2020 Jun 10 12:07:41 5672-22 %$ VDC-1 %$ %PFMA-2-FEX_STATUS: Fex 114 is online
2020 Jun 10 12:07:41 5672-22 %$ VDC-1 %$ %PFMA-2-FEX_STATUS: Fex 115 is online
2020 Jun 10 12:07:41 5672-22 %$ VDC-1 %$ %PFMA-2-FEX_STATUS: Fex 112 is online
2020 Jun 10 12:07:41 5672-22 %$ VDC-1 %$ %PFMA-2-FEX_STATUS: Fex 117 is online
2020 Jun 10 12:07:41 5672-22 %$ VDC-1 %$ %PFMA-2-FEX_STATUS: Fex 116 is online
2020 Jun 10 12:07:41 5672-22 %$ VDC-1 %$ %PFMA-2-FEX_STATUS: Fex 118 is online
2020 Jun 10 12:07:41 5672-22 %$ VDC-1 %$ %PFMA-2-FEX_STATUS: Fex 119 is online
2020 Jun 10 12:07:41 5672-22 %$ VDC-1 %$ %PFMA-2-FEX_STATUS: Fex 121 is online
2020 Jun 10 12:07:41 5672-22 %$ VDC-1 %$ %PFMA-2-FEX_STATUS: Fex 122 is online
2020 Jun 10 12:07:41 5672-22 %$ VDC-1 %$ %PFMA-2-FEX_STATUS: Fex 124 is online
2020 Jun 10 12:07:41 5672-22 %$ VDC-1 %$ %PFMA-2-FEX_STATUS: Fex 120 is online
2020 Jun 10 12:07:41 5672-22 %$ VDC-1 %$ %PFMA-2-FEX_STATUS: Fex 105 is online
2020 Jun 10 12:07:41 5672-22 %$ VDC-1 %$ %PFMA-2-FEX_STATUS: Fex 109 is online

```

```

Continuing with installation process, please wait.
The login will be disabled until the installation is completed.
Performing supervisor state verification.
2020 Jun 10 12:07:45 5672-22 %$ VDC-1 %$ %USER-2-SYSTEM_MSG:
<<%INSTALLER-2-LACP_DOWN_TIME>> LACP control plane was down for 84.000000 seconds during
ISSU. - new_installer
[#####] 100% -- SUCCESS
Supervisor non-disruptive upgrade successful.
Module 101: Non-disruptive upgrading.
[#          ] 0%2020 Jun 10 12:09:11 5672-22 %$ VDC-1 %$
%NOHMS-2-NOHMS_ENV_FEX_ONLINE: FEX-101 On-line
2020 Jun 10 12:09:11 5672-22 %$ VDC-1 %$ %CALLHOME-2-EVENT: FEX_ONLINE
2020 Jun 10 12:09:13 5672-22 %$ VDC-1 %$ %CALLHOME-2-EVENT: FEX_ONLINE
2020 Jun 10 12:09:13 5672-22 %$ VDC-1 %$ %PFMA-2-FEX_S[#####] 100% --
SUCCESS
Module 102: Non-disruptive upgrading.

[#          ] 0%2020 Jun 10 12:10:48 5672-22 %$ VDC-1 %$
%NOHMS-2-NOHMS_ENV_FEX_ONLINE: FEX-102 On-line
2020 Jun 10 12:10:48 5672-22 %$ VDC-1 %$ %CALLHOME-2-EVENT: FEX_ONLINE
2020 Jun 10 12:10:51 5672-22 %$ VDC-1 %$ %CALLHOME-2-EVENT: FEX_ONLINE
2020 Jun 10 12:10:51 5672-22 %$ VDC-1 %$ %PFMA-2-FEX_S[#####] 100% --
SUCCESS
Module 103: Non-disruptive upgrading.
[#          ] 0%2020 Jun 10 12:12:11 5672-22 %$ VDC-1 %$
%NOHMS-2-NOHMS_ENV_FEX_ONLINE: FEX-103 On-line
2020 Jun 10 12:12:11 5672-22 %$ VDC-1 %$ %CALLHOME-2-EVENT: FEX_ONLINE
2020 Jun 10 12:12:12 5672-22 %$ VDC-1 %$ %CALLHOME-2-EVENT: FEX_ONLINE
2020 Jun 10 12:12:12 5672-22 %$ VDC-1 %$ %PFMA-2-FEX_S[#####] 100% --
SUCCESS
Module 104: Non-disruptive upgrading.
[#          ] 0%2020 Jun 10 12:13:33 5672-22 %$ VDC-1 %$
%NOHMS-2-NOHMS_ENV_FEX_ONLINE: FEX-104 On-line
2020 Jun 10 12:13:33 5672-22 %$ VDC-1 %$ %CALLHOME-2-EVENT: FEX_ONLINE
2020 Jun 10 12:13:35 5672-22 %$ VDC-1 %$ %CALLHOME-2-EVENT: FEX_ONLINE
2020 Jun 10 12:13:35 5672-22 %$ VDC-1 %$ %PFMA-2-FEX_S[#####] 100% --
SUCCESS

```

```
switch-2# show version
```

```

Cisco Nexus Operating System (NX-OS) Software
TAC support: http://www.cisco.com/tac
Documents: http://www.cisco.com/en/US/products/ps9372/tsd_products_support_series_home.html
Copyright (c) 2002-2020, Cisco Systems, Inc. All rights reserved.
The copyrights to certain works contained herein are owned by
other third parties and are used and distributed under license.
Some parts of this software are covered under the GNU Public
License. A copy of the license is available at
http://www.gnu.org/licenses/gpl.html.

```

```

Software
  BIOS:          version 2.1.7
  Power Sequencer Firmware:
    Module 1: v4.0
  Fabric Power Sequencer Firmware: Module 1: version v4.0
  Microcontroller Firmware:      version v0.0.0.15
  QSFP Microcontroller Firmware:
    Module not detected
  SFP Microcontroller Firmware:
    Module 1: v1.3.0.0
  CXP Microcontroller Firmware:
    Module not detected

```

```
kickstart: version 7.3(13)N1(1) [build 7.3(13)N1(1)]
system:     version 7.3(13)N1(1) [build 7.3(13)N1(1)]
BIOS compile time:      06/16/2020
kickstart image file is: bootflash:///n5500-uk9-kickstart.7.3.8.N1.1.bin
kickstart compile time: 7/14/2020 3:00:00 [07/14/2020 15:53:36]
system image file is:   bootflash:///n5500-uk9.7.3.8.N1.1.bin
system compile time:    7/14/2020 3:00:00 [07/14/2020 15:55:35]
```

Hardware

```
cisco Nexus 5672UP Chassis ("Nexus 5672UP Supervisor")
Intel(R) Xeon(R) CPU @ 1.80 with 8244148 kB of memory.
Processor Board ID FOC18345ZGR
```

```
Device name: 5672-22
bootflash:   7864320 kB
```

Kernel uptime is 0 day(s), 4 hour(s), 12 minute(s), 55 second(s)

Last reset at 342091 usecs after Fri Jun 10 12:05:43 2020

```
Reason: Reset due to upgrade
System version: 7.1(5)N1(1)
```

Upgrade Process for a vPC Topology on the Primary Switch

The following list summarizes the upgrade process on a primary switch in a vPC topology. Steps that differ from a switch upgrade in a non-vPC topology are in bold.



Note

In vPC topologies, the two peer switches must be upgraded individually. An upgrade on one peer switch does not automatically update the vPC peer switch.

1. The **install all** command issued on the vPC primary switch triggers the installation upgrade.
2. The compatibility checks display the impact of the upgrade.
3. The installation proceeds or not based on the upgrade impact.
4. The configuration is locked on both vPC peer switches.
5. The current state is saved.
6. The system unloads and runs the new image.
7. The stateful restart of the system software and application occurs.
8. The installer resumes with the new image.
9. The FEXs are upgraded sequentially.
10. The installation is complete.

When the installation is complete, the vPC primary switch and the FEXs that are connected to the primary switch are upgraded. The single-homed FEXs and the dual-homed FEXs are now running the upgraded software.



Note

The dual-homed FEXs are now connected to the primary and secondary switches that are running two different versions of the Cisco NX-OS software. The vPC primary switch is running the upgraded version and the vPC secondary switch is running the original software version. The Cisco NX-OS

software has been designed to allow an upgraded dual-home FEX to interoperate with vPC secondary switches running the original version of Cisco NX-OS while the primary switch is running the upgrade version.

Upgrade Process for a vPC Topology on the Secondary Switch

The following list summarizes the upgrade process on a secondary switch in a vPC topology. Steps that differ from a switch upgrade in a non-vPC topology are in bold.

1. The **install all** command issued on the vPC second switch triggers the installation upgrade.
2. The compatibility checks display the impact of the upgrade.
3. The installation proceeds or not based on the upgrade impact.
4. The current state is saved.
5. The system unloads and runs the new image.
6. The stateful restart of the system software and application occurs.
7. The installer resumes with the new image.
8. The FEXs are upgraded sequentially. The upgrade completes on the single-homed FEXs and a sanity check is performed on the dual-homed FEXs.



Note The dual-homed FEXs were upgraded by the primary switch.

9. The configuration is unlocked on the primary and secondary switches.
10. The installation is complete.

Disruptive Installation Process



Note Doing a disruptive upgrade between incompatible images will result in loss of certain configurations such as unified ports, breakout, and FEX configurations. See [CSCu122703](#) for details.



Note Doing a disruptive upgrade or downgrade between incompatible images is not supported with the autoconfig feature. See [CSCvb41199](#) for details.

For FEX configurations, prior to the downgrade, the configuration must be converted (if not already used) to use FEX pre-provisioning configuration.

The following lists the situations where a nondisruptive ISSU might not be possible when upgrading a Cisco Nexus device:

- The topology and/or features are not ISSU ready. See the “[ISSU Prerequisites](#)” section on page 17 for more information.
- The current release or target release is lower than Release 7.0.(0)N1(1). An ISSU can work only when both the current and target releases are equal or later than Release 7.0.(0)N1(1).

- The installation is a downgrade, such as a higher release to a lower release, unless stated otherwise in the [“Upgrade Guidelines” section on page 3](#).
- You want to do a disruptive upgrade. See the [“Forcing an Upgrade” section on page 38](#).

Restoring the Configuration

Perform the following steps to restore the configuration if the configurations contain interface breakout or unified port configurations:

1. Save the configuration to bootflash using the command **copy running-config bootflash:[directory/]filename**.
2. Use the **default interface** command to restore the default configurations of the breakout interfaces. Example: **default interface e1/49/1-4, e2/25/1-4**.
3. Save the running configuration to startup configuration using the **copy running-config startup-config** command.
4. Perform software migration using the **install all** command from Cisco NX-OS Release 7.3(13)N1(1) to a lower version. In case of VPC, downgrade the primary switch first and then the secondary switch.
5. After the switch is up, power-off and power-on the module for the interface breakout to be effective. If the breakout is configured on Baseboard module, save the running configuration to startup configuration using the **copy running-config startup-config** command and then reload the switch again.
6. If breakout is not configured on the Baseboard, then an additional reload is required if running configuration contains **hardware profile route resource service-template**.
7. After the switch is up (with all the modules), copy the saved configuration from **bootflash:<filename>** to **running-config**.
8. Verify if all the interfaces are up and traffic is resumed.

Forcing an Upgrade

You can choose to do a disruptive upgrade if one of the ISSU conditions are not met. One additional reason where you might choose to do a disruptive upgrade is when FEXs are upgraded in a rolling fashion (one FEX at a time), which requires a longer maintenance window. With a disruptive upgrade, all the connected FEXs are upgraded simultaneously, so the maintenance window can be shorter. If you need a shorter maintenance window (with traffic disruption), you can force a disruptive upgrade even if an ISSU can be leveraged. It is important to note the possibility of an outage if you do a disruptive upgrade.

```
switch # install all force kickstart bootflash:/kickstart_image.bin system
bootflash:/system_image.bin

Installer is forced disruptive

Verifying image bootflash:/kickstart_image.bin for boot variable "kickstart".
[#####] 100% -- SUCCESS

Verifying image bootflash:/system_image.bin for boot variable "system".
...
```

You can also add the **force** keyword at the end of the **install all** command as follows:

```
switch # install all kickstart bootflash:/kickstart_image.bin system
bootflash:/system_image.bin force
```

```
Installer is forced disruptive
```

```
Verifying image bootflash:/kickstart_image.bin for boot variable "kickstart".
...
```

Minimizing the Impact of a Disruptive Upgrade

A non-ISSU upgrade is a disruptive upgrade that results in the reload of the Cisco Nexus device and the Fabric Extenders. The reload is a cold reboot that brings down the control plane and the data plane. The reload causes disruptions to the connected servers and hosts. When a vPC is deployed in the access layer, it is possible to minimize the impact of a non-ISSU upgrade. When one of the vPC switches is being reset during the upgrade process, all the server traffic can flow through its vPC peer.

Upgrading a Direct vPC or a Single-Homed FEX Access Layer

The following figures show topologies in which the access layer includes a vPC configuration to hosts or downstream switches.

Figure 16 *Hosts Directly Connected to vPC Peers*

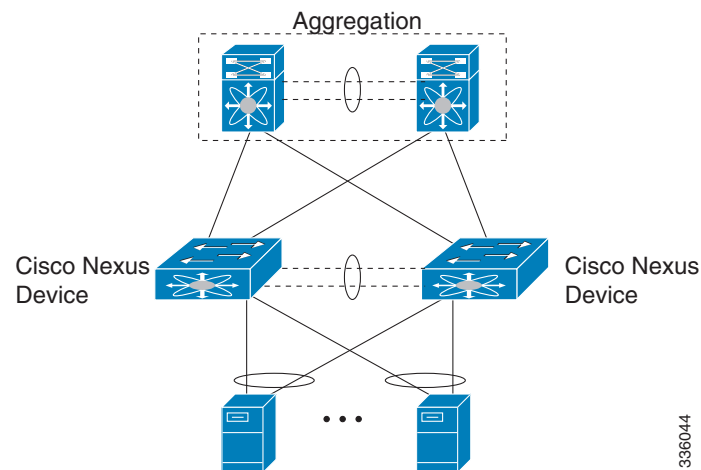
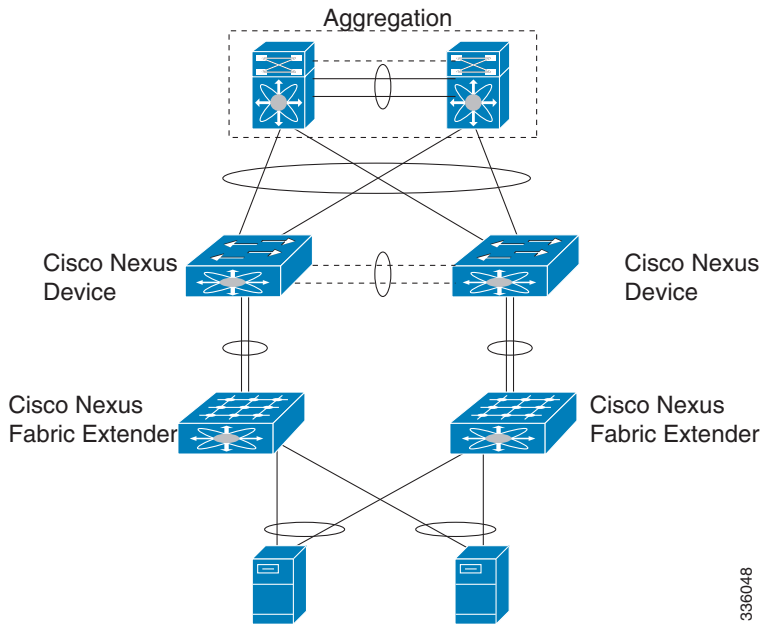
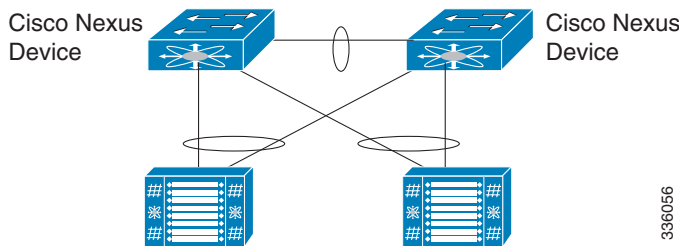

Figure 17 *vPC Peered Dual-Supervisor Virtual Modular System Dual-Homed FEXs and Singled-Homed FEXs*



336048

Figure 18 *Cisco Nexus Device Connected to Downstream Switches*



336056

To upgrade the access layer without a disruption to hosts, follow these tasks:

- Upgrade the first vPC switch (vPC primary switch). During this upgrade, the switch is reloaded. When the switch is reloaded, the servers or the downstream switch detects a loss of connectivity to the first switch and starts forwarding traffic to the second (vPC secondary) switch.
- Verify that the upgrade of the switch has completed successfully. At the completion of the upgrade, the switch restores vPC peering, connected Nexus 2000 Fabric Extenders, and all the links.
- Upgrade the second switch. Repeating the same process on the second switch causes the second switch to reload during the upgrade process. During this reload, the first (upgraded) switch forwards all the traffic to/from servers.
- Verify that the upgrade of the second switch has completed successfully.

Note

Flows that are forwarded to a switch during an upgrade on the switch, will failover to the second switch. Also, flows are redistributed when vPC peers are active. The traffic disruption is limited to the time required for the server or host to detect the link-down and link-up events and to redistribute the flows.

Upgrading a Dual-Homed FEX Access Layer

A disruptive upgrade causes a switch and connected FEXs to reload. The time required for a FEX to reload is less than the time required for a switch to reload. When hosts are connected to a dual-homed FEX, it is possible to keep the traffic disruption of the hosts to same time as required by FEX to reload (approximately 120 seconds), instead of the time required for an upgrade of the entire access layer.

The following figure shows a dual-homed FEX topology in which the access layer includes a vPC configuration to hosts or downstream switches.

Figure 19 vPC-Peered Dual-Supervisor Virtual Modular System Dual-Homed FEXs

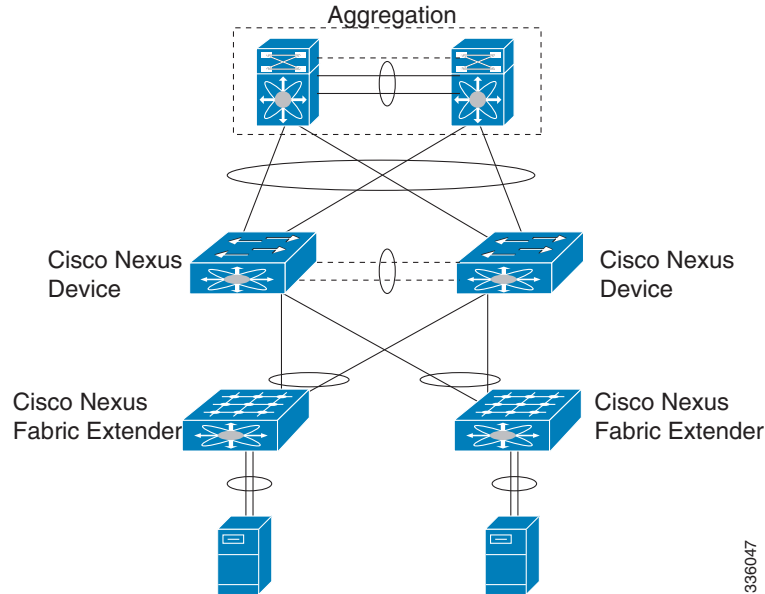

Note

The following dual-homed FEX procedure is supported only for an upgrade and not for a downgrade.

- Step 1** Configure FEX module pre-provisioning for all the FEXs connected to both the switches (vPC primary and vPC secondary switches).
- Upgrade the vPC primary switch with the new image using the **install all kickstart image system image** command. During the upgrade process, the switch is reloaded. When the switch is reloaded, only single-homed FEXs connected to the switch are reloaded and dual-homed FEXs are not reloaded. Servers connected to the dual-homed FEXs retain network connectivity through the vPC secondary switch.
- Step 2** Verify that the upgrade of the vPC primary switch is completed successfully. At the completion of the upgrade, the vPC primary switch restores vPC peering. However, dual-homed FEXs are connected only to the secondary vPC switch.
- Step 3** Reload the dual-homed FEXs using the **reload fex** command from the vPC secondary switch. Reload the FEXs one-by-one or in a bunch of two or three FEXs. The servers connected to the dual-homed FEXs will lose connectivity.
- Step 4** Wait for the FEXs to reload. After the reload, the FEXs connect to the upgraded switch (vPC primary switch).

- Step 5** Upgrade the vPC secondary switch with the new image using the **install all kickstart image system image** command. During the upgrade process, the switch is reloaded. When the switch is reloaded, only singled-homed FEXs connected to the switch are reloaded and dual-homed FEXs are not reloaded.
- Step 6** Verify that the upgrade of the vPC secondary switch is completed successfully. At the completion of the upgrade, the vPC secondary switch restores vPC peering. Dual-homed FEXs connect to both the peer switches and start forwarding traffic.

Detailed Steps

- Step 1** Log in to Cisco.com to access the Software Download Center. To log in to Cisco.com, go to <http://www.cisco.com/> and click **Log In** at the top of the page. Enter your Cisco username and password.



Note Unregistered Cisco.com users cannot access the links provided in this document.

Access the Software Download Center at <http://www.cisco.com/cisco/software/navigator.html?a=a&i=rpm>. Navigate to the software downloads for Cisco Nexus devices. Links to the download images for the switch are listed.

- Step 2** Choose and download the kickstart and system software files to a local server.
- Step 3** Verify that the required space is available in the bootflash: directory for the image file(s) to be copied.

```
switch# dir bootflash: | sec Usage

Usage for bootflash://sup-local
 1748185088 bytes used
 5806157824 bytes free
 7554342912 bytes total
```

We recommend that you keep the kickstart and system image files for at least one previous software release to use if the new image files do not load successfully.

- Step 4** (Optional) If you need more space on the bootflash, delete unnecessary files to make space available.
- Step 5** Copy the new kickstart and system images to each switch bootflash by using a transfer protocol such as FTP, TFTP, SCP, or SFTP.

```
switch-1# dir bootflash: inc 7.3
35756544 Feb 18 13:24:46 2020 n5500-uk9-kickstart.7.1.4.N1.1.bin
35792384 Jun 21 10:49:30 2020 n5500-uk9-kickstart.7.3.8.N1.1.bin
325724988 Feb 18 13:23:22 2020 n5500-uk9.7.1.4.N1.1.bin
324046051 Oct 21 10:49:10 2020 n5500-uk9.7.3.8.N1.1.bin
```

- Step 6** Configure FEX Module pre-provisioning for the type of FEX present in the system. Perform this step on both the switches in a vPC pair. For more information on how to configure FEX module pre-provisioning, refer the *Cisco Nexus 5500 Series NX-OS System Management Configuration Guide*.

This example shows how to select slot 130 and the N2K-C2348UPQ module to pre-provision.

```
switch# show fex
FEX      FEX      FEX      FEX      Fex
Number   Description  State      Model      Serial
-----
130      FEX0130      Online     N2K-C2348UPQ  FOC1818R2MF
198      FEX0198      Online     N2K-C2332TQ-10GT  FOC1910R0R1

switch# configure terminal
switch(config)# slot 130
```

```
switch(config-slot)# provision model N2K-C2348UPQ
switch(config-slot)# slot 198
switch(config-slot)# provision model N2K-C2332TQ
```

Step 7 Enter the **show install all impact** command to validate the upgrade process and the components being upgraded.

```
switch-1# show install all impact kickstart bootflash:n5500-uk9-kickstart.7.3.8.N1.1.bin
system bootflash:n5500-uk9.7.3.8.N1.1.bin
```

```
Verifying image bootflash:/n5500-uk9-kickstart.7.3.8.N1.1.bin for boot variable
"kickstart".
```

```
[#####] 100% -- SUCCESS
```

```
Verifying image bootflash:/n5500-uk9.7.3.8.N1.1.bin for boot variable "system".
```

```
[#####] 100% -- SUCCESS
```

```
Verifying image type.
```

```
[#####] 100% -- SUCCESS
```

```
Extracting "system" version from image bootflash:/n5500-uk9.7.3.8.N1.1.bin.
```

```
[#####] 100% -- SUCCESS
```

```
Extracting "kickstart" version from image bootflash:/n5500-uk9-kickstart.7.3.8.N1.1.bin.
```

```
[#####] 100% -- SUCCESS
```

```
Extracting "bios" version from image bootflash:/n5500-uk9.7.3.8.N1.1.bin.
```

```
[#####] 100% -- SUCCESS
```

```
Extracting "fex3" version from image bootflash:/n5500-uk9.7.3.8.N1.1.bin.
```

```
[#####] 100% -- SUCCESS
```

```
Extracting "fex4" version from image bootflash:/n5500-uk9.7.3.8.N1.1.bin.
```

```
[#####] 100% -- SUCCESS
```

```
Performing module support checks.
```

```
[#####] 100% -- SUCCESS
```

```
Notifying services about system upgrade.
```

```
[#####] 100% -- SUCCESS
```

Compatibility check is done:

Module	bootable	Impact	Install-type	Reason
1	yes	disruptive	reset	Non-disruptive install not supported if L3 was enabled
2	yes	disruptive	reset	Non-disruptive install not supported if L3 was enabled
3	yes	disruptive	reset	Non-disruptive install not supported if L3 was enabled
101	yes	disruptive	reset	Non-disruptive install not supported if L3 was enabled
102	yes	disruptive	reset	Non-disruptive install not supported if L3 was enabled
103	yes	disruptive	reset	Non-disruptive install not supported if L3 was enabled
104	yes	disruptive	reset	Non-disruptive install not supported if L3 was enabled
105	yes	disruptive	reset	Non-disruptive install not supported if L3 was enabled

Images will be upgraded according to following table:

Module	Image	Running-Version	New-Version	Upg-Required
1	system	7.1(4)N1(1)	7.3(13)N1(1)	yes
1	kickstart	7.1(4)N1(1)	7.3(13)N1(1)	yes
1	bios	v3.7.0(07/28/2020)	v3.7.0(07/28/2020)	no

1	power-seq	v1.0	v1.0	no
1	fabric-power-seq	v2.0	v2.0	no
2	power-seq	v2.0	v2.0	no
3	power-seq	v2.0	v2.0	no
101	fex3	7.1(4)N1(1)	7.3(13)N1(1)	yes
102	fex3	7.1(4)N1(1)	7.3(13)N1(1)	yes
103	fex4	7.1(4)N1(1)	7.3(13)N1(1)	yes
104	fex4	7.1(4)N1(1)	7.3(13)N1(1)	yes
105	fex3	7.1(4)N1(1)	7.3(13)N1(1)	yes
1	microcontroller	v0.0.0.44	v0.0.0.44	no

Additional info for this installation:

 Remove QoS & ACL config on L3 interfaces and SVIs if any.

Step 8 Enter the **install all kickstart image system image** command on the vPC primary switch.

```
switch-1# install all system bootflash:n5500-uk9.7.3.8.N1.1.bin kickstart
bootflash:n5500-uk9-kickstart.7.3.8.N1.1.bin
```

```
Verifying image bootflash:/n5500-uk9-kickstart.7.3.8.N1.1.bin for boot variable
"kickstart".
```

```
[#####] 100% -- SUCCESS
```

```
Verifying image bootflash:/n5500-uk9.7.3.8.N1.1.bin for boot variable "system".
```

```
[#####] 100% -- SUCCESS
```

```
Verifying image type.
```

```
[#####] 100% -- SUCCESS
```

```
Extracting "system" version from image bootflash:/n5500-uk9.7.3.8.N1.1.bin.
```

```
[#####] 100% -- SUCCESS
```

```
Extracting "kickstart" version from image bootflash:/n5500-uk9-kickstart.7.3.8.N1.1.bin.
```

```
[#####] 100% -- SUCCESS
```

```
Extracting "bios" version from image bootflash:/n5500-uk9.7.3.8.N1.1.bin.
```

```
[#####] 100% -- SUCCESS
```

```
Extracting "fex3" version from image bootflash:/n5500-uk9.7.3.8.N1.1.bin.
```

```
[#####] 100% -- SUCCESS
```

```
Extracting "fex4" version from image bootflash:/n5500-uk9.7.3.8.N1.1.bin.
```

```
[#####] 100% -- SUCCESS
```

```
Performing module support checks.
```

```
[#####] 100% -- SUCCESS
```

```
Notifying services about system upgrade.
```

```
[#####] 100% -- SUCCESS
```

Compatibility check is done:

Module	bootable	Impact	Install-type	Reason
1	yes	disruptive	reset	Non-disruptive install not supported if L3 was enabled

```

      2      yes      disruptive      reset      Non-disruptive install not supported if L3
was enabled
      3      yes      disruptive      reset      Non-disruptive install not supported if L3
was enabled
     101      yes      disruptive      reset      Non-disruptive install not supported if L3
was enabled
     102      yes      disruptive      reset      Non-disruptive install not supported if L3
was enabled
     103      yes      disruptive      reset      Non-disruptive install not supported if L3
was enabled
     104      yes      disruptive      reset      Non-disruptive install not supported if L3
was enabled
     105      yes      disruptive      reset      Non-disruptive install not supported if L3
was enabled

```

Images will be upgraded according to following table:

Module	Image	Running-Version	New-Version	Upg-Required
1	system	7.1(4)N1(1)	7.3(13)N1(1)	yes
1	kickstart	7.1(4)N1(1)	7.3(13)N1(1)	yes
1	bios	v3.7.0(07/28/2020)	v3.7.0(07/28/2020)	no
1	power-seq	v1.0	v1.0	no
1	fabric-power-seq	v2.0	v2.0	no
2	power-seq	v2.0	v2.0	no
3	power-seq	v2.0	v2.0	no
101	fex3	7.1(4)N1(1)	7.3(13)N1(1)	yes
102	fex3	7.1(4)N1(1)	7.3(13)N1(1)	yes
103	fex4	7.1(4)N1(1)	7.3(13)N1(1)	yes
104	fex4	7.1(4)N1(1)	7.3(13)N1(1)	yes
105	fex3	7.1(4)N1(1)	7.3(13)N1(1)	yes
1	microcontroller	v0.0.0.44	v0.0.0.44	no

Additional info for this installation:

Remove QoS & ACL config on L3 interfaces and SVIs if any

Switch will be reloaded for disruptive upgrade.

Do you want to continue with the installation (y/n)? [n] y

Install is in progress, please wait.

Performing runtime checks.

[#####] 100% -- SUCCESS

Setting boot variables.

[#####] 100% -- SUCCESS

Performing configuration copy.

[#####] 100% -- SUCCESS

Pre-loading modules.

[This step might take upto 20 minutes to complete - please wait.]

[*Warning -- Please do not abort installation/reload or powercycle fexes*]

[#] 0%2020 Jun 9 16:25:06 AC1-N128 %\$ VDC-1 %\$

%SATCTRL-FEX101-2-SATCTRL_IMAGE: FEX101 Image update in progress.

```

2020 Jun  9 16:21:59 AC1-N128 %$ VDC-1 %$ %SATCTRL-FEX102-2-SATCTRL_IMAGE: FEX102 Image
update in progress.
2020 Jun  9 16:22:10 AC1-N128 %$ VDC-1 %$ %SATCTRL-FEX103-2-SATCTRL_IMAGE: FEX103 Image
update in progress.
2020 Jun  9 16:22:20 AC1-N128 %$ VDC-1 %$ %SATCTRL-FEX104-2-SATCTRL_IMAGE: FEX104 Image
update in progress.
2020 Jun  9 16:22:28 AC1-N128 %$ VDC-1 %$ %SATCTRL-FEX105-2-SATCTRL_IMAGE: FEX105 Image
update in progress.
[#####          ] 20%2020 Jun  9 16:28:05 AC1-N128 %$ VDC-1 %$
%SATCTRL-FEX105-2-SATCTRL_IMAGE: FEX105 Image update complete. Install pending

2020 Jun  9 16:31:32 AC1-N128 %$ VDC-1 %$ %SATCTRL-FEX101-2-SATCTRL_IMAGE: FEX101 Image
update complete.
2020 Jun  9 16:28:17 AC1-N128 %$ VDC-1 %$ %SATCTRL-FEX103-2-SATCTRL_IMAGE: FEX103 Image
update complete. Install pending
2020 Jun  9 16:28:25 AC1-N128 %$ VDC-1 %$ %SATCTRL-FEX102-2-SATCTRL_IMAGE: FEX102 Image
update complete. Install pending
2020 Jun  9 16:29:05 AC1-N128 %$ VDC-1 %$ %SATCTRL-FEX104-2-SATCTRL_IMAGE: FEX104 Image
update complete. Install pending
[#####] 100% -- SUCCESS

Finishing the upgrade, switch will reboot in 10 seconds.
AC1-N128# [ 5362.197651] Shutdown Ports..
[ 5362.200607] writing reset reason 49,
2020 Jun  9 16:33:00 AC1-N128 %$ VDC-1 %$ Jun  9 16:33:00 %KERN-0-SYSTEM_MSG: [
5362.197651] Shutdown Ports.. - kernel
2020 Jun  9 16:33:00 AC1-N128 %$ VDC-1 %$ Jun  9 16:33:00 %KERN-0-SYSTEM_MSG: [
5362.200607] writing reset reason 49, - kernel

2020 Jun  9 16:33:03 AC1-N128 %$ VDC-1 %$ %VPC-2-PEER_KEEP_ALIVE_RECV_FAIL: In domain
1000, VPC peer keep-alive receive has failed

Broadcast message from root (Thu Jun  9 16:33:05 2020):

The system is going down for reboot NOW!
INIT: Sending processes the TERM signal
Jun  9 16:33:07 %ICMPV6-3-API_FAILED icmpv6 [4010]  ipv6_client_output_with_detail()
failed in icmpv6_nd_send_ra()
Jun  9 16:33:07 %ADJMR-3-URIB_SEND_TO_ERROR Send to URIB failed: Invalid argument

INIT: Sending processes the KILL signal

Sending all processes the TERM signal...

Sending all processes the KILL signal...

Unmounting filesystems...

[ 5380.009529] Resetting board

Booting kickstart image: bootflash:/n5500-uk9-kickstart.7.3.8.N1.1.bin

.....
.....Image verification OK

Booting kernel
INIT: [ 13.586406] val:4, count7 .
[ 13.589191] TCO_TMR val:1023, SMI_EN= 0x42033  NMI_STS_CNT_REG = 0x2d count7 .
devmemfd:0x7f8a3428
phys->virt: 0x7f8a336c7f8a3428-->0x0
devmemfd:0x7f8a3468
phys->virt: 0xa44000087f8a3468-->0x0

```

```

devmemfd:0x7f8a3468
phys->virt: 0xa44000087f8a3468-->0x0
devmemfd:0x7f8a3468
phys->virt: 0xa44000087f8a3468-->0x0
Starting system POST.....
P(0x4) board
  Executing Mod 1 1 SEEPROM Test:
...done (0 sec, 175 msec, 861 usec)
  Executing Mod 1 1 GigE Port Test:
....done (16 sec, 82 msec, 150 usec)
  Executing Mod 1 1 PCIE Test:
.....done (0 sec, 1 msec, 693 usec)
  Mod 1 1 Post Completed Successfully
POST is completed
can't create lock file /var/lock/mtab-308: No such file or directory (use -n flag to
override)
nohup: redirecting stderr to stdout

Executing /etc/rc.d/rcS.d/S07firmware-upgrade-eusb

rx unmodified, ignoring

tx unmodified, ignoring

rx unmodified, ignoring

tx unmodified, ignoring

Checking all filesystems..... done.

Loading system software

Thu Jun 9 16:34:54 IST 2020 BIGSUR SYNC getting started issu = 0

Uncompressing system image: bootflash:/n5500-uk9.7.3.8.N1.1.bin Thu Jun 9 16:35:05 IST
2020

Load plugins that defined in image conf: /isan/plugin_img/img.conf
Loading plugin 0: core_plugin...
load_plugin: Can't get exclude list from /isan/plugin/0/boot/etc/plugin_exclude.conf (rc
0x40ea0017)
Loading plugin 1: eth_plugin...

ethernet switching mode

INIT: Entering runlevel: 3

touch: cannot touch `/var/lock/subsys/netfs': No such file or directory

Mounting other filesystems: [ OK ]

touch: cannot touch `/var/lock/subsys/local': No such file or directory

/isan/bin/muxif_config: fex vlan id: -f,4042
Set name-type for VLAN subsystem. Should be visible in /proc/net/vlan/config
Added VLAN with VID == 4042 to IF -:muxif:-
card index: 0x2b35
2020 Jun 9 16:35:49 AC1-N128 %$ VDC-1 %$ %SYSLOG-2-SYSTEM_MSG : Syslogs wont be logged
into logflash until logflash is online

2020 Jun 9 16:35:53 AC1-N128 %$ VDC-1 %$ %KERN-0-SYSTEM_MSG: [ 13.586406] val:4, count7
. - kernel

```

```

2020 Jun 9 16:35:53 AC1-N128 %$ VDC-1 %$ %KERN-0-SYSTEM_MSG: [ 13.589191] TCO_TMR
val:1023, SMI_EN= 0x42033 NMI_STS_CNT_REG= 0x2d count7 . - kernel

2020 Jun 9 16:36:21 AC1-N128 %$ VDC-1 %$ %USER-2-SYSTEM_MSG: CLIS: loading cmd files
begin - clis
2020 Jun 9 16:36:32 AC1-N128 %$ VDC-1 %$ %USER-2-SYSTEM_MSG: CLIS: loading cmd files end
- clis
2020 Jun 9 16:36:32 AC1-N128 %$ VDC-1 %$ %USER-2-SYSTEM_MSG: CLIS: init begin - clis

2020 Jun 9 16:36:33 AC1-N128 %$ VDC-1 %$ %DAEMON-2-SYSTEM_MSG: <<%XMLMA-2-XMLMACRIT>>
XMLmaster agent: Starting sysmgr handshake. - xmlma [4420]

2020 Jun 9 16:36:33 AC1-N128 %$ VDC-1 %$ %DAEMON-2-SYSTEM_MSG: <<%XMLMA-2-XMLMACRIT>>
XMLmaster agent: Done with sysmgr handshake. - xmlma [4420]

2020 Jun 9 16:37:40 AC1-N128 %$ VDC-1 %$ %PORT-2-IF_DOWN_ERROR_DISABLED: %$VSAN 1%$
Interface vfc1005 is down (Error disabled)

2020 Jun 9 16:37:40 AC1-N128 %$ VDC-1 %$ %PORT-2-IF_DOWN_ERROR_DISABLED: %$VSAN 3313%$
Interface vfc10301 is down (Error disabled)

2020 Jun 9 16:37:41 AC1-N128 %$ VDC-1 %$ %PORT-2-IF_DOWN_ERROR_DISABLED: %$VSAN 3312%$
Interface vfc10348 is down (Error disabled)

2020 Jun 9 16:37:41 AC1-N128 %$ VDC-1 %$ %PORT-2-IF_DOWN_ERROR_DISABLED: %$VSAN 1%$
Interface vfc1005 is down (Error disabled)

2020 Jun 9 16:37:41 AC1-N128 %$ VDC-1 %$ %PORT-2-IF_DOWN_ERROR_DISABLED: %$VSAN 3313%$
Interface vfc10301 is down (Error disabled)

2020 Jun 9 16:37:41 AC1-N128 %$ VDC-1 %$ %PORT-2-IF_DOWN_ERROR_DISABLED: %$VSAN 3312%$
Interface vfc10348 is down (Error disabled)

System is coming up ... Please wait ...

System is coming up ... Please wait ...

System is coming up ... Please wait ...

System is coming up ... Please wait ...

System is coming up ... Please wait ...

```

During the software upgrade on the primary switch, you can view the FEX upgrade progress using the vPC secondary switch (see the bold output):

```

switch-2# 2020 Jun 9 11:58:11 switch %$ VDC-1 %$ %SATCTRL-FEX130-2-SATCTRL_IMAGE: FEX101
Image update in progress.
2020 Jun 9 11:58:21 switch %$ VDC-1 %$ %SATCTRL-FEX198-2-SATCTRL_IMAGE: FEX102 Image
update in progress.
2020 Jun 9 12:03:41 switch %$ VDC-1 %$ %SATCTRL-FEX198-2-SATCTRL_IMAGE: FEX103 Image
update complete. Install pending
2020 Jun 9 12:05:49 switch %$ VDC-1 %$ %SATCTRL-FEX130-2-SATCTRL_IMAGE: FEX104 Image
update complete. Install pending

```

Verify the status of the Fabric Extender from the secondary vPC switch.

```

switch-2# show fex 101
FEX: 101 Description: FEX101 state: Online
FEX version: 7.3(13)N1(1) [Switch version: 7.3(13)N1(1)]
Extender Serial: FOC1818R2MF
Extender Model: N2K-C2348UPQ, Part No: 73-15489-03
Pinning-mode: static Max-links: 1

```



```

Fabric port for control traffic: Eth2/1
FCoE Admin: false
FCoE Oper: false
FCoE FEX AA Configured: true
Fabric interface state:
    Pol130 - Interface Up. State: Active
    Eth2/1 - Interface Up. State: Active
switch-2# show fex 102
FEX: 102 Description: FEX102 state: Online
FEX version: 7.3(13)N1(1) [Switch version: 7.3(13)N1(1)]
Extender Serial: FOC1910R0R1
Extender Model: N2K-C2332TQ-10GT, Part No: 73-16733-04
Pinning-mode: static Max-links: 1
Fabric port for control traffic: Eth2/2
FCoE Admin: false
FCoE Oper: false
FCoE FEX AA Configured: true
Fabric interface state:
    Pol198 - Interface Up. State: Active
    Eth2/2 - Interface Up. State: Active
switch-2# show fex

```

FEX Number	FEX Description	FEX State	FEX Model	Fex Serial
101	FEX0130	Online	N2K-C2348UPQ	FOC1818R2MF
102	FEX0198	Online	N2K-C2332TQ-10GT	FOC1910R0R1

**Note**

The Fabric Extender remains online on the vPC secondary switch while the vPC primary switch is reloaded.

Step 9

Ensure that the upgrade on vPC primary switch is completed. Use the **show version** command to verify the upgrade on vPC primary switch.

```

switch-1# show version
Cisco Nexus Operating System (NX-OS) Software
TAC support: http://www.cisco.com/tac
Documents: http://www.cisco.com/en/US/products/ps9372/tsd_products_support_series_home.html
Copyright (c) 2002-2020, Cisco Systems, Inc. All rights reserved.
The copyrights to certain works contained herein are owned by
other third parties and are used and distributed under license.
Some parts of this software are covered under the GNU Public
License. A copy of the license is available at
http://www.gnu.org/licenses/gpl.html.

Software
  BIOS:          version 3.7.0
  Power Sequencer Firmware:
    Module 1:    v1.0
    Module 1:    v2.0
    Module 2:    v2.0
  Fabric Power Sequencer Firmware: Module 1: version v2.0
  Microcontroller Firmware:      version v0.0.0.44
  QSFP Microcontroller Firmware:
    Module 1:    v2.0.0.0
  SFP Microcontroller Firmware:
    Module 1:    v1.1.0.0
    Module 2:    v1.10.0.0
    Module 3:    v1.10.0.0
  CXP Microcontroller Firmware:
    Module not detected

```

```
kickstart: version 7.3(13)N1(1) [build 7.3(13)N1(1)]
system:    version 7.3(13)N1(1) [build 7.3(13)N1(1)]
BIOS compile time:      07/28/2020
kickstart image file is: bootflash:///n5500-uk9-kickstart.7.3.8.N1.1.bin
kickstart compile time: 8/4/2020 3:00:00 [08/04/2020 23:47:58]
system image file is:   bootflash:///n5500-uk9.7.3.8.N1.1.bin
system compile time:    8/4/2020 3:00:00 [08/04/2020 23:49:53]
```

Hardware

```
cisco Nexus 56128P Chassis ("Nexus 56128P Supervisor")
Intel(R) CPU @ 1.80GHz
with 8243028 kB of memory.
Processor Board ID FOC173734MF
```

```
Device name: AC1-N128
bootflash:   7823360 kB
```

Kernel uptime is 0 day(s), 0 hour(s), 20 minute(s), 4 second(s)

Last reset at 44506 usecs after Thu Jun 9 16:33:05 2020

```
Reason: Disruptive upgrade
System version: 7.1(4)N1(1)
Service:
```

plugin

```
Core Plugin, Ethernet Plugin, Fc Plugin
```

Active Package(s)

Step 10 On the vPC primary switch after the upgrade, the FEXs connected to the switch are in Active/Active mismatch state.

```
switch-1# show fex
FEX          FEX          FEX          FEX          Fex
Number      Description  State         Model         Serial
-----
101         FEX101      AA Version Mismatch N2K-C2348UPQ  FOC1818R2MF
102         FEX102      AA Version Mismatch N2K-C2332TQ-10GT FOC1910R0R1
```

Step 11 On the vPC secondary switch, reload the first Fabric Extenders (reload only dual-homed FEXs) one at a time and wait for them to come online on the newly upgraded vPC primary switch before proceeding to the next FEX.

```
switch-2# reload fex 101
reload fex 101
WARNING: This command will reboot FEX 101
Do you want to continue? (y/n) [n] y
2020 Jun 9 13:49:14 switch-2 %$ VDC-1 %$ %ETH_PORT_CHANNEL-5-FOP_CHANGED: port-channel101:
first operational port changed from Ethernet2/1 to none
2020 Jun 9 13:49:14 switch-2 %$ VDC-1 %$ %ETH_PORT_CHANNEL-5-PORT_DOWN: port-channel101:
Ethernet2/1 is down
2020 Jun 9 13:49:14 switch-2 %$ VDC-1 %$ %ETH_PORT_CHANNEL-5-PORT_DOWN: port-channel101:
port-channel101 is down
2020 Jun 9 13:49:14 switch-2 %$ VDC-1 %$ %FEX-5-FEX_PORT_STATUS_NOTI: Uplink-ID 1 of Fex
101 that is connected with Ethernet2/1 changed its status from Active to Disconnected
2020 Jun 9 13:49:14 switch-2 %$ VDC-1 %$ %NOHMS-2-NOHMS_ENV_FEX_OFFLINE: FEX-101 Off-line
(Serial Number FOC1818R2MF)
2020 Jun 9 13:49:14 switch-2 %$ VDC-1 %$ %PFMA-2-FEX_STATUS: Fex 101 is offline

switch-2# reload fex 102
reload fex 102
WARNING: This command will reboot FEX 102
```

```

Do you want to continue? (y/n) [n] y
2020 Jun 9 13:49:14 switch-2 %$ VDC-1 %$ %ETH_PORT_CHANNEL-5-FOP_CHANGED: port-channel102:
first operational port changed from Ethernet2/1 to none
2020 Jun 9 13:49:14 switch-2 %$ VDC-1 %$ %ETH_PORT_CHANNEL-5-PORT_DOWN: port-channel102:
Ethernet2/1 is down
2020 Jun 9 13:49:14 switch-2 %$ VDC-1 %$ %ETH_PORT_CHANNEL-5-PORT_DOWN: port-channel102:
port-channel101 is down
2020 Jun 9 13:49:14 switch-2 %$ VDC-1 %$ %FEX-5-FEX_PORT_STATUS_NOTI: Uplink-ID 1 of Fex
102 that is connected with Ethernet2/1 changed its status from Active to Disconnected
2020 Jun 9 13:49:14 switch-2 %$ VDC-1 %$ %NOHMS-2-NOHMS_ENV_FEX_OFFLINE: FEX-102 Off-line
(Serial Number FOC1818R2MF)
2020 Jun 9 13:49:14 switch-2 %$ VDC-1 %$ %PFMA-2-FEX_STATUS: Fex 102 is offline

```

**Note**

Only the vPC primary switch shows that the Fabric Extender is online because the vPC secondary switch does not have the new image. The secondary switch shows the Fabric Extender in Active/Active version mismatch state.

```

switch-2# show fex
FEX          FEX          FEX          FEX          Fex
Number      Description  State         Model         Serial
-----
101          FEX101      AA Version Mismatch  N2K-C2348UPQ  FOC1818R2MF
102          FEX102      AA Version Mismatch  N2K-C2332TQ-10GT  FOC1910R0R1switch-2#

```

**Note**

Make sure that the first Fabric Extender comes up before reloading the subsequent Fabric Extenders on the vPC secondary switch.

When all the Fabric Extenders are loaded, go to the next step.

To upgrade the vPC secondary switch, follow [Step 2](#) to [Step 9](#).

- Step 12** Verify all the FEXs connected to the vPC secondary switch are online. Use the **show fex** command to view the FEX status.

```

switch-2# show fex
FEX          FEX          FEX          FEX          Fex
Number      Description  State         Model         Serial
-----
101          FEX101      Online        N2K-C2348UPQ  FOC1818R2MF
102          FEX102      Online        N2K-C2332TQ-10GT  FOC1910R0R1

```

**Note**

You should do certain sanity checks to ensure that the system is ready for an ISSU and to understand the impact of an ISSU.

Monitoring the Upgrade Status

[Table 8](#) lists the **show** commands that are used to monitor installation upgrades.

Table 8 **Monitoring the Upgrade Process**

Command	Definition
show fex	Displays the Fabric Extender status during an ISSU.
show install all failure-reason	Displays the applications that failed during an installation and why the installation failed.
show install all status	Displays a high-level log of the installation.
show system internal log install details	Displays detailed logs of the last installation-related command.
show system internal log install history	Displays detailed logs of the last five installation-related commands, from the oldest to the newest logs.
show tech-support	Displays the system and configuration information that you can provide to the Cisco Technical Assistance Center when reporting a problem.

The following example shows the output from the **show install all status** command:

```

There is an on-going installation...
Enter Ctrl-C to go back to the prompt.

Continuing with installation process, please wait.
The login will be disabled until the installation is completed.

Performing supervisor state verification.
SUCCESS

Supervisor non-disruptive upgrade successful.

Pre-loading modules.
SUCCESS

Module 101: Non-disruptive upgrading.
SUCCESS

Module 102: Non-disruptive upgrading.
SUCCESS

Install has been successful. (hit Ctrl-C here)

```

The following example shows the output from the **show fex** command on two vPC peer switches where FEX 101 and FEX 102 are upgraded:

```

switch-1# show fex
  FEX      FEX      FEX      FEX
Number  Description  State      Model      Serial
-----
 101      FEX101      Hitless Upg Idle  N2K-C2248TP-1GE  JAF1342ANQP
 102      FEX102      Online        N2K-C2248TP-1GE  JAF1342ANRL

switch-2# show fex
  FEX      FEX      FEX      FEX
Number  Description  State      Model      Serial
-----
 101      FEX101      FEX AA Upg Idle  N2K-C2248TP-1GE  JAF1342ANQP
 102      FEX102      Online        N2K-C2248TP-1GE  JAF1342ANRL

```

Downgrading from a Higher Release

Downgrading from Cisco NX-OS Release 7.3(13)N1(1) to any lower version using the **install all** command is the same as manually setting the boot variables and reloading the switch. Note that the downgrades are disruptive. The ASCII configuration replay for downgrade on Cisco Nexus 5500 Series switches will be enabled. You can use the **show incompatibility system** command to ensure that there are no feature incompatibilities between the current release and the target release.



Note

When you perform a disruptive downgrade using the **install-all** command, and the fabric mode is set to 40 Gigabit mode, the fabric mode will revert to 10 Gigabit mode. To restore the fabric mode to 40 Gigabit mode, configure the fabric mode to 40 Gigabit and reload the device.



Note

For FEX configurations, before performing a downgrade, the FEX configurations must be converted to use the FEX pre-provisioning configurations. For pre-provisioning a FEX, use the **slot <slot-id> provision model <model-number>** command.

After FEX pre-provisioning is done, perform the following steps to restore the configuration if the configurations contain interface breakout or unified port configurations:

1. Save the configuration to bootflash using the command **copy running-config bootflash:[directory/]filename**.
2. Use the **default interface** command to restore the default configurations of the breakout interfaces. Example: **default interface e1/49/1-4, e2/25/1-4**.
3. Save the running configuration to startup configuration using the **copy running-config startup-config** command.
4. Perform in-service software downgrade (ISSD) using the **install all** command from Cisco NX-OS Release 7.3(13)N1(1) to a lower release. In case of vPC, downgrade the primary switch first and then the secondary switch.
5. After the switch is up, power-off and power-on the module for the interface breakout to be effective. If the breakout is configured on Baseboard module, save the running configuration to startup configuration using the **copy running-config startup-config** command and then reload the switch again.
6. If breakout is not configured on the Baseboard, then an additional reload is required if running configuration contains **hardware profile route resource service-template**.
7. After the switch is up (with all the modules), copy the saved configuration from **bootflash:<filename>** to **running-config**.
8. Verify if all the interfaces are up and traffic is resumed.



Note

Before you downgrade to a specific release, check the release notes for the current release installed on the switch to ensure that your hardware is compatible with the specific release.

Troubleshooting ISSUs and Disruptive Installations

Some common causes for ISSU failure are as follows:

- ISSU requirements are not met: bridge assurance is active or the switch is not a leaf node in the STP topology. These problems are described in the “[PreInstallation Checks](#)” section on page 20.
- bootflash: does not have enough space to accept the updated image.
- The specified system and kickstart are not compatible.
- The hardware is installed or removed while the upgrade is in process.
- A power disruption occurs while the upgrade is in progress.
- The entire path for the remote server location is not specified accurately.

Related Documentation

Documentation for Cisco Nexus 5000 Series Switches and Cisco Nexus 2000 Series Fabric Extenders is available at the following URL:

http://www.cisco.com/en/US/products/ps9670/tsd_products_support_series_home.html

The documentation set includes the following types of documents:

- Licensing Information Guide
- Release Notes
- Installation and Upgrade Guides
- Configuration Guides
- Configuration Examples and TechNotes
- Programming Guides
- Operations Guides
- Error and System Message Guides
- Field Notices
- Security Advisories, Responses and Notices
- Troubleshooting Guide
- Command References
- MIB Reference Guide

Documentation Feedback

To provide technical feedback on this document or to report an error or omission, please send your comments to nexus5k-docfeedback@cisco.com. We appreciate your feedback.

Communications, Services, and Additional Information

- To receive timely, relevant information from Cisco, sign up at [Cisco Profile Manager](#).
- To get the business impact you’re looking for with the technologies that matter, visit [Cisco Services](#).
- To submit a service request, visit [Cisco Support](#).

- To discover and browse secure, validated enterprise-class apps, products, solutions and services, visit [Cisco Marketplace](#).
- To obtain general networking, training, and certification titles, visit [Cisco Press](#).
- To find warranty information for a specific product or product family, access [Cisco Warranty Finder](#).

Cisco Bug Search Tool

[Cisco Bug Search Tool](#) (BST) is a web-based tool that acts as a gateway to the Cisco bug tracking system that maintains a comprehensive list of defects and vulnerabilities in Cisco products and software. BST provides you with detailed defect information about your products and software.

© 2023 Cisco Systems, Inc. All rights reserved.

