



Cisco Nexus 1000V Installation and Upgrade Guide, Release 5.2(1)SV3(2.1)

First Published: 2016-07-08

Americas Headquarters

Cisco Systems, Inc.
170 West Tasman Drive
San Jose, CA 95134-1706
USA
<http://www.cisco.com>
Tel: 408 526-4000
800 553-NETS (6387)
Fax: 408 527-0883



CONTENTS

CHAPTER 1

Overview 1

- Information About Cisco Nexus 1000V 1
 - Virtual Supervisor Module 2
 - Virtual Ethernet Module 2
 - Information About VSM-to-VEM Communication 3
 - Layer 3 Control Mode 3
 - Layer 2 Control Mode 3
- Information About System Port Profiles and System VLANs 4
 - System Port Profiles 4
 - System VLANs 5
- Installation Overview 5
 - Installing the Cisco Nexus 1000V Manually 5
- Recommended Topologies 6
 - Topology for Layer 3 Control Mode 6
 - Topology for Layer 2 Control Mode 7
 - Control and Management VLAN Topology Options 9

CHAPTER 2

Installing the Cisco Nexus 1000V Software 11

- Installation Workflow 11
 - Steps to Install Cisco Nexus 1000V Manually 11
 - Process Flowchart for Installing the Cisco Nexus 1000V Manually 12
- Supported VMware vSphere ESXi Hypervisor Versions 13
- Prerequisites for Installing the Cisco Nexus 1000V 14
 - ESXi Host Prerequisites 14
 - VSM Prerequisites 16
 - VEM Prerequisites 16
 - Upstream Switch Prerequisites 17
- Guidelines and Limitations for Installing the Cisco Nexus 1000V 17

Information Required for Installation	19
Verifying the Authenticity of the Cisco-Signed Image (Optional)	20
Installing the Cisco Nexus 1000V Software Using ISO or OVA Files	21
Installing the VSM Software	21
Installing the Software from the ISO Image	21
Installing the Software from an OVA Image	24
Registering a vCenter Extension File in VMware vCenter	30
Establishing the SVS Connection	31
Setting Virtual Machine Startup and Shutdown Parameters	32
Adding VEM Hosts to the Cisco Nexus 1000V Distributed Virtual Switch	33
Installing the VEM Software Using VUM	36
Installing the VEM Software Using the CLI	36
Installing the VEM Software Locally on a VMware Host Using the CLI	36
Installing the VEM Software on a Stateless ESXi Host	37
Stateless ESXi Host	38
Adding the Cisco Nexus 1000V to an ESXi Image Profile	38
Installing the VEM Software on a Stateless ESXi Host Using esxcli	42
Installing the VEM Software on a Stateless ESXi Host Using VUM	44
Configuring Layer 2 Connectivity	45
Installing a VSM on the Cisco Nexus Cloud Services Platform	46
Feature History for Installing the Cisco Nexus 1000V	49

CHAPTER 3**Upgrading the Cisco Nexus 1000V 51**

Information About the Software Upgrade	51
Mixed Mode Upgrade Support	51
Upgrade Software Sources	52
Information about NetFlow Upgrade	52
Prerequisites for the Upgrade	53
Before You Begin	53
Prerequisites for Upgrading VSMs	54
Prerequisite to Upgrading a VSM to a 3-GB Hard Disk Drive	55
Upgrading Hard Disk Drive Space from 2 GB to 3 GB on a VSM as a VM	55
Upgrading Hard Disk Drive Space from 2 GB to 3 GB on a VSM on a VSB	56
Verifying that the VSM Has 3 GB of Hard Disk Drive Storage	58
Guidelines and Limitations for Upgrading the Cisco Nexus 1000V	59

Upgrade Procedures	61
Reserving the Memory and CPU on the Virtual Supervisor Module Virtual Machine	63
Reserving the Memory and CPU for the Virtual Supervisor Module in VSB on the Cloud Services Platform	64
Reserving the Memory and CPU for the Virtual Supervisor Module in VSB on the Cloud Services Platform Using the CLI	65
VSM Upgrade Procedures	66
Software Images	66
In-Service Software Upgrades on Systems with Dual VSMs	66
ISSU Process for the Cisco Nexus 1000V	67
ISSU VSM Switchover	67
ISSU Command Attributes	68
Upgrading VSMs from Releases 4.2(1)SV2(1.1) and Later Releases to Release 5.2(1)SV3(1.2) and Later Release	69
VEM Upgrade Procedures	70
Prerequisites for Upgrading VEMs	70
Upgrading Using a Customized ISO with a VMware ESX Image and a Cisco Nexus 1000V VEM Image	72
Upgrading the vCenter Server	75
Upgrading VEMs Using VUM	76
Upgrading the VEMs Using VMware Update Manager from Release 4.2(1)SV2(1.1x) and Later Releases to the Current Release	77
Accepting the VEM Upgrade	80
Upgrading the VEM Software Using the vCLI	81
Upgrading the VEMs Manually from Release 4.2(1)SV2(1.1x) and Later Releases to the Current Release	84
Combined Upgrade of VMware vSphere and Cisco Nexus 1000V	87
Required Task After Upgrade—Changing the VEM Feature Level	88
Simplified Upgrade Process	89
Migrating from Layer 2 to Layer 3	91
Layer 3 Advantages	91
Layer 2 to 3 Conversion Tool	92
About VSM-VEM Layer 2 to 3 Conversion Tool	92
Prerequisites for Using VSM-VEM Layer 2 to 3 Conversion Tool	92
Using VSM-VEM Layer 2 to 3 Conversion Tool	93

93

Using Extract Mode 94

Using Convert Mode 94

Interface Comparisons Between mgmt0 and control0 96

Configuring the Layer 3 Interface 97

Creating a Port Profile with Layer 3 Control Capability 98

Creating a VMKernel on the Host 99

Configuring the SVS Domain in the VSM 99

CHAPTER 4

Upgrading a Standalone VSM 101

Upgrading a System with a Standalone VSM 101

Upgrading a Standalone VSM 101

CHAPTER 5

Installing and Upgrading VMware 105

Upgrading from VMware Releases 5.x to VMware Release 6.0 105

Installing the vCenter Server 106

Upgrading the vSphere Client 106

Upgrading the vCenter Update Manager to Release 6.0 107

Creating a Customized Upgrade ISO with a VMware ESX Image and a Cisco Nexus 1000V
VEM Image 108

Installing VMware Release 5.x and 6.x Patches 112

Creating the Host Patch Baseline for 5.x or 6.x Patches 112

Upgrading the ESXi Hosts to Release 5.x or 6.x Patches Using VMware Update
Manager 112

Upgrading the ESXi Hosts to Release 5.x or 6.x Using the CLI 113

Upgrading the VMware DVS Version Using the VSM CLI 115

Verifying the Build Number and Upgrade 116



Overview

This chapter contains the following sections:

- [Information About Cisco Nexus 1000V, page 1](#)
- [Information About System Port Profiles and System VLANs, page 4](#)
- [Installation Overview, page 5](#)
- [Recommended Topologies, page 6](#)

Information About Cisco Nexus 1000V

The Cisco Nexus 1000V is a distributed virtual switch solution that is fully integrated within the VMware virtual infrastructure, including VMware vCenter, for the virtualization administrator. This solution offloads the configuration of the virtual switch and port groups to the network administrator to enforce a consistent data center network policy.

The Cisco Nexus 1000V is compatible with any upstream physical access layer switch that is compliant with the Ethernet standard, including the Catalyst 6500 series switch, Cisco Nexus switches, and switches from other network vendors. The Cisco Nexus 1000V is compatible with any server hardware that is listed in the [VMware Hardware Compatibility List \(HCL\)](#).



Note

We recommend that you monitor and install the patch files for the VMware ESXi host software.

The Cisco Nexus 1000V has the following components:

- Virtual Supervisor Module (VSM)—The control plane of the switch and a VM that runs Cisco NX-OS.
- Virtual Ethernet Module (VEM)—A virtual line card that is embedded in each VMware vSphere (ESXi) host. The VEM is partly inside the kernel of the hypervisor and partly in a user-world process, called the VEM Agent.

Virtual Supervisor Module

The VSM, along with the VEMs that it controls, performs the following functions for the Cisco Nexus 1000V system:

The VSM uses an external network fabric to communicate with the VEMs. The VSM runs the control plane protocols and configures the state of each VEM, but it never forwards packets. The physical NICs on the VEM server are the uplinks to the external fabric. VEMs switch traffic between the local virtual Ethernet ports that are connected to the VM vNICs but do not switch traffic to other VEMs. Instead, a source VEM switches packets to the uplinks that the external fabric delivers to the target VEM.

A single Cisco Nexus 1000V instance, including dual-redundant VSMs and managed VEMs, forms a switch domain. Each Cisco Nexus 1000V domain within a VMware vCenter Server must be distinguished by a unique integer called the domain identifier.

A single VSM can control up to 250 VEMs.

See the *Cisco Nexus 1000V Resource Availability Reference* for more information about scale limits.

The Cisco Nexus 1000V architecture is shown in the following figure.

Figure 1: Cisco Nexus 1000V Architecture

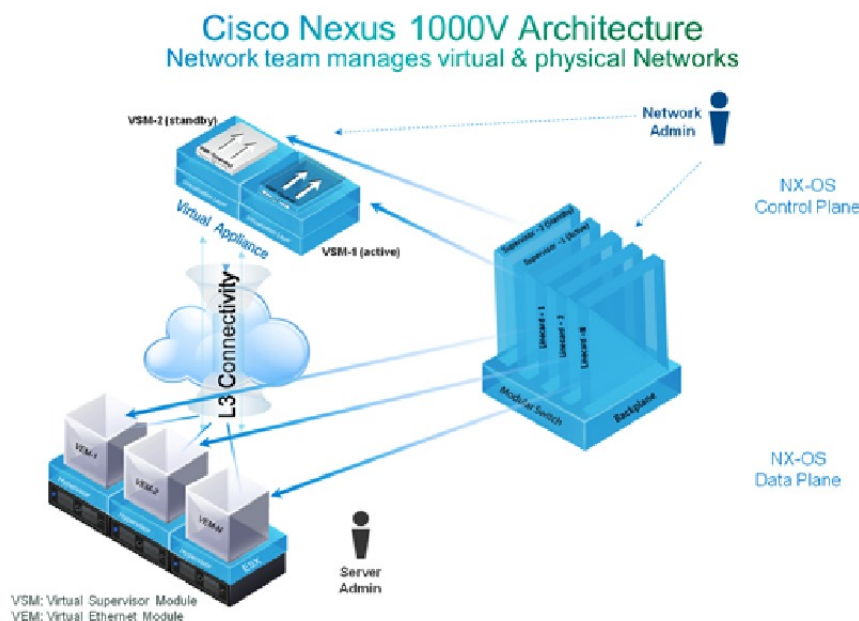

332119

Virtual Ethernet Module

Each hypervisor is embedded with one VEM that replaces the virtual switch by performing the following functions:

- Advanced networking and security

- Switching between directly attached VMs
- Uplinking to the rest of the network

**Note**

Only one version of the VEM can be installed on an ESXi host at any time.

**Note**

Cisco Nexus 1000V VEM does not support ESXi custom TCP/IP stack and control traffic through the custom TCP/IP stack.

In the Cisco Nexus 1000V, the traffic is switched between VMs locally at each VEM instance. Each VEM also interconnects the local VM with the rest of the network through the upstream access-layer network switch (blade, top-of-rack, end-of-row, and so forth). The VSM runs the control plane protocols and configures the state of each VEM accordingly, but it never forwards packets.

In the Cisco Nexus 1000V, the module slots are for the primary module 1 and secondary module 2. Either module can act as active or standby. The first server or host is automatically assigned to module 3. The network interface card (NIC) ports are 3/1 and 3/2 (vmmnic0 and vmmnic1 on the ESXi host). The ports to which the virtual NIC interfaces connect are virtual ports on the Cisco Nexus 1000V where they are assigned with a global number.

Information About VSM-to-VEM Communication

The VSM and the VEM can communicate over a Layer 2 network or a Layer 3 network. These configurations are referred to as Layer 2 or Layer 3 control modes.

Layer 3 Control Mode

Layer 3 control mode is the preferred method of communication between the VSM and the VEMs. In Layer 3 control mode, the VEMs can be in a different subnet than the VSM and from each other. Active and standby VSM control ports should be Layer 2 adjacent. These ports are used to communicate the HA protocol between the active and standby VSMs.

Each VEM needs a designated VMkernel NIC interface that is attached to the VEM that communicates with the VSM. This interface, which is called the Layer 3 Control vmknic, must have a system port profile applied to it (see [System Port Profiles, on page 4](#) and [System VLANs, on page 5](#)), so the VEM can enable it before contacting the VSM.

For a sample topology diagram, see [Topology for Layer 3 Control Mode, on page 6](#).

For more information about Layer 3 control mode, see the “Configuring the Domain” chapter in the *Cisco Nexus 1000V System Management Configuration Guide*.

Layer 2 Control Mode

In Layer 2 control mode, the VSM and VEMs are in the same subnet. You can install the VSM and VEMs on different ESXi hosts or on the same ESXi host. This figure shows a VSM and VEM that are running on the same host in Layer 2 control mode.

For a sample topology diagram showing Layer 2 control mode, see [Topology for Layer 2 Control Mode](#), on page 7.

Figure 2: VSM and VEM on the Same Host in Layer 2 Control Mode

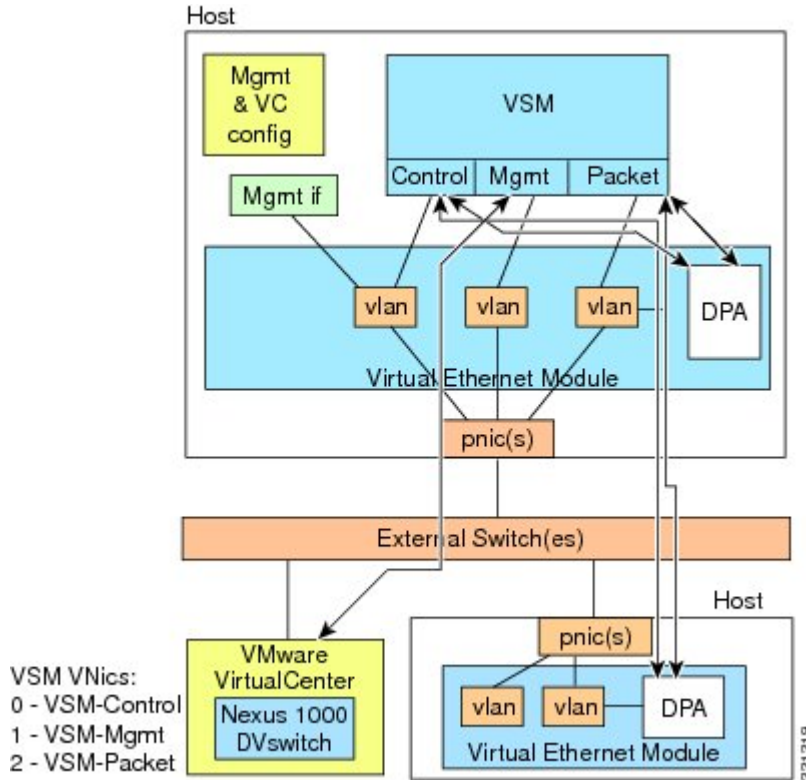

Information About System Port Profiles and System VLANs

System Port Profiles

System port profiles can establish and protect ports and VLANs that need to be configured before the VEM contacts the VSM.

When a server administrator adds a host to a DVS, its VEM must be able to contact the VSM. Because the ports and VLANs used for this communication are not yet in place, the VSM sends a minimal configuration, including the system port profiles and system VLANs, to vCenter Server, which then propagates it to the VEM.

When configuring a system port profile, you assign VLANs and designate them as system VLANs. The port profile becomes a system port profile and is included in the Cisco Nexus 1000V opaque data. Interfaces that use the system port profile, which are members of one of the defined system VLANs, are automatically enabled and forward traffic when the VMware ESX starts even if the VEM does not have communication with the VSM. The critical host functions are enabled even if the VMware ESX host starts and cannot communicate with the VSM.

**Caution**

VMkernel connectivity can be lost if you do not configure the relevant VLANs as system VLANs.

System VLANs

You must define a system VLAN in both the Ethernet and vEthernet port profiles to automatically enable a specific virtual interface to forward traffic outside the ESX host. If the system VLAN is configured only on the port profile for the virtual interface, the traffic is not forwarded outside the host. Conversely, if the system VLAN is configured only on the Ethernet port profile, the VMware VMkernel interface that needs that VLAN is not enabled by default and does not forward traffic.

The following ports must use system VLANs:

- Control and packet VLANs in the uplinks that communicate with the VSM.
- The Management VLAN in the uplinks and port profiles (that is, the Ethernet and vEthernet ports) and VMware kernel NICs used for VMware vCenter Server connectivity, Secure Shell (SSH), or Telnet connections.
- The VLAN that is used for remote storage access (iSCSI or NFS).

**Caution**

You must use system VLANs sparingly and only as described in this section. Only 32 system port profiles are supported.

After a system port profile has been applied to one or more ports, you can add more system VLANs, but you can only delete a system VLAN after you remove the port profile from service. This action prevents you from accidentally deleting a critical VLAN, such as a host management VLAN or a VSM storage VLAN.

**Note**

One VLAN can be a system VLAN on one port and a regular VLAN on another port in the same ESX host.

To delete a system VLAN, see the *Cisco Nexus 1000V Port Profile Configuration Guide*.

Installation Overview

Installing the Cisco Nexus 1000V Manually

When you install the Cisco Nexus 1000V manually, you download and install all of the necessary software. This installation method gives you the option of deploying Layer 2 or Layer 3 connectivity between the VSM and VEMs. Layer 3 connectivity is the preferred method. For an example of the Layer 3 installation topology, see [Topology for Layer 3 Control Mode](#), on page 6. If you want to use Layer 2 connectivity, see [Topology for Layer 2 Control Mode](#), on page 7.

Recommended Topologies

Topology for Layer 3 Control Mode

Layer 3 control mode is the preferred method of communication between the VSM and VEMs. This figure shows an example of a Layer 3 control mode topology where redundant VSM VMs are installed. The software for the primary VSM is installed on ESXi 1, and the software for the secondary VSM is installed on ESXi 2.

Figure 3: Layer 3 Control Mode Topology Diagram

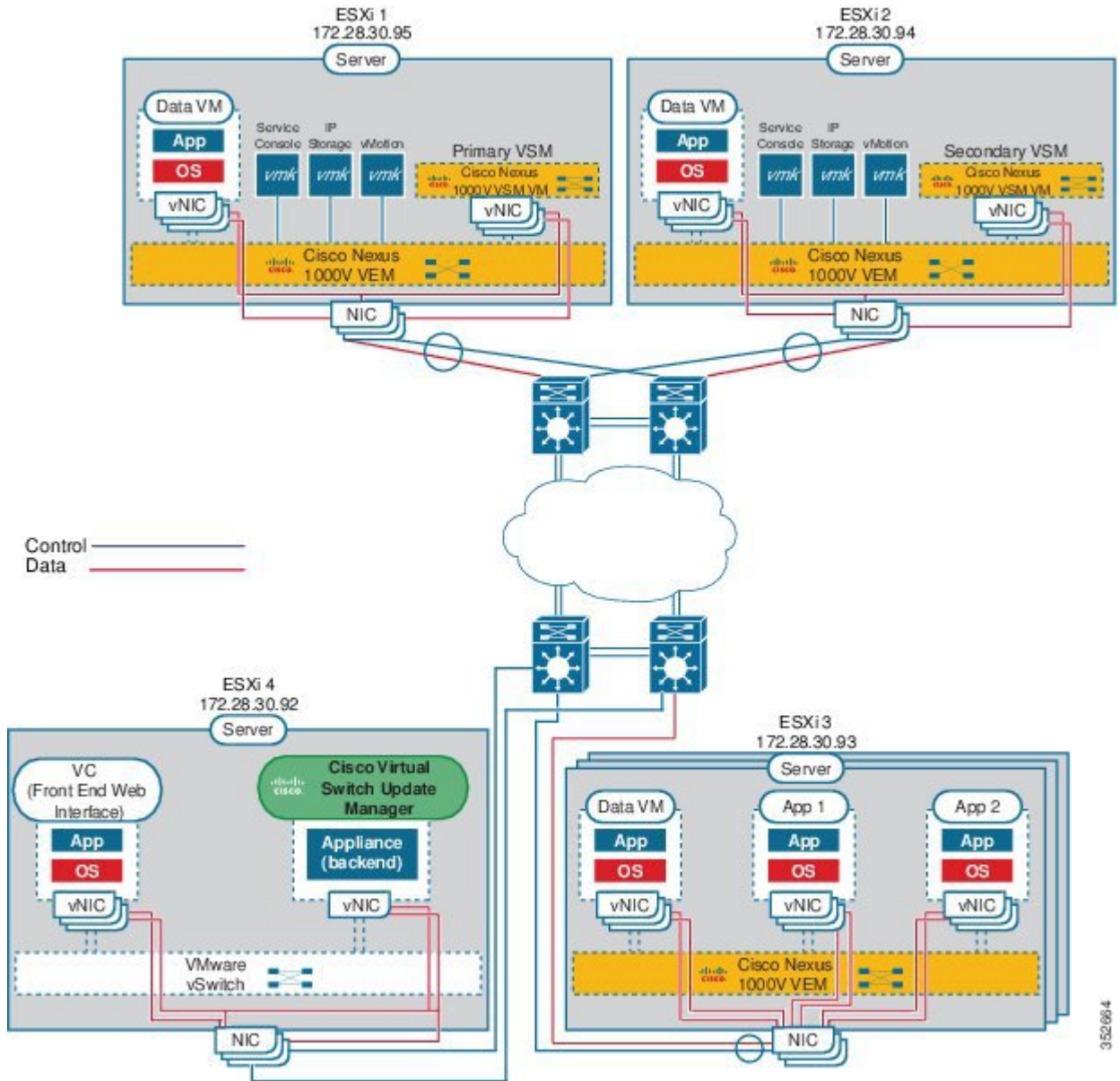

352064

Topology for Layer 2 Control Mode

**Note**

Layer 3 control mode is the preferred method for communications between the VSM and the VEMs. For a topology diagram, see [Topology for Layer 3 Control Mode](#), on page 6.

In Layer 2 control mode, the VSM and VEMs are in the same subnet. This figure shows an example of redundant VSM VMs, where the software for the primary VSM is installed on ESXi 1, and the software for the secondary VSM is installed on ESXi 2.

Figure 4: Layer 2 Control Mode Topology Diagram

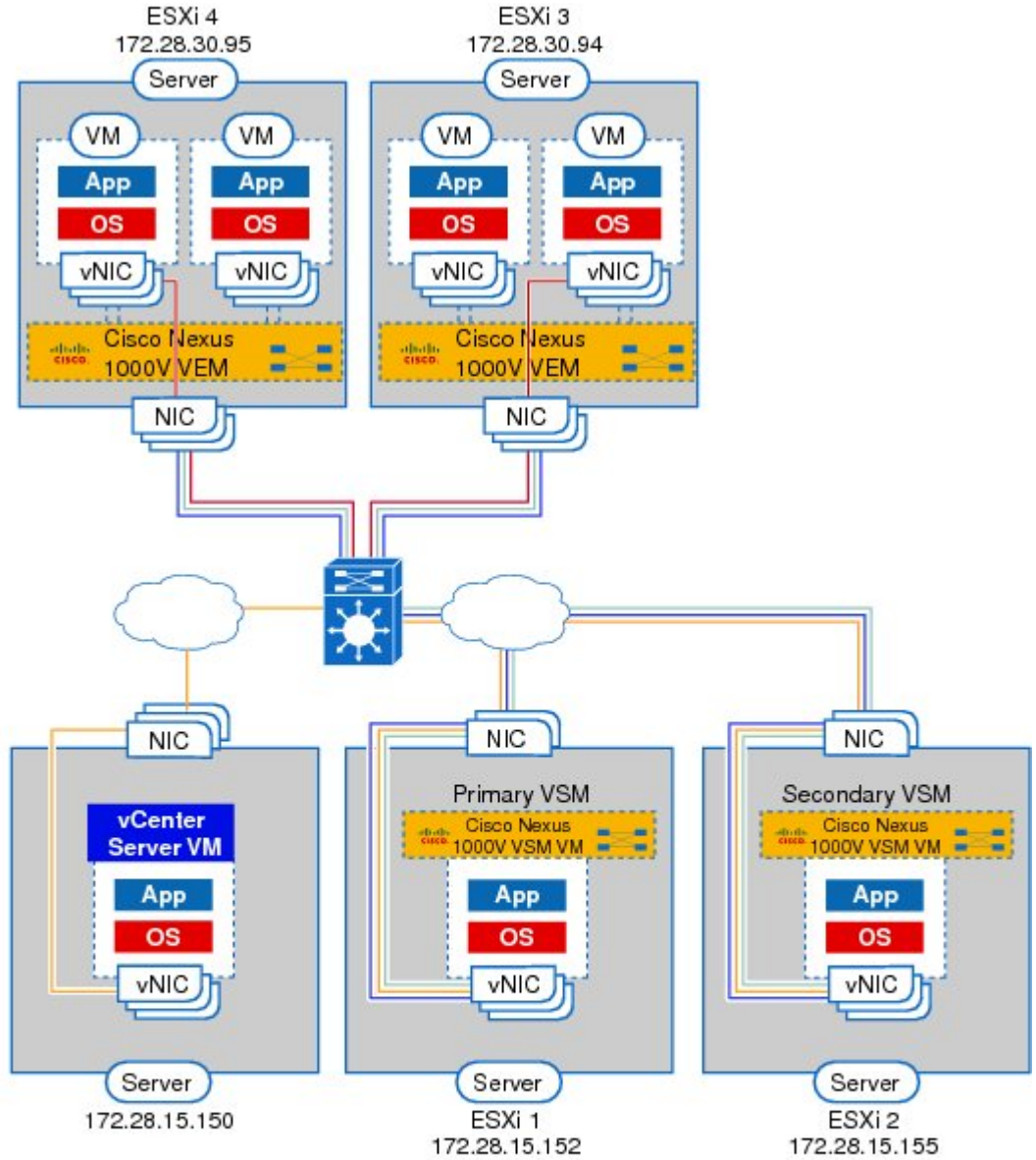

Redundant Cisco Nexus 1000V VSMs
Primary and secondary VSMs form an HA Pair

- Management ———— VLAN 260, vmnic 0
- Control ———— VLAN 260, vmnic 0
- Packet ———— VLAN 260, vmnic 0
- Data ———— VLAN 20, vmnic 1

2099903

Control and Management VLAN Topology Options

You can deploy the control and management interfaces on separate VLANs or on the same VLAN.



Installing the Cisco Nexus 1000V Software

This chapter contains the following sections:

- [Installation Workflow, page 11](#)
- [Supported VMware vSphere ESXi Hypervisor Versions, page 13](#)
- [Prerequisites for Installing the Cisco Nexus 1000V, page 14](#)
- [Guidelines and Limitations for Installing the Cisco Nexus 1000V, page 17](#)
- [Information Required for Installation, page 19](#)
- [Verifying the Authenticity of the Cisco-Signed Image \(Optional\), page 20](#)
- [Installing the Cisco Nexus 1000V Software Using ISO or OVA Files, page 21](#)

Installation Workflow

Steps to Install Cisco Nexus 1000V Manually

You can install Cisco Nexus 1000V manually. Use these high-level steps and the workflow diagram in the section to guide you through the installation process.

Procedure

- Step 1** Make sure that all of the VMware prerequisites have been met. For details, see the following sections:
- [Supported VMware vSphere ESXi Hypervisor Versions, on page 13](#)
 - [ESXi Host Prerequisites, on page 14](#)
- Step 2** Make sure that all of the Cisco Nexus 1000V prerequisites have been met. For details, see the following sections:
- [VSM Prerequisites, on page 16](#)

- [VEM Prerequisites](#), on page 16
 - [Upstream Switch Prerequisites](#), on page 17
- Step 3** Read and follow the guidelines and limitations for the Cisco Nexus 1000V.
For details, see [Guidelines and Limitations for Installing the Cisco Nexus 1000V](#), on page 17.
- Step 4** Make topology decisions and gather any necessary information.
For details, see [Information Required for Installation](#), on page 19.
- Step 5** Download the Cisco Nexus 1000V software.
- Step 6** (Optional) Verify the authenticity of the Cisco Nexus 1000V image.
For details, see [Verifying the Authenticity of the Cisco-Signed Image \(Optional\)](#), on page 20
- Step 7** Install the Virtual Supervisor Module (VSM) software from an ISO image, OVA image, or on a Cisco Nexus Cloud Services Platform.
For details, see one of the following sections:
- [Installing the Software from the ISO Image](#), on page 21
 - [Installing the Software from an OVA Image](#), on page 24
 - [Installing a VSM on the Cisco Nexus Cloud Services Platform](#), on page 46
- Step 8** If you installed the VSM software on a CSP, proceed to the next step. If you installed the VSM software on a VM using an ISO or OVA image, you need to establish the SVS connection and configure the VM startup and shutdown parameters.
For details, see [Establishing the SVS Connection](#), on page 31 and [Setting Virtual Machine Startup and Shutdown Parameters](#), on page 32.
- Step 9** Add the VEM hosts to the Distributed Virtual Switch.
For details, see [Adding VEM Hosts to the Cisco Nexus 1000V Distributed Virtual Switch](#), on page 33.
- Step 10** If you want to install the VEM software on a stateless ESXi host, proceed to the next step. Otherwise, install the VEM software using VUM, the Cisco Nexus 1000VCLI, or the VMware ESXi CLI.
For details, see one of the following sections:
- [Installing the VEM Software Using VUM](#), on page 36
 - [Installing the VEM Software Using the CLI](#), on page 36
 - [Installing the VEM Software Locally on a VMware Host Using the CLI](#), on page 36
- Step 11** Install the VEM software on a stateless ESXi host.
For more details, see [Installing the VEM Software on a Stateless ESXi Host](#), on page 37.
-

Process Flowchart for Installing the Cisco Nexus 1000V Manually

Use the procedures in this chapter and the following workflow as a guide to install the Cisco Nexus 1000V for VMware manually.

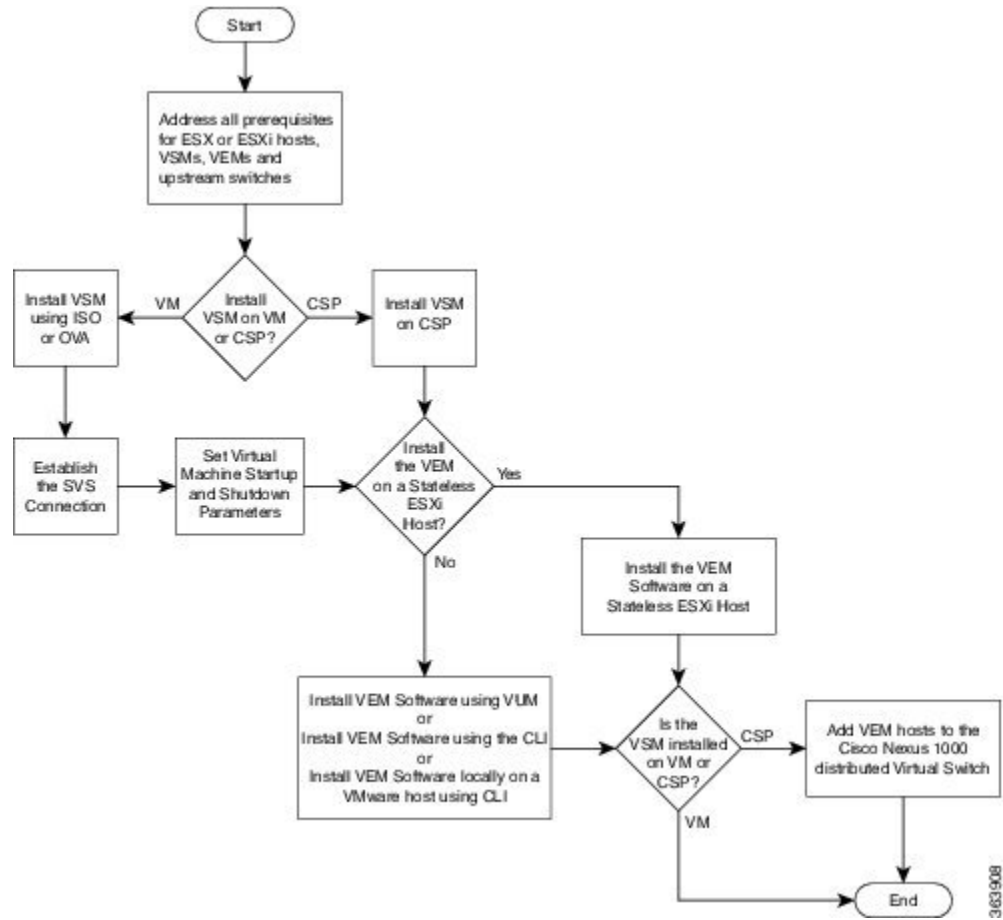

Supported VMware vSphere ESXi Hypervisor Versions

Cisco Nexus 1000V supports the following VMware vSphere ESXi Hypervisor versions:

- 6.0
- 5.5
- 5.1
- 5.0

For information about installing or upgrading the VMware software, see [Installing and Upgrading VMware, on page 105](#).

See the following table for detailed compatibility information.



Note

Do not install VMware vSphere 5.5 Patch 2702864 with Cisco Nexus 1000V. The VMware vSphere 5.5 Patch 2702864 is not supported on Cisco Nexus 1000V.

Table 1: VMware vSphere ESXi Hypervisor Software Compatibility Versions

VMware ¹	VIB ²	VEM Bundle ³	Windows VC Installer	Linux vCenter Server Appliance	VMware vSphere CLI	PowerShell CLI
ESXi 6.0	cross_cisco-vem- v300-5.2.1.3.2.1.0-6.0.1.vib	VEM600-201607300119-BG- release.zip (Offline) VEM600-201607300119-BG (Online)	6.0	6.0	6.0	6.0
ESXi 5.5 ⁴	cross_cisco-vem- v300-5.2.1.3.2.1.0-3.2.1.vib	VEM550-201607300113-BG- release.zip (Offline) VEM550-201607300113-BG (Online)	5.5	5.5	5.5	5.5
ESXi 5.1	cross_cisco-vem- v300-5.2.1.3.2.1.0-3.1.1.vib	VEM510-201607300107-BG- release.zip (Offline) VEM510-201607300107-BG (Online)	5.1	5.1	5.1	5.1
ESXi 5.0	cross_cisco-vem- v300-5.2.1.3.2.1.0-3.0.1.vib	VEM500-201607300101-BG- release.zip (Offline) VEM500-201607300101-BG (Online)	5.0	5.0	5.0	5.0

¹ Includes patches and updates.

² VIB files are available at <http://www.vmware.com/patch/download>.

³ VMware bundled software updates require placing the host in maintenance mode.

⁴ Do not install the VMware vSphere 5.5 Patch 2702864. The VMware vSphere 5.5 Patch 2702864 is not supported on Cisco Nexus 1000V.

Prerequisites for Installing the Cisco Nexus 1000V

ESXi Host Prerequisites

ESX or ESXi hosts have the following prerequisites:

- You have already installed and prepared vCenter Server for host management using the instructions from VMware.
- You should have VMware vSphere Client installed.
- You have already installed the VMware Enterprise Plus license on the hosts.
- All VEM hosts must be running ESXi 5.0 or later releases.

- You have two physical NICs on each host for redundancy. Deployment is also possible with one physical NIC.
- If you are using a set of switches, make sure that the interswitch trunk links carry all relevant VLANs, including control and packet VLANs. The uplink should be a trunk port that carries all VLANs that are configured on the host.
- You must configure control and management VLANs on the host to be used for the VSM VM.
- Make sure that the VM to be used for the VSM meets the minimum requirements listed in the following table.
- All the vmnics should have the same configuration upstream.

**Caution**

- VSM hardware version 11 is not supported. See table below for supported versions.
- The VSM VM might fail to boot if RAM and CPU are not properly allocated. This document includes procedures for allocating RAM and setting the CPU speed.

The VSM VM might fail to boot if RAM and CPU are not properly allocated. This document includes procedures for allocating RAM and setting the CPU speed.

This table lists the minimum requirements for hosting a VSM.

Table 2: Minimum Requirements for a VM Hosting a VSM

VSM VM Component	Minimum Requirement
VSM Hardware Version	7 Note VSM hardware versions 7, 8, 9, and 10 are supported. VSM hardware version 11 is not supported.
Platform	64 bit
Type	Other 64-bit Linux (recommended)
Processor	2
RAM (configured and reserved)	4 GB ⁵
NIC	3
SCSI Hard Disk	3 GB with LSI Logic Parallel adapter
CPU speed	2048 MHz ⁶

⁵ If you are installing the VSM using an OVA file, the correct RAM setting is made automatically during the installation of this file. If you are using the CD ISO image, see [Installing the Software from the ISO Image, on page 21](#) to reserve RAM and set the memory size.

⁶ If you are installing the VSM using an OVA file, the correct CPU speed setting is made automatically during the installation. If you are using the CD ISO image, see [Installing the Software from the ISO Image, on page 21](#) to reserve CPU and set the CPU reservation.

VSM Prerequisites

The Cisco Nexus 1000V VSM software has the following prerequisites:

- You have the VSM IP address.
- You have installed the appropriate vCenter Server and VMware Update Manager (VUM) versions.
- If you are installing redundant VSMs, make sure that you first install and set up the software on the primary VSM before installing and setting up the software on the secondary VSM.
- If you are using the OVA file for installation, make sure that the CPU speed is 2048 MHz or greater. If the CPU speed is less than 2048 MHz, then use ISO image for installation.
- You have already identified the HA role for this VSM from the list in the following table.

Table 3: HA Roles

HA Role	Single Supervisor System	Dual Supervisor System
Standalone (test environment only)	X	
HA		X



Note

A standalone VSM is not supported in a production environment.

- You are familiar with the Cisco Nexus 1000V topology diagram that is shown in [Topology for Layer 3 Control Mode](#), on page 6.

VEM Prerequisites

The Cisco Nexus 1000V VEM software has the following prerequisites:



Note

If VMware vCenter Server is hosted on the same ESXi host as a Cisco Nexus 1000V VEM, a VUM-assisted upgrade on the host will fail. You should manually VMotion the vCenter Server VM to another host before you perform an upgrade.

- When you perform any VUM operation on hosts that are a part of a cluster, ensure that VMware fault tolerance (FT) and VMware distributed power management (DPM) features are disabled for the entire cluster. Otherwise, VUM cannot install the hosts in the cluster.
- If the hosts are in ESXi stateless mode, enable the PXE booted ESXi host settings under **Home > Update Manager > Configuration > ESXi host/cluster**.
- You have a copy of your VMware documentation available for installing software on a host.

- You have already obtained a copy of the VEM software file.
- You have already downloaded the correct VEM software based on the current ESXi host patch level. For more information, see the *Cisco Nexus 1000V and VMware Compatibility Information*.
- For a VUM-based installation, you must deploy VUM and make sure that the VSM is connected to vCenter Server.

Upstream Switch Prerequisites

The upstream switch from the Cisco Nexus 1000V has the following prerequisites:

- If you are using a set of switches, make sure that the interswitch trunk links carry all relevant VLANs, including the control and packet VLANs. The uplink must be a trunk port that carries all the VLANs that are configured on the host.
- The following spanning tree prerequisites apply to the upstream switch from the Cisco Nexus 1000V on the ports that are connected to the VEM.
 - On upstream switches, the following configuration is mandatory:
 - On your Catalyst series switches with Cisco IOS software, enter the **spanning-tree portfast trunk** or **spanning-tree portfast edge trunk** command.
 - On your Cisco Nexus 5000 series switches with Cisco NX-OS software, enter the **spanning-tree port type edge trunk** command.
 - On upstream switches we highly recommend that you enable Global BPDU Filtering and Global BPDU Guard globally.
 - On upstream switches, where you cannot globally enable BPDU Filtering and BPDU Guard, we highly recommend that you enter the **spanning-tree bpdn filter** and **spanning-tree bpdn guard** commands.

For more information about spanning tree and its supporting commands, see the documentation for your upstream switch.

- Enter the following commands on the upstream switch:

```
show running interface interface number
interface GigabitEthernet interface number
  description description of interface
switchport
switchport trunk encapsulation dot1q
switchport trunk native VLAN native VLAN
switchport trunk allowed vlan list of VLANs
switchport mode trunk

end
```

Guidelines and Limitations for Installing the Cisco Nexus 1000V

The Cisco Nexus 1000V software installation has the following configuration guidelines and limitations:

- Virtual machine hardware version 11 is not supported.

- Do not enable VMware fault tolerance (FT) for the VSM VM because it is not supported. Instead, Cisco NX-OS HA provides high availability for the VSM.
- The VSM VM supports VMware HA. However, we strongly recommend that you deploy redundant VSMs and configure Cisco NX-OS HA between them. Use the VMware recommendations for the VMware HA.
- Do not enable VM monitoring for the VSM VM because it is not supported, even if you enable the VMware HA on the underlying host. Cisco NX-OS redundancy is the preferred method.
- When you move a VSM from the VMware vSwitch to the Cisco Nexus 1000V DVS, the connectivity between the active and standby VSM might get temporarily lost. In that situation, both active and standby VSMs assume the active role.

The reboot of the VSM is based on the following conditions:

1 The number of modules attached to the VSM

- If more modules are attached on one of the VSMs and there is no virtual channel (VC) connectivity on both VSMs, the VSM that has the smaller number of modules is rebooted.
- If modules are attached to both VSMs and one of the VSMs has VC connectivity, the VSM without connectivity is rebooted.

2 VC connectivity



Note This option is invoked when the previous condition is not met.

- If both VSMs have the same number of modules, the software makes a selection that is based on the VC connectivity status.

For example, this action is taken if both VSMs have two modules attached or both VSMs have no modules attached.

3 Last configuration change



Note This condition is invoked when the previous two conditions are not met.

- If both VSMs have the same number of modules and no VC connectivity, the VSM with the latest configuration remains active and the other VSM is rebooted.

4 Last active VSM

- If the previous three conditions are not met, the VSM that became active most recently is rebooted.

- If the VSM is moved from the VMware vSwitch to the Cisco Nexus 1000V DVS, we recommend that you configure port security on the VSM vEthernet interfaces to secure control/packet MAC addresses.
- To improve redundancy, install primary and secondary VSM VMs on separate hosts that are connected to different upstream switches.

- The Cisco Nexus 1000V VSM always uses the following three network interfaces in the same order as specified below:
 - 1 Control Interface
 - 2 Management Interface
 - 3 Packet Interface
- There is no dependency on the VM hardware version, so the VM hardware version can be upgraded if required.
- We recommend that you deploy the VMware vCenter server and VSM in the same physical data center. If you choose to deploy the vCenter server and VSM in different physical data centers, be aware of the following guidelines and limitations:
 - The VSM HA pair must be located in the same site as their storage and the active vCenter Server.
 - Layer 3 control mode is preferred.
 - If you are using Link Aggregation Control Protocol (LACP) on the VEM, use LACP offload.
 - Quality of Service bandwidth guarantees for control traffic over the DCI link.
 - Limit the number of physical data centers to two.
 - A maximum latency of 10 ms is supported for VSM-VSM control traffic when deployed across datacenters.
 - A maximum latency of 100 ms is supported for VSM-VEM control traffic for both L2 and L3 mode of deployments.
 - Cisco Nexus 1000V Release 5.2(1)SV3(1.1) and later supports deployments where vCenter and VSM are in different data centers, provided the number of hosts does not exceed 35 and the link latency does not exceed 200 ms. In these types of deployments, we recommend that you do not edit port profiles when the VSM and the vCenter are disconnected.
- We recommend that you monitor and install all the relevant patch applications from VMware ESX host server.

Information Required for Installation

Before installing the software, make topology decisions and gather any necessary information, as follows:

- Decide whether to deploy the VSM as a VM on a vSphere host or cluster or on a CSP.
- Decide whether to deploy in Layer 2 or Layer 3 control mode (Layer 3 control mode is recommended).
- For Layer 2 control mode, determine the control or packet VLANs that will be used.
- For Layer 3 control mode, decide whether the management and Layer 3 control ports will be unified or separate. If they will be separate, determine the IP address of the Layer 3 control port for each ESXi host.
- Determine the domain ID.
- Determine the management, subnet, and gateway IP addresses for the VSM.
- Determine the administrative password for the VSM.

Verifying the Authenticity of the Cisco-Signed Image (Optional)

Before you install the Nexus1000v.5.2.1.SV3.2.1.zip image, you have the option to validate the authenticity of it. In the zip file, there is a signature.txt file that contains a SHA-512 signature and an executable script that can be used to verify the authenticity of the Nexus1000v.5.2.1.SV3.2.1.zip image.



Note Verifying the authenticity of an image is optional. You can still install the image without validating its authenticity.

Before You Begin

You need to be running a Linux machine with the following utilities installed:

- openssl
- base64

Procedure

Step 1 Copy the following files to a directory on the Linux machine:

- Nexus1000v.5.2.1.SV3.2.1.zip
signature.txt file
- cisco_n1k_image_validation_v_1_1 script

Step 2 Ensure that the script is executable.
chmod 755 cisco_n1k_image_validation_v_1_1

Step 3 Run the script.
./cisco_n1k_image_validation_v_1_1 -s signature.txt Nexus1000v.5.2.1.SV3.2.1.zip

Step 4 Check the output. If the validation is successful, the following message displays:
Authenticity of Cisco-signed image Nexus1000v.5.2.1.SV3.2.1.zip has been successfully verified!

Installing the Cisco Nexus 1000V Software Using ISO or OVA Files

Installing the VSM Software

Installing the Software from the ISO Image

Before You Begin

- Know the location and image name of the ISO image you require for the installation.
- You have already read the [Prerequisites for Installing the Cisco Nexus 1000V](#), on page 14.
- You have already manually provisioned the VM to be used for the VSM. For more information, see the *VMware vSphere Virtual Machine Administration Guide*.
- The VSM VM requires the following and this procedure includes steps for updating these properties:
 - We recommend 4 Gigabit of RAM reserved and allocated.
 - We recommend 2048 MHz of CPU speed.

Procedure

-
- Step 1** Using your VMware documentation, attach the VSM ISO image to the virtual CD-ROM and copy the software to a virtual machine (VM).
- Step 2** Make sure that the VSM VM is powered off.
- Step 3** In the vSphere client **Virtual Machine Properties** window **Hardware** tab, choose **Memory**.
- Step 4** In the **Memory Size** field, choose 4 GB.
- Step 5** In the **Resources** tab, choose **Memory**.
The Resource Allocation settings display in the right-hand pane.
- Step 6** In the **Reservation** field, choose 4096 MB.
- Step 7** In the **Resources** tab, choose CPU.
The Resource Allocation settings display in the right-hand pane.
- Step 8** In the **Reservation** field, choose 2048 MHz.
Note For optimum performance, we recommend minimum 2048 MHz of CPU speed. You may change the value as per availability.
- Step 9** Click **OK**.
The VSM VM memory and CPU speed settings are saved in VMware vSphere Client.
- Step 10** Right-click the VSM and choose **Open Console**.
- Step 11** Choose **Install Nexus1000V and bring up the new image** entry and press **Enter**.
- Step 12** Enter and confirm the Administrator password.

Note All alphanumeric characters and symbols on a standard US keyboard are allowed except for these three: \$ \ ?

Step 13 Enter the domain ID.

```
Enter the domain id<1-1023>: 152
```

Step 14 Enter the HA role.

If you do not specify a role, standalone is assigned by default.

This example shows the HA role as primary.

```
Enter HA role[standalone/primary/secondary]: primary
```

```
[#####] 100%
```

```
---- Basic System Configuration Dialog ----
```

```
This setup utility will guide you through the basic configuration of
the system. Setup configures only enough connectivity for management
of the system.
```

```
*Note: setup is mainly used for configuring the system initially,
when no configuration is present. So setup always assumes system
defaults and not the current system configuration values.
```

```
Press Enter at anytime to skip a dialog. Use ctrl-c at anytime
to skip the remaining dialogs.
```

```
Would you like to enter the basic configuration dialog (yes/no):
```

Step 15 Do one of the following:

- If you are setting up the primary/active VSM, go to Step 18.
- If you are setting up the secondary/standby VSM, then continue with the next step.

Step 16 If you have set up the VSM virtual machine (VM) to boot from the CD-ROM, and are installing the secondary VSM from the ISO image attached to your CD-ROM, remove the virtual CD-ROM now so that the VSM does not boot from the CD.

This step is necessary if you have set up the VSM VM to boot from the CD-ROM before the hard drive.

Step 17 If you are setting up the secondary or standby VSM, do the following:

a) Enter the HA role at the following prompt:

```
Enter HA role[standalone/primary/secondary]:
```

b) Enter yes at the following prompt about rebooting the VSM:

```
Setting HA role to secondary will cause a system reboot. Are you sure (yes/no) ? :
```

c) Enter the domain ID at the following prompt:

```
Enter the domain id<1-1023>:
```

The secondary VSM VM is rebooted and brought up in standby mode. The password on the secondary VSM is synchronized with the password on the active/primary VSM. Any configuration made on the active/primary VSM is now automatically synchronized with the standby.

This example shows the system rebooting when the HA role is set to secondary.

```
Enter HA role[standalone/primary/secondary]: secondary
```

```
Setting HA role to secondary will cause a system reboot. Are you sure (yes/no) ? : y
```

```
Enter the domain id<1-1023>: 1020
[#####] 100%
HA mode set to secondary. Rebooting now...
You have completed this procedure for the secondary VSM.
```

- Step 18** Enter yes to enter the basic configuration dialog.
Would you like to enter the basic configuration dialog (yes/no): **yes**
- Step 19** Enter no to create another Login account.
Create another login account (yes/no) [n]: **no**
- Step 20** Enter no to configure a read-only SNMP community string.
Configure read-only SNMP community string (yes/no) [n]: **no**
- Step 21** Enter no to configure a read-write SNMP community string.
Configure read-write SNMP community string (yes/no) [n]: **no**
- Step 22** Enter a name for the switch.
Enter the switch name: **n1000v**
- Step 23** Enter yes to configure out-of-band management and then enter the mgmt0 IPv4 address and subnet mask.
Continue with Out-of-band (mgmt0) management configuration? [yes/no] [y]: **yes**
Mgmt0 IPv4 address: **172.28.15.152**
Mgmt0 IPv4 netmask: **255.255.255.0**
- Step 24** Enter yes to configure the default gateway.
Configure the default-gateway: (yes/no) [y]: **yes**
IPv4 address of the default gateway : **172.23.233.1**
- Step 25** Enter no to configure advanced IP options.
Configure Advanced IP options (yes/no)? [n]: **no**
- Step 26** Enter yes to enable the Telnet service.
Enable the telnet service? (yes/no) [y]: **yes**
- Step 27** Enter yes to enable the SSH service and then enter the key type and number of key bits.
Enable the ssh service? (yes/no) [y]: **yes**
Type of ssh key you would like to generate (dsa/rsa) : **rsa**
Number of key bits <768-2048> : **1024**
For more information, see the document, *Cisco Nexus 1000V Security Configuration Guide*.
- Step 28** Enter yes to enable the HTTP server.
Enable the http-server? (yes/no) [y]: **yes**
- Step 29** Enter no to configure the NTP server.
Configure NTP server? (yes/no) [n]: **no**
- Step 30** Enter yes to configure the SVS domain parameters and then enter the mode (L2 or L3), and the control and packet VLAN IDs.
Configure svcs domain parameters? (yes/no) [y]: **yes**
Enter SVS Control mode (L2 / L3) [L3] : Press **Return**
- Step 31** Enter yes to configure the VEM feature level and then enter 0 or 1.
Vem feature level will be set to 5.2(1)SV3(2.1),
Do you want to reconfigure? (yes/no) [n] **yes**
Current vem feature level is set to 5.2(1)SV3(2.1)
You can change the feature level to:
vem feature level is set to the highest value possible
- Note** The feature level is the least VEM release that the VSM can support. For example, if the feature level is set to the 5.2(1)SV3(1.4) release, any VEMs with an earlier release are not attached to the VSM.

The system now summarizes the complete configuration and asks if you want to edit it.

The following configuration will be applied:

```
Switchname n1000v
interface Mgmt0
ip address 172.28.15.152 255.255.255.0
no shutdown
no telnet server enable
ssh key rsa 1024 force
ssh server enable
feature http-server
svs-domain
  no control vlan
  no packet vlan
svs mode L3 interface mgmt0
```

Step 32 Do one of the following:

- If you do not want to edit the configuration enter no and continue with the next step.
- If you want to edit the configuration, enter yes and return to Step 19 to revisit each command.

```
Would you like to edit the configuration? (yes/no) [n]:no
```

Step 33 Enter yes to use and save this configuration, answer yes.

Caution If you do not save the configuration now, none of your changes will be part of the configuration the next time that the switch is rebooted. Enter yes to save the new configuration and to ensure that the kickstart and system images are also automatically configured.

```
Use this configuration and save it? (yes/no) [Y]: yes
[#####] 100%
The new configuration is saved into nonvolatile storage.
```

Note You can use the setup routine to update the configuration done in Step 18 through Step 33 at any time by entering the setup command in EXEC mode. Once setup begins, press **Enter** to skip a command. Press **Ctrl-C** to skip the remaining commands.

If you are installing redundant VSMs, make sure that you configure the software on the primary VSM before installing the software on the secondary VSM.

Step 34 Create the SVS connection manually or go to [Establishing the SVS Connection](#), on page 31.

Installing the Software from an OVA Image

Before You Begin

Before beginning this procedure, you must know or do the following:

- Know the location and image name of the OVA image you require for the installation.
- You have already read the [Prerequisites for Installing the Cisco Nexus 1000V](#), on page 14.
- You have a copy of the following Cisco Nexus 1000V software image files on your local drive, depending on the installation type you are using:
- For detailed information about using the Deploy OVF Template wizard, see the *vSphere Virtual Machine Administration Guide*.

- You have the following information available for creating a VM for the VSM and mapping the required port groups:
 - A name for the new VSM that is unique within the inventory folder and up to 80 characters.
 - The name of the host where the VSM will be installed in the inventory folder.
 - The name of the datastore in which the VM files will be stored.
 - The names of the network port groups used for the VM.
 - The Cisco Nexus 1000V VSM IP address.
- If you are using the OVA file for installation, make sure that you have the following information available for creating and saving an initial configuration file on the VSM:
 - VSM domain ID
 - Admin password
 - Management IP address, subnet mask, and gateway
- The VSM VM requires the CPU speed to be 2048 MHz or greater. If the CPU speed is less than 2048 MHz, then do not proceed with this procedure. Instead perform [Installing the Software from the ISO Image](#), on page 21.

Procedure

- Step 1** From the vSphere Client, choose **File > Deploy OVF Template**.
- Step 2** In the **Source** screen, specify the location of the OVA file and click **Next**. The OVF Template Details screen opens displaying product information, including the size of the file and the size of the VM disk.
- Step 3** Click **Next**.
- Step 4** Read the Cisco Nexus 1000V License Agreement.
- Step 5** Click **Accept** and then click **Next**.
- Step 6** In the **Name:** field, add the VSM name, choose the folder location within the inventory where it will reside, and click **Next**.
The name for the VSM must be unique within the inventory folder and less than 80 characters.
- Step 7** From the **Configuration** drop-down list, choose **Nexus 1000V Installer**.
This choice configures the primary VSM using the GUI setup dialog.
- Step 8** If you want to configure a secondary VSM, select **Nexus 1000V Secondary**.
- Step 9** Click **Next**.
- Step 10** Choose the data center or cluster on which to install the VSM.
- Step 11** Click **Next**.
- Step 12** Choose the datastore in which to store the file if one is available.
On this page, you choose from datastores already configured on the destination cluster or host. The virtual machine configuration file and virtual disk files are stored on the datastore. Choose a datastore large enough to accommodate the virtual machine and all of its virtual disk files.

Step 13 Click **Next**.

Step 14 Choose one of the following disk formats for storing virtual machine virtual disks, and click **Next**.

Format	Description
Thick Provision Lazy Zeroed	Creates a virtual disk in a default thick format. In this format, the space required for the virtual disk is allocated when the disk is created. The data remaining on the physical device is not erased during creation. The data is zeroed out on demand at a later time on first write from the virtual machine. Virtual machines do not read stale data from the physical device.
Thick Provision Eager Zeroed	Creates a virtual disk that supports clustering features such as Fault Tolerance. In this format, the space required for the virtual disk is allocated when the disk is created. The data remaining on the physical device is zeroed out when the virtual disk is created. It might take longer to create virtual disks in this format than to create other types of disks.
Thin Provision	Creates a virtual disk in thin provision format. This format is useful for saving storage space. In this format, storage blocks are allocated and zeroed out when they are first accessed. Thin provisioning is the fastest method to create a virtual disk because it creates a disk with just the header information. It does not allocate or zero out storage blocks. If the thin disk needs more space later, it can grow to its maximum capacity and occupy the entire datastore space provisioned to it.

Step 15 In the **Network Mapping** screen, choose the networks (the control, management, and packet port groups) that are present in your inventory.

Step 16 Click **Next**

Step 17 Do one of the following:

- If you are installing software on a primary VSM, specify the following properties for your primary VSM:
 - VSM domain ID
 - Admin password
 - Management IP address
 - Management IP subnet mask
 - Management IP gateway

- If you are installing software on a secondary VSM, specify only the following properties for your secondary VSM (all other properties are acquired on synchronization with the primary VSM), and then click Next:
 - VSM domain ID (use the same domain ID entered for the primary).
 - Admin password (use the same password entered for the primary).

Step 18 Click **Next**.

Step 19 In the **Ready to Complete** screen, if the configuration is correct, click **Finish**. A status bar displays as the VM installation progresses.

Step 20 Click **Close**.

You have completed installing the Cisco Nexus 1000V software.

Step 21 Right-click the VSM and choose **Open Console**.

Step 22 Click the **green arrow** to power on the VSM.

Step 23 Enter the following commands at the VSM prompt.

```
switch# configure terminal
switch(config)# setup
```

Step 24 Enter the HA role.

If you do not specify a role, standalone is assigned by default.

This example shows the HA role as primary.

```
Enter HA role[standalone/primary/secondary]: primary
```

```
[#####] 100%
```

```
---- Basic System Configuration Dialog ----
```

```
This setup utility will guide you through the basic configuration of
the system. Setup configures only enough connectivity for management
of the system.
```

```
*Note: setup is mainly used for configuring the system initially,
when no configuration is present. So setup always assumes system
defaults and not the current system configuration values.
```

```
Press Enter at anytime to skip a dialog. Use ctrl-c at anytime
to skip the remaining dialogs.
```

```
Would you like to enter the basic configuration dialog (yes/no):
```

Step 25 Do one of the following:

- If you are setting up the primary/active VSM, go to Step 18.
- If you are setting up the secondary/standby VSM, then continue with the next step.

Step 26 If you have set up the VSM virtual machine (VM) to boot from the CD-ROM, and are installing the secondary VSM from the ISO image attached to your CD-ROM, remove the virtual CD-ROM now so that the VSM does not boot from the CD.

This step is necessary if you have set up the VSM VM to boot from the CD-ROM before the hard drive.

Step 27 If you are setting up the secondary or standby VSM, do the following:

a) Enter the HA role at the following prompt:

```
Enter HA role[standalone/primary/secondary]:
```

b) Enter yes at the following prompt about rebooting the VSM:

```
Setting HA role to secondary will cause a system reboot. Are you sure (yes/no) ? :
```

c) Enter the domain ID at the following prompt:

```
Enter the domain id<1-1023>:
```

The secondary VSM VM is rebooted and brought up in standby mode. The password on the secondary VSM is synchronized with the password on the active/primary VSM. Any configuration made on the active/primary VSM is now automatically synchronized with the standby.

This example shows the system rebooting when the HA role is set to secondary.

```
Enter HA role[standalone/primary/secondary]: secondary
```

```
Setting HA role to secondary will cause a system reboot. Are you sure (yes/no) ? : y
```

```
Enter the domain id<1-1023>: 1020
```

```
[#####] 100%
```

```
HA mode set to secondary. Rebooting now...
```

```
You have completed this procedure for the secondary VSM.
```

Step 28 Enter yes to enter the basic configuration dialog.

```
Would you like to enter the basic configuration dialog (yes/no): yes
```

Step 29 Enter no to create another Login account.

```
Create another login account (yes/no) [n]: no
```

Step 30 Enter no to configure a read-only SNMP community string.

```
Configure read-only SNMP community string (yes/no) [n]: no
```

Step 31 Enter no to configure a read-write SNMP community string.

```
Configure read-write SNMP community string (yes/no) [n]: no
```

Step 32 Enter a name for the switch.

```
Enter the switch name: n1000v
```

Step 33 Enter yes to configure out-of-band management and then enter the mgmt0 IPv4 address and subnet mask.

```
Continue with Out-of-band (mgmt0) management configuration? [yes/no] [y]: yes
```

```
Mgmt0 IPv4 address: 172.28.15.152
```

```
Mgmt0 IPv4 netmask: 255.255.255.0
```

Step 34 Enter yes to configure the default gateway.

```
Configure the default-gateway: (yes/no) [y]: yes
```

```
IPv4 address of the default gateway : 172.23.233.1
```

Step 35 Enter no to configure advanced IP options.

```
Configure Advanced IP options (yes/no)? [n]: no
```

Step 36 Enter yes to enable the Telnet service.

```
Enable the telnet service? (yes/no) [y]: yes
```

Step 37 Enter yes to enable the SSH service and then enter the key type and number of key bits.

```
Enable the ssh service? (yes/no) [y]: yes
```

```
Type of ssh key you would like to generate (dsa/rsa) : rsa
```

```
Number of key bits <768-2048> : 1024
```

For more information, see the document, *Cisco Nexus 1000V Security Configuration Guide*.

Step 38 Enter yes to enable the HTTP server.

```
Enable the http-server? (yes/no) [y]: yes
```

Step 39 Enter no to configure the NTP server.

```
Configure NTP server? (yes/no) [n]: no
```

Step 40 Enter yes to configure the SVS domain parameters and then enter the mode (L2 or L3), and the control and packet VLAN IDs.

```
Configure svcs domain parameters? (yes/no) [y]: yes
```

```
Enter SVS Control mode (L2 / L3) : L2
```

```
Enter control vlan <1-3967, 4048-4093> : 100
```

```
Enter packet vlan <1-3967, 4048-4093> : 101
```

Step 41 Enter yes to configure the VEM feature level and then enter 0 or 1.

```
Vem feature level will be set to 5.2(1)SV3(2.1),
```

```
Do you want to reconfigure? (yes/no) [n] yes
```

```
Current vem feature level is set to 5.2(1)SV3(2.1)
```

```
You can change the feature level to:
```

```
vem feature level is set to the highest value possible
```

The system now summarizes the complete configuration and asks if you want to edit it.

```
The following configuration will be applied:
```

```
Switchname n1000v
interface Mgmt0
ip address 172.28.15.152 255.255.255.0
no shutdown
no telnet server enable
ssh key rsa 1024 force
ssh server enable
feature http-server
svcs-domain
svcs mode L2
control vlan 100
packet vlan 101
domain id 101
vlan 100
vlan 101
```

Step 42 Do one of the following:

- If you do not want to edit the configuration enter no and continue with the next step.
- If you want to edit the configuration, enter yes and return to Step 19 to revisit each command.

```
Would you like to edit the configuration? (yes/no) [n]: no
```

Step 43 Enter yes to use and save this configuration.

Caution If you do not save the configuration now, none of your changes will be part of the configuration the next time that the switch is rebooted. Enter yes to save the new configuration and to ensure that the kickstart and system images are also automatically configured.

```
Use this configuration and save it? (yes/no) [y]: yes
```

```
[#####] 100%
```

The new configuration is saved into nonvolatile storage.

Note You can use the setup routine to update the configuration done in Step 18 through Step 33 at any time by entering the **setup** command in EXEC mode. Once setup begins, press **Enter** to skip a command. Press **Ctrl-C** to skip the remaining commands.

Note If you are installing redundant VSMS, make sure that you configure the software on the primary VSM before installing the software on the secondary VSM.

Step 44 Register the vCenter extension file in VMware vCenter. See [Registering a vCenter Extension File in VMware vCenter](#), on page 30 for more information.

Step 45 Create the SVS connection manually or go to [Establishing the SVS Connection](#), on page 31.

Registering a vCenter Extension File in VMware vCenter

In VMware vCenter, the vCenter extension files are called plug-ins.

Before You Begin

- You know the IP address of the active VSM.
- You have already downloaded a copy of the following file from the VSM home page.

◦ cisco_nexus1000v_extension.xml



Note To go to your VSM home page, point your browser to the IP address of the active VSM.

Procedure

Step 1 Start the vSphere Client.

Step 2 From the Plug-Ins menu, choose **Manage Plug-Ins**. The Plug-In Manager dialog box opens.

Step 3 Right-click the white space within the dialog box, and choose **New Plug-In** from the popup menu. The Register Plug-In dialog box opens.

Step 4 Click **Browse** and choose the cisco_nexus1000v_extension.xml file that you downloaded from the VSM home page.

Step 5 Click **Register Plug-In**.

Step 6 In the Security Warning dialog box, click **Ignore** to continue using the certificate.

Step 7 In the Register Plug-in dialog box, click **OK**. After the plug-in is registered on vCenter, a dialog box appears stating that it has successfully registered.

Establishing the SVS Connection

Procedure

- Step 1** Open the vSphere Client.
- Step 2** Choose the primary VSM.

Figure 5: vSphere Client Window

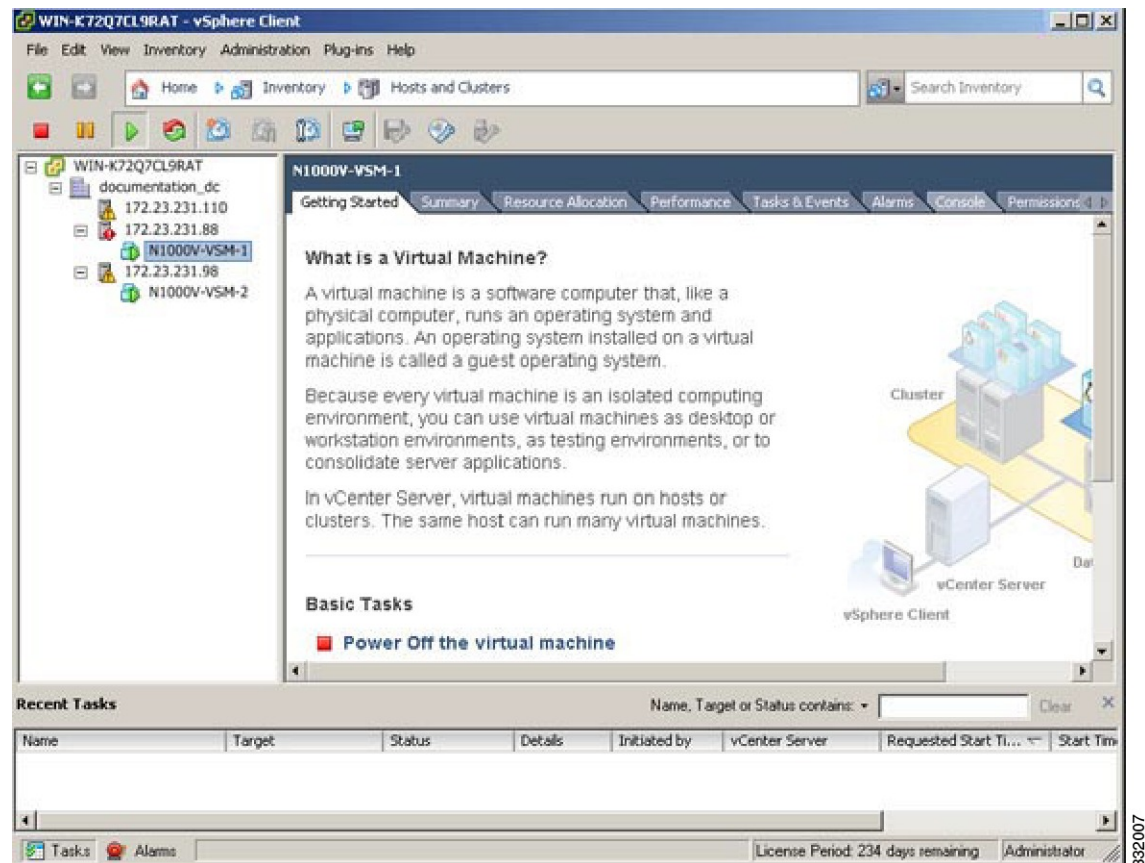

- Step 3** Choose the **Console** tab.
- Step 4** Enter the **show svcs connections** command to confirm that there is not an SVS connection.
- Step 5** Open a command window.
- Step 6** In the **VSM Console**, enter the following command:

```
svs connection <name of the connection>
  protocol vmware-vim
  remote ip address
<vc ip address> port 80
  transport type <ipv4/ipv6>
  vmware dvs datacenter-name <name>
  max-ports 50000
```

```
vmware dvs-version <4.0.0/5.0.0/5.5.0/6.0.0>
connect
```

- Step 7** In the **vSphere Console** window, enter the **show svcs connections** command. The operational status is Connected.
-

You have completed establishing the SVS connection.

Setting Virtual Machine Startup and Shutdown Parameters

Before You Begin

- You have the following information:
 - Number of seconds for the default startup delay
 - Number of seconds for the default shutdown delay

Procedure

- Step 1** In the **vSphere Client** window, choose a host and click the **Configuration** tab.
- Step 2** In the **Configuration** pane, choose **Virtual Machine Startup/Shutdown**.
- Step 3** In the **Virtual Machine Startup and Shutdown** pane, click the **Properties** link.
- Step 4** In the **System Settings** dialog box, do the following:
- a) Check the **Allow virtual machines to start and stop automatically with the system** check box.
 - b) In the System Settings pane, do the following:
 - Enter the number of seconds in the **Default Startup Delay seconds** field.
 - Enter the number of seconds in the **Default Shutdown Delay seconds** field.
 - c) In the **Startup Order** pane, do the following:
 - Choose the VM.
 - Click the **Move Up** button until the VM is under Automatic Startup.
 - d) Click **OK**.
 - e) Repeat Step 2 through Step 4 for the other VM.
-

Startup and shutdown settings are complete.

Adding VEM Hosts to the Cisco Nexus 1000V Distributed Virtual Switch

Before You Begin

- You have the following information:
 - Physical adapters
 - Uplink port groups

Procedure

- Step 1** In the vSphere Client window, choose **Hosts and Clusters** > **Networking**.

Figure 6: vSphere Client Window

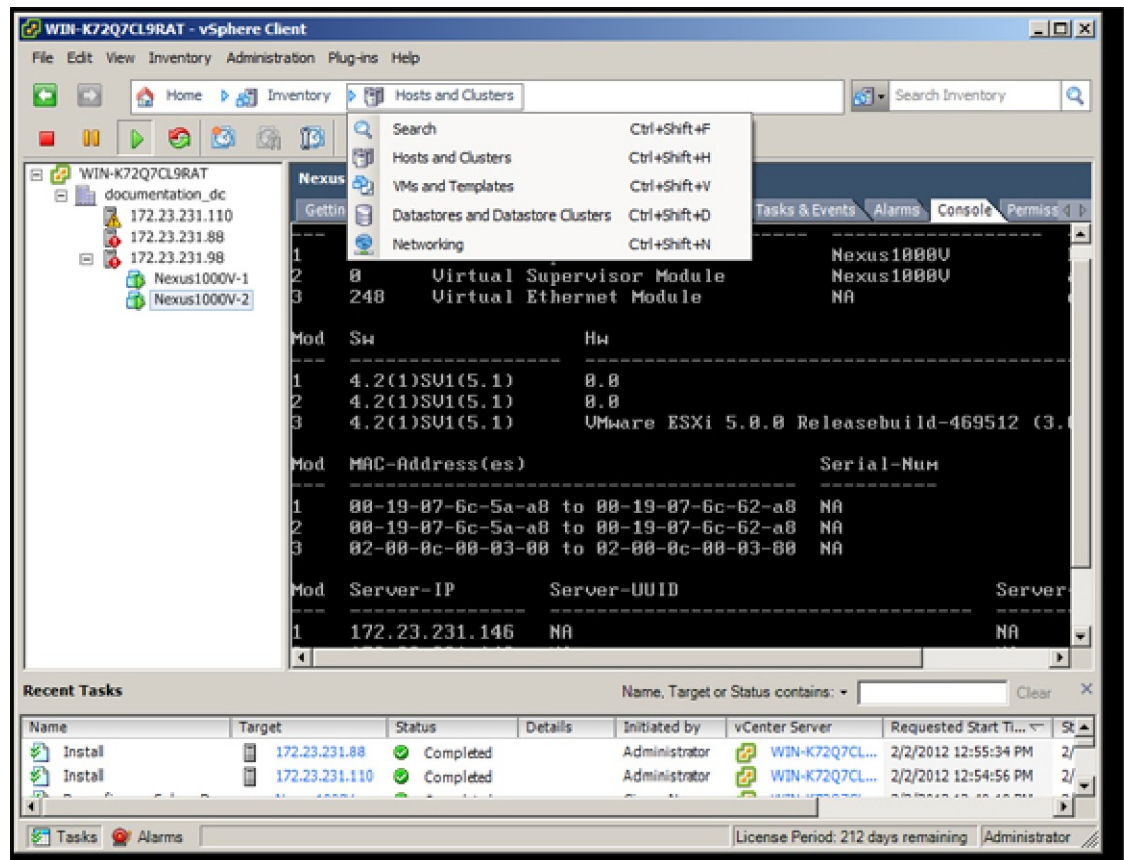

331974

Step 2 In the vSphere Client Hosts window, choose the DVS and click the **Hosts** tab.

Figure 7: vSphere Client Hosts Window

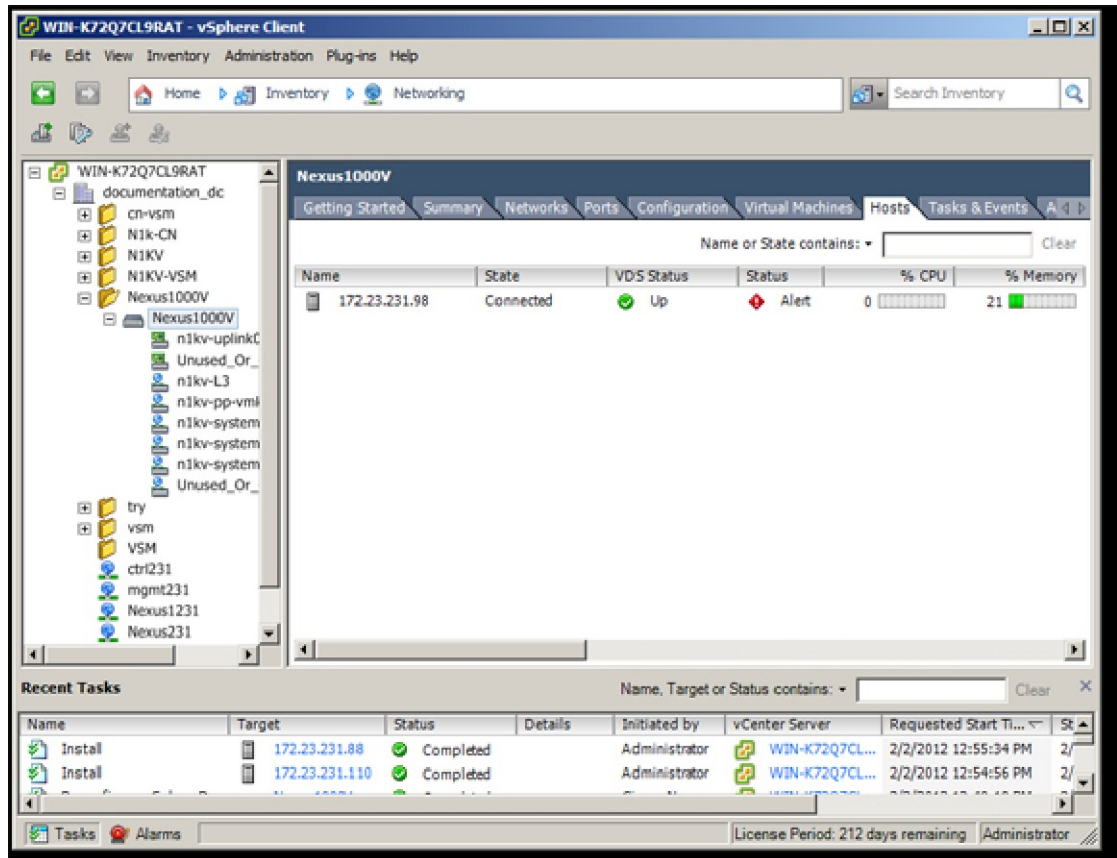

331975

Step 3 In the **Add Hosts to DVS** window, right-click the DVS and from the drop-down list, choose **Add Host**.

Figure 8: Add Hosts to DVS

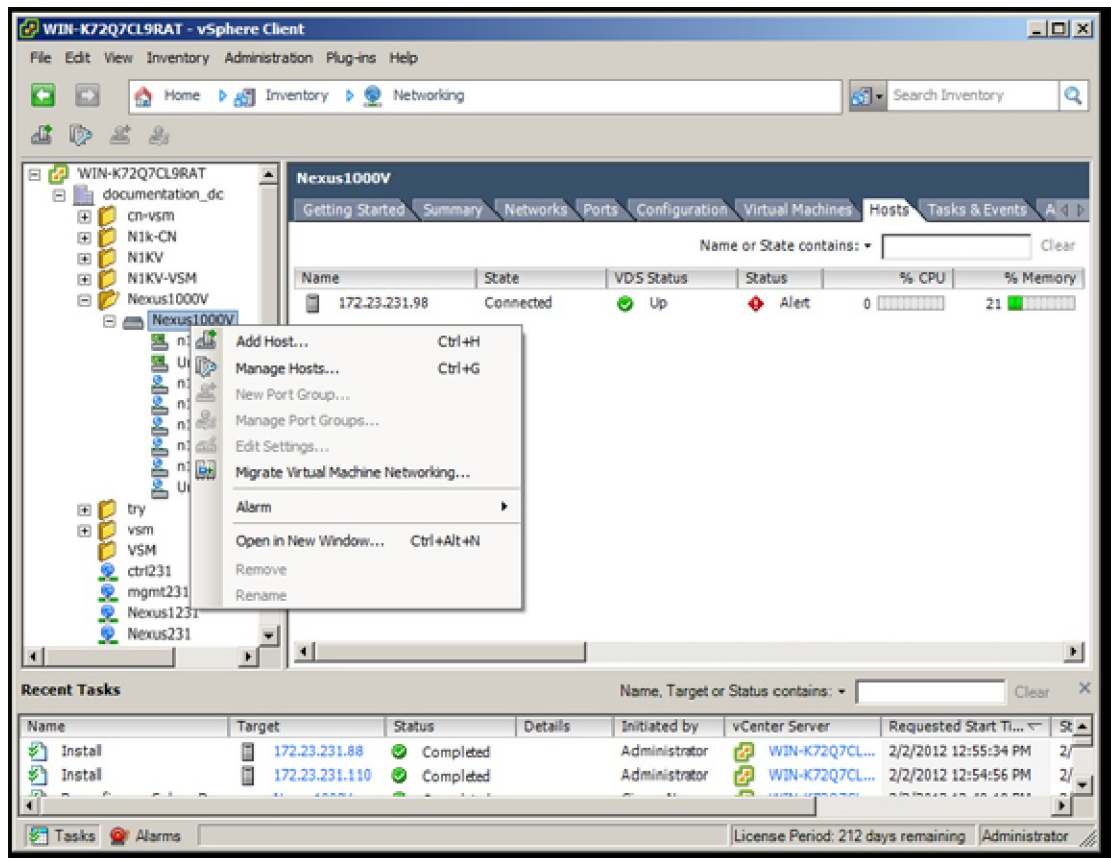

Step 4 In the **Select Hosts and Physical Adapters** screen, choose the hosts and the uplink port groups, and click **Next**.

Step 5 In the **Network Connectivity** screen, do the following tasks:

Note For Layer 3 communication, you must migrate or create a new Layer 3 vmkernel interface. Migrate your management vmkernel interface into the Layer 3 capable port-profile. Do not use multiple vmkernel interfaces on the same subnet.

- Highlight the vmkernel interface that you want to migrate, and choose the destination port group that you created for management traffic earlier.
- Click **Next**.

Step 6 In the **Virtual Machine Networking** screen, click **Next**.

Step 7 In the **Ready to Complete** screen, click **Finish**.

Step 8 In the **vSphere Client Hosts** window, confirm that the hosts are in the **Connected** state.

The host connection process is complete.

Installing the VEM Software Using VUM

Before You Begin

VMware Update Manager (VUM) automatically selects the correct VEM software to be installed on the host when the host is added to the DVS.



Note Make sure that you read the [VEM Prerequisites](#), on page 16 to ensure that the VUM operation proceeds without failure.

Installing the VEM Software Using the CLI

Based on the version of VMware ESX/ESXi software that is running on the server, there are different installation paths.

Installing the VEM Software Locally on a VMware Host Using the CLI



Note This procedure applies for VMware 5.0 host and later ESXi versions.

Procedure

-
- Step 1** Copy the VEM software to the `/tmp` directory.
- Step 2** `~ # esxcli software vib install -v /tmp/VIB_FILE`
Begin the VEM installation procedure.
- Step 3** Verify that the installation was successful by checking for the “VEM Agent (vemdpa) is running” statement in the output of the `vem status -v` command.
- Step 4** Verify that the VIB has installed by entering the following command:
`esxcli software vib list | grep cisco`
- Step 5** Verify VEM and VSM version by entering the following command:
`vem show version`
- Step 6** Verify the VSM to check that the module is online by entering the following command:
`vem vesion -v`
- Step 7** Do one of the following:
- If the installation was successful, the installation procedure is complete.
 - If the installation was not successful, see the "Recreating the Cisco Nexus 1000V Installation" section in the *Cisco Nexus 1000V Troubleshooting Guide*.
-

The following example shows how to install VEM software locally on a VMware 5.5 host using the CLI.

```

~ # esxcli software vib install -v /Cisco_bootbank_cisco-vem-v300-5.2.1.3.2.1.0-3.2.1.vib
Installation Result
Message: Operation finished successfully.
Reboot Required: false
VIBs Installed: Cisco_bootbank_cisco-vem-v300-5.2.1.3.2.1.0-3.2.1
VIBs Removed: Cisco_bootbank_cisco-vem-v198-esx_5.2.1.3.1.6.0-3.2.1
VIBs Skipped:
~ # vem status -v
Version 5.2.1.3.2.1.0-3.2.1
Build 1
Date Wed Feb 17 16:27:37 PST 2016

VEM modules are loaded

Switch Name      Num Ports  Used Ports  Configured Ports  MTU  Uplinks
vSwitch0         2432       6           128               1500 vmnic0
DVS Name         Num Ports  Used Ports  Configured Ports  MTU  Uplinks
BL               1024       18          1024              1500 vmnic5,vmnic4,vmnic7

VEM Agent (vemdpa) is running

~ #

~ # esxcli software vib list | grep cisco
cisco-vem-v300-esx          5.2.1.3.2.1.0-3.2.1          Cisco  PartnerSupported
  2016-07-05

~ #

~ # vemcmd show version
VEM Version: 5.2.1.3.2.1.0-3.2.1
VSM Version: 5.2(1)SV3(2.1)
System Version: VMware ESXi 5.5.0 Releasebuild-2068190
ESX Version Update Level: 2
~ #

```

Installing the VEM Software on a Stateless ESXi Host

The following list outlines the VEM installation process on a stateless ESXi host.

Procedure

-
- Step 1** See the procedure for [Adding the Cisco Nexus 1000V to an ESXi Image Profile](#), on page 38.
- Step 2** Installing the VEM software using one of the two following procedures:
- [Installing the VEM Software on a Stateless ESXi Host Using esxcli](#), on page 42
 - [Installing the VEM Software on a Stateless ESXi Host Using VUM](#), on page 44
- Step 3** See the procedure for [Configuring Layer 2 Connectivity](#), on page 45.
-

Stateless ESXi Host



Note For stateless ESXi, the VLAN that you use for the Preboot Execution Environment (gPXE) and Management must be a native VLAN in the Cisco Nexus 1000V management uplink. It must also be a system VLAN on the management VMkernel NIC and on the uplink.

VMware vSphere 5.0.0 introduces the VMware Auto Deploy, which provides the infrastructure for loading the ESXi image directly into the host's memory. The software image of a stateless ESXi is loaded from the Auto Deploy Server after every boot. In this context, the image with which the host boots is identified as the image profile.

An image profile is a collection of vSphere Installation Bundles (VIBs) required for the host to operate. The image profile includes base VIBs from VMware and additional VIBs from partners.

On a stateless host, you can install or upgrade the VEM software using either the VUM or CLI.

In addition, you should bundle the new or modified VEM in the image profile from which the stateless host boots. If it is not bundled in the image profile, the VEM does not persist across reboots of the stateless host.

For more information about the VMware Auto Deploy Infrastructure and stateless boot process, see the "Installing ESXi using VMware Auto Deploy" chapter of the *vSphere Installation and Setup, vSphere 5.0.0* document.

Adding the Cisco Nexus 1000V to an ESXi Image Profile

Before You Begin

- Install and set up the VMware Auto Deploy Server. See the *vSphere Installation and Setup* document.
- Install the VMware PowerCLI on a Windows platform. This step is required for bundling the VEM into the image profile. For more information, see the *vSphere PowerCLI Installation Guide*.
- On the same Windows platform where VMware PowerCLI is installed, do the following:
 - Download the image profile offline bundle, which is a ZIP file, to a local file path.
 - Download the VEM offline bundle, which is a ZIP file, to a local file path.

Procedure

-
- Step 1** Start the vSphere PowerCLI application.
- Step 2** Connect to vCenter Server by entering the following command:
Connect-VIServer *IP_address* **-User Administrator -Password XXXXX**.
- Step 3** Load the image profile offline bundle by entering the following command:
Add-ESXSoftwareDepot *image_profile_bundle*
- Note** Each image profile bundle can include multiple image profiles.
- Step 4** List the image profiles by entering the following command:

[vSphere PowerCLI] > **Get-EsxImageProfile**

- Step 5** Choose the image profile into which the VEM is to be bundled by entering the following command:
New-EsxImageProfile -CloneProfile *image_profile_name* -Name n1kv-Image
- Note** The image profiles are in read-only format. You must clone the image profile before adding the VEM into it. The n1kv-Image is the cloned image profile of the ESXi-5.0.0-standard.
- Step 6** change to Load the Cisco Nexus 1000V offline bundle by entering the following command:
Add-EsxSoftwareDepot *VEM_bundle*
- Note** The offline bundle is a zip file that includes the n1kv-vib file.
- Step 7** Confirm that the n1kv-vib package is loaded by entering the following command:
Get-EsxSoftwarePackage -Name *cisco**
- Step 8** Bundle the n1kv-package into the cloned image profile by entering the following command:
Add-EsxSoftwarePackage -ImageProfile n1kv-Image -SoftwarePackage *n1kv_package_name*
- Step 9** List all the VIBs into the cloned image profile by entering the following command:
- a) **\$img = Get-EsxImageProfile n1kv-Image**
 - b) **\$img.vibList**
- Step 10** Export the image profile to a depot file for future use by entering the following command:
Export-EsxImageProfile -ImageProfile n1kv-Image -FilePath C:\n1kv-Image.zip -ExportToBundle
- Step 11** Set up the rule for the host to boot with the image profile by entering the following commands
- Note** Any of the host parameters, such as the MAC address, IPV4 IP address, or domain name, can be used to associate an image profile with the host.
- a) **New-deployrule -item \$img -name rule-test -Pattern "mac=00:50:56:b6:03:c1"**
 - b) **Add-DeployRule -DeployRule rule-test**
- Step 12** Display the configured rule to make sure that the correct image profile is associated with the host by entering the following command:
Get-DeployRuleSet
- Step 13** Reboot the host.
 The host contacts the Auto-Deploy Server and presents the host boot parameters. The Auto Deploy server checks the rules to find the image profile associated with this host and loads the image to the host's memory. The host boots from the image.

This example shows how to add the Cisco Nexus 1000V to an ESXi image profile:



Note The examples in the procedure may contain Cisco Nexus 1000V versions and filenames that are not relevant to your release. Refer to the *Cisco Nexus 1000V and VMware Compatibility Information* for your specific versions and filenames.

```
vSphere PowerCLI> Set-ExecutionPolicy unrestricted
```

```
Execution Policy Change
The execution policy helps protect you from scripts that you do not trust.
Changing the execution policy might expose you to the security risks described
in the about_Execution_Policies help topic. Do you want to change the execution
```

```

policy?
[Y] Yes [N] No [S] Suspend [?] Help (default is "Y"): Y
vSphere PowerCLI> Connect-VIServer 10.105.231.40 -User administrator -Password 'xxxxxxxx'

```

Working with multiple default servers?

Select [Y] if you want to work with more than one default servers. In this case, every time when you connect to a different server using Connect-VIServer, the new server connection is stored in an array variable together with the previously connected servers. When you run a cmdlet and the target servers cannot be determined from the specified parameters, the cmdlet runs against all servers stored in the array variable.

Select [N] if you want to work with a single default server. In this case, when you run a cmdlet and the target servers cannot be determined from the specified parameters, the cmdlet runs against the last connected server.

WARNING: WORKING WITH MULTIPLE DEFAULT SERVERS WILL BE ENABLED BY DEFAULT IN A FUTURE RELEASE. You can explicitly set your own preference at any time by using the DefaultServerMode parameter of Set-PowerCLIConfiguration.

```
[Y] Yes [N] No [S] Suspend [?] Help (default is "Y"): Y
```

Name	Port	User
10.105.231.40	443	administrator

```
vSphere PowerCLI> Add-EsxSoftwareDepot 'C:\Documents and Settings\Administrator\Desktop\upgrade\229\VEM550-201607300113-BG-release.zip'
```

Depot Url

```
zip:C:\Documents and Settings\Administrator\Desktop\upgrade\229\VMware-ESXi-...
```

```
vSphere PowerCLI> Get-EsxImageProfile
```

Name	Vendor	Last Modified	Acceptance Level
ESXi-5.1.0-20121201001s-no-...	VMware, Inc.	12/7/2015 7:...	PartnerSupported
CN1-CY	CISCO	4/22/2015 11:...	PartnerSupported
ESXi-5.1.0-20121204001-stan...	VMware, Inc.	12/7/2015 7:...	PartnerSupported
ESXi-5.1.0-20121201001s-sta...	VMware, Inc.	12/7/2015 7:...	PartnerSupported
ESXi-5.1.0-799733-no-tools	VMware, Inc.	8/12/2015 3:0...	PartnerSupported
ESXi-5.1.0-20121204001-no-t...	VMware, Inc.	12/7/2015 7:...	PartnerSupported
ESXi-5.1.0-799733-standard	VMware, Inc.	8/12/2015 3:0...	PartnerSupported

```
vSphere PowerCLI> New-EsxImageProfile -CloneProfile ESXi-5.1.0-799733-standard -Name FINAL
```

cmdlet New-EsxImageProfile at command pipeline position 1

Supply values for the following parameters:

(Type !? for Help.)

Vendor: CISCO

Name	Vendor	Last Modified	Acceptance Level
FINAL	CISCO	2/12/2015 3:0...	PartnerSupported

```
vSphere PowerCLI> Add-EsxSoftwareDepot 'C:\Documents and Settings\Administrator\Desktop\upgrade\229\VEM550-201607300113-BG-release.zip'
```

Depot Url

```
zip:C:\Documents and Settings\Administrator\Desktop\upgrade\229\cisco-vem-v1...
```

```
vSphere PowerCLI> Get-EsxSoftwarePackage cisco*
```

Name	Version	Vendor	Creation Date
cisco-vem-v300	5.2.1.3.2.1.0-3.2.1	Cisco Partner Supported	2016-04-07

~ #

```
vSphere PowerCLI> Add-EsxSoftwarePackage -SoftwarePackage cisco-vem-v300-esx -ImageProfile FINAL
```

Name	Vendor	Last Modified	Acceptance Level
FINAL	CISCO	02/02/2016 3:...	PartnerSupported

```
vSphere PowerCLI> $img = Get-EsxImageProfile FINAL
```

Name	Version	Vendor	Creation Date
scsi-bnx2i	1.9.1d.v50.1-5vmw.510.0.0.7...	VMware	8/12/2015 ...
sata-sata-promise	2.12-3vmw.510.0.0.799733	VMware	8/12/2015 ...
net-forcedeth	0.61-2vmw.510.0.0.799733	VMware	8/12/2015 ...
esx-xserver	5.1.0-0.0.799733	VMware	8/12/2015 ...
misc-cnic-register	1.1-1vmw.510.0.0.799733	VMware	8/12/2015 ...
net-tg3	3.110h.v50.4-4vmw.510.0.0.7...	VMware	8/12/2015 ...
scsi-megaraid-sas	5.34-4vmw.510.0.0.799733	VMware	8/12/2015 ...
scsi-megaraid-mbox	2.20.5.1-6vmw.510.0.0.799733	VMware	8/12/2015 ...
scsi-ips	7.12.05-4vmw.510.0.0.799733	VMware	8/12/2015 ...
net-e1000e	1.1.2-3vmw.510.0.0.799733	VMware	8/12/2015 ...
sata-ahci	3.0-13vmw.510.0.0.799733	VMware	8/12/2015 ...
sata-sata-svw	2.3-3vmw.510.0.0.799733	VMware	8/12/2015 ...
net-cnic	1.10.2j.v50.7-3vmw.510.0.0....	VMware	8/12/2015 ...
net-e1000	8.0.3.1-2vmw.510.0.0.799733	VMware	8/12/2015 ...
ata-pata-serverworks	0.4.3-3vmw.510.0.0.799733	VMware	8/12/2015 ...
scsi-mptspi	4.23.01.00-6vmw.510.0.0.799733	VMware	8/12/2015 ...
ata-pata-hpt3x2n	0.3.4-3vmw.510.0.0.799733	VMware	8/12/2015 ...
net-s2io	2.1.4.13427-3vmw.510.0.0.79...	VMware	8/12/2015 ...
esx-base	5.1.0-0.0.799733	VMware	8/12/2015 ...
net-vmxnet3	1.1.3.0-3vmw.510.0.0.799733	VMware	8/12/2015 ...
net-bnx2	2.0.15g.v50.11-7vmw.510.0.0...	VMware	8/12/2015 ...
cisco-vem-v260-esx	5.2.1.3.1.15.0-3.2.1	Cisco	8/12/2015 ...
scsi-megaraid2	2.00.4-9vmw.510.0.0.799733	VMware	8/12/2015 ...
ata-pata-amd	0.3.10-3vmw.510.0.0.799733	VMware	8/12/2015 ...
ipmi-ipmi-si-drv	39.1-4vmw.510.0.0.799733	VMware	8/12/2015 ...
scsi-lpfc820	8.2.3.1-127vmw.510.0.0.799733	VMware	8/12/2015 ...
ata-pata-atiixp	0.4.6-4vmw.510.0.0.799733	VMware	8/12/2015 ...
esx-dvfilter-generic-...	5.1.0-0.0.799733	VMware	8/12/2015 ...
net-sky2	1.20-2vmw.510.0.0.799733	VMware	8/12/2015 ...
scsi-qla2xxx	902.k1.1-9vmw.510.0.0.799733	VMware	8/12/2015 ...
net-r8169	6.011.00-2vmw.510.0.0.799733	VMware	8/12/2015 ...
sata-sata-sil	2.3-4vmw.510.0.0.799733	VMware	8/12/2015 ...
scsi-mpt2sas	10.00.00.00-5vmw.510.0.0.79...	VMware	8/12/2015 ...
sata-ata-piix	2.12-6vmw.510.0.0.799733	VMware	8/12/2015 ...
scsi-hpsa	5.0.0-21vmw.510.0.0.799733	VMware	8/12/2015 ...
ata-pata-via	0.3.3-2vmw.510.0.0.799733	VMware	8/12/2015 ...
scsi-aacraid	1.1.5.1-9vmw.510.0.0.799733	VMware	8/12/2015 ...
scsi-rste	2.0.2.0088-1vmw.510.0.0.799733	VMware	8/12/2015 ...
ata-pata-cmd64x	0.2.5-3vmw.510.0.0.799733	VMware	8/12/2015 ...
ima-qla4xxx	2.01.31-1vmw.510.0.0.799733	VMware	8/12/2015 ...
net-igb	2.1.11.1-3vmw.510.0.0.799733	VMware	8/12/2015 ...
scsi-qla4xxx	5.01.03.2-4vmw.510.0.0.799733	VMware	8/12/2015 ...
block-cciss	3.6.14-10vmw.510.0.0.799733	VMware	8/12/2015 ...
scsi-aic79xx	3.1-5vmw.510.0.0.799733	VMware	8/12/2015 ...
tools-light	5.1.0-0.0.799733	VMware	8/12/2015 ...
uhci-usb-uhci	1.0-3vmw.510.0.0.799733	VMware	8/12/2015 ...
sata-sata-nv	3.5-4vmw.510.0.0.799733	VMware	8/12/2015 ...
sata-sata-sil24	1.1-1vmw.510.0.0.799733	VMware	8/12/2015 ...
net-ixgbe	3.7.13.6iov-10vmw.510.0.0.7...	VMware	8/12/2015 ...
ipmi-ipmi-msghandler	39.1-4vmw.510.0.0.799733	VMware	8/12/2015 ...
scsi-adp94xx	1.0.8.12-6vmw.510.0.0.799733	VMware	8/12/2015 ...
scsi-fnic	1.5.0.3-1vmw.510.0.0.799733	VMware	8/12/2015 ...
ata-pata-pdc2027x	1.0-3vmw.510.0.0.799733	VMware	8/12/2015 ...
misc-drivers	5.1.0-0.0.799733	VMware	8/12/2015 ...
net-enic	1.4.2.15a-1vmw.510.0.0.799733	VMware	8/12/2015 ...
net-be2net	4.1.255.11-1vmw.510.0.0.799733	VMware	8/12/2015 ...
net-nx-nic	4.0.558-3vmw.510.0.0.799733	VMware	8/12/2015 ...

```

esx-xlibs                5.1.0-0.0.799733          VMware      8/12/2015 ...
net-bnx2x                1.61.15.v50.3-1vmw.510.0.0.... VMware      8/12/2015 ...
ehci-ehci-hcd           1.0-3vmw.510.0.0.799733   VMware      8/12/2015 ...
ohci-usb-ohci           1.0-3vmw.510.0.0.799733   VMware      8/12/2015 ...
net-r8168                8.013.00-3vmw.510.0.0.799733 VMware      8/12/2015 ...
esx-tboot               5.1.0-0.0.799733          VMware      8/12/2015 ...
ata-pata-sil680         0.4.8-3vmw.510.0.0.799733   VMware      8/12/2015 ...
ipmi-ipmi-devintf       39.1-4vmw.510.0.0.799733   VMware      8/12/2015 ...
scsi-mptsas             4.23.01.00-6vmw.510.0.0.799733 VMware      8/12/2015 ...

```

```

vSphere PowerCLI> Export-ESXImageProfile -ImageProfile FINAL -FilePath 'C:\Documents and
Settings\Administrator\Desktop\FINAL.zip' -ExportToBundle
vSphere PowerCLI> New-deployrule -item $img -name rule-test -Pattern "mac=00:50:16:26:13:c2"
vSphere PowerCLI] > Add-DeployRule -DeployRule rule-test
[vSphere PowerCLI] > Get-DeployRuleSet
Name : rule-test
PatternList : {mac=00:50:16:26:13:c2}
ItemList : {FINAL}

```

Installing the VEM Software on a Stateless ESXi Host Using esxcli

Before You Begin

- When you enter the **esxcli software vib install** command on an ESXi 5.0.0 host, note that the following message appears:

Message: WARNING: Only live system was updated, the change is not persistent.

Procedure

-
- Step 1** Display the VMware version and build number by entering the following commands:
- **vmware -v**
 - **vmware -l**
- Step 2** Log in to the ESXi stateless host.
- Step 3** Copy the offline bundle to the host by entering the the following command:
esxcli software vib install -d file_path/offline_bundle
Note If the host is an ESXi 5.0.0 stateful host, the “Message: Operation finished successfully” line appears.
- Step 4** Verify that the VIB has installed by entering the following command:
esxcli software vib list | grep cisco
- Step 5** Change to Check that the VEM agent is running by entering the following command:
vem status -v
- Step 6** Display the VEM version, VSM version, and ESXi version by entering the following command:
vemcmd show version
- Step 7** Display the ESXi version and details about passthrough NICs by entering the following command:
vem version -v
- Step 8** Add the host to the DVS by using the vCenter Server.
- Step 9** On the VSM, verify that the VEM software has been installed by entering the following command:

show module

This example shows how to install VEM software on a stateless host using esxcli.

**Note**

The examples in the procedure may contain Cisco Nexus 1000V versions and filenames that are not relevant to your release. Refer to the *Cisco Nexus 1000V and VMware Compatibility Information* for your specific versions and filenames.

```

~ # vmware -v
VMware ESXi 5.5.0 build-2068190
~ #
~ # vmware -l
VMware ESXi 5.5.0 Update 2

~ # esxcli software vib install -d
/vmfs/volumes/newnfs/MN-VEM/VEM550-201607300113-BG-release.zip
Installation Result
Message: WARNING: Only live system was updated, the change is not persistent.
Reboot Required: false
VIBs Installed: Cisco_bootbank_cisco-vem-300-esx_5.2.1.3.2.1.0-3.2.1.vib
VIBs Removed:
VIBs Skipped:

~ # esxcli software vib list | grep cisco
cisco-vem-v300-esx          5.2.1.3.2.1.0-3.2.1          Cisco   Par
                           tnerSupported 2016-02-05

vem status -v
Package vssnet-esxesx2013-release
Version 5.2.1.3.2.1.0-3.2.1
Build 1
Date Wed Feb 17 16:27:37 PST 2016

VEM modules are loaded

Switch Name      Num Ports  Used Ports  Configured Ports  MTU  Uplinks
vSwitch0        2432      6           128              1500  vmnic0

DVS Name         Num Ports  Used Ports  Configured Ports  MTU  Uplinks
BL              1024      18          1024             1500  vmnic5,vmnic4,vmnic7

VEM Agent (vemdpa) is running

~ # vemcmd show version
VEM Version: 5.2.1.3.2.1.0-3.2.1
VSM Version: 5.2(1)SV3(2.1)
System Version: VMware ESXi 5.5.0 Releasebuild-2068190
ESX Version Update Level: 2

~ #

~(config)# show module

Mod  Ports  Module-Type                Model                Status
---  ---  -
1    0      Virtual Supervisor Module  Nexus1000V          ha-standby
2    0      Virtual Supervisor Module  Nexus1000V          active *
3    1022   Virtual Ethernet Module    NA                   ok
4    1022   Virtual Ethernet Module    NA                   ok
5    1022   Virtual Ethernet Module    NA                   ok
6    1022   Virtual Ethernet Module    NA                   ok
7    1022   Virtual Ethernet Module    NA                   ok

```

```

Mod  Sw
-----
1    5.2 (1) SV3 (2.1)      0.0
2    5.2 (1) SV3 (2.1)      0.0
3    5.2 (1) SV3 (2.1)      VMware ESXi 5.1.0 Releasebuild-2323236 (3.1)
4    5.2 (1) SV3 (2.1)      VMware ESXi 5.1.0 Releasebuild-2323236 (3.1)
5    5.2 (1) SV3 (2.1)      VMware ESXi 6.0.0 Releasebuild-3620759 (6.0)
6    5.2 (1) SV3 (2.1)      VMware ESXi 5.5.0 Releasebuild-2068190 (3.2)
7    5.2 (1) SV3 (2.1)      VMware ESXi 6.0.0 Releasebuild-3620759 (6.0)

Mod  Server-IP      Server-UUID      Server-Name
-----
1    10.197.133.101  NA               NA
2    10.197.133.101  NA               NA
3    10.197.132.44   7b1a5e63-bcd0-11e0-bd1d-30e4dbc2c3ae  NA
4    10.197.132.42   e0829a21-bc61-11e0-bd1d-30e4dbc2ba66  NA
5    10.197.132.43   e6c1a563-bc9e-11e0-bd1d-30e4dbc2baba  NA
6    10.197.132.46   db8b80ac-af1d-11e0-a4e7-30e4dbc26b82  NA
7    10.197.132.45   8d8ff0e8-b565-11e0-bd1d-30e4dbc297da  NA

* this terminal session

~#

```

Installing the VEM Software on a Stateless ESXi Host Using VUM

Before You Begin

- Make sure that the VUM patch repository has the VEM software downloaded.

Procedure

-
- Step 1** In vCenter Server, choose **Home > Update Manager > Configuration > ESX host/Cluster settings**. The ESX Host/Cluster Settings window opens.

Step 2 Check the **PXE Booted ESXi Host Settings** check box.

Figure 9: ESX Host/Cluster Settings Window

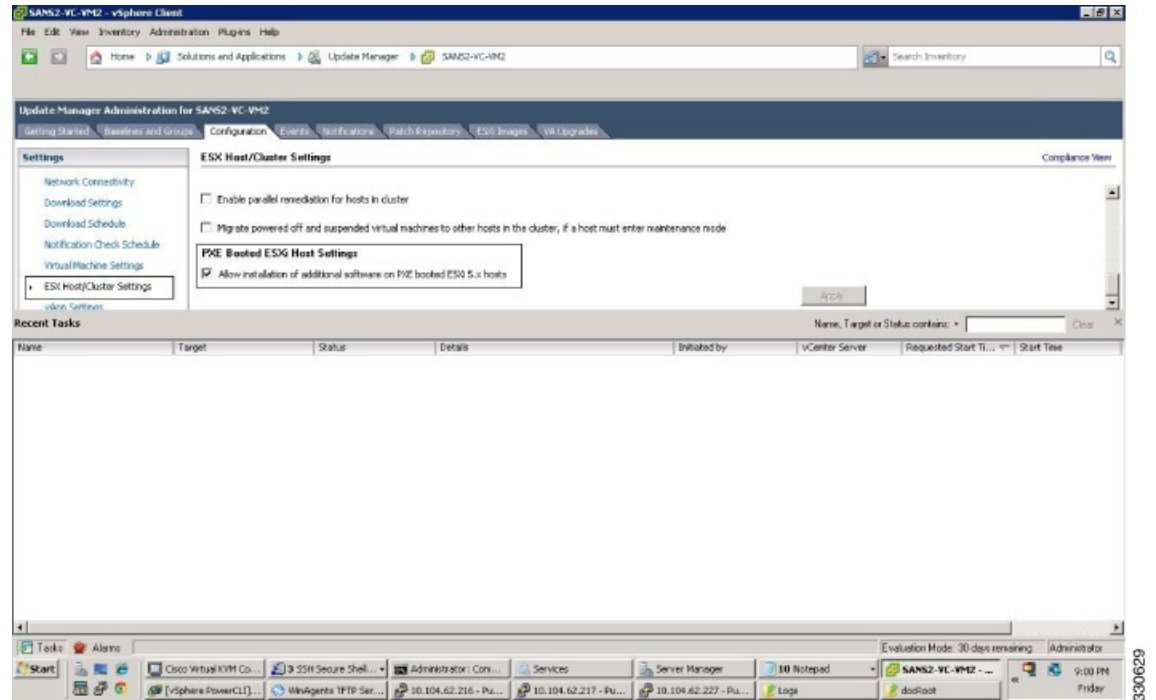

Step 3 Add the host to the DVS by using vCenter Server.

Configuring Layer 2 Connectivity



Note Layer 3 connectivity is the preferred method.

You can configure a different VMware vSwitch port group for each VSM network adapter.

Procedure

Step 1 In the **Configure Networking** screen click **L2: Configure port groups for L2**.

Step 2 In the **Configure Networking** screen, do the following:

- From the **Port Group** drop-down list, choose your port groups.
- (Optional) In the **VLAN ID** field, enter the VLAN ID.

Note The VLAN ID is only needed if you choose to create a new port group.

- Click **Next**. The Configure Networking screen opens.

Figure 10: Configure Networking Screen

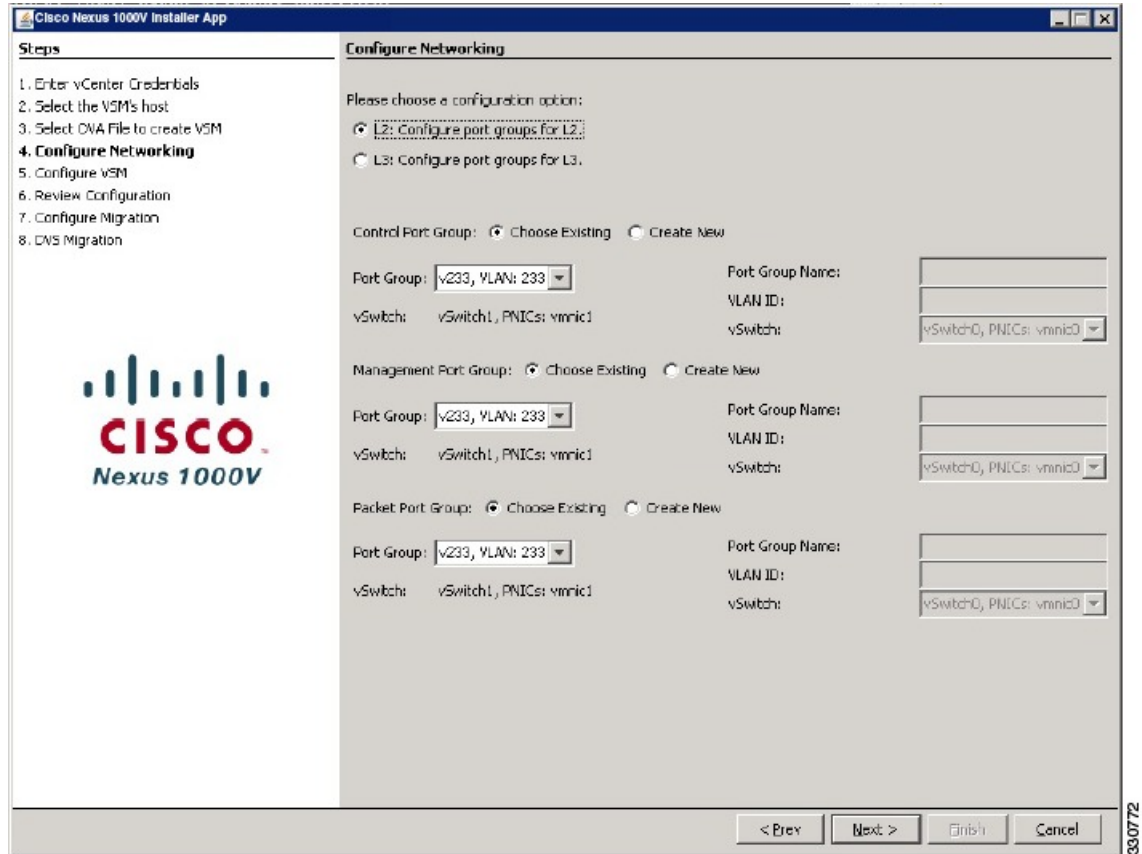

- Step 3** If desired, return to your Standard or Custom installation to enter the remaining Layer 2 configuration information.

Installing a VSM on the Cisco Nexus Cloud Services Platform

You can install the VSM on the Cisco Nexus Cloud Services Platform and move from Layer 2 to Layer 3 connectivity.

**Note**

VEMs do not register to the VSM before a vmkernel interface (vmk) is migrated to a Layer 3 control-capable port profile. You must migrate a vmk to the Layer 3 port profile after migrating host vmnics to Ethernet port profiles.

The example may contain Cisco Nexus 1000V versions and filenames that are not relevant to your release. Refer to the *Cisco Nexus 1000V and VMware Compatibility Information* for your specific versions and filenames.

Before You Begin

Copy the OVA file to the bootflash:repository/ of the Cisco Nexus Cloud Services Platform.

Procedure**Step 1** Create a virtual service blade.

```
switch(config)# show virtual-service-blade summary
```

```
-----
Name           HA-Role      HA-Status    Status          Location
-----
```

```
switch(config)# virtual-service-blade vsm-1
```

```
switch(config-vsbs-config)# virtual-service-blade-type new n1000v-dk9.5.2.1.SV3.2.1.1010.ova
```

```
switch(config-vsbs-config)# show virtual-service-blade summary
```

```
-----
Name           HA-Role      HA-Status    Status          Location
-----
vsm-1         PRIMARY      NONE         VSB NOT PRESENT  PRIMARY
vsm-1         SECONDARY    NONE         VSB NOT PRESENT  SECONDARY
```

```
switch(config-vsbs-config)#
```

Step 2 Configure the control, packet, and management interface VLANs for static and flexible topologies.

```
switch(config-vsbs-config)# interface management vlan 100
```

```
switch(config-vsbs-config)# interface control vlan 101
```

```
switch(config-vsbs-config)# interface packet vlan 101
```

Step 3 Configure the Cisco Nexus 1000V on the Cisco Nexus 1010.

```
switch(config-vsbs-config)# enable
```

```
Enter vsb image: [n1000v-dk9.5.2.1.SV3.2.1.1010.ova]
```

```
Enter domain id[1-1023]: 127
```

```
Enter SVS Control mode (L2 / L3): [L3] L2
```

```
Management IP version [V4/V6]: [V4]
```

```
Enter Management IP address: 192.0.2.79
```

```
Enter Management subnet mask: 255.255.255.0
```

```
IPv4 address of the default gateway: 192.0.2.1
```

```
Enter HostName: n1000v
```

```
Enter the password for 'admin': *****
```

Note: VSB installation is in progress, please use show virtual-service-blade commands to check the installation status.

```
switch(config-vs-b-config)#
```

Step 4 Display the primary and secondary VSM status.

```
switch(config-vs-b-config)# show virtual-service-blade summary
```

```
-----
Name           HA-Role      HA-Status    Status                               Location
-----
vsm-1          PRIMARY     NONE         VSB POWER ON IN PROGRESS           PRIMARY
vsm-1          SECONDARY   ACTIVE       VSB POWERED ON                     SECONDARY
-----
```

Step 5 Log in to the VSM.

```
switch(config)# virtual-service-blade vsm-1
switch(config-vs-b-config)# login virtual-service-blade vsm-1
Telnet escape character is '^\'
Trying 192.0.2.18...
Connected to 192.0.2.18.
Escape character is '^\'

Nexus 1000v Switch
n1000v login: admin
Password:
Cisco Nexus operating System (NX-OS) Software
TAC support: http://www.cisco.com/tac
Copyright (c) 2002-2016, Cisco Systems, Inc. All rights reserved.
The copyrights to certain works contained in this software are
owned by other third parties and used and distributed under
license. Certain components of this software are licensed under
the GNU General Public License (GPL) version 2.0 or the GNU
Lesser General Public License (LGPL) Version 2.1. A copy of each
such license is available at
http://www.opensource.org/licenses/gpl-2.0.php and
http://www.opensource.org/licenses/lgpl-2.1.php
switch#
```

Step 6 Change svcs mode from Layer 2 to Layer 3 in the Cisco Nexus 1000V.

Note The configuration in the highlighted code is optional.

```
switch(config)# svcs-domain
switch(config-svs-domain)# no control vlan
Warning: Config saved but not pushed to vCenter Server due to inactive connection!
switch(config-svs-domain)# no packet vlan
Warning: Config saved but not pushed to vCenter Server due to inactive connection!
switch(config-svs-domain)# svcs mode L3 interface mgmt0
Warning: Config saved but not pushed to vCenter Server due to inactive connection!
switch(config-svs-domain)# show svcs domain
switch(config-svs-domain)# show svcs domain
SVS domain config
Domain id: 101
Control vlan: NA
Packet vlan: NA
L2/L3 Control mode: L3
L3 control interface: mgmt0
```

```
Status: Config push to VC successful.
switch(config-svs-domain)#
```

Feature History for Installing the Cisco Nexus 1000V

The following table lists the release history for installing the Cisco Nexus 1000V.

Feature Name	Releases	Feature Information
VEM Installation 5.1	4.2(1)SV2(2.1)	Installing VEM software remotely or locally on a VMware 5.1 host using the CLI is now supported.
Standard and Custom installation application	4.2(1)SV2(1.1)	Installation Application updated with a Standard and Custom version
Updated installation application	4.2(1)SV1(5.2)	Added screens to the Java application.
VSM and VEM Installation	4.2(1)SV1(5.1)	Java applications introduced for VSM and VEM installation.
Installing the Cisco Nexus 1000V	4.0(1)SV1(1)	Introduced in this release.



Upgrading the Cisco Nexus 1000V

This chapter contains the following sections:

- [Information About the Software Upgrade, page 51](#)
- [Prerequisites for the Upgrade, page 53](#)
- [Prerequisite to Upgrading a VSM to a 3-GB Hard Disk Drive, page 55](#)
- [Guidelines and Limitations for Upgrading the Cisco Nexus 1000V, page 59](#)
- [Upgrade Procedures, page 61](#)
- [Reserving the Memory and CPU on the Virtual Supervisor Module Virtual Machine, page 63](#)
- [Reserving the Memory and CPU for the Virtual Supervisor Module in VSB on the Cloud Services Platform, page 64](#)
- [VSM Upgrade Procedures, page 66](#)
- [VEM Upgrade Procedures, page 70](#)
- [Simplified Upgrade Process, page 89](#)
- [Migrating from Layer 2 to Layer 3, page 91](#)

Information About the Software Upgrade

Mixed Mode Upgrade Support

Starting with Cisco Nexus 1000V, Release 5.2(1)SV3(1.15), Cisco Nexus 1000V deployment supports configuration where the VSM version can be same or higher than the VEM version. With the mixed mode upgrade functionality, you can now upgrade the VSM without upgrading the VEM and reduce the overall overheads involved in Cisco Nexus 1000V upgrade. For example, you can upgrade only the VSM to release 5.2(1)SV3(1.15) from a previous release and skip the VEM upgrade. The following table lists the releases that support mixed mode upgrade.

Table 4: Mixed Mode Support Matrix

Software	Release Number
VMware ESX	5.0, 5.1, 5.5, and 6.0
Cisco Nexus 1000V	5.2(1)SV3(1.4) and later

Upgrade Software Sources

Note

An [interactive upgrade tool](#) has been provided to assist you in determining the correct upgrade steps based on your current environment and the one to which you want to upgrade.

You can obtain your upgrade-related software from the following sources listed in this table:

Table 5: Obtaining the Upgrade Software

Source	Description
Cisco	Download the current release of the Cisco Nexus 1000V software from http://www.cisco.com/en/US/products/ps9902/index.html .
VMware	<p>Download the VMware software from the VMware website.</p> <p>The current Cisco Nexus 1000V software release image for VMware Release 5.1 is at the VMware web site:</p> <ul style="list-style-type: none"> • Online portal for VMware Update Manager (VUM): http://hostupdate.vmware.com/software/VUM/PRODUCTION/cisco-main/esx/cisco/cisco-index.xml • Offline patch portal: http://www.vmware.com/patchmgr/download.portal

For information about your software and platform compatibility, see the *Cisco Nexus 1000V and VMware Compatibility Information* document.

Information about NetFlow Upgrade

With Distributed NetFlow, the switch sends NetFlow export packets directly from the VEMs to the collectors.

During the upgrade process, the switch migrates from the old centralized model to the new distributed model. As part of this migration, unsupported commands are removed and/or converted as part of the VSM upgrade. The new and changed commands are available as soon as all of the VEMs are upgraded and the feature level is updated. Additionally, the following new requirements are imposed on the network reachability:

- The collectors must be Layer 3 reachable from at least one vmknic on each VEM host.
- Strict Reverse Path Forwarding (RPF) might need to be disabled on the routers between the VEM hosts and the collectors.

These are the removed, converted, and new commands:

Command	Change
cache size	Removed. The cache size is no longer user configurable.
timeout active timeout inactive	Converted. The configured timeout active and timeout inactive values are consolidated and converted to be the flow timeout active and flow timeout inactive values. The new consolidated timeouts are set to the maximum of the old individual timeouts. Note After conversion, subsequent changes to the timeouts do not apply to the existing interface configurations on non-upgraded VEMs.
source mgmt	Converted. The configured source mgmt values are converted to be the source lc-exp values. The NetFlow export packets are no longer sent from the VSM's mgmt0 interface.
netflow layer2-switched input	New. The netflow layer2-switched input command configures the Layer 2 default record.
match datalink	New. The match datalink command configures the Layer 2 record fields.

Prerequisites for the Upgrade

Before You Begin

Review the following information before you begin an upgrade:

- Virtual machine hardware version 11 is not supported.
- The Virtual Service Domain (VSD) feature is no longer supported and must be removed before upgrading to Release 5.2(1)SV3(1.4).
- The Upgrade Application cannot be used for the direct upgrade of the Virtual Supervisor Module (VSMs) from Releases 4.2(1)SV1(4), 4.2(1)SV1(5.1), 4.2(1)SV1(5.2), 5.2(1)SV3(1.2), and 5.2(1)SV3(1.3) to the current release.
- A pair of VSMs in a high availability (HA) pair is required in order to support a nondisruptive upgrade.
- A system with a single VSM can only be upgraded in a disruptive manner.
- The network and server administrators must coordinate the upgrade procedure with each other.
- The upgrade process is irrevocable. After the software is upgraded, you can downgrade by removing the current installation and reinstalling the software. For more information, see the “Recreating the Installation” section of the *Cisco Nexus 1000V Troubleshooting Guide*.
- A combined upgrade of ESX and the Virtual Ethernet Module (VEM) in a single maintenance mode is supported in this release. A combined upgrade requires at least vCenter 5.0 Update 1 whether you upgrade manually or are using the VMware Update Manager.
- You can manually upgrade the ESX and VEM in one maintenance mode as follows:
 - 1 Place the host in maintenance mode.
 - 2 Upgrade ESX to 5.0 or 5.1 as needed.
 - 3 Install the VEM vSphere Installation Bundle (VIB) while the host is still in maintenance mode.
 - 4 Remove the host from maintenance mode.
- The steps for the manual combined upgrade procedure do not apply for VMware Update Manager (VUM)-based upgrades.
- You can abort the upgrade procedure by pressing Ctrl-C.

Prerequisites for Upgrading VSMs

Upgrading VSMs has the following prerequisites:

- Close any active configuration sessions before upgrading the Cisco Nexus 1000V software.
- Save all changes in the running configuration to the startup configuration.
- Save a backup copy of the running configuration in external storage.
- Perform a VSM backup. For more information, see the “Configuring VSM Backup and Recovery” chapter in the *Cisco Nexus 1000V System Management Configuration Guide*.
- Use the VSM management IP address to log into VSM and perform management tasks.

**Important**

If you connect to a VSM using the VSA serial port or the connect host from the Cisco Integrated Management Control (CIMC), do not initiate commands that are CPU intensive, such as copying image from the TFTP server to bootflash or generating a lot of screen output or updates. Use the VSA serial connections, including CIMC, only for operations such as debugging or basic configuration of the VSA.

Prerequisite to Upgrading a VSM to a 3-GB Hard Disk Drive

Cisco Nexus 1000V for VMware Release 5.2(1)SV3(1.x) and higher requires a minimum of 3-GB of hard disk drive (HDD) space. If you are upgrading from a previous release to Release 5.2(1)SV3(1.x) and you have a 2-GB HDD, you must upgrade to a 3-GB HDD.

Upgrading Hard Disk Drive Space from 2 GB to 3 GB on a VSM as a VM

We recommend that you upgrade the HDD space from 2 GB to 3 GB on a VSM VM before upgrading VSM to Release 5.2(1)SV3(1.1) or later.

Before You Begin

Make sure that the Cisco Nexus 1000V VSMs are running Release 4.2(1)SV2(1.1) or 4.2(1)SV2(2.1).

Make sure that the existing Cisco Nexus 1000V VSMs are an HA pair with 2 GB HDD.

Procedure

-
- Step 1** Remove the existing standby VSM.
- Right-click the VSM VM and power off the VM.
 - Remove it from the Virtual Center inventory.
- Step 2** Bring up the new standby VSM VM (with 3-GB HDD) with the same release as the active VSM using ISO. For example, if the active VSM is running Release 4.2(1)SV2(1.1), bring up the new standby VSM with Release 4.2(1)SV2(1.1).
- Confirm that the same port profiles are used as the primary VSM for 3 network interfaces.
 - Provision a 3-GB HDD with a minimum of 2 GB of RAM reserved and allocated, and a minimum CPU speed of 1600 MHz.
- For more information, see the *Cisco Nexus 1000V Installation and Upgrade Guide* available at <http://www.cisco.com/c/en/us/support/switches/nexus-1000v-switch-vmware-vsphere/products-installation-guides-list.html> for more information.
- Step 3** Power on the standby VSM.
- Confirm the HA role is set as Secondary.
 - Confirm the Domain ID is the same as the Primary VSM.
- Step 4** After the HA pair is formed, perform a system switchover to make the standby VSM become the active VSM.
- Step 5** Remove the current standby VSM.

- a) Right-click the VSM VM and power off the VM.
 - b) Remove it from the Virtual Center inventory.
- Step 6** Change the Active VSM system redundancy role to the Primary system by entering **system redundancy role primary**.
- Step 7** Copy the config to start up and perform a reload.
- Step 8** Verify the current role by entering **show system redundancy status**. The role should be set as Primary.
- Step 9** Bring up the new standby VSM VM (with 3-GB HDD) using ISO following Step 2 and Step 3.
- Step 10** After the HA pair is formed, verify it by entering **show system internal flash**. It should reflect the VSM with 3-GB HDD.

What to Do Next

Perform an in-service software upgrade (ISSU) to Release 5.2(1)SV3(1.1) or later.

Upgrading Hard Disk Drive Space from 2 GB to 3 GB on a VSM on a VSB

We recommend that you upgrade the VSM that is deployed on a CSP from a 2-GB HDD to a 3-GB HDD.

Procedure

- Step 1** Identify the standby VSM by entering the **show virtual-service-blade summary** command.

```
N1110# show virtual-service-blade summary
```

Name	HA-Role	HA-Status	Status	Location
switch	PRIMARY	ACTIVE	VSB POWERED ON	PRIMARY
switch	SECONDARY	STANDBY	VSB POWERED ON	SECONDARY

```
N1110#
```

The output shows that the standby VSM is running on the secondary Cisco Nexus 1010 Virtual Service Blade (VSB).

- Step 2** Shut down and delete the standby VSM on the secondary VSB.
- a) N1110# **configure terminal**
 - b) N1110#(config)**virtual-service-blade** name switch
 - c) N1110#(config-vs-b-config)**shutdown secondary**
 - d) N1110#(config-vs-b-config)**no enable secondary**
- Step 3** Bring up the new secondary VSB with Release 4.2(1)SV2(1.1) using ISO.
See the [Cisco Nexus 1100 Series Virtual Services Appliances Deployment Guide White Paper](#) for more information.
- Step 4** Change the disk size to 3 GB or more.
N1110 (config-vs-b-config) # **disksize 4**
- Step 5** Enable the standby VSM on the secondary VSB.

See the [Cisco Nexus 1100 Series Virtual Services Appliances Deployment Guide White Paper](#) for more information.

N1110# sh virtual-service-blade summary

```
-----
```

Name	HA-Role	HA-Status	Status	Location
switch	PRIMARY	ACTIVE	VSB POWERED ON	PRIMARY
switch	SECONDARY	NONE	VSB NOT PRESENT	SECONDARY
switch1	PRIMARY	NONE	VSB NOT PRESENT	PRIMARY
switch1	SECONDARY	STANDBY	VSB POWERED ON	SECONDARY

N1110#

Step 6 Perform a system switchover to make the active VSM on the primary VSB become the standby VSM. To do this, enter the **system switchover** command on the active VSM.

N1110# **system switchover**

N1110(config-vsbs-config)# **show virtual-service-blade summary**

```
-----
```

Name	HA-Role	HA-Status	Status	Location
switch	PRIMARY	STANDBY	VSB POWERED ON	PRIMARY
switch	SECONDARY	NONE	VSB NOT PRESENT	SECONDARY
switch1	PRIMARY	NONE	VSB NOT PRESENT	PRIMARY
switch1	SECONDARY	ACTIVE	VSB POWERED ON	SECONDARY

N1110(config-vsbs-config)#

Step 7 After the HA pair is formed, shut down and delete the standby VSM on the primary VSB.

N1110(config)# **virtual-service-blade switch**

N1110(config-vsbs-config)# **shutdown primary**

N1110(config-vsbs-config)# **no enable primary**

N1110(config-vsbs-config)# **show virtual-service-blade summary**

```
-----
```

Name	HA-Role	HA-Status	Status	Location
switch	PRIMARY	NONE	VSB NOT PRESENT	PRIMARY
switch	SECONDARY	NONE	VSB NOT PRESENT	SECONDARY
switch1	PRIMARY	NONE	VSB NOT PRESENT	PRIMARY
switch1	SECONDARY	ACTIVE	VSB POWERED ON	SECONDARY

N1110(config-vsbs-config)#

Step 8 Bring up the new VSB with Release 4.2(2)SV2(1.1) using ISO.

See the [Cisco Nexus 1100 Series Virtual Services Appliances Deployment Guide White Paper](#) for more information.

Step 9 Enable the primary VSM.

See the [Cisco Nexus 1100 Series Virtual Services Appliances Deployment Guide White Paper](#) for more information.

N1110(config)# **show virtual-service-blade summary**

```
-----
```

Name	HA-Role	HA-Status	Status	Location
switch	PRIMARY	NONE	VSB NOT PRESENT	PRIMARY
switch	SECONDARY	NONE	VSB NOT PRESENT	SECONDARY
switch1	PRIMARY	STANDBY	VSB POWERED ON	PRIMARY
switch1	SECONDARY	ACTIVE	VSB POWERED ON	SECONDARY

```
N1110(config-vsbs-config)#
```

Step 10 Verify that the HDD size has changed. The following example shows that the HDD size is 4 GB.

```
N1110(config)# show system internal flash
```

Mount-on	1K-blocks	Used	Available	Use%	Filesystem
/		307200	87628	219572	29 /dev/root
/proc		0	0	0	0 proc
/isan	614400	243076	371324	40	none
/var/sysmgr	512000	18896	493104	4	none
/var/sysmgr/ftp	204800	40	204760	1	none
/dev/shm	358400	30268	328132	9	none
/volatile	20480	0	20480	0	none
/debug	2048	8	2040	1	none
/dev/mqueue	0	0	0	0	none
/mnt/cfg/0	326681	8360	301455	3	/dev/hda5
/mnt/cfg/1	326681	8359	301456	3	/dev/hda6
/var/sysmgr/startup-cfg	409600	1168	408432	1	none
/dev/pts	0	0	0	0	devpts
/mnt/pss	326671	8625	301178	3	/dev/hda3
/bootflash	3122988	151756	2812592	6	/dev/hda4
/bootflash_sup-remote	3122992	151760	2812592	6	

```
127.1.1.1:/mnt/bootflash/
```

What to Do Next

Perform an in-service software upgrade (ISSU) to Release 5.2(1)SV3(1.1) or later.

Verifying that the VSM Has 3 GB of Hard Disk Drive Storage

You can display the system internal flash to verify that have at least 3 GB of HDD space.

Procedure

Step 1 Display the system internal flash.

```
switch# show system internal flash
```

Mount-on	1K-blocks	Used	Available	Use%	Filesystem
/	307200	77808	229392	26	/dev/root
/mnt/pss	248895	8164	227879	4	/dev/sda3
/proc	0	0	0	0	proc
/isan	614400	372236	242164	61	none
/var/sysmgr	1048576	488704	559872	47	none

/var/sysmgr/ftp	204800	52	204748	1	none
/nxos/tmp	20480	0	20480	0	none
/dev/shm	358400	89660	268740	26	none
/volatile	20480	0	20480	0	none
/debug	2048	128	1920	7	none
/dev/mqueue	0	0	0	0	none
/mnt/cfg/0	248895	4494	231551	2	/dev/sda5
/mnt/cfg/1	241116	4493	224175	2	/dev/sda6
/var/sysmgr/startup-cfg	409600	5892	403708	2	none
/dev/pts	0	0	0	0	devpts
/mnt/pss	248895	8164	227879	4	/dev/sda3
/bootflash	2332296	1918624	295196	87	/dev/sda4
/sys	0	0	0	0	sysfs

Note 1 GB of hard disk space is equal to 1073741.824 1K-blocks.

Step 2 Make sure that the sum total of the number of blocks allocated to the /mnt/cfg/0, /mnt/cfg/1, /mnt/pss, and /bootflash partitions is approximately 3 GB.

Guidelines and Limitations for Upgrading the Cisco Nexus 1000V

Before attempting to migrate to any software image version, follow these guidelines:



Caution

During the upgrade process, the Cisco Nexus 1000V does not support any new additions such as modules, virtual NICs (vNICs), or VM NICs and does not support any configuration changes. VM NIC and vNIC port-profile changes might render VM NICs and vNICs in an unusable state.



Note

We recommended that you use vSphere 5.0 Update 1 or later instead of vSphere 5.0.

- You are upgrading the Cisco Nexus 1000V software to the current release.
- Scheduling—Schedule the upgrade when your network is stable and steady. Ensure that everyone who has access to the switch or the network is not configuring the switch or the network during this time. You cannot configure a switch during an upgrade.
- Hardware—Avoid power interruptions to the hosts that run the VSM VMs during any installation procedure.
- Connectivity to remote servers — do the following:
 - Copy the kickstart and system images from the remote server to the Cisco Nexus 1000V.
 - Ensure that the switch has a route to the remote server. The switch and the remote server must be in the same subnetwork if you do not have a router to route traffic between subnets.
- Software images— Do the following:
 - Make sure that the system and kickstart images are the same version.

- Retrieve the images in one of two ways:
 - Locally—Images are locally available on the upgrade CD-ROM/ISO image.
 - Remotely—Images are in a remote location and you specify the destination using the remote server parameters and the filename to be used locally.
- Commands to use—Do the following:
 - Verify connectivity to the remote server by using the **ping** command.
 - If you are using Layer 3 mode for VSM-to-VEM connectivity, verify the IP address on the Layer 3 control interface using the **show interface {control0 | mgmt0}** command. If the IP address is missing, re-apply the IP address configuration on the corresponding Layer 3 control interface.
 - Use the **install all** command to upgrade your software. This command upgrades the VSMs.
 - Do not enter another **install all** command while running the installation. You can run commands other than configuration commands.
 - During the VSM upgrade, if you try to add a new VEM or any of the VEMs are detached due to uplink flaps, the VEM attachment is queued until the upgrade completes.
 - If VEMs get removed after the VSM upgrade, use the **system switchover** command to perform a system switchover after the HA pair is established.

**Note**

If the ESX hosts are not compatible with the software image that you install on the VSM, a traffic disruption occurs in those modules, depending on your configuration. The **install all** command output identifies these scenarios. The hosts must be at the right version before the upgrade.

Before upgrading the VEMs, note these guidelines and limitations.

**Note**

It is your responsibility to monitor and install all the relevant patches on VMware ESX hosts.

- The VEM software can be upgraded manually using the CLI or upgraded automatically using VUM.
- During the VEM upgrade process, VEMs reattach to the VSM.
- Connectivity to the VSM can be lost during a VEM upgrade when the interfaces of a VSM VM connect to its own Distributed Virtual Switch (DVS).
- If you are upgrading a VEM using a Cisco Nexus 1000V bundle, follow the instructions in your VMware documentation. For more details about VMware bundled software, see the *Cisco Nexus 1000V and VMware Compatibility Information* document.

**Caution**

Do not enter the **vemlog**, **vemcmd**, or **vempkt** commands during the VEM upgrade process because these commands impact the upgrade.



Note

For ESXi 5.1 update 2 and later, the minimum versions are as follows:

- VMware vCenter Server 5.1, 799731
- VMware Update Manager 5.1, 782803

For ESXi 5.5 update 1 and later, the minimum versions are as follows:

- VMware vCenter Server 5.0.0, 455964
- VMware Update Manager 5.0.0 432001

If you plan to do a combined upgrade of ESX and VEM, the minimum vCenter Server/VUM version required is 623373/639867.

This procedure is different from the upgrade to Release 4.2(1)SV1(4). In this procedure, you upgrade the VSMs first by using the **install all** command and then you upgrade the VEMs.

- You can upgrade the hosts in the DVS a few at a time across multiple maintenance windows. The only exception is if you are upgrading the VEM alone using VUM with the ESX version unchanged.

Upgrade Procedures

The following table lists the upgrade steps.



Note

Ensure that you have changed the VSM mode to advanced, before upgrading VSM. VSG services are not available in the essential mode.

Table 6: Upgrade Paths from Cisco Nexus 1000V Releases

If you are running this configuration	Follow these steps
Release 4.0(4)SV1(1), 4.0(4)SV1(2), 4.2(1)SV1(4), 4.2(1)SV1(5.1), and 4.2(1)SV1(5.2)	Direct upgrades from these releases are not supported.
Releases 4.0(4)SV1(3x) Series	<ol style="list-style-type: none"> 1 Upgrading from Releases 4.0(4)SV1(3,3a,3b,3c,3d) to release 4.2(1)SV2(1.1) or later at the following URL: http://www.cisco.com/c/en/us/td/docs/switches/datacenter/nexus1000/sw/4_2_1_s_v_1_4_b/upgrade/software/guide/n1000v_upgrade_software.html#wp465259 2 Upgrade from Releases 4.2(1)SV2(1.1) and later releases to the current release.

If you are running this configuration	Follow these steps
Release 4.2(1)SV1(4x) Series with a vSphere release 4.0 Update 1 or later	<ol style="list-style-type: none"> 1 Upgrading from VMware Release 4.0 to VMware Release 5.0 or later. 2 Upgrading VSMS from releases 4.2(1)SV1(4x) to 4.2(1)SV2(1.1) or later. 3 Upgrading VEMs from releases 4.2(1)SV1(4x) to 4.2(1)SV2(1.1) or later. 4 Upgrading VSMS from releases 4.2(1)SV2(1.1) or later to current release. 5 Upgrading VEMs from releases 4.2(1)SV2(1.1) or later to current release.
Release 4.2(1)SV1(4x) Series with a vSphere release 4.1 GA, patches, or updates	<ol style="list-style-type: none"> 1 Upgrading from VMware Release 4.1 to VMware Release 5.0 or later. 2 Upgrading VSMS from releases 4.2(1)SV1(4x) to 4.2(1)SV2(1.1) or later. 3 Upgrading VEMs from releases 4.2(1)SV1(4x) to 4.2(1)SV2(1.1) or later. 4 Upgrading VSMS from releases 4.2(1)SV2(1.1) or later to current release. 5 Upgrading VEMs from releases 4.2(1)SV2(1.1) or later to current release.
Release 4.2(1)SV1(4x) with a vSphere release 5.0 GA, patches, or updates.	<ol style="list-style-type: none"> 1 Upgrading VSMS from releases 4.2(1)SV1(4x) to 4.2(1)SV2(1.1) or later. 2 Upgrading VEMs from releases 4.2(1)SV1(4x) to 4.2(1)SV2(1.1) or later. 3 Upgrading VSMS from releases 4.2(1)SV2(1.1) or later to current release. 4 Upgrading VEMs from releases 4.2(1)SV2(1.1) or later to current release.

The following table lists the upgrade steps when upgrading from Release 4.2(1)SV1(5x) and later releases to the current release.

Table 7: Upgrade Paths from Releases 4.2(1)SV1(5x) and Later Releases

If you are running this configuration	Follow these steps
With vSphere 4.1 GA, patches, or updates.	<ol style="list-style-type: none"> 1 Upgrading from VMware Release 4.1 to VMware Release 5.0 or later. 2 Upgrading VSMs from releases 4.2(1)SV1(5.1x) to 4.2(1)SV2(1.1) or later. 3 Upgrading VEMs from releases 4.2(1)SV1(5.1x) to 4.2(1)SV2(1.1) or later. 4 Upgrading VSMs from releases 4.2(1)SV2(1.1) or later to current release. 5 Upgrading VEMs from releases 4.2(1)SV2(1.1) or later to current release.
With vSphere 5.0 GA, patches, or updates.	<ol style="list-style-type: none"> 1 Upgrading VSMs from releases 4.2(1)SV1(5.1x) to 4.2(1)SV2(1.1) or later. 2 Upgrading VEMs from releases 4.2(1)SV1(5.1x) to 4.2(1)SV2(1.1) or later. 3 Upgrading VSMs from releases 4.2(1)SV2(1.1) or later to current release. 4 Upgrading VEMs from releases 4.2(1)SV2(1.1) or later to current release.
With ESX version upgrade.	Installing and Upgrading VMware

Reserving the Memory and CPU on the Virtual Supervisor Module Virtual Machine

From the current release of Cisco Nexus 1000V software, the VSM requires 4-GB RAM and two 2048-MHz vCPUs reservation to accommodate the new scalability limits.



Note

When you install the Cisco Nexus 1000V software VSM through the OVA files for the first time, the RAM and CPU reservations are automatically reflected.

To upgrade to the current release of Cisco Nexus 1000V software and update the CPU and RAM reservations, use the following procedure:

Procedure

-
- Step 1** Upgrade from the previous release of Cisco Nexus 1000V software to the current release of Cisco Nexus 1000V software.
- Step 2** Once the upgrade is complete, power off the secondary VSM.
- Step 3** Change the RAM size from 2 or 3 GB to 4 GB and change the RAM reservation from 2 or 3 GB to 4 GB.
- Step 4** Under CPU settings, change the number of vCPUs to 2 and change the CPU reservation from 1.5 GHz to 2048 MHz.
- Step 5** Power on the secondary VSM.
- Step 6** Perform a system switch over to get the secondary VSM as Active.
- Step 7** Power off the primary VSM and repeat steps 3 to 6.
- Step 8** After the primary and secondary VSM have the correct CPU and RAM reservations, the VSM is able to accommodate the scale numbers that are supported on Release 5.2(1)SV3(1.1) or later.
- Note** You do not have to change the CPU and RAM reservations to continue to support for the scale numbers supported in releases prior to Release 5.2(1)SV3(1.1).
-

Reserving the Memory and CPU for the Virtual Supervisor Module in VSB on the Cloud Services Platform

To change the memory reservations in the VSM VSB, use the following procedure:

Before You Begin

From the current release of Cisco Nexus 1000V software, the VSM requires 4-GB RAM and two vCPUs to accommodate the new scalability limits.

Procedure

-
- Step 1** Login to the Cloud Services Platform command prompt.
- Step 2** Enter the VSM configuration mode.
- Step 3** Change the RAM size to 4 GB and change the vCPU number to 2.
- Note** With Cisco Nexus Cloud Services Platform Release 4.2(1)SP1(6.1) and later, the virtual service blades can remain powered on when you change the RAM size. In Cisco Nexus Cloud Services Platform releases earlier than 4.2(1)SP1(6.1), the primary/secondary virtual service blades must be powered off before you can change the RAM size.
- Step 4** Copy the running configuration to the startup configuration.
- Step 5** Reboot the secondary VSM VSB by using the **shut** and **no shut** commands.
- Step 6** Check if the secondary VSM has 4-GB RAM and two vCPUs.
- Step 7** Perform a system switch over from the primary VSM to make the secondary VSM as active with 4-GB RAM and two vCPUs.

The primary VSM reboots and is in the standby state with 4-GB RAM and two vCPUs.

Reserving the Memory and CPU for the Virtual Supervisor Module in VSB on the Cloud Services Platform Using the CLI

To change the memory reservations in the VSM VSB using the CLI, use the following procedure:

Before You Begin

From the current release of Cisco Nexus 1000V software, VSM requires 4 GB RAM to accommodate the new scalability limits.

Procedure

	Command or Action	Purpose
Step 1	CSP configure terminal	Enters the global configuration mode.
Step 2	CSP(config)# virtual-service-blade VSM for the current release	Enters the VSM configuration mode.
Step 3	CSP(config-vs-b-config)# ramsize 4096	Change the RAM size to 4 GB. Note The virtual service blade is powered ON. Restart the VSB to reflect the change in RAM size. Perform a shutdown using the shutdown and no shutdown commands.
Step 4	CSP(config-vs-b-config)# numcpu 2	Changing the number of CPUs to 2.
Step 5	CSP(config-vs-b-config)# copy running-config startup-config	Copies the running configuration to the startup configuration.
Step 6	CSP(config-vs-b-config)# shutdown secondary	Shuts down the secondary VSB.
Step 7	CSP(config-vs-b-config)# no shutdown secondary	Applies the RAM and vCPU changes.
Step 8	VSM# system switchover	Performs a system switch over from primary VSM to make the secondary VSM as active with 4 GB RAM and two vCPUs.
Step 9	VSM(standby)# show system resources	Displays that the secondary VSM has 4 GB of RAM and two vCPUs.

VSM Upgrade Procedures

Software Images

The software image install procedure is dependent on the following factors:

- Software images—The kickstart and system image files reside in directories or folders that you can access from the Cisco Nexus 1000V software prompt.
- Image version—Each image file has a version.
- Disk—The bootflash: resides on the VSM.
- ISO file—If a local ISO file is passed to the **install all** command, the kickstart and system images are extracted from the ISO file.

In-Service Software Upgrades on Systems with Dual VSMs

**Note**

Performing an In-service Upgrade (ISSU) from Cisco Nexus 1000V Release 4.2(1)SV1(4x), 4.2(1)SV1(5.1x), 4.2(1)SV1(5.2x) to the current release of Cisco Nexus 1000V is not supported.

The Cisco Nexus 1000V software supports in-service software upgrades (ISSUs) for systems with dual VSMs. An ISSU can update the software images on your switch without disrupting data traffic. Only control traffic is disrupted. If an ISSU causes a disruption of data traffic, the Cisco Nexus 1000V software warns you before proceeding so that you can stop the upgrade and reschedule it to a time that minimizes the impact on your network.

**Note**

On systems with dual VSMs, you should have access to the console of both VSMs to maintain connectivity when the switchover occurs during upgrades. If you are performing the upgrade over Secure Shell (SSH) or Telnet, the connection will drop when the system switchover occurs, and you must reestablish the connection.

An ISSU updates the following images:

- Kickstart image
- System image
- VEM images

All of the following processes are initiated automatically by the upgrade process after the network administrator enters the **install all** command.

ISSU Process for the Cisco Nexus 1000V

The following figure shows the ISSU process.

Figure 11: ISSU Process

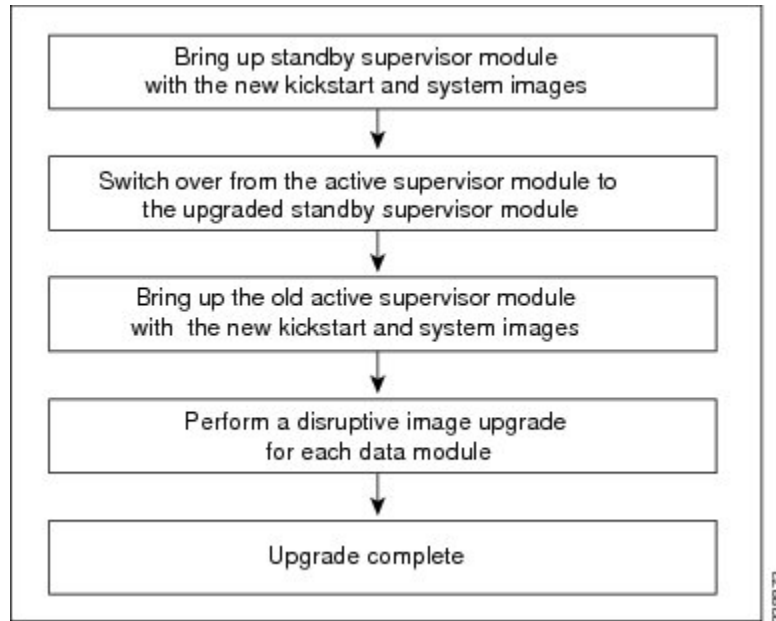

ISSU VSM Switchover

The following figure provides an example of the VSM status before and after an ISSU switchover.

Figure 12: Example of an ISSU VSM Switchover

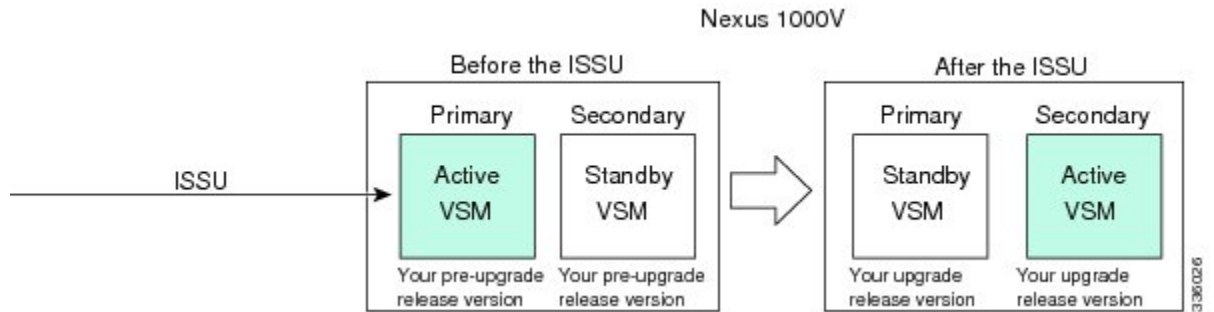

ISSU Command Attributes

Support

The **install all** command supports an in-service software upgrade (ISSU) on dual VSMs in an HA environment and performs the following actions:

- Determines whether the upgrade is disruptive and asks if you want to continue.
- Copies the kickstart and system images to the standby VSM. Alternatively, if a local ISO file is passed to the **install all** command instead, the kickstart and system images are extracted from the file.
- Sets the kickstart and system boot variables.
- Reloads the standby VSM with the new Cisco Nexus 1000V software.
- Causes the active VSM to reload when the switchover occurs.

Benefits

The **install all** command provides the following benefits:

- You can upgrade the VSM by using the **install all** command.
- You can receive descriptive information on the intended changes to your system before you continue with the installation.
- You have the option to cancel the command. Once the effects of the command are presented, you can continue or cancel when you see this question (the default is no):

```
Do you want to continue (y/n) [n]: y
```
- You can upgrade the VSM using the least disruptive procedure.
- You can see the progress of this command on the console, Telnet, and SSH screens:
 - After a switchover process, you can see the progress from both the VSMs.
 - Before a switchover process, you can see the progress only from the active VSM.
- The **install all** command automatically checks the image integrity, which includes the running kickstart and system images.
- The **install all** command performs a platform validity check to verify that a wrong image is not used.
- The Ctrl-C escape sequence gracefully ends the **install all** command. The command sequence completes the update step in progress and returns to the switch prompt. (Other upgrade steps cannot be ended by using Ctrl-C.)
- After running the **install all** command, if any step in the sequence fails, the command completes the step in progress and ends.

Upgrading VSMs from Releases 4.2(1)SV2(1.1) and Later Releases to Release 5.2(1)SV3(1.2) and Later Release

Procedure

- Step 1** Log in to the active VSM.
- Step 2** Log in to Cisco.com to access the links provided in this document. To log in to Cisco.com, go to the URL <http://www.cisco.com/> and click **Log In** at the top of the page. Enter your Cisco username and password.
- Note** Unregistered Cisco.com users cannot access the links provided in this document.
- Step 3** Access the Software Download Center by using this URL:
<http://www.cisco.com/public/sw-center/index.shtml>
- Step 4** Navigate to the download site for your system.
You see links to the download images for your switch.
- Step 5** Choose and download the Cisco Nexus 1000V zip file and extract the kickstart and system software files to a server.
- Step 6** Ensure that the required space is available for the image file(s) to be copied by entering the **dir bootflash:** command.
- Tip** We recommend that you have the kickstart and system image files for at least one previous release of the Cisco Nexus 1000V software on the system to use if the new image files do not load successfully.
- Step 7** Verify that there is space available on the standby VSM by entering the **dir bootflash://sup-standby/** command .
- Step 8** Delete any unnecessary files to make space available if you need more space on the standby VSM.
- Step 9** If you plan to install the images from the bootflash:, copy the Cisco Nexus 1000V kickstart and system images or the ISO image to the active VSM by using a transfer protocol. You can use ftp:, tftp:, scp:, or sftp:. The examples in this procedure copies a kickstart and system image using scp:
- Note** When you download an image file, change to your FTP environment IP address or DNS name and the path where the files are located.
- a) switch# **copy scp://filepath/kickstart_filename bootflash:kickstart_filename**
Copy the ISO image.
- b) switch# **copy scp://filepath/system_filename bootflash:system_filename**
Copy kickstart and system images.
- Step 10** switch# **show install all impact kickstart bootflash:kickstart_filename system bootflash:system_filename**
Verify the ISSU upgrade for the kickstart and system images or the ISO image. The example in this procedure shows the kickstart and system images.
- Step 11** Read the release notes for the related image file. See the *Cisco Nexus 1000V Release Notes*.
- Step 12** Determine if the Cisco Virtual Security Gateway (Cisco VSG) is configured in the deployment by using the **show vnm-pa status** command .
- Note** If an output displaying a successful installation is displayed as in the example, the Cisco VSG is configured in the deployment. You must follow the upgrade procedure in the *Cisco Virtual Security Gateway and Cisco Virtual Network Management Center Installation and Upgrade Guide*. If an output displaying that the policy agent has not installed is displayed, continue to Step 13.

- Step 13** Save the running configuration to the startup configuration by using the **copy running-config startup-config** command.
- Step 14** Save the running configuration on the bootflash and externally.
- Note** You can also run a VSM backup. See the “Configuring VSM Backup and Recovery” chapter of the *Cisco Nexus 1000V System Management Configuration Guide*.
- Save the running configuration on the bootflash by using the **copy running-config bootflash:run-cfg-backup** command.
 - Save the running configuration externally by using the **copy running-config scp://external_backup_location** command.
- Step 15** Perform the upgrade on the active VSM using the ISO or kickstart and system images by using the **install all kickstart bootflash:kickstart_filename system bootflash:system_filename** command. The example in this procedure shows the kickstart and system images.
- Step 16** Continue with the installation by pressing Y.
If you press N, the installation exits gracefully.
- Note** As part of the upgrade process, the standby VSM is reloaded with new images. Once it becomes the HA standby again, the upgrade process initiates a switchover. The upgrade then continues from the new active VSM.
- Step 17** After the installation operation completes, log in and verify that the switch is running the required software version by using the switch# **show version** command
- Step 18** Copy the running configuration to the startup configuration to adjust the startup-config size by using the switch# **copy running-config startup-config** command
- Step 19** Display the log for the last installation by entering the following commands.
- switch# **show install all status**
 - switch# **attach module_name**
 - switch# **show install all status**
- Step 20** Review information about reserving memory and CPU on the VSM VM at the following URL: [Reserving the Memory and CPU on the Virtual Supervisor Module Virtual Machine](#).
- Note** You must review this information, to accommodate the new scalability limits.
-

VEM Upgrade Procedures

Prerequisites for Upgrading VEMs



Caution

If VMware vCenter Server is hosted on the same ESX/ESXi host as a Cisco Nexus 1000V VEM, a VUM-assisted upgrade on the host fails. You should manually VMotion the vCenter Server VM to another host before you perform an upgrade.

**Note**

When you perform any VUM operation on hosts that are a part of a cluster, ensure that VMware HA, VMware fault tolerance (FT), and VMware Distributed Power Management (DPM) features are disabled for the entire cluster. Otherwise, VUM will fail to install the hosts in the cluster.

- If you have VXLAN Gateway installed in your deployment, we recommend that you upgrade the VXLAN gateway service module after upgrading the VSM and *before* upgrading the VEM. This recommendation applies to upgrades to Release 5.2(1)SV3(1.1) and later only.
- You are logged in to the VSM command-line interface (CLI) in EXEC mode.
- You have a copy of your VMware documentation available for installing software on a host.
- You have already obtained a copy of the VEM software file. For more information, see the *Cisco Nexus 1000V and VMware Compatibility Information* document.
- If you need to migrate a vSphere host from ESX to ESXi, do it before the Cisco Nexus 1000V upgrade.
- You have placed the VEM software file in `/tmp` on the vSphere host. Placing it in the root (`/`) directory might interfere with the upgrade. Make sure that the root RAM disk has at least 12 MB of free space by entering the `vdf` command.
- On your upstream switches, you must have the following configuration.
 - On Catalyst 6500 Series switches with the Cisco IOS software, enter the **portfast trunk** command or the **portfast edge trunk** command.
 - On Cisco Nexus 5000 Series switches with the Cisco NX-OS software, enter the **spanning-tree port type edge trunk** command.
- On your upstream switches, we highly recommend that you globally enable the following:
 - Global BPDU Filtering
 - Global BPDU Guard
- On your upstream switches where you cannot globally enable BPDU Filtering and BPDU Guard, we highly recommend that you enter the following commands:
 - **spanning-tree bpdn filter**
 - **spanning-tree bpdn guard**
- The collectors must be L3 reachable from at least one vmknic on each VEM host.
- Strict Reverse Path Forwarding (RPF) may require disabling on the routers between the VEMs and the collectors.
- For more information about configuring spanning tree, BPDU, or PortFast, see the documentation for your upstream switch.

Upgrading Using a Customized ISO with a VMware ESX Image and a Cisco Nexus 1000V VEM Image

Before You Begin

- Install the VMware PowerCLI on a Windows platform. For more information, see the *VMware vSphere PowerCLI Installation Guide*.
- On the same Windows platform, where the VMware PowerCLI is installed, do one of the following:
 - Download the ESX depot, which is a .zip file, to a local file path.
 - Download the VEM offline bundle, which is a .zip file, to a local file path.

Procedure

-
- Step 1** Start the VMWare PowerCLI application.
- Step 2** Connect to the vCenter Server by using the **Connect-VIServer** *IP_address -User Administrator -Password password_name* command.
- Step 3** Load the ESX depot by using the **Add-ESXSoftwareDepot** *path_name\file_name* command.
- Step 4** Display the image profiles by using the **Get-ESXImageProfile** command.
- Step 5** Clone the ESX standard image profile by using the **New-ESXImageProfile -CloneProfile** *ESXImageProfile_name -Name clone_profile* command.
- Note** The image profiles are usually in READ-ONLY format. You must clone the image profile before adding the VEM image to it.
- Step 6** Load the Cisco Nexus 1000V VEM offline bundle by using the **Add-EsxSoftwareDepot** *VEM_offline_bundle* command.
- Step 7** Confirm that the n1kv-vib package is loaded by using the **Get-EsxSoftwarePackage -Name package_name** command.
- Step 8** Bundle the n1kv-package into the cloned image profile by using the **Add-EsxSoftwarePackage -ImageProfile** *n1kv-Image -SoftwarePackage cloned_image_profile* command.
- Step 9** Verify that the Cisco VIB is present by listing all the VIBs in the cloned image profile by entering the following commands.
- \$img = Get-EsxImageProfile n1kv-Image**
 - \$img.vibList**
- Verify that the Cisco VIB is present by listing all the VIBs in the cloned image profile.
- Step 10** Export the image profile to an ISO file by using the **Export-EsxImageProfile -ImageProfile** *n1kv-Image -FilePath iso_filepath* command.
-

This example shows how to create an upgrade ISO with a VMware ESX image and a Cisco VEM image.



Note

The example may contain Cisco Nexus 1000V versions and filenames that are not relevant to your release. Refer to the *Cisco Nexus 1000V and VMware Compatibility Information* for your specific versions and filenames.

```
vSphere PowerCLI> Connect-VIServer 10.105.231.40 -User administrator -Password 'XXXXXXXX'
```

Working with multiple default servers?

Select [Y] if you want to work with more than one default servers. In this case, every time when you connect to a different server using Connect-VIServer, the new server connection is stored in an array variable together with the previously connected servers. When you run a cmdlet and the target servers cannot be determined from the specified parameters, the cmdlet runs against all servers stored in the array variable.

Select [N] if you want to work with a single default server. In this case, when you run a cmdlet and the target servers cannot be determined from the specified parameters, the cmdlet runs against the last connected server.

WARNING: WORKING WITH MULTIPLE DEFAULT SERVERS WILL BE ENABLED BY DEFAULT IN A FUTURE RELEASE. You can explicitly set your own preference at any time by using the DefaultServerMode parameter of Set-PowerCLIConfiguration.

[Y] Yes [N] No [S] Suspend [?] Help (default is "Y"): Y

Name	Port	User
10.105.231.40	443	administrator

```
vSphere PowerCLI> Add-EsxSoftwareDepot 'C:\Documents and Settings\Administrator\Desktop\upgrade\229\VMware-ESXi-5.1.0-20121204001-no-tools-standart\VMEM510-201607300107-BG-release.zip'
```

```
Depot Url
-----
zip:C:\Documents and Settings\Administrator\Desktop\upgrade\229\VMware-ESXi-5.1.0-20121204001-no-tools-standart\VMEM510-201607300107-BG-release.zip
```

```
vSphere PowerCLI> Get-EsxImageProfile
```

Name	Vendor	Last Modified	Acceptance Level
ESXi-5.1.0-201508198107s-no-... CN1-CY	VMware, Inc.	08/12/2015 7:...	PartnerSupported
ESXi-5.1.0-20121204001-stan...	CISCO	4/22/2013 11:...	PartnerSupported
ESXi-5.1.0-20121204001-sta...	VMware, Inc.	12/7/2012 7:...	PartnerSupported
ESXi-5.1.0-20121201001s-sta...	VMware, Inc.	12/7/2012 7:...	PartnerSupported
ESXi-5.1.0-799733-no-tools	VMware, Inc.	8/2/2012 3:0...	PartnerSupported
ESXi-5.1.0-20121204001-no-t...	VMware, Inc.	12/7/2012 7:...	PartnerSupported
ESXi-5.1.0-799733-standard	VMware, Inc.	8/2/2012 3:0...	PartnerSupported

```
vSphere PowerCLI> New-EsxImageProfile -CloneProfile ESXi-5.1.0-799733-standard -Name FINAL
```

cmdlet New-EsxImageProfile at command pipeline position 1
 Supply values for the following parameters:
 (Type !? for Help.)
 Vendor: CISCO

Name	Vendor	Last Modified	Acceptance Level
FINAL	CISCO	02/02/2016 3:0...	PartnerSupported

```
vSphere PowerCLI> Add-EsxSoftwareDepot 'C:\Documents and Settings\Administrator\Desktop\upgrade\229\VMEM550-201607300113-BG-release.zip'
```

```
Depot Url
-----
zip:C:\Documents and Settings\Administrator\Desktop\upgrade\229\cisco-vem-v1.0-201607300113-BG-release.zip
```

```
vSphere PowerCLI> Get-EsxSoftwarePackage cisco*
```

Name	Version	Vendor	Creation Date
-----	-----	-----	-----
cisco-vem-v300-esx	5.2.1.3.2.1.0-3.2.1	Cisco Partner Supported	2016-02-02

```
vSphere PowerCLI> Add-ExsSoftwarePackage -SoftwarePackage cisco-vem-v198-esx -ImageProfile FINAL
```

Name	Vendor	Last Modified	Acceptance Level
-----	-----	-----	-----
FINAL	CISCO	07/02/2016 3:...	PartnerSupported

```
vSphere PowerCLI> $img = Get-ExsImageProfile FINAL
```

```
vSphere PowerCLI> $img.vibList
```

Name	Version	Vendor	Creation Date
-----	-----	-----	-----
scsi-bnx2i	1.9.1d.v50.1-5vmw.510.0.0.7...	VMware	8/2/2012 ...
sata-sata-promise	2.12-3vmw.510.0.0.799733	VMware	8/2/2012 ...
net-forcedeth	0.61-2vmw.510.0.0.799733	VMware	8/2/2012 ...
esx-xserver	5.1.0-0.0.799733	VMware	8/2/2012 ...
misc-cnic-register	1.1-1vmw.510.0.0.799733	VMware	8/2/2012 ...
net-tg3	3.110h.v50.4-4vmw.510.0.0.7...	VMware	8/2/2012 ...
scsi-megaraid-sas	5.34-4vmw.510.0.0.799733	VMware	8/2/2012 ...
scsi-megaraid-mbox	2.20.5.1-6vmw.510.0.0.799733	VMware	8/2/2012 ...
scsi-ips	7.12.05-4vmw.510.0.0.799733	VMware	8/2/2012 ...
net-e1000e	1.1.2-3vmw.510.0.0.799733	VMware	8/2/2012 ...
sata-ahci	3.0-13vmw.510.0.0.799733	VMware	8/2/2012 ...
sata-sata-svw	2.3-3vmw.510.0.0.799733	VMware	8/2/2012 ...
net-cnic	1.10.2j.v50.7-3vmw.510.0.0....	VMware	8/2/2012 ...
net-e1000	8.0.3.1-2vmw.510.0.0.799733	VMware	8/2/2012 ...
ata-pata-serverworks	0.4.3-3vmw.510.0.0.799733	VMware	8/2/2012 ...
scsi-mptspi	4.23.01.00-6vmw.510.0.0.799733	VMware	8/2/2012 ...
ata-pata-hpt3x2n	0.3.4-3vmw.510.0.0.799733	VMware	8/2/2012 ...
net-s2io	2.1.4.13427-3vmw.510.0.0.79...	VMware	8/2/2012 ...
esx-base	5.1.0-0.0.799733	VMware	8/2/2012 ...
net-vmxnet3	1.1.3.0-3vmw.510.0.0.799733	VMware	8/2/2012 ...
net-bnx2	2.0.15g.v50.11-7vmw.510.0.0...	VMware	8/2/2012 ...
cisco-vem-v260-esx	5.2.1.3.1.15.0-3.1.2	Cisco	2014-11-10
scsi-megaraid2	2.00.4-9vmw.510.0.0.799733	VMware	8/2/2012 ...
ata-pata-amd	0.3.10-3vmw.510.0.0.799733	VMware	8/2/2012 ...
ipmi-ipmi-si-drv	39.1-4vmw.510.0.0.799733	VMware	8/2/2012 ...
scsi-lpfc820	8.2.3.1-127vmw.510.0.0.799733	VMware	8/2/2012 ...
ata-pata-atiixp	0.4.6-4vmw.510.0.0.799733	VMware	8/2/2012 ...
esx-dvfilter-generic-...	5.1.0-0.0.799733	VMware	8/2/2012 ...
net-sky2	1.20-2vmw.510.0.0.799733	VMware	8/2/2012 ...
scsi-qla2xxx	902.kl.1-9vmw.510.0.0.799733	VMware	8/2/2012 ...
net-r8169	6.011.00-2vmw.510.0.0.799733	VMware	8/2/2012 ...
sata-sata-sil	2.3-4vmw.510.0.0.799733	VMware	8/2/2012 ...
scsi-mpt2sas	10.00.00.00-5vmw.510.0.0.79...	VMware	8/2/2012 ...
sata-ata-piix	2.12-6vmw.510.0.0.799733	VMware	8/2/2012 ...
scsi-hpsa	5.0.0-21vmw.510.0.0.799733	VMware	8/2/2012 ...
ata-pata-via	0.3.3-2vmw.510.0.0.799733	VMware	8/2/2012 ...
scsi-aacraid	1.1.5.1-9vmw.510.0.0.799733	VMware	8/2/2012 ...
scsi-rste	2.0.2.0088-1vmw.510.0.0.799733	VMware	8/2/2012 ...
ata-pata-cmd64x	0.2.5-3vmw.510.0.0.799733	VMware	8/2/2012 ...
ima-qla4xxx	2.01.31-1vmw.510.0.0.799733	VMware	8/2/2012 ...
net-igb	2.1.11.1-3vmw.510.0.0.799733	VMware	8/2/2012 ...
scsi-qla4xxx	5.01.03.2-4vmw.510.0.0.799733	VMware	8/2/2012 ...
block-cciss	3.6.14-10vmw.510.0.0.799733	VMware	8/2/2012 ...
scsi-aic79xx	3.1-5vmw.510.0.0.799733	VMware	8/2/2012 ...
tools-light	5.1.0-0.0.799733	VMware	8/2/2012 ...
uhci-usb-uhci	1.0-3vmw.510.0.0.799733	VMware	8/2/2012 ...
sata-sata-nv	3.5-4vmw.510.0.0.799733	VMware	8/2/2012 ...
sata-sata-sil24	1.1-1vmw.510.0.0.799733	VMware	8/2/2012 ...
net-ixgbe	3.7.13.6iov-10vmw.510.0.0.7...	VMware	8/2/2012 ...
ipmi-ipmi-msghandler	39.1-4vmw.510.0.0.799733	VMware	8/2/2012 ...
scsi-adp94xx	1.0.8.12-6vmw.510.0.0.799733	VMware	8/2/2012 ...
scsi-fnic	1.5.0.3-1vmw.510.0.0.799733	VMware	8/2/2012 ...
ata-pata-pdc2027x	1.0-3vmw.510.0.0.799733	VMware	8/2/2012 ...
misc-drivers	5.1.0-0.0.799733	VMware	8/2/2012 ...

```

net-enic                1.4.2.15a-1vmw.510.0.0.799733 VMware 8/2/2012 ...
net-be2net              4.1.255.11-1vmw.510.0.0.799733 VMware 8/2/2012 ...
net-nx-nic              4.0.558-3vmw.510.0.0.799733 VMware 8/2/2012 ...
esx-xlibs               5.1.0-0.0.799733 VMware 8/2/2012 ...
net-bnx2x               1.61.15.v50.3-1vmw.510.0.0.... VMware 8/2/2012 ...
ehci-ehci-hcd          1.0-3vmw.510.0.0.799733 VMware 8/2/2012 ...
ohci-usb-ohci          1.0-3vmw.510.0.0.799733 VMware 8/2/2012 ...
net-r8168               8.013.00-3vmw.510.0.0.799733 VMware 8/2/2012 ...
esx-tboot               5.1.0-0.0.799733 VMware 8/2/2012 ...
ata-pata-sil680        0.4.8-3vmw.510.0.0.799733 VMware 8/2/2012 ...
ipmi-ipmi-devintf      39.1-4vmw.510.0.0.799733 VMware 8/2/2012 ...
scsi-mptsas             4.23.01.00-6vmw.510.0.0.799733 VMware 8/2/2012 ...

```

```

vSphere PowerCLI> Export-ExsImageProfile -ImageProfile FINAL -FilePath 'C:\Documents and
Settings\Administrator\Desktop\FINAL.iso' -ExportToIso

```

Upgrading the vCenter Server



Note This upgrade procedure applies to vCenter Server 5.0, 5.0 Update 1 and later, 5.1, and 5.5 versions.

Before You Begin

- Download the upgrade ISO file that contains your desired ESXi image and the desired Cisco Nexus 1000V image.
- See the *Cisco Nexus 1000V and VMware Compatibility Information* document to determine the correct VIB Version, VEM Bundle, Host Build, vCenter Server, and Update Manager versions.

Procedure

Step 1 Navigate to the VMware vSphere installation file.

Note If you have the ISO image, you should mount it on the host.

- Step 2** Double-click **autorun**.
- Step 3** In the **VMware vCenter Installer** screen, click **vCenter Server**.
- Step 4** Click **Install**.
- Step 5** Choose a language and click **OK**.
- Step 6** Click **Next**.
- Step 7** In the **Patent Agreement** screen, click **Next**.
- Step 8** In the **License Agreement** screen, click the **I agree to the terms in the license agreement** radio button.
- Step 9** Click **Next**.
- Step 10** In the **Database Options** screen, click **Next**.
- Step 11** Click the **Upgrade existing vCenter Server database** radio button and check the **I have taken a backup of the existing vCenter Server database and SSL certificates in the folder: C:\ProgramData\VMware\VMware VirtualCenter\SSL**, check box.
- Step 12** From the **Windows Start** Menu, click **Run**.
- Step 13** Enter the name of the folder that contains the vCenter Server database and click **OK**.
- Step 14** Drag a copy of the parent folder (SSL) to the desktop as a backup.
- Step 15** Return to the installer program.
- Step 16** Click **Next**.
- Step 17** In the **vCenter Agent Upgrade** screen, click the **Automatic** radio button.
- Step 18** Click **Next**.
- Step 19** In the **vCenter Server Service** screen, check the **Use SYSTEM Account** check box.
- Step 20** Click **Next**.
- Step 21** Review the port settings and click **Next**.
- Step 22** In the **vCenter Server JVM Memory** screen based on the number of hosts, click the appropriate memory radio button.
- Step 23** Click **Next**.
- Step 24** Click **Install**.
- Step 25** Click **Finish**.
This step completes the upgrade of the vCenter Server.
- Step 26** Upgrade the VMware vSphere Client to your desired ESXi version.
- Step 27** Open the VMware vSphere Client.
- Step 28** From the **Help** menu, choose **About VMware vSphere**.
- Step 29** Confirm that the vSphere Client and the VMware vCenter Server are both the same VMware versions.
- Step 30** Click **OK**, and exit the VMware vSphere Client.

What to Do Next

Complete the steps in [Upgrading the vCenter Update Manager to Release 6.0](#), on page 107.

Upgrading VEMs Using VUM

The steps to upgrade VEMS using VUM are as follows:

Procedure

-
- Step 1** Upgrade the VEM from the VSM. See [Upgrading the VEMs Using VMware Update Manager from Release 4.2\(1\)SV2\(1.1x\) and Later Releases to the Current Release](#), on page 77.
 - Step 2** Upgrade the VEM software. See [Upgrading the VEM Software Using the vCLI](#), on page 81.
 - Step 3** Upgrade both ESX and Cisco Nexus 1000V. See [Combined Upgrade of VMware vSphere and Cisco Nexus 1000V](#), on page 87.
-

Upgrading the VEMs Using VMware Update Manager from Release 4.2(1)SV2(1.1x) and Later Releases to the Current Release



Caution

If removable media is still connected (for example, if you have installed the VSM using ISO and forgot to remove the media), host movement to maintenance mode fails and the VUM upgrade fails.

Before You Begin

When using VUM, the feature `http-server enable` command must be enabled.

Procedure

-
- Step 1** switch# **show vmware vem upgrade status**
Display the current configuration.
 - Step 2** switch# **vmware vem upgrade notify**
Coordinate with and notify the server administrator of the VEM upgrade process.
 - Step 3** switch# **show vmware vem upgrade status**
Verify that the upgrade notification was sent.
 - Note** Verify that the Upgrade Status contains the highlighted text. If the text is not present, check the Upgrade Error line and consult the *Cisco Nexus 1000V Troubleshooting Guide*.
 - Step 4** switch# **show vmware vem upgrade status**
Verify that the server administrator has accepted the upgrade in the vCenter. For more information about how the server administrator accepts the VEM upgrade, see [Accepting the VEM Upgrade](#), on page 80. Coordinate the notification acceptance with the server administrator. After the server administrator accepts the upgrade, proceed with the VEM upgrade.
 - Note** Verify that the Upgrade Status contains the highlighted text. If the text is not present, check the Upgrade Error line and consult the *Cisco Nexus 1000V Troubleshooting Guide*.
 - Step 5** Initiate the VUM upgrade process with the following commands.
 - Note** Before entering the following commands, communicate with the server administrator to confirm that the VUM process is operational.
 - The vCenter Server locks the DVS and triggers VUM to upgrade the VEMs.

- a) switch# **vmware vem upgrade proceed**
- b) switch# **show vmware vem upgrade status**

Note The DVS bundle ID is updated and is highlighted.

If the host is using ESXi 5.0.0 or a later release and your DRS settings are enabled to allow it, VUM automatically VMotions the VMs from the host to another host in the cluster and places the ESXi in maintenance mode to upgrade the VEM. This process is continued for other hosts in the DRS cluster until all the hosts are upgraded in the cluster. For details about DRS settings required and vMotion of VMs, visit the VMware documentation related to Creating a DRS Cluster.

Step 6 switch# **show vmware vem upgrade status**

Check for the upgrade complete status.

Step 7 Clear the VEM upgrade status after the upgrade process is complete with the following commands.

- a) switch# **vmware vem upgrade complete**
- b) switch# **show vmware vem upgrade status**

Step 8 switch# **show module**

Verify that the upgrade process is complete.

The upgrade is complete.

The following example shows how to upgrade VEMs using VUM.



Note

The example may contain Cisco Nexus 1000V versions and filenames that are not relevant to your release. Refer to the *Cisco Nexus 1000V and VMware Compatibility Information* for your specific versions and filenames.

```
switch# show vmware vem upgrade status

Upgrade VIBs: System VEM Image
Upgrade Status:
Upgrade Notification Sent Time:
Upgrade Status Time(vCenter):
Upgrade Start Time:
Upgrade End Time(vCenter):
Upgrade Error:
Upgrade Bundle ID:
  VSM: VEM500-201607300101-BG
  DVS: VEM500-201401164100-BG

switch#
switch# vmware vem upgrade notify
Warning:
Please ensure the hosts are running compatible ESX versions for the upgrade. Refer to
corresponding
"Cisco Nexus 1000V and VMware Compatibility Information" guide.
switch# show vmware vem upgrade status
switch# show vmware vem upgrade status

Upgrade VIBs: System VEM Image
Upgrade Status: Upgrade Availability Notified in vCenter
Upgrade Notification Sent Time: Mon Sep 21 06:43:57 2015
Upgrade Status Time(vCenter):
Upgrade Start Time:
Upgrade End Time(vCenter):
Upgrade Error:
Upgrade Bundle ID:
  VSM: VEM500-201607300101-BG
  DVS: VEM500-201401164100-BG
```

```

switch# show vmware vem upgrade status

switch# show vmware vem upgrade status
Upgrade VIBs: System VEM Image
Upgrade Status: Upgrade Accepted by vCenter Admin
Upgrade Notification Sent Time: Mon Sep 21 06:43:57 2015
Upgrade Status Time(vCenter): Mon Sep 21 09:13:29 2015
Upgrade Start Time:
Upgrade End Time(vCenter):
Upgrade Error:
Upgrade Bundle ID:
    VSM: VEM500-201607300101-BG
    DVS: VEM500-201401164100-BG

switch#
switch# vmware vem upgrade proceed
switch# show vmware vem upgrade status

switch# show vmware vem upgrade status

Upgrade VIBs: System VEM Image
Upgrade Status: Upgrade In Progress in vCenter
Upgrade Notification Sent Time: Mon Sep 21 06:43:57 2015
Upgrade Status Time(vCenter): Mon Sep 21 09:13:29 2015
Upgrade Start Time: Mon Sep 21 06:45:15 2015
Upgrade End Time(vCenter):
Upgrade Error:
Upgrade Bundle ID:
    VSM: VEM500-201607300101-BG
    DVS: VEM500-201607300101-BG

switch#
switch# show vmware vem upgrade status

switch# show vmware vem upgrade status

Upgrade VIBs: System VEM Image
Upgrade Status: Upgrade Complete in vCenter
Upgrade Notification Sent Time: Mon Sep 21 06:57:04 2015
Upgrade Status Time(vCenter): Mon Sep 21 09:13:29 2015
Upgrade Start Time: Mon Sep 21 07:38:41 2015
Upgrade End Time(vCenter): Mon Sep 21 10:09:34 2015
Upgrade Error:
Upgrade Bundle ID:
    VSM: VEM500-201607300101-BG
    DVS: VEM500-201607300101-BG

switch#
switch# vmware vem upgrade complete
switch# show vmware vem upgrade status

switch# show vmware vem upgrade status

Upgrade VIBs: System VEM Image
Upgrade Status:
Upgrade Notification Sent Time:
Upgrade Status Time(vCenter):
Upgrade Start Time:
Upgrade End Time(vCenter):
Upgrade Error:
Upgrade Bundle ID:
    VSM: VEM500-201607300101-BG
    DVS: VEM500-201607300101-BG

switch#
switch(config)# show module
switch# sh module
Mod  Ports  Module-Type                Model                Status
---  -
1    0      Virtual Supervisor Module  Nexus1000V          ha-standby
2    0      Virtual Supervisor Module  Nexus1000V          active *
3    1022   Virtual Ethernet Module    NA                   ok
    
```

```

4 1022 Virtual Ethernet Module NA ok
5 1022 Virtual Ethernet Module NA ok
6 1022 Virtual Ethernet Module NA ok
7 1022 Virtual Ethernet Module NA ok

```

```

Mod Sw Hw
-----
1 5.2(1)SV3(2.1) 0.0
2 5.2(1)SV3(2.1) 0.0
3 5.2(1)SV3(2.1) VMware ESXi 5.1.0 Releasebuild-2323236 (3.1)
4 5.2(1)SV3(2.1) VMware ESXi 5.1.0 Releasebuild-2323236 (3.1)
5 5.2(1)SV3(2.1) VMware ESXi 6.0.0 Releasebuild-3620759 (6.0)
6 5.2(1)SV3(2.1) VMware ESXi 5.5.0 Releasebuild-2068190 (3.2)
7 5.2(1)SV3(2.1) VMware ESXi 6.0.0 Releasebuild-3620759 (6.0)

```

```

Mod Server-IP Server-UUID Server-Name
-----
1 10.197.133.101 NA NA
2 10.197.133.101 NA NA
3 10.197.132.44 7b1a5e63-bcd0-11e0-bd1d-30e4dbc2c3ae NA
4 10.197.132.42 e0829a21-bc61-11e0-bd1d-30e4dbc2ba66 NA
5 10.197.132.43 e6c1a563-bc9e-11e0-bd1d-30e4dbc2baba NA
6 10.197.132.46 db8b80ac-af1d-11e0-a4e7-30e4dbc26b82 NA
7 10.197.132.45 8d8ff0e8-b565-11e0-bd1d-30e4dbc297da NA

```

* this terminal session

```
switch(config)#
```



Note

The lines with the bold characters in the preceding example display that all VEMs are upgraded to the current release.

Accepting the VEM Upgrade

Before You Begin

- The network and server administrators must coordinate the upgrade procedure with each other.
- You have received a notification in the vCenter Server that a VEM software upgrade is available.

Procedure

Step 1 In the vCenter Server, choose **Inventory > Networking**.

Step 2 Click the **vSphere Client DVS Summary** tab to check for the availability of a software upgrade.

Figure 13: vSphere Client DVS Summary Tab



196588

Step 3 Click **Apply upgrade**.

The network administrator is notified that you are ready to apply the upgrade to the VEMs.

Upgrading the VEM Software Using the vCLI

You can upgrade the VEM software by using the vCLI.

Before You Begin

- If you are using vCLI, do the following:
 - You have downloaded and installed the VMware vCLI. For information about installing the vCLI, see the VMware vCLI documentation.
 - You are logged in to the remote host where the vCLI is installed.

**Note**

The vSphere command-line interface (vCLI) command set allows you to enter common system administration commands against ESX/ESXi systems from any machine with network access to those systems. You can also enter most vCLI commands against a vCenter Server system and target any ESX/ESXi system that the vCenter Server system manages. vCLI commands are especially useful for ESXi hosts because ESXi does not include a service console.

- If you are using the **esxupdate** command, you are logged in to the ESX host.
- Check *Cisco Nexus 1000V and VMware Compatibility Information* for compatible versions.
- You have already copied the VEM software installation file to the `/tmp` directory. Do not copy the files to the root (`/`) folder.
- You know the name of the VEM software file to be installed.

Procedure

Step 1 `[root@serialport -]# cd tmp`

Go to the directory where the new VEM software was copied.

Step 2 Determine the upgrade method that you want to use and enter the appropriate command.

- **vihostupdate**
Installs the ESX/ESXi and VEM software simultaneously if you are using the vCLI.
- **esxupdate**
Installs the VEM software from the ESX host `/tmp` directory.

Note You must log in to each host and enter this command. This command loads the software manually on the host, loads the kernel modules, and starts the VEM agent on the running system.

Step 3 For ESXi 5.0.0 or later hosts, enter the appropriate commands as they apply to you.

- a) `~# esxcli software vib install -d /absolute-path/VEM_bundle`
- b) `~# esxcli software vib install -v /absolute-path/vib_file`

Note You must specify the absolute path to the *VEM_bundle* and *vib_file* files. The absolute path is the path that starts at the root of the file system such as `/tmp/vib_file`.

Step 4 Display values with which to compare to *Cisco Nexus 1000V and VMware Compatibility Information* by typing the following commands.

- a) `[root@serialport tmp]# vmware -v`
- b) `root@serialport tmp]# # esxupdate query`
- c) `[root@host212 ~]# . ~# vem status -v`
- d) `[root@host212 ~]# vemcmd show version`

Step 5 `switch# show module`

Display that the VEMs were upgraded by entering the command on the VSM.

If the upgrade was successful, the installation procedure is complete.

The following example shows how to upgrade the VEM software using the vCLI.



Note

The example may contain Cisco Nexus 1000V versions and filenames that are not relevant to your release. Refer to the *Cisco Nexus 1000V and VMware Compatibility Information* for your specific versions and filenames.

```
[root@serialport ~]# cd tmp
[root@serialport tmp]#
esxupdate -b [VMware offline update bundle] update
~ # esxcli software vib install -d /tmp/VEM510-201607300107-BG-release.zip
Installation Result
  Message: Operation finished successfully.
  Reboot Required: false
  VIBs Installed: Cisco_bootbank_cisco-vem-v300-5.2.1.3.2.1.0-3.2.1.VIB
  VIBs Removed:
  VIBs Skipped:
~ #

~ # esxcli software vib install -v /tmp/cross_cisco-vem-vVEM510-201607300107-BG.vib
Installation Result
  Message: Operation finished successfully.
  Reboot Required: false
  VIBs Installed: Cisco_bootbank_cisco-vem-v300-5.2.1.3.2.1.0-3.2.1.VIB
  VIBs Removed:
  VIBs Skipped:
~ #
[root@serialport tmp]# vmware -v -l
VMware ESXi 5.5.0 build-2068190
VMware ESXi 5.5.0 Update 2
~ #

root@serialport tmp]# # esxupdate query
-----Bulletin ID----- Installed-----Summary-----
VEM510-201607300107-BG1 2015-09-20T08:18:22 Cisco Nexus 1000V 5.2(1)SV3(2.1)
```



```

~ # vem status -v

Package vssnet-esxesx2013-release
Version 5.2.1.3.2.1.0-3.2.1
Build 1
Date Wed Feb 17 16:27:37 PST 2016

VEM modules are loaded

VEM modules are loaded

Switch Name      Num Ports  Used Ports  Configured Ports  MTU  Uplinks
vSwitch0         2432      82          128               1500 vmnic0
DVS Name         Num Ports  Used Ports  Configured Ports  MTU  Uplinks
cyp              1024      50          1024              1500 vmnic7,vmnic5,vmnic4

VEM Agent (vemdpa) is running

~ # vemcmd show version
VEM Version: 5.2.1.3.2.1.0-3.2.1
VSM Version: 5.2(1)SV3(2.1)
System Version: VMware ESXi 5.5.0 Releasebuild-2068190
ESX Version Update Level: 2
~ #
switch# show module
switch# sh module
Mod  Ports  Module-Type          Model          Status
---  ---  -
1    0      Virtual Supervisor Module  Nexus1000V    ha-standby
2    0      Virtual Supervisor Module  Nexus1000V    active *
3    1022   Virtual Ethernet Module    NA            ok
4    1022   Virtual Ethernet Module    NA            ok
5    1022   Virtual Ethernet Module    NA            ok
6    1022   Virtual Ethernet Module    NA            ok
7    1022   Virtual Ethernet Module    NA            ok

Mod  Sw          Hw
---  ---  -
1    5.2(1)SV3(2.1)  0.0
2    5.2(1)SV3(2.1)  0.0
3    5.2(1)SV3(2.1)  VMware ESXi 5.1.0 Releasebuild-2323236 (3.1)
4    5.2(1)SV3(2.1)  VMware ESXi 5.1.0 Releasebuild-2323236 (3.1)
5    5.2(1)SV3(2.1)  VMware ESXi 6.0.0 Releasebuild-3620759 (6.0)
6    5.2(1)SV3(2.1)  VMware ESXi 5.5.0 Releasebuild-2068190 (3.2)
7    5.2(1)SV3(2.1)  VMware ESXi 6.0.0 Releasebuild-3620759 (6.0)

Mod  Server-IP      Server-UUID          Server-Name
---  ---  -
1    10.197.133.101  NA                   NA
2    10.197.133.101  NA                   NA
3    10.197.132.44  7b1a5e63-bcd0-11e0-bd1d-30e4dbc2c3ae  NA
4    10.197.132.42  e0829a21-bc61-11e0-bd1d-30e4dbc2ba66  NA
5    10.197.132.43  e6c1a563-bc9e-11e0-bd1d-30e4dbc2baba  NA
6    10.197.132.46  db8b80ac-af1d-11e0-a4e7-30e4dbc26b82  NA
7    10.197.132.45  8d8ff0e8-b565-11e0-bd1d-30e4dbc297da  NA

* this terminal session

switch#

```



Note

The highlighted text in the previous command output confirms that the upgrade was successful.

Upgrading the VEMs Manually from Release 4.2(1)SV2(1.1x) and Later Releases to the Current Release

Before You Begin



Note If VUM is installed, it should be disabled.

To manually install or upgrade the Cisco Nexus 1000V VEM on an ESXi host, follow the steps in [Upgrading the VEM Software Using the vCLI](#), on page 81.

To upgrade the VEMs manually, perform the following steps as network administrator:



Note This procedure is performed by the network administrator. Before proceeding with the upgrade, make sure that the VMs are powered off if you are not running the required patch level.



Caution If removable media is still connected, (for example, if you have installed the VSM using ISO and forgot to remove the media), host movement to maintenance mode fails and the VEM upgrade fails.

Procedure

-
- Step 1** switch# **vmware vem upgrade notify**
Coordinate with and notify the server administrator of the VEM upgrade process.
- Step 2** switch# **show vmware vem upgrade status**
Verify that the upgrade notification was sent.
- Step 3** switch# **show vmware vem upgrade status**
Verify that the server administrator has accepted the upgrade in vCenter Server. For details about the server administrator accepting the VEM upgrade, see [Accepting the VEM Upgrade](#), on page 80. After the server administrator accepts the upgrade, proceed with the VEM upgrade.
- Step 4** Perform one of the following tasks:
- If the ESXi host is not hosting the VSM, proceed to Step 5.
 - If the ESXi host is hosting the VSM, coordinate with the server administrator to migrate the VSM to a host that is not being upgraded. Proceed to Step 5.
- Step 5** switch# **vmware vem upgrade proceed**
Initiate the Cisco Nexus 1000V Bundle ID upgrade process.
- Note** If VUM is enabled in the vCenter environment, disable it before entering the **vmware vem upgrade proceed** command to prevent the new VIBs from being pushed to all the hosts.

Enter the **vmware vem upgrade proceed** command so that the Cisco Nexus 1000V Bundle ID on the vCenter Server gets updated. If VUM is enabled and you do not update the Bundle ID, an incorrect VIB version is pushed to the VEM when you next add the ESXi to the VSM.

Note If VUM is not installed, the “The object or item referred to could not be found” error appears in the vCenter Server task bar. You can ignore this error message.

Step 6 switch# **show vmware vem upgrade status**

Check for the upgrade complete status.

Step 7 Coordinate with and wait until the server administrator upgrades all ESXi host VEMs with the new VEM software release and informs you that the upgrade process is complete.

The server administrator performs the manual upgrade by using the **vihostupdate** command or the **esxcli** command. For more information, see [Upgrading the VEM Software Using the vCLI](#), on page 81.

Step 8 switch# **vmware vem upgrade complete**

Clear the VEM upgrade status after the upgrade process is complete.

Step 9 switch# **show vmware vem upgrade status**

Check the upgrade status once again.

Step 10 switch# **show module**

Verify that the upgrade process is complete.

Note The line with the bold characters in the preceding example display that all VEMs are upgraded to the current release.

The upgrade is complete.

The following example shows how to upgrade VEMs manually.



Note

The example may contain Cisco Nexus 1000V versions and filenames that are not relevant to your release. Refer to the *Cisco Nexus 1000V and VMware Compatibility Information* for your specific versions and filenames.

```
switch# show vmware vem upgrade status
```

```
switch# show vmware vem upgrade status
```

```
Upgrade VIBs: System VEM Image
Upgrade Status:
Upgrade Notification Sent Time:
Upgrade Status Time(vCenter):
Upgrade Start Time:
Upgrade End Time(vCenter):
Upgrade Error:
Upgrade Bundle ID:
```

```
    VSM: VEM500-201607300101-BG
    DVS: VEM500-201401164100-BG
```

```
switch#
```

```
switch# vmware vem upgrade notify
```

```
Warning:
```

```
Please ensure the hosts are running compatible ESX versions for the upgrade. Refer to
corresponding
"Cisco Nexus 1000V and VMware Compatibility Information" guide.
```

```
switch# show vmware vem upgrade status
```

```
switch# show vmware vem upgrade status
```

```

Upgrade VIBs: System VEM Image
Upgrade Status: Upgrade Availability Notified in vCenter
Upgrade Notification Sent Time: Mon Oct 21 06:43:57 2015
Upgrade Status Time(vCenter):
Upgrade Start Time:
Upgrade End Time(vCenter):
Upgrade Error:
Upgrade Bundle ID:
  VSM: VEM500-201607300101-BG
  DVS: VEM500-201401164100-BG

```

```

switch# show vmware vem upgrade status
Upgrade VIBs: System VEM Image
Upgrade Status: Upgrade Accepted by vCenter Admin
Upgrade Notification Sent Time: Mon Oct 21 06:43:57 2015
Upgrade Status Time(vCenter): Mon Oct 21 09:13:29 2015
Upgrade Start Time:
Upgrade End Time(vCenter):
Upgrade Error:
Upgrade Bundle ID:
  VSM: VEM500-201607300101-BG
  DVS: VEM500-201401164100-BG

```

```

switch#
switch# vmware vem upgrade proceed
switch# show vmware vem upgrade status

```

```

switch# show vmware vem upgrade status

Upgrade VIBs: System VEM Image
Upgrade Status: Upgrade In Progress in vCenter
Upgrade Notification Sent Time: Mon Oct 21 06:43:57 2015
Upgrade Status Time(vCenter): Mon Oct 21 09:13:29 2015
Upgrade Start Time: Mon Oct 21 06:45:15 2015
Upgrade End Time(vCenter):
Upgrade Error:
Upgrade Bundle ID:
  VSM: VEM500-201607300101-BG
  DVS: VEM500-201607300101-BG

```

```

switch# show vmware vem upgrade status

```

```

switch# show vmware vem upgrade status

Upgrade VIBs: System VEM Image
Upgrade Status: Upgrade Complete in vCenter
Upgrade Notification Sent Time: Mon Oct 21 06:57:04 2015
Upgrade Status Time(vCenter): Mon Oct 21 09:13:29 2015
Upgrade Start Time: Mon Oct 21 07:38:41 2015
Upgrade End Time(vCenter): Mon Oct 21 10:09:34 2015
Upgrade Error:
Upgrade Bundle ID:
  VSM: VEM500-201607300101-BG
  DVS: VEM500-201607300101-BG

```

```

switch#
switch# vmware vem upgrade complete
switch# show vmware vem upgrade status

```

```

switch# show vmware vem upgrade status

```

```

Upgrade VIBs: System VEM Image
Upgrade Status:
Upgrade Notification Sent Time:
Upgrade Status Time(vCenter):
Upgrade Start Time:
Upgrade End Time(vCenter):
Upgrade Error:
Upgrade Bundle ID:
  VSM: VEM500-201607300101-BG
  DVS: VEM500-201607300101-BG

```

```

switch(config)# show module
Mod  Ports  Module-Type                Model                Status
-----
1    0      Virtual Supervisor Module  Nexus1000V          ha-standby
2    0      Virtual Supervisor Module  Nexus1000V          active *
3    1022   Virtual Ethernet Module    NA                   ok
4    1022   Virtual Ethernet Module    NA                   ok
5    1022   Virtual Ethernet Module    NA                   ok
6    1022   Virtual Ethernet Module    NA                   ok
7    1022   Virtual Ethernet Module    NA                   ok

Mod  Sw                Hw
-----
1    5.2(1)SV3(2.1)   0.0
2    5.2(1)SV3(2.1)   0.0
3    5.2(1)SV3(2.1)   VMware ESXi 5.1.0 Releasebuild-2323236 (3.1)
4    5.2(1)SV3(2.1)   VMware ESXi 5.1.0 Releasebuild-2323236 (3.1)
5    5.2(1)SV3(2.1)   VMware ESXi 6.0.0 Releasebuild-3620759 (6.0)
6    5.2(1)SV3(2.1)   VMware ESXi 5.5.0 Releasebuild-2068190 (3.2)
7    5.2(1)SV3(2.1)   VMware ESXi 6.0.0 Releasebuild-3620759 (6.0)

Mod  Server-IP          Server-UUID              Server-Name
-----
1    10.197.133.101    NA                        NA
2    10.197.133.101    NA                        NA
3    10.197.132.44     7b1a5e63-bcd0-11e0-bd1d-30e4dbc2c3ae  NA
4    10.197.132.42     e0829a21-bc61-11e0-bd1d-30e4dbc2ba66  NA
5    10.197.132.43     e6c1a563-bc9e-11e0-bd1d-30e4dbc2baba  NA
6    10.197.132.46     db8b80ac-af1d-11e0-a4e7-30e4dbc26b82  NA
7    10.197.132.45     8d8ff0e8-b565-11e0-bd1d-30e4dbc297da  NA

* this terminal session
    
```

Combined Upgrade of VMware vSphere and Cisco Nexus 1000V

You can perform a combined upgrade of VMware vSphere and Cisco Nexus 1000V.

If any of the hosts are running ESX 4.0 when the VSM is upgraded, the **installer** command displays that some VEMs are incompatible. You can proceed if you are planning a combined upgrade of the Cisco Nexus 1000V 4.2(1)SV1(4), 4.2(1)SV1(4a), 4.2(1)SV2(2.1), and ESX 4.0/4.1 to current release with ESX 5.0/5.1/5.5/6.0.



Note Starting with the 4.2(1)SV2(2.1) release, during an VSM upgrade, if you have incompatible hosts attached to the VSM you will be allowed to upgrade from the current release of Cisco Nexus 1000V software to the later releases. You will see a warning message on incompatible host when you upgrade. Ignore the warning message and continue with the upgrade and the VSM will be upgraded to the latest version. You can perform a combined upgrade on the incompatible hosts.



Note A combined upgrade is supported only for vCenter Server 5.0 Update 1 or later.

To perform a combined upgrade, follow the tasks documented in [Upgrading from VMware Releases 5.x to VMware Release 6.0](#), on page 105

Required Task After Upgrade—Changing the VEM Feature Level

After upgrading to Release 5.2(1)SV3(1.x), you must update the VEM feature level to the corresponding Release. After you perform this task, the new features in Release 5.2(1)SV3(1.x) are available on the Cisco Nexus 1000V and you have the option to increase the VLAN and port channel resource limits.

Before You Begin

- VSM and VEM have been upgraded to Release 5.2(1)SV3(1.x).

Procedure

Step 1 switch# **configure terminal**
Enters global configuration mode.

Step 2 switch(config)# **show system vem feature level**
Displays the current VEM feature level. The current feature level should be 5.2(1)SV3(1.x).

Step 3 switch(config)# **system update vem feature level** *value*
Configures the VEM feature level.

Note When you run the **system update vem feature level** command after upgrading from Release 5.2(1)SV3(1.6) to Release 5.2(1)SV3(1.15), it displays the following three versions:

- 5.2(1)SV3(1.7)
- 5.2(1)SV3(1.10)
- 5.2(1)SV3(1.15)
- 5.2(1)SV3(2.1)

You must select 5.2(1)SV3(2.1) to update the VEM feature level to Release 5.2(1)SV3(2.1).

Step 4 switch(config)# **vdc** *switch-name*
Enters VDC configuration mode for the specified switch.

Step 5 switch(config-vdc)# **limit-resource port-channel minimum** *value* **maximum** *value*
Configures the port channel resource limit.

Step 6 switch(config-vdc)# **limit-resource vlan minimum** *value* **maximum** *value*
Configures the VLAN resource limit

Step 7 switch(config-vdc)# **show resource**
Displays the updated values.

Step 8 switch(config-vdc)# **exit**
Exits the current configuration mode.

Step 9 (Optional) switch(config)# **copy running-config startup-config**
Saves the change persistently through reboots and restarts by copying the running configuration to the startup configuration.

This example shows how to update the VEM feature level after upgrading to Release 5.2(1)SV3(1.x).

```
switch# configure terminal
Enter configuration commands, one per line.  End with CNTL/Z.
switch(config)# system update vem feature ?
    level Updating vem feature level

switch(config)# system update vem feature level ?
    <CR>
    <1-50> Version number index from the list above

switch(config)# system update vem feature level
Feature          Version
Level            String
-----
1                4.2(1)SV2(2.1)
2                4.2(1)SV2(2.2)
3                4.2(1)SV2(2.3)
4                5.2(1)SV3(1.1)
5                5.2(1)SV3(1.2)
6                5.2(1)SV3(1.3)
7                5.2(1)SV3(1.4)
8                5.2(1)SV3(1.5)
9                5.2(1)SV3(1.6)
10               5.2(1)SV3(1.7)
11               5.2(1)SV3(1.10)
12               5.2(1)SV3(1.15)
13               5.2(1)SV3(2.1)
switch(config)#
switch(config)# system update vem feature level 13
switch(config)# copy running-config startup-config
```

Simplified Upgrade Process

Combined Upgrade

You can upgrade the VEM and ESX version simultaneously. It requires vSphere version 5.0 Update1 and later versions. It is supported in Cisco Nexus 1000V Release 4.2(1)SV1(5.2) and later. This upgrade can be implemented manually or by using VUM.

Selective Upgrade

You can upgrade a selective set of VEMs and a few hosts or clusters at a time in a single maintenance window. This enables incremental upgrades during short maintenance windows. It is supported with combined upgrades of VEM and ESX, and also with manual upgrades of VEMs only. It is supported for VUM-based combined upgrades with select hosts or clusters using the GUI. It is not supported with VUM-based upgrades of VEMs alone. To upgrade manually using this procedure follow these general steps:

- Identify the cluster or set of hosts in a cluster.
- Place the selected hosts in maintenance mode (to vacate the VMs).
- Upgrade the VEM image on the hosts using the manual command or scripts.
- Take the hosts out of maintenance mode, allowing Distributed Resource Scheduler (DRS) to rebalance VMs.

Allowed Infrastructure Operations Under Selective Upgrade

These operations are allowed under selective upgrades:

- vMotion of VMs with the following releases:
 - pre-5.2(1)SV3(1.x) to 5.2(1)SV3(1.x)
 - 5.2(1)SV3(1.x) to pre-5.2(1)SV3(1.x)
 - 5.2(1)SV3(1.x) to 5.2(1)SV3(1.x)
 - pre5.2(1)SV3(1.x) to pre-5.2(1)SV3(1.x)
- VEM restart
- Host Reboot
- Add modules in 5.2(1)SV3(1.x)
- Add or remove ports vEth ports
- Shut or no-shut on port
- Migrate ports to or from vSwitch
- Add or delete VLAN or VLAN ranges

Background Upgrade

You can upgrade VEMs without a maintenance window for VEMs. You use the manual procedure to upgrade VEMs during production. Place the host in maintenance mode, upgrade the VEM, and remove the host from the maintenance mode. You do not have to shut off HA Admission Control and such (as you would during VUM upgrades). You must ensure the spare capacity in the cluster and perform a health check before the upgrade. To upgrade using this procedure follow these general steps:

- Upgrade the VSM first as usual. This may be done in a maintenance window
- Place one host at a time in maintenance mode (to vacate the VMs)
- Upgrade the VEM image on that host using manual commands or scripts
- Take the host out of maintenance mode, allowing the DRS to rebalance the VMs.
- Repeat the same procedure for every host in the DVS.



Note Make sure there is enough spare capacity for HA and that all required ports have system profiles (such as mgmt vmk). Check the host health before upgrading.

Extended Upgrade

You can modify configurations between the upgrade maintenance windows. VSM configuration changes are allowed where you can add or remove modules, port configurations, VLANs, and other similar changes. If a set of hosts are upgraded to the latest VEM version using the Selective Upgrade or the Background Upgrade, the remaining set of hosts will remain in older VEM versions. During that time, various Cisco Nexus 1000V configuration changes are allowed between maintenance windows.



Note Do not make configuration changes during a maintenance window when the VEMs are being upgraded.

The list of allowed configuration changes are as follows:

- Add or remove modules
- Add or remove ports (ETH and VETH)
- Shut or no-shut a port
- Migrate ports to or from a vswitch
- Change port modes (trunk or access) on ports
- Add or remove port profiles
- Modify port profiles to add or remove specific features such as VLANs, ACLs, QoS, or PortSec.
- Change port channel modes in uplink port profiles
- Add or delete VLANs and VLAN ranges
- Add or delete static MACs in VEMs



Note Queuing configuration changes are not supported on QoS.

Migrating from Layer 2 to Layer 3

Layer 3 Advantages

The following lists the advantages of using a Layer 3 configuration over a Layer 2 configuration:

- The VSM can control the VEMs that are in a different subnets.
- The VEMs can be in different subnets.
- Because the VEMs can be in different subnets, there is no constraint on the physical location of the hosts.
- Minimal VLAN configurations are required for establishing the VSM-VEM connection when compared to Layer 2 control mode. The IP address of the VEM (Layer 3 capable vmknic's IP address) and the VSM's control0/mgmt0 interface are the only required information.
- In the VSM, either the mgmt0 or the control0 interface can be used as the Layer 3 control interface. If mgmt0 is used, there is no need for another IP address as the VSM's management IP address is used for VSM-VEM Layer 3 connection.
- If the management VMKernel (vmk0) is used as the Layer 3 control interface in the VEM, there is no need for another IP address because the host's management IP address is used for VSM-VEM Layer 3 connectivity.

**Note**

These advantages are applicable only for ESX-Visor hosts. On ESX-Cos hosts, a new VMKernel must be created.

Layer 2 to 3 Conversion Tool

About VSM-VEM Layer 2 to 3 Conversion Tool

Use the VSM-VEM Layer 2 to 3 Conversion Tool as an optional, simplified method to migrate from Layer 2 to Layer 3 mode. The tool enables you to do the following:

- Check whether the prerequisites are met for the migration from L2 to L3 mode.
- Migrate the VSM from Layer 2 to Layer 3 Mode, with user interaction.

In the process of migration, the tool creates a port profile. You can use port profiles to configure interfaces, which you can assign to other interfaces to give them the same configuration. The VSM-VEM Layer 2 to 3 Conversion Tool also gives you the option of retrieving the IP addresses from a local file (static).

Prerequisites for Using VSM-VEM Layer 2 to 3 Conversion Tool

The L2-L3_CT.zip file contains the applications required to run VSM-VEM Layer 2 to 3 Conversion Tool. Before you begin:

- Log in as administrator to use this conversion tool script.
- Download the L2-L3_CT.zip file from the [CCO Download Center](#).
- Install Tool Conversion Language (TCL) version 8.4 or later on the workstation.
- Install VMware PowerShell API version 5.0 or later on both the vCenter and the workstation.
- Install [OpenSSH](#) on the workstation.
- In the workstation environment variables, add `installation_directory_for_OpenSSH\bin` directory to the end of the Windows path variable.
- Ensure that VLANs are allowed on the uplinks.

**Note**

You must install vCenter, VSM, and OpenSSH with admin privileges.

Using VSM-VEM Layer 2 to 3 Conversion Tool

Procedure

- Step 1** On your workstation, unzip the L2-L3_CT.zip file to any folder.
When you unzip the file, a Pre-Migrate-Check-Logs folder is created that holds all the running logs. Debugging log files will be created in this folder.
- Step 2** Inside the L2-L3_CT folder, run migration.bat as an administrator.
This starts the VSM-VEM Layer 2 to 3 Conversion Tool.
- Step 3** Enter the VSM IP address.
- Step 4** Enter the VSM username.
- Step 5** Enter the vCenter IP.
- Step 6** Enter the vCenter username.
- Step 7** Enter the VSM password.
- Step 8** Enter the vCenter password.
The migration tool begins creating the .csv file for the user, and then checks for a port profile with layer 3 capability.
- Step 9** If there is no layer 3-capable port profile, the tool will prompt for the creation of one. If you don't want to create a layer-3 capable port profile, skip to the next step.
- a) Enter yes to confirm when asked to create 1 layer 3-capable port profile.
 - b) Enter a layer 3 port profile name.
 - c) Enter access VLAN ID
- This creates a port profile with the required configuration. You can select this port profile when prompted by the tool. The migration tool checks for connectivity between VSM, vCenter, and VEM modules. Wait for the message to display that all connectivity is fine.
- Step 10** Enter yes to continue when asked if you want to continue.
The migration tool proceeds to create an extract .csv file.
- Step 11** Open the extract.csv file (in C:\Windows\Temp).
- Step 12** Enter the vmknix IP details at the end of the text, delimited by semicolons, and save the file as convert.csv.
- Step 13** Press any key to continue.
- Step 14** Enter yes to confirm when asked if you are sure you completed the required steps.
- Step 15** Enter the VSM password.
- Step 16** Enter the vCenter password.
The migration tool connects to the vCenter and VSM of the user.
- Step 17** Enter yes to confirm when asked if you want to continue.
The migration process continues.
- Step 18** Enter the port profile name from the list of port profiles that appears at the prompt.

Once the port profile is selected, the max port value is automatically changed to 128.

- Step 19** Enter yes to confirm when asked if you have updated convert.csv file as per the instructions.
- Step 20** Enter yes to confirm, when asked if you want to continue.
The tool checks the connectivity between VSM, vCenter, and VEM modules. A message is displayed that the addition to vmknics are successful and all connectivity is fine. The **VmkNicAddingToHost** window will remain open until the configuration is complete.
- Step 21** Enter yes to confirm that you would like to proceed with mode change from L2 to L3.
- Step 22** Enter yes to confirm when asked if you wish to continue.
Wait for the SUCCESSFULLY COMPLETED MIGRATION message to display. The migration from layer 2 to layer 3 is now complete. The operating mode should now be listed as L3.

Using Extract Mode

You can use Extract Mode to extract the attached VEM states and save them to the Extract.csv file, which is located in C:\Windows\Temp.

Procedure

	Command or Action	Purpose
Step 1	Choose extract mode when prompted by VSM-VEM Layer 2 to 3 Conversion Tool. You can now view the data in the Extract.csv file in the Windows temp folder of your workstation.	This mode will not migrate the VSM.

Using Convert Mode

You can use Convert Mode to migrate the VSM from Layer 2 to Layer 3.

Procedure

	Command or Action	Purpose
Step 1	Rename the Extract.csv file to Convert.csv	The migration tool will retrieve the data from the Convert.csv file.
Step 2	Populate your Convert.csv file (in C:\Windows\Temp) with the vmknics IP address and netmask.	
Step 3	Run migration.bat.	This will migrate the VSM mode from Layer 2 to Layer 3 .

Example

The following example shows how to use the VSM-VEM Layer 2 to 3 Conversion Tool.

```

Enter VSM IP:
enter VSM Username:
Enter VC IP:
enter VC Username:
Enter VSM password:
Enter VC password:
create the Csv File for User I/P: C:\windows\temp\extract.csv
#### VSM DETAILS STARTS #####
.....
##### VC DETAILS END #####
.....
.....
Operating Mode : L2
Operatoinal Mode is L2 Currently .....
#####
List of port profiles on VSM:
-----
#####
=====
CHECK 1: Checking for a port profile with capability l3control set and Enabled.
.....
=====
There is not even One L3 Capable Port Profile

Do you want to Create One L3 Capable Port Profile
Please Give Option (Yes/No):Yes
Please Enter L3 PortProfile Name: L3-Control
Please Give Access Vlan Id :5
Creating L3 Port Profile : L3-Control with Access Vlan : 5
.....
.....
L3 capable port profiles: L3-Control
Modules Registered:[10.105.228.116]
=====
CHECK 3: Checking for connectivity between VSM and VC, VSM and VEM Modules
=====
.....
.....
#####
## All connectivity is fine
#####
Please wait for a few minutes.
Do you want to Continue,Please Type ...(yes/no):yes
Migration Tool Proceeding ...
Creating csv file: C:\windows\temp\extract.csv
Modules : 10.105.228.116
#####
Modules Registered:[3 10.105.228.116]
#####

#####
#####
Extraction of VEM connection status has been dumped in: C:\windows\temp\extract.
csv
Please rename this file before using Convert Mode
Update the VMKNic IP and NetMask for all disconnected entries
#####
#####!
#####!
!Open c:\windows\temp\Extract.csv and save as Convert.csv (in the same directory
)
!Enter the VMKNic IP and netmask in the Convert.csv file as shown below
!VEM_Host_IP;PPConnectionStatus;Vem_Vmk_IP;NetMask!
!PPConnectionStatus Should not be changed!
!10.10.10.12;DisConnected;10.10.10.100;255.255.255.0!
!After Updating the IP and Netmask, save the file in the same directory
!#####

```

```

#####!
Press any key to continue . . .
Are you sure you completed the above steps? (yes/no):yes

#####

##Tool expects this File have an IP/Netmask given for disconnected VEM in the correct format : C:\windows\temp\Convert.csv

##10.10.10.12;DisConnected;10.10.10.100;255.255.255.0

#####
VSM password required 10.105.228.115:

VC password required 10.105.228.113:

create the Csv File for User I/P: C:\windows\temp\extract.csv
.....
.....
## All connectivity is fine

#####
Please wait for a few minutes.
Do you want to Continue,Please Type ....(yes/no):yes
Migration Tool Proceeding ....
.....
.....
#####
Name the port profile you want to proceed with : [l3-pp]
Please type any port profile mentioned above      |:l3-pp
You Selected : l3-pp
.....
.....
#####
## Have you created a Convert.csv file with a proper VMKNic IP and NetMask?
## In the C:\windows\temp\Convert.csv file for disconnected VEMs.
#####
Have you Updated C:\windows\temp\Convert.csv as per the above instructions?(Yes)
:yes
Do you want to Continue,Please Type ....(yes/no):yes
Migration Tool Proceeding ....
.....
.....

Addition to VmKNics are successful
## All connectivity is Fine
.....
.....
#####

Would You Like to Proceed with Mode Change from L2 to L3...(yes/no):yes
Do you want to Continue,Please Type ....(yes/no):yes
Migration Tool Proceeding ....
.....
.....
switch#
Operating Mode : L3
Operatoinal Mode is L3 Currently
Svs Connection Mode : L3
Vem IP : 10.10.10.108 Connected Back
.....
.....
All VEMs are back: pass
=====SUCCESSFULLY COMPLETED MIGRATION=====

```

Interface Comparisons Between mgmt0 and control0

The following describes the differences between using a mgmt0 interface or a control0 interface:

- On the VSM, there are two ways of connectivity via the mgmt0 or control0 interface.
- Setting mgmt0 as Layer 3 interface uses the mgmt0 interface on the VSM.
- The control0 interface is a special interface created for Layer 3 connectivity.
- The Layer 3 interface on the VEM is selected by designating the interface with the Layer 3 control capability.
- The egress control traffic route is decided by the VMware routing stack.
- On a VEM, the management vmknic (vmk0) can be used for Layer 3 control connectivity if it is managed by the Cisco Nexus 1000V and is designated with the Layer 3 control capability.

Configuring the Layer 3 Interface

Configure either the control0 (see Step 1) or mgmt0 interface (see Step 2).

Procedure

Step 1 Configuring the control0 interface.

Note When using control0 as the control interface on the VSM, the control0 interface must be assigned with an IP address.

- a) Configure the IP address.

```
switch# configure terminal
switch(config)# interface control 0
switch(config-if)# ip address 5.5.5.2 255.255.255.0
```

- b) Display the running configuration of the control0 interface.

```
switch# show running-config interface control 0
!Command: show running-config interface control0
!Time: Mon DEC 02 02:41:47 2015
version 5.2(1)SV3(2.1)
interface control0
  ip address 5.5.5.2/24
```

Step 2 Configure the mgmt0 interface.

Note When using mgmt0 as the control interface, no configuration on the VSM is required as the mgmt0 interface is assigned with the host's management IP address.

- a) Display the running configuration of the mgmt0 interface.

```
switch# show running-config interface mgmt 0
!Command: show running-config interface mgmt0
!Time: Mon DEC 02 02:43:25 2015
version 5.2(1)SV3(2.1)
interface mgmt0
  ip address 10.104.249.37/27
```

Creating a Port Profile with Layer 3 Control Capability

Before You Begin

- You are creating a port profile with Layer 3 control capability.
- Allow the VLAN that you use for VSM to VEM connectivity in this port profile.
- Configure the VLAN as a system VLAN.



Note

VEM modules will not register to the VSM before a vmkernel interface (vmk) is migrated to a Layer 3 control capable port profile. You must migrate a vmk to the Layer 3 port profile after migrating host vmnics to Ethernet port profiles. Migrate your management vmkernel interface into the Layer 3 capable port profile. Do not use multiple vmkernel interfaces on the same subnet.

Procedure

Step 1 Create a Layer 3 port profile.

```
VSM_1# configure terminal
VSM_1(config)# port-profile type vethernet l3_control
VSM_1(config-port-prof)# switchport mode access
VSM_1(config-port-prof)# switchport access vlan 3160
VSM_1(config-port-prof)# capability l3control
VSM_1(config-port-prof)# vmware port-group
VSM_1(config-port-prof)# state enabled
VSM_1(config-port-prof)# no shutdown
```

Step 2 Display the port profile.

```
VSM_1# show port-profile name l3_control
port-profile l3_control
  type: Vethernet
  description:
  status: enabled
  max-ports: 32
  min-ports: 1
  inherit:
  config attributes:
    switchport mode access
    switchport access vlan 3160 (Allow the VLAN in access mode.)
    no shutdown
  evaluated config attributes:
    switchport mode access
    switchport access vlan 3160
    no shutdown
  assigned interfaces:
    Vethernet1
  port-group: l3_control
  system vlans: 3160 (Configure the VLAN as a system VLAN.)
  capability l3control: yes (Configure capability l3 control.)
  capability iscsi-multipath: no
```



```

capability vxlan: no
capability l3-vn-service: no
port-profile role: none port-binding: static

```

Creating a VMKernel on the Host

Procedure

-
- Step 1** Log in to the vCenter Server.
 - Step 2** Choose **Home > Inventory > Hosts and Clusters**.
 - Step 3** Choose the host.
 - Step 4** Click the **Configuration** tab.
 - Step 5** In the Hardware pane, choose **Networking**.
 - Step 6** Click the **vSphere Distributed Switch** button.
 - Step 7** Go to **Manage Virtual Adapters**.
 - Step 8** Add and create a new VMKernel.
 - Note** The management vmkernel can also be used as a Layer 3 control interface. For ESX-Visor hosts only. Migrate your management vmkernel interface into the Layer 3 capable port profile. Do not use multiple vmkernel interfaes on the same subnet.
 - Step 9** Assign the VMkernel to the port profile created in [Creating a Port Profile with Layer 3 Control Capability, on page 98](#).
 - Step 10** Assign an IP address.
-

Configuring the SVS Domain in the VSM

Before You Begin

The control0 or mgmt0 interface can be assigned as the Layer 3 control interface.

Procedure

-
- Step 1** Disconnect the VSM to vCenter Server connection.

```

switch# configure terminal
switch(config)# svs connection toVC
switch(config-svs-conn)# no connect
switch(config-svs-conn)# exit

```
 - Step 2** (Optional) Remove the control and the packet VLAN configuration.

```

switch(config)# svs-domain
switch(config-svs-domain)# no control vlan
switch(config-svs-domain)# no packet vlan

```

Step 3 Change the svcs mode from Layer 2 to Layer 3 with the mgmt0 interface as the Layer 3 control interface.

```
switch(config-svs-domain)# svcs mode l3 interface mgmt0  
switch(config-svs-domain)# exit
```

Note If the control0 interface is being used as the Layer 3 control interface, enter the **svcs mode l3 interface control0** command:

Step 4 Restore the VSM to vCenter Server connection.

```
switch(config)# svcs connection toVC  
switch(config-svs-conn)# connect  
switch(config-svs-conn)# end
```

Note After entering the **svcs connection toVC** command, the module is detached and reattached in Layer 3 mode. If this delay is more than six seconds, a module flap occurs. This does not affect the data traffic.

Step 5 Display the SVS domain configuration.

```
switch# show svcs domain  
SVS domain config:  
  Domain id:      3185  
  Control vlan:  NA  
  Packet vlan:   NA  
  L2/L3 Control mode: L3  
  L3 control interface: mgmt0  
  Status: Config push to VC successful.
```

Note: Control VLAN and Packet VLAN are not used in L3 mode.



Upgrading a Standalone VSM

This chapter contains the following sections:

- [Upgrading a System with a Standalone VSM, page 101](#)
- [Upgrading a Standalone VSM, page 101](#)

Upgrading a System with a Standalone VSM

Upgrading a Standalone VSM



Note

The example may contain Cisco Nexus 1000V versions and filenames that are not relevant to your release. Refer to the *Cisco Nexus 1000V and VMware Compatibility Information* for your specific versions and filenames.

Procedure

- Step 1** Log in to the VSM on the console.
- Step 2** Log in to Cisco.com to access the links provided in this document.
To log in, go to the URL <http://www.cisco.com/> and click **Log In** at the top of the page. Enter your Cisco username and password.
- Note** Unregistered Cisco.com users cannot access the links provided in this document.
- Step 3** Access the Software Download Center by using this URL: <http://www.cisco.com/public/sw-center/index.shtml>
- Step 4** Navigate to the download site for your switch.
You see links to the download images for your switch.
- Step 5** Select and download the Cisco Nexus 1000V zip file and extract the kickstart and system software files to a server.

Step 6 Ensure that the required space is available for the image files to be copied.

```
switch# dir bootflash:
.
.
.
Usage for bootflash://
  485830656 bytes used
 1109045248 bytes free
 1594875904 bytes total
```

Tip We recommend that you have the kickstart and system image files for at least one previous release of the Cisco Nexus 1000V software on the system to use if the new image files do not load successfully.

Step 7 Delete unnecessary files to make space available if you need more space on the VSM bootflash,

Step 8 If you plan to install the images from the bootflash:, copy the Cisco Nexus 1000V kickstart and system images to the active VSM bootflash using a transfer protocol. You can use ftp:, tftp:, scp:, or sftp:. The examples in this procedure use scp:.

Note When you download an image file, change to your FTP environment IP address or DNS name and the path where the files are located.

```
switch# copy scp://user@scpserver.cisco.com//downloads/
nexus-1000v-kickstart.5.2.1.SV3.2.1.bin
switch# copy scp://user@scpserver.cisco.com//downloads/
nexus-1000v-kickstart.5.2.1.SV3.2.1.bin
```

Step 9 Read the release notes for the related image file. See the *Cisco Nexus 1000V Release Notes*.

Step 10 Determine the VSM status.

```
switch# show system redundancy status
Redundancy role
-----
      administrative:  standalone
      operational:    standalone

Redundancy mode
-----
      administrative:  HA
      operational:    None

This supervisor (sup-1)
-----
      Redundancy state:  Active
      Supervisor state:  Active
      Internal state:    Active with no standby

Other supervisor (sup-2)
-----
      Redundancy state:  Not present
```

Step 11 Save the running configuration to the start configuration.

```
switch# copy running-config startup-config
```

Step 12 Update the boot variables and module images on the VSM.

```
switch# install all system bootflash:nexus-1000v.5.2.1.SV3.2.1.bin kickstart
bootflash: nexus-1000v-kickstart.5.2.1.SV3.2.1.bin
```

```
Verifying image bootflash:/nexus-1000v-kickstart-5.2(1)SV3(2.1).bin for boot variable
"kickstart".
[#####] 100% -- SUCCESS
```

```

Verifying image bootflash:/nexus-1000v-5.2(1)SV3(2.1).bin for boot variable "system".
[#####] 100% -- SUCCESS

Verifying image type.
[#####] 100% -- SUCCESS

Extracting "system" version from image bootflash:/nexus-1000v.5.2(1)SV3(2.1).bin.
[#####] 100% -- SUCCESS

Extracting "kickstart" version from image bootflash:/nexus-1000v-kickstart.5.2(1)SV3(2.1).bin.
[#####] 100% -- SUCCESS

Notifying services about system upgrade.
[#####] 100% -- SUCCESS
    
```

```

Compatibility check is done:
Module  bootable          Impact  Install-type  Reason
-----  -
          1             yes      disruptive      reset  Reset due to single supervisor
    
```

```

Images will be upgraded according to following table:
Module  Image          Running-Version  New-Version  Upg-Required
-----  -
          1             system          4.2(1)SV2(2.1)  5.2(1)SV3(2.1)  yes
          1             kickstart       4.2(1)SV2(2.1)  5.2(1)SV3(2.1)  yes
    
```

```

Module  Running-Version  ESX Version          VSM Compatibility  ESX Compatibility
-----  -
          3             4.2(1)SV2(2.1)    VMware ESXi 5.0.0  COMPATIBLE          COMPATIBLE
                               Releasebuild-1311175 (3.0)
    
```

```

Switch will be reloaded for disruptive upgrade.
Do you want to continue with the installation (y/n)? [n]
    
```

Step 13 Continue with the installation by pressing Y.

Note If you press N, the installation exits gracefully.

Install is in progress, please wait.

```

Setting boot variables.
[#####] 100% -- SUCCESS
    
```

```

Performing configuration copy.
[#####] 100% -- SUCCESS
    
```

Finishing the upgrade, switch will reboot in 10 seconds.

Step 14 After the switch completes the reload operation, log in and verify that the switch is running the required software version.

Example:

```

switch# show version
Cisco Nexus Operating System (NX-OS) Software
TAC support: http://www.cisco.com/tac
Documents: http://www.cisco.com/en/US/products/ps9372/tsd_products_support_series_home.html
Copyright (c) 2002-2016, Cisco Systems, Inc. All rights reserved.
The copyrights to certain works contained herein are owned by
other third parties and are used and distributed under license.
Some parts of this software are covered under the GNU Public
License. A copy of the license is available at
http://www.gnu.org/licenses/gpl.html.

Software
kickstart: version 5.2(1)SV3(2.1)
system: version 5.2(1)SV3(2.1)
kickstart image file is: bootflash:///n1000v-dk9-kickstart.5.2(1)SV3(2.1).bin
kickstart compile time: 1/25/2016 22:00:00 [01/26/2016 05:51:47]
system image file is: bootflash:///n1000v-dk9.5.2(1)SV3(2.1).bin
system compile time: 6/25/2016 22:00:00 [06/22/2016 06:46:26]

Hardware
cisco Nexus 1000V Chassis ("Virtual Supervisor Module")
Intel(R) Xeon(R) CPU E5-2660 with 4126584 kB of memory.
Processor Board ID T5056A10FC9

Device name: vsm
bootflash: 2059572 kB

System uptime is 2 days, 17 hours, 13 minutes, 16 seconds

Kernel uptime is 2 day(s), 17 hour(s), 14 minute(s), 22 second(s)

plugin
Core Plugin, Ethernet Plugin, Virtualization Plugin
...

```

What to Do Next

Continue to [Upgrading the VEMs Manually from Release 4.2\(1\)SV2\(1.1x\) and Later Releases to the Current Release](#), on page 84.



Installing and Upgrading VMware

This chapter contains the following sections:

- [Upgrading from VMware Releases 5.x to VMware Release 6.0, page 105](#)
- [Installing VMware Release 5.x and 6.x Patches, page 112](#)
- [Verifying the Build Number and Upgrade, page 116](#)

Upgrading from VMware Releases 5.x to VMware Release 6.0

The steps to upgrade are as follows:



Note

Do not install VMware vSphere 5.5 Patch 2702864 with Cisco Nexus 1000V. The VMware vSphere 5.5 Patch 2702864 is not supported on Cisco Nexus 1000V.

Procedure

- Step 1** [Installing the vCenter Server , on page 106](#)
 - Step 2** [Upgrading the vSphere Client , on page 106](#)
 - Step 3** [Upgrading the vCenter Update Manager to Release 6.0, on page 107](#)
 - Step 4** [Creating a Customized Upgrade ISO with a VMware ESX Image and a Cisco Nexus 1000V VEM Image, on page 108](#)
 - Step 5** Installing VMware Release 5.x or 6.x Patches:
 - [Creating the Host Patch Baseline for 5.x or 6.x Patches, on page 112](#)
 - [Upgrading the ESXi Hosts to Release 5.x or 6.x Patches Using VMware Update Manager, on page 112](#)
 - [Upgrading the ESXi Hosts to Release 5.x or 6.x Using the CLI , on page 113](#)
 - Step 6** [Verifying the Build Number and Upgrade, on page 116](#)
-

Installing the vCenter Server

Before You Begin

- Download the upgrade ISO file that contains the ESXi image and the Cisco Nexus 1000V software image files.
- See the *Cisco Nexus 1000V and VMware Compatibility Information* document to determine the correct VIB Version, VEM Bundle, Host Build, vCenter Server, and Update Manager versions.

Procedure

- Step 1** Mount the vCenter Server 6.0 ISO image.
- Step 2** Unzip the ISO image.
- Step 3** If autorun doesn't start, double-click **autorun.exe**.
- Step 4** In the VMware vCenter Installer window, select **vCenter Server for Windows** and click **Install**.
- Step 5** Click **Next**.
- Step 6** Accept the license agreements.
- Step 7** Enter the vCenter Single Sign On password and the service account password if applicable and click **Next**.
- Step 8** After the pre-upgrade checks are complete, accept the default ports and click **Next**.
- Step 9** Check the box to verify that you have backed up this vCenter Server and its database and click **Upgrade**.
- Step 10** Click **Finish**.
-

What to Do Next

Complete the steps in [Upgrading the vSphere Client](#), on page 106.

Upgrading the vSphere Client

Procedure

- Step 1** Run the vSphere Client installer.
- Start the vCenter Server installer. Double-click the **autorun.exe** file and select **vSphere Client**.
 - If you downloaded the vSphere Client, double-click the **VMware-viclient-build number.exe** file.
- Step 2** Click **Next**.
- Step 3** Accept the terms in the license agreements and click **Next**.
- Step 4** Click **Next**.
- Step 5** Click **Install**.
- Step 6** Click **Finish** after the installation completes.
-

What to Do Next

Complete the steps in [Upgrading the vCenter Update Manager to Release 6.0](#), on page 107.

Upgrading the vCenter Update Manager to Release 6.0

Before You Begin

You have upgraded the vCenter Server to the vSphere Client to a compatible version.

Procedure

- Step 1** In the VMware vCenter Installer window, select **vCenter Update Manager Server** and check **Use Microsoft SQL Server 2012 Express as the embedded database**.

Note If the Installer window is not open, run the autorun.exe file.

- Step 2** Click **Install**.
- Step 3** Choose a language and click **OK**. The vCenter Update Manager Installer appears.
- Step 4** Click **OK**.
- Step 5** Click **Next** to begin the upgrade.
- Step 6** View the patent agreement and click **Next**.
- Step 7** Click the **I agree to the terms in the license agreement** radio button and click **Next**.
- Step 8** Verify the IP address and username in the VMware vCenter Server Information area .
- Step 9** In the Password field, enter your password and click **Next**.
- Step 10** Click **Next**.
- Step 11** Click the **Yes, I want to upgrade my Update Manager database** radio button and click **Next**.
- Step 12** Verify the Update Manager port settings and click **Next**.
- Step 13** Verify the proxy settings and click **Next**.
- Step 14** Click **Install** to begin the database upgrade.
- Step 15** Click **OK** to acknowledge that a reboot will be required to complete the setup. During the upgrade, the vSphere Client is disconnected.
- Step 16** Click **Cancel** for the attempt to reconnect.
- Step 17** Click **OK** in the Server Connection Invalid window.
- Step 18** Click **Finish**.
- Step 19** Reboot the vCenter Update Manager and vCenter Server.
- Step 20** Select **Other (Planned)** from the Option drop-down list in the Shut Down Windows dialog box and enter a value in the comment field.
- Step 21** Click **OK**.
- Step 22** After the system reboots, navigate to the C:\ProgramData\VMware Update Manager\Logs\ folder and open the vmware-vum-server-log4cpp file.
- Step 23** Choose **Manage Plug-ins** from the VMware vCenter Server's Plug-in menu.
- Step 24** Click **Download and Install for VMware vSphere Update Manager Extension** under Available Plug-ins..
-

What to Do Next

Complete the steps in [Creating a Customized Upgrade ISO with a VMware ESX Image and a Cisco Nexus 1000V VEM Image](#), on page 108.

Creating a Customized Upgrade ISO with a VMware ESX Image and a Cisco Nexus 1000V VEM Image

Before You Begin

- Install the VMware PowerCLI on a Windows platform. For more information, see the *vSphere PowerCLI Installation Guide*.
- On the same Windows platform, where the VMware PowerCLI is installed, do one of the following:
 - Download the ESX depot, which is a .zip file, to a local file path.

- Download the VEM offline bundle, which is a .zip file, to a local file path.

Procedure

-
- Step 1** Start the VMWare PowerCLI application.
- Step 2** Run the **Set-ExecutionPolicy unrestricted** command.
- Step 3** Connect to the vCenter Server by using the **Connect-VIServer** *IP_address* -User Administrator -Password *password_name* command.
- Step 4** Load the ESXi depot by using the **Add-ESXSoftwareDepot** *path_name*\file_name command.
- Step 5** Display the image profiles by using the **Get-ESXImageProfile** command.
- Step 6** Clone the ESX standard image profile by using the **New-ESXImageProfile -CloneProfile** *ESXImageProfile_name* -Name *clone_profile* command.
- Note** The image profiles are usually in READ-ONLY format. You must clone the image profile before adding the VEM image to it.
- Step 7** Load the Cisco Nexus 1000V VEM offline bundle by using the **Add-ESXSoftwareDepot** *VEM_offline_bundle* command.
- Step 8** Confirm that the n1kv-vib package is loaded by using the **Get-ESXSoftwarePackage -Name** *package_name* command.
- Step 9** Bundle the n1kv-package into the cloned image profile by using the **Add-ESXSoftwarePackage -ImageProfile** *n1kv-Image* -SoftwarePackage *cloned_image_profile* command.
- Step 10** Verify that the Cisco VIB is present by listing all the VIBs in the cloned image profile by entering the following commands.
- \$img = Get-ESXImageProfile** *n1kv-Image*
 - \$img.vibList**
- Verify that the Cisco VIB is present by listing all the VIBs in the cloned image profile.
- Step 11** Export the image profile to an ISO file by using the **Export-ESXImageProfile -ImageProfile** *n1kv-Image* -FilePath *iso_filepath* command.
-

This example shows how to create an upgrade ISO with a VMware ESX image and a Cisco VEM image.



Note The example may contain Cisco Nexus 1000V versions and filenames that are not relevant to your release. Refer to the *Cisco Nexus 1000V and VMware Compatibility Information* for your specific versions and filenames.

```
vSphere PowerCLI> Connect-VIServer 10.105.231.40 -User administrator -Password 'XXXXXXXXX'
```

Working with multiple default servers?

Select [Y] if you want to work with more than one default servers. In this case, every time when you connect to a different server using Connect-VIServer, the new server connection is stored in an array variable together with the previously connected servers. When you run a cmdlet and the target servers cannot be determined from the specified parameters, the cmdlet runs against all servers stored in the array variable.

Select [N] if you want to work with a single default server. In this case,

when you run a cmdlet and the target servers cannot be determined from the specified parameters, the cmdlet runs against the last connected server.

WARNING: WORKING WITH MULTIPLE DEFAULT SERVERS WILL BE ENABLED BY DEFAULT IN A FUTURE RELEASE. You can explicitly set your own preference at any time by using the DefaultServerMode parameter of Set-PowerCLIConfiguration.

[Y] Yes [N] No [S] Suspend [?] Help (default is "Y"): Y

Name	Port	User
-----	-----	-----
10.105.231.40	443	administrator

```
vSphere PowerCLI> Add-EsxSoftwareDepot 'C:\Documents and Settings\Administrator\Desktop\upgrade\229\VEM550-201607300113-BG-release.zip'
```

```
Depot Url
-----
zip:C:\Documents and Settings\Administrator\Desktop\upgrade\229\VMware-ESXi-...
```

```
vSphere PowerCLI> Get-EsxImageProfile
```

Name	Vendor	Last Modified	Acceptance Level
-----	-----	-----	-----
ESXi-5.1.0-20121201001s-no-... CN1-CY	VMware, Inc.	02/02/2016 7:...	PartnerSupported
ESXi-5.1.0-20121204001-stan...	CISCO	4/22/2015 11:...	PartnerSupported
ESXi-5.1.0-20121201001s-sta...	VMware, Inc.	12/7/2015 7:...	PartnerSupported
ESXi-5.1.0-20121201001s-sta...	VMware, Inc.	12/7/2015 7:...	PartnerSupported
ESXi-5.1.0-799733-no-tools	VMware, Inc.	8/2/2015 3:0...	PartnerSupported
ESXi-5.1.0-20121204001-no-t...	VMware, Inc.	12/7/2015 7:...	PartnerSupported
ESXi-5.1.0-799733-standard	VMware, Inc.	8/2/2015 3:0...	PartnerSupported

```
vSphere PowerCLI> New-EsxImageProfile -CloneProfile VEM550-201607300113-BG-release.zip ESXi-5.1.0-799733-standard -Name ESXi-N1Kv-bundle
```

```
cmdlet New-EsxImageProfile at command pipeline position 1
Supply values for the following parameters:
(Type !? for Help.)
Vendor: CISCO
```

Name	Vendor	Last Modified	Acceptance Level
-----	-----	-----	-----
ESXi-N1Kv-bundle	CISCO	02/02/2016 3:0...	PartnerSupported

```
vSphere PowerCLI> Add-EsxSoftwareDepot 'C:\Documents and Settings\Administrator\Desktop\upgrade\229\
\VEM510-201607300107-BG-release.zip'
```

```
Depot Url
-----
zip:C:\Documents and Settings\Administrator\Desktop\upgrade\229\cisco-vem-v1...
```

```
vSphere PowerCLI> Get-EsxSoftwarePackage cisco*
```

Name	Version	Vendor	Creation Date
-----	-----	-----	-----
cisco-vem-v300-esx	5.2.1.3.2.1.0-3.2.1	Cisco Partner Supported	2016-02-02

```
vSphere PowerCLI> Add-EsxSoftwarePackage -SoftwarePackage cisco-vem-v170-esx -ImageProfile ESXi-N1Kv-bundle
```

Name	Vendor	Last Modified	Acceptance Level
-----	-----	-----	-----
ESXi-N1Kv-bundle	CISCO	02/02/2016 3:...	PartnerSupported

```
vSphere PowerCLI> $img = Get-EsxImageProfile ESXi-N1Kv-bundle
```

```
vSphere PowerCLI> $img.vibList
```

Name	Version	Vendor	Creation Date
-----	-----	-----	-----

```

-----
scsi-bnx2i 1.9.1d.v50.1-5vmw.510.0.0.7... VMware 8/2/2012 ...
sata-sata-promise 2.12-3vmw.510.0.0.799733 VMware 8/2/2012 ...
net-forcedeth 0.61-2vmw.510.0.0.799733 VMware 8/2/2012 ...
esx-xserver 5.1.0-0.0.799733 VMware 8/2/2012 ...
misc-cnric-register 1.1-1vmw.510.0.0.799733 VMware 8/2/2012 ...
net-tg3 3.110h.v50.4-4vmw.510.0.0.7... VMware 8/2/2012 ...
scsi-megaraid-sas 5.34-4vmw.510.0.0.799733 VMware 8/2/2012 ...
scsi-megaraid-mbox 2.20.5.1-6vmw.510.0.0.799733 VMware 8/2/2012 ...
scsi-ips 7.12.05-4vmw.510.0.0.799733 VMware 8/2/2012 ...
net-e1000e 1.1.2-3vmw.510.0.0.799733 VMware 8/2/2012 ...
sata-ahci 3.0-13vmw.510.0.0.799733 VMware 8/2/2012 ...
sata-sata-svw 2.3-3vmw.510.0.0.799733 VMware 8/2/2012 ...
net-cnric 1.10.2j.v50.7-3vmw.510.0.0.... VMware 8/2/2012 ...
net-e1000 8.0.3.1-2vmw.510.0.0.799733 VMware 8/2/2012 ...
ata-pata-serverworks 0.4.3-3vmw.510.0.0.799733 VMware 8/2/2012 ...
scsi-mptsapi 4.23.01.00-6vmw.510.0.0.799733 VMware 8/2/2012 ...
ata-pata-hpt3x2n 0.3.4-3vmw.510.0.0.799733 VMware 8/2/2012 ...
net-s2io 2.1.4.13427-3vmw.510.0.0.79... VMware 8/2/2012 ...
esx-base 5.1.0-0.0.799733 VMware 8/2/2012 ...
net-vmxnet3 1.1.3.0-3vmw.510.0.0.799733 VMware 8/2/2012 ...
net-bnx2 215-esx 5.2.1.3.2.1.0-3.1.2 Cisco 2016-11-10
scsi-megaraid2 2.00.4-9vmw.510.0.0.799733 VMware 8/2/2012 ...
ata-pata-amd 0.3.10-3vmw.510.0.0.799733 VMware 8/2/2012 ...
ipmi-ipmi-si-driv 39.1-4vmw.510.0.0.799733 VMware 8/2/2012 ...
scsi-lpfc820 8.2.3.1-127vmw.510.0.0.799733 VMware 8/2/2012 ...
ata-pata-atiixp 0.4.6-4vmw.510.0.0.799733 VMware 8/2/2012 ...
esx-dvfilter-generic-... 5.1.0-0.0.799733 VMware 8/2/2012 ...
net-sky2 1.20-2vmw.510.0.0.799733 VMware 8/2/2012 ...
scsi-qla2xxx 902.k1.1-9vmw.510.0.0.799733 VMware 8/2/2012 ...
net-r8169 6.011.00-2vmw.510.0.0.799733 VMware 8/2/2012 ...
sata-sata-sil 2.3-4vmw.510.0.0.799733 VMware 8/2/2012 ...
scsi-mpt2sas 10.00.00.00-5vmw.510.0.0.79... VMware 8/2/2012 ...
sata-sata-piix 2.12-6vmw.510.0.0.799733 VMware 8/2/2012 ...
scsi-hpsa 5.0.0-21vmw.510.0.0.799733 VMware 8/2/2012 ...
ata-pata-via 0.3.3-2vmw.510.0.0.799733 VMware 8/2/2012 ...
scsi-aacraid 1.1.5.1-9vmw.510.0.0.799733 VMware 8/2/2012 ...
scsi-rste 2.0.2.0088-1vmw.510.0.0.799733 VMware 8/2/2012 ...
ata-pata-cmd64x 0.2.5-3vmw.510.0.0.799733 VMware 8/2/2012 ...
ima-qla4xxx 2.01.31-1vmw.510.0.0.799733 VMware 8/2/2012 ...
net-igb 2.1.11.1-3vmw.510.0.0.799733 VMware 8/2/2012 ...
scsi-qla4xxx 5.01.03.2-4vmw.510.0.0.799733 VMware 8/2/2012 ...
block-cciss 3.6.14-10vmw.510.0.0.799733 VMware 8/2/2012 ...
scsi-aic79xx 3.1-5vmw.510.0.0.799733 VMware 8/2/2012 ...
tools-light 5.1.0-0.0.799733 VMware 8/2/2012 ...
uhci-usb-uhci 1.0-3vmw.510.0.0.799733 VMware 8/2/2012 ...
sata-sata-nv 3.5-4vmw.510.0.0.799733 VMware 8/2/2012 ...
sata-sata-sil24 1.1-1vmw.510.0.0.799733 VMware 8/2/2012 ...
net-ixgbe 3.7.13.6iov-10vmw.510.0.0.7... VMware 8/2/2012 ...
ipmi-ipmi-msghandler 39.1-4vmw.510.0.0.799733 VMware 8/2/2012 ...
scsi-adp94xx 1.0.8.12-6vmw.510.0.0.799733 VMware 8/2/2012 ...
scsi-fnic 1.5.0.3-1vmw.510.0.0.799733 VMware 8/2/2012 ...
ata-pata-pdc2027x 1.0-3vmw.510.0.0.799733 VMware 8/2/2012 ...
misc-drivers 5.1.0-0.0.799733 VMware 8/2/2012 ...
net-enic 1.4.2.15a-1vmw.510.0.0.799733 VMware 8/2/2012 ...
net-be2net 4.1.255.11-1vmw.510.0.0.799733 VMware 8/2/2012 ...
net-nx-nic 4.0.558-3vmw.510.0.0.799733 VMware 8/2/2012 ...
esx-xlibs 5.1.0-0.0.799733 VMware 8/2/2012 ...
net-bnx2x 1.61.15.v50.3-1vmw.510.0.0.... VMware 8/2/2012 ...
ehci-ehci-hcd 1.0-3vmw.510.0.0.799733 VMware 8/2/2012 ...
ohci-usb-ohci 1.0-3vmw.510.0.0.799733 VMware 8/2/2012 ...
net-r8168 8.013.00-3vmw.510.0.0.799733 VMware 8/2/2012 ...
esx-tboot 5.1.0-0.0.799733 VMware 8/2/2012 ...
ata-pata-sil680 0.4.8-3vmw.510.0.0.799733 VMware 8/2/2012 ...
ipmi-ipmi-devintf 39.1-4vmw.510.0.0.799733 VMware 8/2/2012 ...
scsi-mptsas 4.23.01.00-6vmw.510.0.0.799733 VMware 8/2/2012 ...

```

```

vSphere PowerCLI> Export-ESXImageProfile -ImageProfile ESXi-N1Kv-bundle -FilePath
'C:\Documents and Settings\Administrator\Desktop\ESXi-N1Kv-bundle.iso' -ExportToIso

```

Installing VMware Release 5.x and 6.x Patches

Creating the Host Patch Baseline for 5.x or 6.x Patches

Before You Begin

- VMware release 5.x or 6.x must be installed prior to installing a patch.
- Ensure you configure the VMware Update Manager Download settings with proxy enabled and VMware production portal links for VMware ESX/ESXi in connected state and download those images into the VUM patch repository.



Note Do not install VMware vSphere 5.5 Patch 2702864 with Cisco Nexus 1000V. The VMware vSphere 5.5 Patch 2702864 is not supported on Cisco Nexus 1000V.

Procedure

-
- Step 1** Under **Home > Solutions and Applications > Update Manager**, select **Baselines and Groups** tab.
- Step 2** Under **Baseline**, click **Create** to create a baseline.
- Step 3** In the **Baseline Name and Type** window, enter a name for the baseline, select the **Host Patch** radio button and click **Next**.
- Step 4** In the **Patch Options** window, select the **Fixed** radio button and click **Next**.
- Step 5** In the **Patches** window, select the required patch to upgrade to and move the selected patch to **Fixed patches to Add** column and click **Next**.
- Note** To find the 6.x or 5.1 update 1 and later patches, refer to <http://www.vmware.com/patchmgr/findPatch.portal>.
- Note** In the combined upgrade scenario, add the required Cisco Nexus 1000V VEM patch that corresponds to 6.x and 5.x releases to the **Fixed patches to Add** column along with ESXi 6.x and 5.x patches. You can get the required Cisco Nexus 1000V VEM patches into the VUM patch repository either from www.cisco.com, VMWare production portal links or through the VSM home page.
-

Upgrading the ESXi Hosts to Release 5.x or 6.x Patches Using VMware Update Manager



Note Follow the same procedure to upgrade ESXi hosts 5.0 to 5.0 Update 1 and later.

Procedure

-
- Step 1** In the vSphere Client, choose **Home > Hosts and Clusters** .
- Step 2** From the left navigation pane, select the host or cluster that needs to be upgraded and click **Update Manager**.
- Step 3** Click **Attach**.
- Step 4** In the Individual Baselines by Type area, select your Patch baseline's radio button check box.
- Step 5** Click **Attach**.
- Step 6** Click **Scan**.
- Step 7** In the Confirm Scan dialog box, check the **Patches and extensions box** and click **Scan**. Verify if all the hosts are non-compliant.
- Step 8** Click **Stage**.
- Step 9** In Baseline Selection window, keep the default selected baseline and click **Next**.
- Step 10** In Patch and Extension exclusion window, keep the default selected baseline and click **Next**.
- Step 11** Click **Finish**.
- Step 12** Click **Remediate** and click **Next**.
- Step 13** In Patch and Extension exclusion window, keep the default selected baseline and click **Next**.
- Step 14** Click **Next**.
- Step 15** In the Host Remediate Options window, under Maintenance Mode Options, select the **Disable any removable media devices connected to the virtual machines on the host** check box.
- Note** If you have stateless host in your setup, select **Enable Patch Remediation on Powered on PXE booted ESXi hosts** radio button.
- Step 16** Click **Next**.
- Step 17** In the Cluster Remediation Options window, select all the check boxes and click **Next**.
- Step 18** Click **Finish** to begin the remediation.
- To check the host versions, on the left-hand pane, click on each host to confirm if version 6.x and 5.x appears in the top-left corner of the right-hand pane and the version information matches the information provided under the *Cisco Nexus 1000V and VMware Compatibility Information* guide.
- You can also confirm if the upgrade was successful by executing the **show module** command on the VSM and check if the VEMs are running the correct build.
-

Upgrading the ESXi Hosts to Release 5.x or 6.x Using the CLI

You can upgrade an ESXi host by installing a VMware patch or update with the compatible Cisco Nexus 1000V VEM software.



Note

Do not install VMware vSphere 5.5 Patch 2702864 with Cisco Nexus 1000V. The VMware vSphere 5.5 Patch 2702864 is not supported on Cisco Nexus 1000V.

Before You Begin

- You have downloaded and installed the VMware vCLI. For information about installing the vCLI, see the VMware vCLI documentation.
- You are logged in to the remote host when the vCLI is installed.



Note

The vSphere Command-Line Interface (vSphere CLI) command set allows you to enter common system administration commands against ESXi systems from any machine with network access to those systems. You can also enter most vSphere CLI commands against a vCenter Server system and target any ESXi system that the vCenter Server system manages. vSphere CLI commands are especially useful for ESXi hosts because ESXi does not include a service console.

- If you are using the `esxupdate` command, you are logged into the ESX host.
- Check the *Cisco Nexus 1000V and VMware Compatibility Information* for compatible versions.
- You have already copied the ESXi host software and VEM software installation file to the `/tmp` directory.
- You know the name of the ESXi and VEM software file to be installed.

Procedure

Step 1 Download the VEM software and copy them to the local host.

Step 2 Determine the upgrade method that you want to use.

If you are using the vCLI, enter the `esxcli` command and install the ESXi and VEM software simultaneously.

esxcli software vib install -v *full-path-to-vib*

Note When using the `esxcli software VIB install` command, you must log in to each host and enter the command. ESXi expects the VIB to be in the `/var/log/vmware` directory if the absolute path is not specified.

```
# esxcli software vib update -d /var/tmp/update-from-esxi5.1-5.1_update01.zip
Installation Result
  Message: The update completed successfully, but the system needs to be rebooted for the
  changes to be effective.
  Reboot Required: true
  VIBs Installed: VMware_bootbank_esx-base_5.1.0-0.12.1065491,
  VMware_locker_tools-light_5.1.0-0.12.1065491
  VIBs Removed: VMware_bootbank_esx-base_5.1.0-0.3.799733,
  VMware_locker_tools-light_5.0.0-0.0.799733
  VIBs Skipped: VMware_bootbank_ata-pata-amd_0.3.10-3vmw.510.0. 3.799733,
  VMware_bootbank_ata-pata-atiixp_0.4.6-3vmw.510.0. 3.799733,
  VMware_bootbank_scsi-qla4xxx_5.01.03.2-3vmw.510.0.3.799733.,
  VMware_bootbank_uhci-usb-uhci_1.0-3vmw.510.0.3.799733
```

Upgrading the VMware DVS Version Using the VSM CLI

You can upgrade the VMware DVS version from the current version (4.0 or 5.0) to 5.0 and above using the VSM commands.

Before You Begin

- You have upgraded the VSM to the current Cisco Nexus 1000V release.



Note

The VMware ESXi host should be compatible with the new DVS version. Supported DVS versions are 5.0.0, 5.1.0, 5.5.0 or 6.0.0. If the ESXi host is incompatible with the new DVS version, the upgrade process fails.

Procedure

- Step 1** Log in to **svs-connection** command mode in the VSM.
- Step 2** Configure the DVS version using **vmware dvs-version version_no** command.
- ```
vsm(config-svs-conn)#
vsm(config-svs-conn)# vmware dvs-version 5.1.0
```
- Step 3** Verify the DVS version upgrade using **show svs connections** command.
- ```
vsm(config-svs-conn)# show svs connections
```

```
connection nlk-vc:
  hostname: -
  ip address: 103.3.176.26
  ipv6 address: -
  remote port: 80
  transport type: ipv4
  protocol: vmware-vim https
  certificate: default
  datacenter name: dc-tb22
  admin:
  max-ports: 12000
  DVS uuid: a4 a7 0f 50 c8 79 ba a2-85 86 75 fd 53 7f d9 25
  dvs version: 5.1.0
  config status: Enabled
  operational status: Connected
  sync status: Complete
  version: VMware vCenter Server 6.0.0 build-2559268
  vc-uuid: 4fd42386-8cba-4055-8872-6340e2f61d86
  ssl-cert: self-signed or not authenticated
```

Verifying the Build Number and Upgrade



Note The examples in the procedure may contain Cisco Nexus 1000V versions and filenames that are not relevant to your release. Refer to the *Cisco Nexus 1000V and VMware Compatibility Information* for your specific versions and filenames.

Before You Begin

- You have upgraded the VSMs and VEMs to the current Cisco Nexus 1000V release.



Note The VSM upgrade will not proceed if ESX/ESXi 4.0 or 4.1 is part of the DVS. You must either remove ESX 4.0 or 4.1 from the DVS and proceed with VSM upgrade or upgrade ESX 4.0 or 4.1 to 5.0 or later releases and proceed with the VSM upgrade.

- You have upgraded the vCenter Server.
- You have upgraded the VMware Update Manager.
- You have upgraded your ESX/ESXi hosts.

Procedure

Step 1 Verify the build number on the ESXi host.

```
~ # vmware -v -l
VMware ESXi 5.5.0 build-2068190
VMware ESXi 5.5.0 Update 2
~ #
```

Step 2 Verify the VIB installed

```
~ # esxcli software vib list |grep cisco
cisco-vem-v300-esx          5.2.1.3.2.1.0-3.2.1          Cisco   PartnerSupported
2016-06-30
~ #
```

Step 3 Verify VEM status.

```
~ # vem status -v
Package vssnet-esxesx2013-release
Version 5.2.1.3.2.1.0-3.2.1
Build 1
Date Wed Jun 16:27:37 PST 2016
```

VEM modules are loaded

Switch Name	Num Ports	Used Ports	Configured Ports	MTU	Uplinks
vSwitch0	2432	106	128	1500	vmnic0
DVS Name	Num Ports	Used Ports	Configured Ports	MTU	Uplinks
BL	1024	22	1024	1500	vmnic5,vmnic4,vmnic7

VEM Agent (vemdpa) is running

```
~ #
```

Step 4 Verify VEM version.

```
~ # vemcmd show version
VEM Version: 5.2.1.3.2.1.0-3.2.1
```

```
VSM Version: 5.2(1)SV3(2.1)
System Version: VMware ESXi 5.5.0 Releasebuild-2068190
ESX Version Update Level: 2
~ #
```

Step 5 Verify the upgrade on the Cisco Nexus 1000V VSM.

```
switch# show module
```

```
switch# sh module
Mod  Ports  Module-Type                Model                Status
----  -
1    0       Virtual Supervisor Module  Nexus1000V          ha-standby
2    0       Virtual Supervisor Module  Nexus1000V          active *
3    1022   Virtual Ethernet Module    NA                   ok
4    1022   Virtual Ethernet Module    NA                   ok
5    1022   Virtual Ethernet Module    NA                   ok
6    1022   Virtual Ethernet Module    NA                   ok
7    1022   Virtual Ethernet Module    NA                   ok
```

```
Mod  Sw                Hw
----  -
1    5.2(1)SV3(2.1)   0.0
2    5.2(1)SV3(2.1)   0.0
3    5.2(1)SV3(2.1)   VMware ESXi 5.1.0 Releasebuild-2323236 (3.1)
4    5.2(1)SV3(2.1)   VMware ESXi 5.1.0 Releasebuild-2323236 (3.1)
5    5.2(1)SV3(2.1)   VMware ESXi 6.0.0 Releasebuild-3620759 (6.0)
6    5.2(1)SV3(2.1)   VMware ESXi 5.5.0 Releasebuild-2068190 (3.2)
7    5.2(1)SV3(2.1)   VMware ESXi 6.0.0 Releasebuild-3620759 (6.0)
```

```
Mod  Server-IP          Server-UUID          Server-Name
----  -
1    10.197.133.101    NA                   NA
2    10.197.133.101    NA                   NA
3    10.197.132.44     7b1a5e63-bcd0-11e0-bd1d-30e4dbc2c3ae  NA
4    10.197.132.42     e0829a21-bc61-11e0-bd1d-30e4dbc2ba66  NA
5    10.197.132.43     e6c1a563-bc9e-11e0-bd1d-30e4dbc2baba  NA
6    10.197.132.46     db8b80ac-af1d-11e0-a4e7-30e4dbc26b82  NA
7    10.197.132.45     8d8ff0e8-b565-11e0-bd1d-30e4dbc297da  NA
```

```
* this terminal session
```

