



Cisco Enterprise Network Function Virtualization Infrastructure Software Configuration Guide, Release 3.8.x

First Published: 2017-12-15

Last Modified: 2018-04-20

Americas Headquarters

Cisco Systems, Inc.
170 West Tasman Drive
San Jose, CA 95134-1706
USA
<http://www.cisco.com>
Tel: 408 526-4000
800 553-NETS (6387)
Fax: 408 527-0883

THE SPECIFICATIONS AND INFORMATION REGARDING THE PRODUCTS IN THIS MANUAL ARE SUBJECT TO CHANGE WITHOUT NOTICE. ALL STATEMENTS, INFORMATION, AND RECOMMENDATIONS IN THIS MANUAL ARE BELIEVED TO BE ACCURATE BUT ARE PRESENTED WITHOUT WARRANTY OF ANY KIND, EXPRESS OR IMPLIED. USERS MUST TAKE FULL RESPONSIBILITY FOR THEIR APPLICATION OF ANY PRODUCTS.

THE SOFTWARE LICENSE AND LIMITED WARRANTY FOR THE ACCOMPANYING PRODUCT ARE SET FORTH IN THE INFORMATION PACKET THAT SHIPPED WITH THE PRODUCT AND ARE INCORPORATED HEREIN BY THIS REFERENCE. IF YOU ARE UNABLE TO LOCATE THE SOFTWARE LICENSE OR LIMITED WARRANTY, CONTACT YOUR CISCO REPRESENTATIVE FOR A COPY.

The Cisco implementation of TCP header compression is an adaptation of a program developed by the University of California, Berkeley (UCB) as part of UCB's public domain version of the UNIX operating system. All rights reserved. Copyright © 1981, Regents of the University of California.

NOTWITHSTANDING ANY OTHER WARRANTY HEREIN, ALL DOCUMENT FILES AND SOFTWARE OF THESE SUPPLIERS ARE PROVIDED "AS IS" WITH ALL FAULTS. CISCO AND THE ABOVE-NAMED SUPPLIERS DISCLAIM ALL WARRANTIES, EXPRESSED OR IMPLIED, INCLUDING, WITHOUT LIMITATION, THOSE OF MERCHANTABILITY, FITNESS FOR A PARTICULAR PURPOSE AND NON-INFRINGEMENT OR ARISING FROM A COURSE OF DEALING, USAGE, OR TRADE PRACTICE.

IN NO EVENT SHALL CISCO OR ITS SUPPLIERS BE LIABLE FOR ANY INDIRECT, SPECIAL, CONSEQUENTIAL, OR INCIDENTAL DAMAGES, INCLUDING, WITHOUT LIMITATION, LOST PROFITS OR LOSS OR DAMAGE TO DATA ARISING OUT OF THE USE OR INABILITY TO USE THIS MANUAL, EVEN IF CISCO OR ITS SUPPLIERS HAVE BEEN ADVISED OF THE POSSIBILITY OF SUCH DAMAGES.

Any Internet Protocol (IP) addresses and phone numbers used in this document are not intended to be actual addresses and phone numbers. Any examples, command display output, network topology diagrams, and other figures included in the document are shown for illustrative purposes only. Any use of actual IP addresses or phone numbers in illustrative content is unintentional and coincidental.

All printed copies and duplicate soft copies of this document are considered uncontrolled. See the current online version for the latest version.

Cisco has more than 200 offices worldwide. Addresses and phone numbers are listed on the Cisco website at www.cisco.com/go/offices.

Cisco and the Cisco logo are trademarks or registered trademarks of Cisco and/or its affiliates in the U.S. and other countries. To view a list of Cisco trademarks, go to this URL: [www.cisco.com go trademarks](http://www.cisco.com/go/trademarks). Third-party trademarks mentioned are the property of their respective owners. The use of the word partner does not imply a partnership relationship between Cisco and any other company. (1721R)

© 2017–2018 Cisco Systems, Inc. All rights reserved.



CONTENTS

Full Cisco Trademarks with Software License ?

PREFACE

Preface ix

Preface ix

Audience ix

Related Documentation ix

Communications, Services, and Additional Information x

CHAPTER 1

About Cisco Enterprise NFVIS 1

Benefits of Cisco Enterprise NFVIS 1

Supported Hardware Platforms 2

Key Tasks You can Perform Using Cisco Enterprise NFVIS 3

CHAPTER 2

Installing Cisco Enterprise NFVIS Using the KVM Console 5

Installation Prerequisites 5

Image Signing and Verification 6

RPM Signing 6

RPM Signature Verification 6

Image Integrity Verification Using sha256sum 6

Entering BIOS Setup 7

Installing Cisco Enterprise NFVIS on the Cisco UCS C220 M4 Rack Server or Cisco CSP 2100 7

Logging Into the CIMC GUI 7

Activating a Virtual Device 8

Mapping the Cisco Enterprise NFVIS Image 8

Installing Cisco Enterprise NFVIS on Cisco UCS E-Series Servers 8

Sample Configuration on the Cisco ISR Router to Bring Up a Cisco UCS E Server 10

Installing Cisco Enterprise NFVIS on a Cisco ENCS 5100 and 5400	12
Installing Cisco Enterprise NFVIS on a Cisco ENCS 5104	13

CHAPTER 3**Setting Up System Configuration 17**

Default System Configuration on the Cisco ENCS	17
Default System Configuration on the Cisco UCS C220 M4 Server and Cisco CSP 2100	19
Default System Configuration on the Cisco UCS E-Series Servers	20
Setting Up Initial Configuration	20
Configuring VLAN for NFVIS Management Traffic	26
Configuring System Routes	27
User Roles and Authentication	28
Rules for User Passwords	28
Creating Users and Assigning Roles	29
Configuring Minimum Length for Passwords	29
Configuring Password Lifetime	30
Deactivating Inactive User Accounts	30
Activating an Inactive User Account	31
Certification	31
Secure Copy Command	32
Configuring the IP Receive ACL	32
Port 22222 and Management Interface ACL	33
Configuring Your Banner and Message of the Day	33
Setting the System Time Manually or With NTP	34
Enabling or Disabling the Portal Access	35
Configuring System Logs	36
Network File System Support	37
Secure Boot of host	38
CIMC Control	39
CIMC Access using NFVIS	39
BIOS-CIMC Update	40
NFVIS Password Recovery	40
DPDK Support on NFVIS	40
DPDK Support for NFVIS 3.10.x	40
DPDK VM Migration for NFVIS 3.11.x	41

	Enhancements to DPDK Support in NFVIS 3.12.x	41
	Import and Export NFVIS VM	44
	Backup and Restore NFVIS and VM Configurations	45
	Dynamic SR-IOV	47
<hr/>		
CHAPTER 4	Cisco Network Plug-n-Play Support	49
	PnP Discovery Methods	50
	Configuring PnP Discovery Methods	51
	PnP Action	54
<hr/>		
CHAPTER 5	VM Life Cycle Management	55
	Workflow of VM Life Cycle Management	55
	Uploading VM Images to an NFVIS Server	57
	VM Bootstrap Configuration Options with a VM Deployment	58
	OpenStack Configuration Drive Support for Third Party VMs	59
	Performing Resource Verification	60
	Configuring Management IP Address	61
	VM States	61
<hr/>		
CHAPTER 6	VM Deployment Scenarios	63
	Registering VM Images	63
	Single VM Deployment	64
	Steps for Deploying a VM	64
	Service Chaining of VMs	67
	Service Chaining with two VM Images	67
	Steps for Service Chaining with Two VM Images	67
	Service Chaining of Multiple VMs with Windows or Linux Servers	68
	Steps for Service Chaining of Multiple VMs with Windows or Linux Servers	68
<hr/>		
CHAPTER 7	SPAN Session or Port Mirroring	69
	About SPAN Sessions	69
	Configuring SPAN Sessions	69
	Configuration Examples for SPAN Session Scenarios	71
	Example: SPAN Session Traffic on a Physical Interface	71

Example: SPAN Session Traffic on a LAN SRIOV 72

Example: SPAN Session Traffic on a VLAN 73

CHAPTER 8 **Configuring Packet Capture 75**

CHAPTER 9 **VM Image Packaging 77**

VM Image Packaging Utility 77

 Contents 77

 Usage 78

 NFVIS Specific Enhancements 82

 VM Packaging Utility Usage Examples 83

Standard VM Image Packaging 84

 Generating a VM Package 85

Appendix 85

 VM Image Package Files 85

 Package Manifest File 86

 Bootstrap Configuration File 86

 VM Image Properties File 87

 Example: Package.mf 91

 Example: Image Properties 92

 Example: Bootstrap Configuration File 93

 Image Properties Template File 93

CHAPTER 10 **Upgrading Cisco Enterprise NFVIS 95**

CHAPTER 11 **Configuring vBranch High Availability 99**

Prerequisites for vBranch HA 99

vBranch HA Design and Topology 100

Enable Virtual NIC Failure Detection with Track Feature 101

Isolating LAN and Transit Link Traffic for vBranch HA 103

Packet Flow for vBranch HA 104

Configuration Examples for vBranch HA 105

 Example: Active Cisco ENCS Configuration with ISRV1 105

 Example: Standby Cisco ENCS Configuration with ISRV2 107

	Cisco ENCS Failure Points	108
<hr/>		
CHAPTER 12	Cisco ENCS Single WAN IP Deployment Scenarios	113
	Single WAN IP Deployment	113
	Preconfiguring the Cisco ENCS for a Single WAN IP Deployment	114
	Single WAN IP Deployment with Gigabit Ethernet Interface 0/0	115
	Single WAN IP Deployment with the 4G Interface	116
<hr/>		
CHAPTER 13	Resetting to Factory Default	119
<hr/>		
CHAPTER 14	Event Notifications	121
	nfvisEvent	122
	vmlcEvent	133
<hr/>		
CHAPTER 15	Syslog Support	151
<hr/>		
CHAPTER 16	SNMP Support on NFVIS	153
	Introduction about SNMP	153
	SNMP Operations	153
	SNMP Get	154
	SNMP Notifications	155
	SNMP Versions	155
	SNMP MIB Support	156
	Configuring SNMP Support	158
<hr/>		
CHAPTER 17	TACACS and RADIUS Support on NFVIS	163
	About RADIUS	163
	RADIUS Operation	163
	Configuring a TACACS+ Server	164
	Configuring RADIUS	165
	Specifying TACACS and RADIUS Authentication	166
<hr/>		
CHAPTER 18	ENCS Switch Configuration	167

ENCS Switch Commands	167
ENCS Switch APIs	167
ENCS Switch Portal Configuration	167
Switch Settings	167
Configuring Spanning Tree	169
Configuring Dot1x	171
Configuring LACP	172
Configuring VLAN	173
Configuring General Settings	174
Configuring Advanced Settings	175
Configuring Spanning Tree per Interface	176

CHAPTER 19 **Configuring Secondary IP and Source Interface** 179

CHAPTER 20 **Ports and Port Channels** 181

Configuring Port Channels	181
Information About Port Channels	181
Port Channels Bond Mode	181
Port Channels LACP Mode	182
Creating a Port Channel	182
Adding a Port to a Port Channel	182
Adding a Port Channel to a Bridge	182
Deleting a Port Channel	183
Removing a Port from a Port Channel	183
Removing a Port Channel from a Bridge	183
Configuring LLDP	184
Configuring Admin Status of a Port	184
Tracking Changes for a Port	185
Speed, Duplex and Autonegotiation	185

CHAPTER 21 **MSTP for ENCS 5400 8-Port Switch** 187



Preface

- [Preface, on page ix](#)
- [Audience, on page ix](#)
- [Related Documentation, on page ix](#)
- [Communications, Services, and Additional Information, on page x](#)

Preface

This guide provides information about how to install and configure Cisco Enterprise Network Function Virtualization Infrastructure Software (Cisco Enterprise NFVIS) on a supported Cisco hardware device. The guide also provides details on virtual machine deployments, configuration of software features, and life cycle management using Representation State Transfer (REST) application programming interface (API).

Audience

This guide is intended for network administrators and operators who are familiar with basic Linux installation and configuration requirements.

Related Documentation

- [API Reference for Cisco Enterprise Network Function Virtualization Infrastructure Software](#)
- [Cisco Enterprise Network Function Virtualization Infrastructure Software Command Reference](#)
- https://www.cisco.com/c/en/us/td/docs/routers/nfvis/release_notes/3-10-1/cisco-enterprise-nfvis-release-notes-3-10-1.html
- [Cisco 5400 Enterprise Network Compute System Hardware Installation Guide](#)
- [Cisco 5400 Enterprise Network Compute System Data Sheet](#)
- [Getting Started Guide for Cisco UCS E-Series Servers and the Cisco UCS E-Series Network Compute Engine](#)
- [Cisco UCS C220 M4 Server Installation and Service Guide](#)
- [Configuration Guide for Cisco Network Plug and Play on Cisco APIC-EM](#)

Communications, Services, and Additional Information

- To receive timely, relevant information from Cisco, sign up at [Cisco Profile Manager](#).
- To get the business impact you're looking for with the technologies that matter, visit [Cisco Services](#).
- To submit a service request, visit [Cisco Support](#).
- To discover and browse secure, validated enterprise-class apps, products, solutions and services, visit [Cisco Marketplace](#).
- To obtain general networking, training, and certification titles, visit [Cisco Press](#).
- To find warranty information for a specific product or product family, access [Cisco Warranty Finder](#).

Cisco Bug Search Tool

[Cisco Bug Search Tool](#) (BST) is a web-based tool that acts as a gateway to the Cisco bug tracking system that maintains a comprehensive list of defects and vulnerabilities in Cisco products and software. BST provides you with detailed defect information about your products and software.



CHAPTER 1

About Cisco Enterprise NFVIS

Cisco Enterprise Network Function Virtualization Infrastructure Software (Cisco Enterprise NFVIS) is a Linux-based infrastructure software designed to help service providers and enterprises to design, deploy and manage network services. Cisco Enterprise NFVIS helps dynamically deploy virtualized network functions, such as a virtual router, firewall, and WAN acceleration, on a supported Cisco device. You do not always require a physical device for every network function. Automated provisioning and centralized management also eliminates costly truck rolls.

Cisco Enterprise NFVIS provides a Linux-based virtualization layer to the Cisco Enterprise Network Function Virtualization (ENFV) solution.

Cisco ENFV Solution Overview

The Cisco ENFV solution helps convert your critical network functions into a software which can deploy network services across dispersed locations in minutes. It provides a fully integrated platform that can run on top of a diverse network of both virtual and physical devices with the following primary components:

- Cisco Enterprise NFVIS
- VNFs
- Unified Computing System (UCS) and Enterprise Network Compute System (ENCS) hardware platforms
- Digital Network Architecture Center (DNAC)

For more details on the Cisco ENFV solution, see the [Cisco Enterprise Network Functions Virtualization Solution Overview](#).

- [Benefits of Cisco Enterprise NFVIS, on page 1](#)
- [Supported Hardware Platforms, on page 2](#)
- [Key Tasks You can Perform Using Cisco Enterprise NFVIS, on page 3](#)

Benefits of Cisco Enterprise NFVIS

- Cost effective solution to consolidate multiple physical network appliances into a single server running multiple virtual network functions.
- Flexibility in deploying services quickly and in a timely manner.
- Cloud based VM life cycle management and provisioning.

- In-box life cycle management software to deploy and chain VMs dynamically on the platform.
- Programmable APIs.

Supported Hardware Platforms

Depending on your requirement, you can install Cisco Enterprise NFVIS on the following Cisco hardware platforms:

- Cisco 5100 Series Enterprise Network Compute System (Cisco ENCS)
- Cisco 5400 Series Enterprise Network Compute System (Cisco ENCS)
- Cisco UCS C220 M4 Rack Server
- Cisco Cloud Services Platform 2100 (CSP 2100)
- Cisco ISR4331 with UCS-E140S-M2/K9
- Cisco ISR4351 with UCS-E160D-M2/K9
- Cisco ISR4451-X with UCS-E180D-M2/K9
- Cisco UCS-E160S-M3/K9 Server
- Cisco UCS-E180D-M3/K9
- Cisco UCS-E1120D-M3/K9

Cisco ENCS

The Cisco 5100 and 5400 Series Enterprise Network Compute System combines routing, switching, storage, processing, and a host of other computing and networking activities into a compact one Rack Unit (RU) box. This high-performance unit achieves this goal by providing the infrastructure to deploy virtualized network functions and acting as a server that addresses processing, workload, and storage challenges.

Cisco UCS C220 M4 Rack Server

The Cisco UCS C220 M4 Rack Server is a high-density, general-purpose enterprise infrastructure and application server that delivers world class performance for a wide range of enterprise workloads, including virtualization, collaboration, and bare-metal applications.

Cisco CSP 2100

Cisco Cloud Services Platform 2100 (Cisco CSP 2100) is a software and hardware platform for data center network functions virtualization. This open kernel virtual machine (KVM) platform, with Red Hat Enterprise Linux (RHEL) 7.3 as the base operating system, is designed to host networking virtual services. Cisco CSP 2100 enables network, security, and load balancer teams to quickly deploy any Cisco or third-party network virtual service.



Note Return Material Authorization (RMA) capability for CSP 2100 is not supported when in use with NFVIS.

Cisco UCS E-Series Server Modules

The Cisco UCS E-Series Servers (E-Series Servers) are the next generation of Cisco UCS Express servers. E-Series Servers are a family of size, weight, and power efficient blade servers that are housed within the Generation 2 Cisco Integrated Services Routers (ISR G2), Cisco 4400, and Cisco 4300 Series Integrated Services Routers. These servers provide a general-purpose compute platform for branch office applications deployed either as bare metal on operating systems, such as Microsoft Windows or Linux; or as virtual machines on hypervisors.

Supported VMs

Currently, the following Cisco supplied VMs and third party VMs are supported:

- Cisco ISRv
- Cisco Adaptive Security Virtual Appliance (ASAv)
- Cisco Virtual Wide Area Application Services (vWAAS)
- Linux Server VM
- Windows Server 2012 VM

Key Tasks You can Perform Using Cisco Enterprise NFVIS

- Perform VM image registration and deployment
- Create new networks and bridges, and assign ports to bridges
- Create custom flavors—a flavor is the customized profile of the VM image
- Perform service chaining of VMs
- Perform VM operations
- Verify system information including CPU, port, memory, and disk statistics

The APIs for performing these tasks are explained in the API Reference for Cisco Enterprise NFVIS.



Note From a Cisco Enterprise NFVIS command-line interface, you can connect to another server and VMs remotely using the SSH client.



CHAPTER 2

Installing Cisco Enterprise NFVIS Using the KVM Console

- [Installation Prerequisites](#) , on page 5
- [Image Signing and Verification](#), on page 6
- [Entering BIOS Setup](#), on page 7
- [Installing Cisco Enterprise NFVIS on the Cisco UCS C220 M4 Rack Server or Cisco CSP 2100](#), on page 7
- [Installing Cisco Enterprise NFVIS on Cisco UCS E-Series Servers](#), on page 8
- [Installing Cisco Enterprise NFVIS on a Cisco ENCS 5100 and 5400](#), on page 12

Installation Prerequisites

Ensure that the following prerequisites are met:

- The IP address is configured for Cisco Integrated Management Controller (CIMC) as well as a login account with administrative privileges.
- The login account is set up with administrative privileges.
- The installation media for Cisco Enterprise NFVIS has an ISO image.
- The IP address of the system (required for remote access) is available.
- Hyper-threading is enabled in BIOS. By default, hyper-threading is enabled in BIOS on the UCS-C, UCS-E and ENCS platforms.



Note The installation steps are slightly different for Cisco UCS and Cisco ENCS platforms. See the following sections for details:

[Installing Cisco Enterprise NFVIS on the Cisco UCS C220 M4 Rack Server or Cisco CSP 2100](#), on page 7

[Installing Cisco Enterprise NFVIS on Cisco UCS E-Series Servers](#), on page 8

[Installing Cisco Enterprise NFVIS on a Cisco ENCS 5100 and 5400](#), on page 12

Assumptions

- The user is familiar with the supported hardware device, CIMC, Cisco Network Plug and Play, and Cisco Application Policy Infrastructure Controller Enterprise Module (APIC-EM).
- The initial setup of the hardware device is complete, and the device is ready for loading Cisco Enterprise NFVIS.
- The user is familiar with general Linux installation.

For more details on the supported hardware devices, see respective documentation available on Cisco.com.

Image Signing and Verification

Cisco Enterprise NFVIS supports RPM signing and signature verification for all RPM packages in the ISO and upgrade images. You can also verify the integrity of the Cisco Enterprise NFVIS ISO and upgrade images.

RPM Signing

All RPM packages in the Cisco Enterprise NFVIS ISO and upgrade images are signed to ensure cryptographic integrity and authenticity. This guarantees that the RPM packages have not been tampered with and the RPM packages are from Cisco Enterprise NFVIS. The private key, used for signing the RPM packages, is created and securely maintained by Cisco.

RPM Signature Verification

Cisco Enterprise NFVIS verifies all RPM packages during installation or upgrade. The following table describes the Cisco Enterprise NFVIS behavior when the signature verification fails during installation or upgrade.

Scenario	Description
Cisco Enterprise NFVIS 3.7.1 installation	If the signature verification fails while installing Cisco Enterprise NFVIS, the installation is aborted.
Cisco Enterprise NFVIS upgrade from 3.6.x to Release 3.7.1	The RPM signatures are verified when the upgrade is being performed. If the signature verification fails, an error is logged but the upgrade is completed.
Cisco Enterprise NFVIS upgrade from Release 3.7.1 to later releases	The RPM signatures are verified when the upgrade image is registered. If the signature verification fails, the upgrade is aborted.

Image Integrity Verification Using sha256sum

RPM signing and signature verification can be done only for the RPM packages available in the Cisco NFVIS ISO and upgrade images. To ensure the integrity of all additional non-RPM files available in the Cisco NFVIS ISO image, a hash of the Cisco NFVIS ISO image is published along with the image. Similarly, a hash of the Cisco NFVIS upgrade image is published along with the image. To verify that the hash of Cisco NFVIS ISO image or upgrade image matches the hash published by Cisco, run the following command and compare the hash with the published hash:

```
% /usr/bin/sha256sum ImageFile
4db533d96d8705db8af904ab754349151adea504b81337155cc591c6203e3295 ImageFile
```

Entering BIOS Setup



Note This section applies only to ENCS 5400 and UCS-E series routers.

When you enter the BIOS setup for the first time, ensure that you secure the BIOS by setting up an admin-level and a user-level password. You have to set up the admin password when you access the BIOS menu for the first time. The user password (which only gives access to a small subset of BIOS options) must be set inside the BIOS setup menu.

To set up the admin password, press F2 when the system boots up. You will be prompted to set the password.

To set up the user password, after you log in, go to the 'Security' tab and set the password.

Installing Cisco Enterprise NFVIS on the Cisco UCS C220 M4 Rack Server or Cisco CSP 2100

This section provides information about a series of tasks you need to perform to install Cisco Enterprise NFVIS on a Cisco UCS C220 M4 Rack Server or Cisco CSP 2100.

Logging Into the CIMC GUI

Before you begin

- Make sure that you have configured the IP address to access CIMC.
- If not installed, install Adobe Flash Player 10 or later on your local system.

For details on how to configure an IP address for CIMC, see the [Set up CIMC for UCS C-Series Server](#) guide on cisco.com.

Step 1 In your web browser, enter the IP address that you configured to access CIMC during initial setup.

Step 2 If a security dialog box displays, do the following:

- a) **Optional:** Select the check box to accept all content from Cisco.
- b) Click **Yes** to accept the certificate and continue.

Step 3 In the log in window, enter your username and password.

When logging in for the first time to an unconfigured system, use **admin** as the username and **password** as the password.

Step 4 Click **Log In**.

The **Change Password** dialog box only appears the first time you log into CIMC.

- Step 5** Change the password as appropriate and save.
The CIMC home page is displayed.
-

Activating a Virtual Device

You will have to launch the KVM Console to activate virtual devices.

Before you begin

Ensure that you have the Java 1.6.0_14 or a higher version installed on your local system.

- Step 1** Download the Cisco Enterprise NFVIS image from a prescribed location to your local system.
- Step 2** From CIMC, select the **Server** tab, and click **Launch KVM Console**.
- Note** A JNLP file will be downloaded to your system. You must open the file immediately after it is downloaded to avoid the session timeout.
- Step 3** Open the renamed *.jnlp* file. When it prompts you to download Cisco Virtual KVM Console, click **Yes**. Ignore all security warnings and continue with the launch.
The KVM Console is displayed.
- Step 4** From the **Virtual Media** menu on the KVM Console, select **Activate Virtual Devices**.
If prompted with an unencrypted virtual media session message, select **Accept this session**, and click **Apply**. The virtual devices are activated now.
-

Mapping the Cisco Enterprise NFVIS Image

- Step 1** From the **Virtual Media** menu on the KVM Console, select **Map CD/DVD...**
- Step 2** Browse for the installation file (ISO) on your local system, and select it .
- Step 3** Click **Map Device**.
The ISO image file is now mapped to the CD/DVD.
-

Installing Cisco Enterprise NFVIS on Cisco UCSE-Series Servers

Before you begin

- Configure the UCS E interface on the Cisco ISR router.
- Configure the Gigabit Ethernet interface on the Cisco ISR router.

- Ensure that you have the IP address configured for CIMC access as well as a login account with administrative privileges.
- Ensure that the Cisco UCS E server has one of the following supported firmware versions or above:
 - BIOS UCSED.2.5.0.3 or later for UCS-E160D-M2/K9 and UCS-E180D-M2/K9
 - BIOS UCSES.1.5.0.5 or later for UCS-E140S-M2/K9

For more details on how to perform the basic configuration on the Cisco ISR routers, see the following guides:

- [Sample Configuration on the Cisco ISR Router to Bring Up a Cisco UCS E Server, on page 10](#)
- [Getting Started Guide for Cisco UCS E-Series Servers, Release 1.0\(2\) Installed in the Cisco ISR 4451-X](#)

For details on how to configure an IP address for CIMC, see the [Getting Started Guide for Cisco UCS E-Series Servers, Release 1.0](#) on cisco.com.

-
- Step 1** Log into CIMC.
For details, see [Logging Into the CIMC GUI , on page 7](#)
- Step 2** From the **Server** tab, click **Launch KVM Console**.
The KVM Console opens in a separate window.
- Step 3** From the KVM console, click the **Virtual Media** tab.
- Step 4** In the **Virtual Media** tab, map the virtual media using either of the following methods:
- a) Select the **Mapped** check box for the CD/DVD drive containing the operating system.
 - b) Click **Add Image**, browse, and select the Cisco Enterprise NFVIS ISO image, click **Open** to mount the image, and then select the **Mapped** check box for the mounted image.
- You must keep the **Virtual Media** tab open during the installation process. Closing the tab unmaps all virtual media.
- Step 5** From the **Server** tab, select **BIOS**.
- Step 6** From the **BIOS Actions** area, select **Configure Boot Order**.
The **Configure Boot Order** dialog box appears.
- Step 7** From the **Device Types** area, select **CD/DVD Linux Virtual CD/DVD**, and then click **Add**.
- Step 8** Select **HDD PCI RAID Adapter**, and then click **Add**.
- Step 9** Set the boot order sequence using the **Up** and **Down** options. The **CD/DVD Linux Virtual CD/DVD** boot order option must be the first choice.
- Step 10** Click **Apply** to complete the boot order setup.
- Step 11** Reboot the server by selecting the **Power Off Server** option from the **Server Summary** page in CIMC.
- Step 12** After the server is down, select the **Power On Server** option in CIMC.

When the server reboots, the KVM console will automatically install Cisco Enterprise NFVIS from the virtual CD/DVD drive. The entire installation might take 30 minutes to one hour to complete.
- Step 13** After the installation is complete, the system is automatically rebooted from the hard drive. Log into the system when the command prompt changes from "localhost" to "nfvis" after the reboot.
Wait for some time for the system to automatically change the command prompt. If it does not change automatically, press **Enter** to manually change the command prompt from "localhost" to "nfvis". Use **admin** as the login name and **Admin123#** as the default password.

Note The system prompts you to change the default password at the first login attempt. You must set a strong password as per the on-screen instructions to proceed with the application. You cannot run API commands or proceed with any tasks unless you change the default password at the first login. API will return 401 unauthorized error if the default password is not reset.

Step 14 You can verify the installation using the System API or by viewing the system information from the Cisco Enterprise NFV portal.

What to do next

You can verify the default configuration, and set up initial IP configuration to launch the Cisco Enterprise NFV portal. For details, see [Setting Up System Configuration](#).

Sample Configuration on the Cisco ISR Router to Bring Up a Cisco UCS E Server

The following sample configuration shows the basic configuration performed on the Cisco ISR 4451 router with DHCP enabled.

```
Last configuration change at 02:36:37 UTC Thu Feb 18 2016
!
version 15.5
service timestamps debug datetime msec
service timestamps log datetime msec
no platform punt-keepalive disable-kernel-core
!
hostname NFVIS-ISR4451
!
boot-start-marker
boot system bootflash:isr4300-universalk9.03.16.01a.S.155-3.S1a-ext.SPA.bin
boot-end-marker
!
!
vrf definition Mgmt-intf
!
address-family ipv4
exit-address-family
!
address-family ipv6
exit-address-family
!
!
no aaa new-model
!
!
!
ip domain name cisco.com
!
!
!
subscriber templating
!
multilink bundle-name authenticated
!
!
!
```

```
license udi pid ISR4331/K9 sn FDO192207MN
!
!
ucse subslot 1/0
imc access-port shared-lom console
imc ip address 172.19.183.172 255.255.255.0 default-gateway 172.19.183.1
!
spanning-tree extend system-id
!
!
redundancy
 mode none
!
!
!
vlan internal allocation policy ascending
!
!
!
interface GigabitEthernet0/0/0
 ip address 172.19.183.171 255.255.255.0
 media-type rj45
 negotiation auto
!
interface GigabitEthernet0/0/1
 no ip address
 shutdown
 negotiation auto
!
interface GigabitEthernet0/0/2
 no ip address
 shutdown
 negotiation auto
!
interface ucse1/0/0
ip unnumbered GigabitEthernet0/0/0
negotiation auto
switchport mode trunk
no mop enabled
no mop sysid
!
interface ucse1/0/1
 no ip address
 no negotiation auto
 switchport mode trunk
 no mop enabled
 no mop sysid
!
interface GigabitEthernet0
 vrf forwarding Mgmt-intf
 no ip address
 shutdown
 negotiation auto
!
interface Vlan1
 no ip address
 shutdown
!
ip default-gateway 172.19.183.1
ip forward-protocol nd
no ip http server
no ip http secure-server
ip tftp source-interface GigabitEthernet0
ip route 0.0.0.0 0.0.0.0 172.19.183.1
```

```

ip route 172.19.183.172 255.255.255.255 ucse1/0/0
ip ssh version 2
!
!
!

control-plane
!
!
line con 0
  stopbits 1
line aux 0
  stopbits 1
line vty 0 4
  password lab
  login local
  transport input all
  transport output all
!
!
end

```

Installing Cisco Enterprise NFVIS on a Cisco ENCS 5100 and 5400



Note Software or hardware RAID controller setup is not supported with Cisco ENCS in Cisco Enterprise NFVIS Release 3.5.1.

Before you begin

- Make sure that you have configured the IP address to access CIMC.
- If not installed, install Adobe Flash Player 10 or later on your local machine.

For details on how to configure an IP address for CIMC, see the [Set up CIMC for UCS C-Series Server](#) and [Getting Started Guide for Cisco UCS E-Series Servers and the Cisco UCS E-Series Network Compute Engine](#) on cisco.com.

-
- Step 1** In your web browser, enter the IP address that you configured to access CIMC during initial setup.
- Step 2** If a security dialog box displays, do the following:
- Optional:** Select the check box to accept all content from Cisco.
 - Click **Yes** to accept the certificate and continue.
- Step 3** In the **Log in** window, enter your username and password.
- When logging in for the first time to an unconfigured system, use **admin** as the username and **password** as the password.
- Step 4** Click **Log In**.
- The **Change Password** dialog box only appears the first time you log into CIMC.

- Step 5** Change the password as appropriate and save.
The CIMC home page is displayed.
- Step 6** From the CIMC **Server** tab, select **Summary**, and click **Launch KVM Console**.
The KVM Console opens in a separate window.
- Step 7** From the **Virtual Media** menu on the KVM Console, select **Activate Virtual Devices** .
If prompted with an unencrypted virtual media session message, select **Accept this session**, and click **Apply**. The virtual devices are activated now.
- Step 8** From the **Virtual Media** menu on the KVM Console, select **Map CD/DVD**.
- Step 9** Browse for the installation file (ISO) on your local system, and select it.
- Step 10** Click **Map Device**.
The ISO image file is now mapped to the CD/DVD.
- Step 11** From the CIMC **Server** tab, select **BIOS**.
- Step 12** From the **BIOS Actions** area, select **Configure Boot Order**.
The **Configure Boot Order** dialog box appears.
- Step 13** From the **Device Types** area, select **CD/DVD Linux Virtual CD/DVD**, and then click **Add**.
- Step 14** Select **HDD**, and then click **Add**.
- Step 15** Set the boot order sequence using the **Up** and **Down** options. The **CD/DVD Linux Virtual CD/DVD** boot order option must be the first choice.
- Step 16** Click **Apply** to complete the boot order setup.
- Step 17** Reboot the server by selecting the **Power Off Server** option from the **Server Summary** page in CIMC.
- Step 18** After the server is down, select the **Power On Server** option in CIMC.
When the server reboots, the KVM console will automatically install Cisco Enterprise NFVIS from the virtual CD/DVD drive. The entire installation might take 30 minutes to one hour to complete.
- Step 19** After the installation is complete, the system is automatically rebooted from the hard drive. Log into the system when the command prompt changes from "localhost" to "nfvis" after the reboot.
Wait for some time for the system to automatically change the command prompt. If it does not change automatically, press **Enter** to manually change the command prompt from "localhost" to "nfvis". Use **admin** as the login name and **Admin123#** as the default password.
- Note** The system prompts you to change the default password at the first login. You must set a strong password as per the on-screen instructions to proceed with the application. You cannot run API commands or proceed with any tasks unless you change the default password at the first login. API will return 401 unauthorized error if the default password is not reset.
- Step 20** You can verify the installation using the System API or by viewing the system information from the Cisco Enterprise NFVIS portal.
-

Installing Cisco Enterprise NFVIS on a Cisco ENCS 5104

- Step 1** Create bootable usb with NFVIS image.

In this example, we used Rufus utility in Windows environment. Rufus utility can be downloaded <https://rufus.akeo.io/>. For this example, following parameters were used to burn bootable NFVIS USB device:

- Device: USB stick
- Partition scheme: MBR
- Filesystem: FAT32
- Cluster size: use default
- Volume label: use default
- Quick format: checked
- Create bootable: select "ISO Image" and click next icon then choose NFVIS image.
- Create extended label: checked

Press **Start** and wait for completion.

Eject USB thumb drive

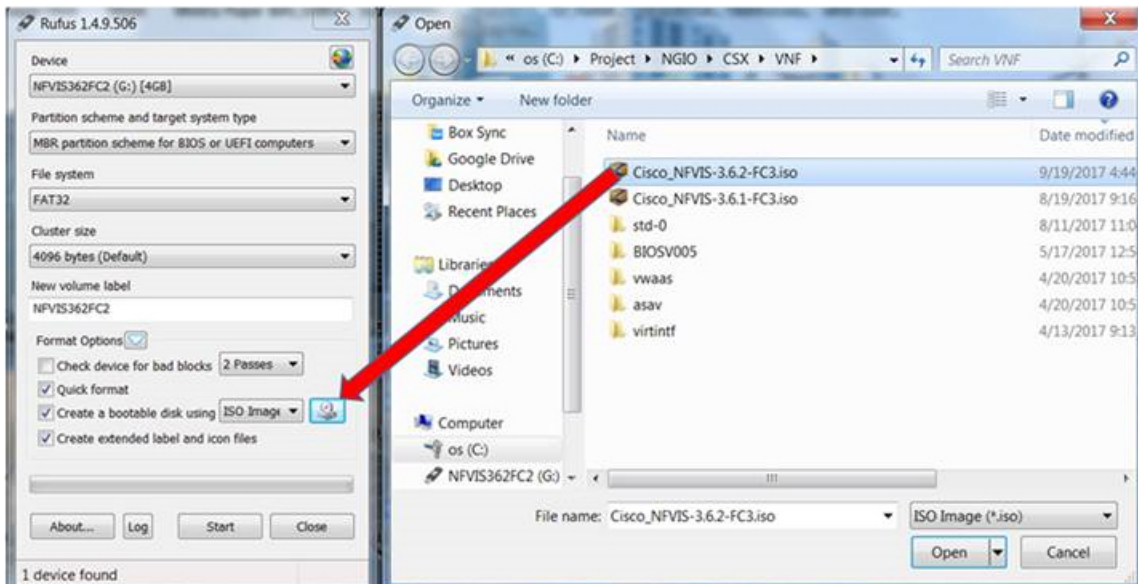

366854

Step 2 Insert USB device in one of USB slot in ENCS5104.

Step 3 Power on system.

Step 4 During system boot up, press F6 key.

Press or <F2> to enter setup, <F6> Boot Menu, <F12> Network Boot in 5 seconds or press any key to continue.

Step 5 Once you press F6, you will see the following screenshot to select which device you want to boot from. Select your USB device.

In the following screenshot example, there is STEC USB being used. That display will vary depending on your usb device vendor. Use the arrow key to select that device.

```

-----
                Select Boot Device or BIOS Setup
-----
P0: Micron_1100_MTFDDAV256TBN
CISCO eMMC HS-SD/MMC
IBA GE Slot 0100 v1578
IBA GE Slot 0300 v1578
IBA GE Slot 0301 v1578
IBA GE Slot 0302 v1578
IBA GE Slot 0303 v1578
UEFI: CISCO eMMC HS-SD/MMC, Partition 1
UEFI: CISCO eMMC HS-SD/MMC, Partition 2
UEFI: Built-in EFI Shell
STEC STEC USB 2.0 3120 ←
UEFI: STEC STEC USB 2.0 3120, Partition 1
Enter BIOS Setup
-----

^ and v to move selection
ENTER to select boot device

```

366780

- Step 6** Wait until installation is completed. System will be rebooted once installation is done.
- Step 7** Log into the system with username **admin** and **Admin123#** as a default password
- Step 8** You will be prompted and asked to change password at the first login. You must set a strong password per the on-screen instruction to proceed.
- Step 9** You can verify the installation status using the System API or command line interface per the NFVIS user guide.

What to do next

You can verify the default configuration, and set up initial IP configuration to launch the Cisco Enterprise NFV portal. For details, see [Setting Up System Configuration](#).



CHAPTER 3

Setting Up System Configuration

- [Default System Configuration on the Cisco ENCS, on page 17](#)
- [Default System Configuration on the Cisco UCS C220 M4 Server and Cisco CSP 2100, on page 19](#)
- [Default System Configuration on the Cisco UCS E-Series Servers , on page 20](#)
- [Setting Up Initial Configuration, on page 20](#)
- [User Roles and Authentication, on page 28](#)
- [Configuring the IP Receive ACL, on page 32](#)
- [Configuring Your Banner and Message of the Day, on page 33](#)
- [Setting the System Time Manually or With NTP, on page 34](#)
- [Enabling or Disabling the Portal Access, on page 35](#)
- [Configuring System Logs, on page 36](#)
- [Network File System Support, on page 37](#)
- [Secure Boot of host, on page 38](#)
- [CIMC Control, on page 39](#)
- [DPDK Support on NFVIS, on page 40](#)
- [Import and Export NFVIS VM, on page 44](#)
- [Backup and Restore NFVIS and VM Configurations, on page 45](#)
- [Dynamic SR-IOV, on page 47](#)

Default System Configuration on the Cisco ENCS

The diagram below illustrates the default network configuration of Cisco Enterprise NFVIS with the Cisco ENCS.

Figure 1: Default Network Configuration of Cisco Enterprise NFVIS with the Cisco ENCS 5400

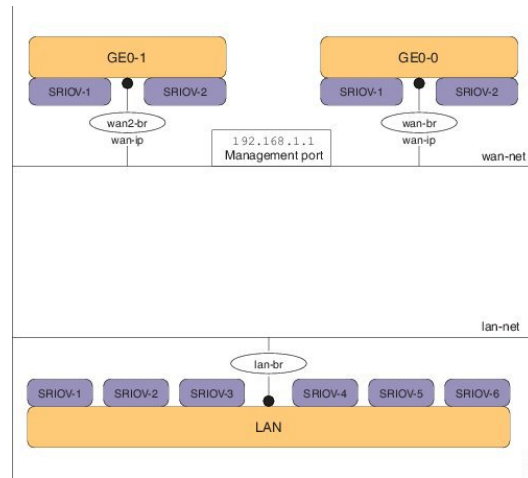
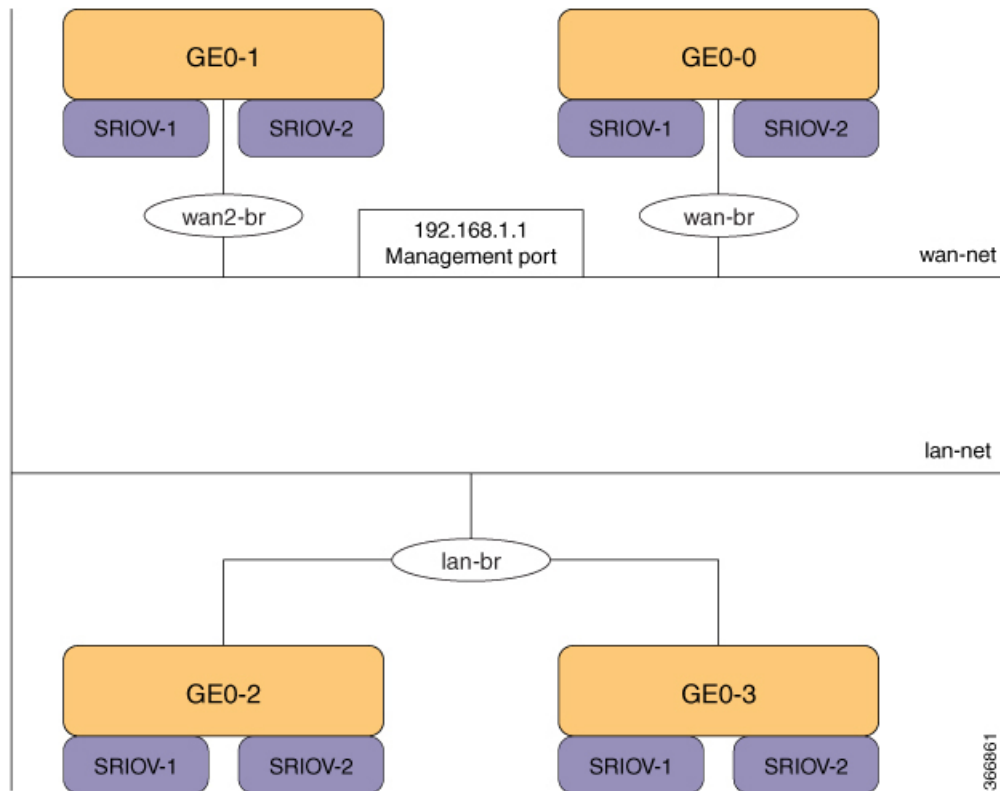

Figure 2: Default Network Configuration of Cisco Enterprise NFVIS with the Cisco ENCS 5100



- LAN ports—Eight physical Gigabit Ethernet ports for inbound and outbound traffic.
- WAN port—You can use one of the dual media Ethernet ports (wan-br and wan2-br) for DHCP connection.
- Bridges—They form a Layer 2 domain between virtual network interface controllers (vNICs) of VMs. A vNIC is used by a virtual machine to provide virtual network interfaces by defining a range of MAC addresses. The default management IP address (192.168.1.1) for the NFVIS host is configured on the management port. Multiple VMs can use the same LAN port for local connectivity.

- Network—It is a segment Layer 2 bridge domain where only the specific VLAN traffic is allowed.
- Reserved VLANs in the LAN network on the ENCS 5400 platform—The VLAN range 2350-2449 is reserved for internal use and should not be used on the external switch ports and for virtual machines in the LAN ports". Note that this limitation doesn't apply to the WAN ports.
- Internal 192.168.10.0/24 and 192.168.50.0/24 networks—The IP subnet 192.168.10.0/24 and 192.168.50.0/24 are used for the ENCS-5400 internal networks. A user should not use this IP subnet on the NFVIS management network. In the future NFVIS releases, this internal subnet will be isolated so that users can use this for NFVIS management.



Note The following networks and bridges are automatically configured. You can configure more as required.

- A LAN network (lan-net) and a LAN bridge (lan-br)
- A WAN network (wan-net) and a WAN bridge (wan-br)

wan2-net and wan2-br are the default configurations for ENCS 5400 and ENCS 5100.

The default networks and bridges cannot be deleted.

Default System Configuration on the Cisco UCS C220 M4 Server and Cisco CSP 2100

Configuring the networks in Cisco Enterprise NFVIS allows inbound and outbound traffic and VMs to be service chained. The following diagram illustrates the default network configuration:

Figure 3: Default Network Configuration with Cisco UCS C220 M4 and Cisco CSP 2100

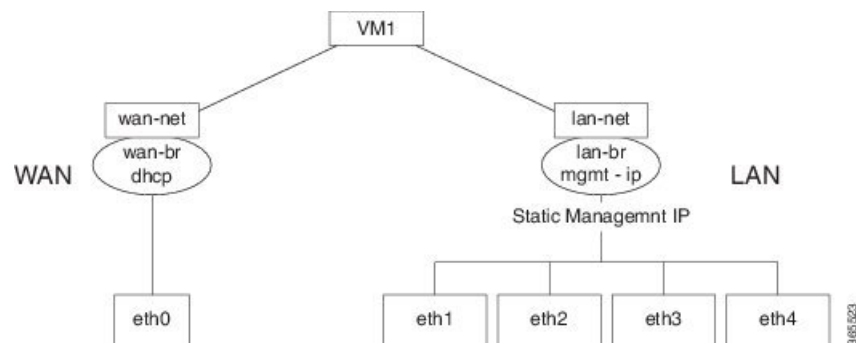

The following networks and bridges are created by default, and cannot be deleted. You can configure more as required.

- A LAN network (lan-net) and a LAN bridge (lan-br)—The default static management IP address (192.168.1.1) for the NFVIS host is configured on the LAN bridge. All other ports for inbound and outbound traffic are associated with the LAN bridge. Any LAN port can be used to access the default static IP address. By default, the hostname is set to "nfvis".

- A WAN network (wan-net) and a WAN bridge (wan-br)—This is created with the "eth0" port, and is configured to enable the DHCP connection.

By default, the first port on the device is associated with the WAN bridge. All the other ports on the device are associated with the LAN bridge.

For more details about the initial setup, see the Installing the Server chapter in the *Cisco UCS C220 M4 Server Installation and Service Guide* or *Cisco Cloud Services Platform 2100 Hardware Installation Guide*.

Default System Configuration on the Cisco UCS E-Series Servers

Figure 4: Default Network Configuration with a Cisco UCS E-Series Server

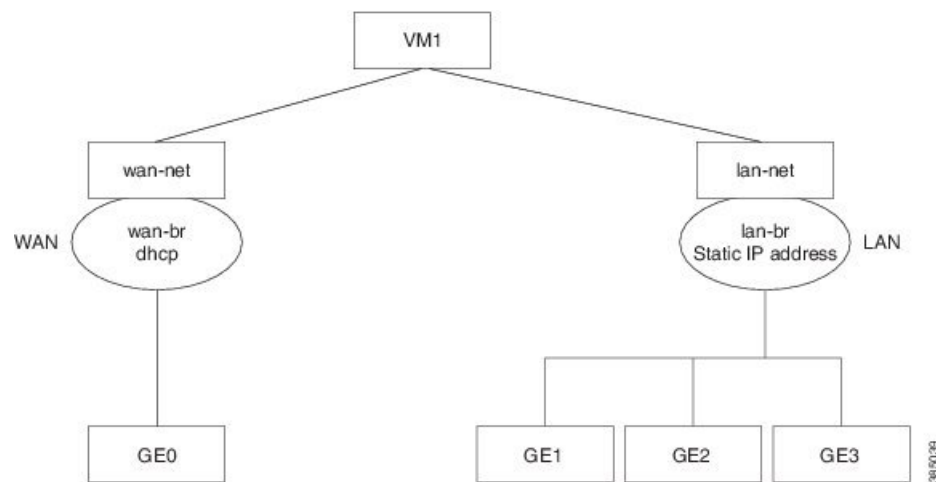

The following networks and bridges are created by default, and cannot be deleted. You can configure more as required.

- A LAN network (lan-net) and a LAN bridge (lan-br)—The default static management IP address (192.168.1.1) for the NFVIS host is configured on the LAN bridge. All other ports for inbound and outbound traffic are associated with the LAN bridge. By default, the hostname is set to "nfvis".
- A WAN network (wan-net) and a WAN bridge (wan-br)— The physical WAN ports are on the Cisco ISR module. They are not externally available on the Cisco UCS E server. The WAN traffic comes from the ISR WAN ports, and goes through the backplane to the Cisco UCS-E server. The backplane has one internal WAN interface (GE0) to establish connection with the Cisco UCS-E server. By default, the "GE0" interface is enabled for the DHCP connection.

For more details on the initial setup, see the [Getting Started Guide for Cisco UCS E-Series Servers](#) and the [Cisco UCS E-Series Network Compute Engine](#).

Setting Up Initial Configuration

For initial login, use **admin** as the default user name, and **Admin123#** as the default password. Immediately after the initial login, the system prompts you to change the default password. You must set a strong password as per the on-screen instructions to proceed with the application. All other operations are blocked until default password is changed. API will return 401 unauthorized error if the default password is not reset.

If wan-br and wan2-br has not obtained IP addresses through DHCP, the zero touch deployment is terminated. To manually apply the IP configurations answer 'y' and the system proceeds with dhclient on wan-br until the configurations are changed. For dhclient to continue to request IP address for PnP flow on both WAN interfaces answer 'n'.

You must follow the rules to create a strong password:

- Must contain at least one upper case and one lower case letter.
- Must contain at least one number and one special character (# _ - * ?).
- Must contain seven characters or greater. Length should be between 7 and 128 characters.

You can change the default password in three ways:

- Using the Cisco Enterprise NFVIS portal.
- Using the CLI—When you first log into Cisco Enterprise NFVIS through SSH, the system will prompt you to change the password.
- Using PnP (for details, see the [Cisco Network Plug-n-Play Support](#) , on page 49).
- Using console - After the initial login using the default password, you are prompted to change the default password.

```
NFVIS Version: 3.10.0-9
```

```
Copyright (c) 2015-2018 by Cisco Systems, Inc.  
Cisco, Cisco Systems, and Cisco Systems logo are registered trademarks of Cisco  
Systems, Inc. and/or its affiliates in the U.S. and certain other countries.
```

```
The copyrights to certain works contained in this software are owned by other  
third parties and used and distributed under third party license agreements.  
Certain components of this software are licensed under the GNU GPL 2.0, GPL 3.0,  
LGPL 2.1, LGPL 3.0 and AGPL 3.0.
```

```
nfvis login: console (automatic login)
```

```
login:  
login:  
login:  
login:  
login: admin
```

```
Cisco Network Function Virtualization Infrastructure Software (NFVIS)
```

```
NFVIS Version: 3.10.0-9
```

```
Copyright (c) 2015-2018 by Cisco Systems, Inc.  
Cisco, Cisco Systems, and Cisco Systems logo are registered trademarks of Cisco  
Systems, Inc. and/or its affiliates in the U.S. and certain other countries.
```

```
The copyrights to certain works contained in this software are owned by other  
third parties and used and distributed under third party license agreements.  
Certain components of this software are licensed under the GNU GPL 2.0, GPL 3.0,  
LGPL 2.1, LGPL 3.0 and AGPL 3.0.
```

```
admin@localhost's password:
```

```
admin connected from ::1 using ssh on nfvis  
nfvis# show version
```



Note To commit the target configuration to the active (running) configuration, use the **commit** command in any configuration mode in Cisco Enterprise NFVIS Release 3.5.1 and later. Changes made during a configuration session are inactive until the **commit** command is entered. By default, the commit operation is pseudo-atomic, meaning that all changes must succeed for the entire commit operation to succeed.

Connecting to the System

Using IPv4

The three interfaces that connect the user to the system are the WAN and WAN2 interfaces and the management interface. By default, the WAN interface has the DHCP configuration and the management interface is configured with the static IP address 192.168.1.1. If the system has a DHCP server connected to the WAN interface, the WAN interface will receive the IP address from this server. You can use this IP address to connect to the system.

You can connect to the server locally (with an Ethernet cable) using the static management IP address; to connect to the box remotely using a static IP address, the default gateway needs to be configured.

You can connect to the system in the following three ways:

- Using the local portal—After the initial login, you are prompted to change the default password.
- Using the KVM console—After the initial login using the default password, you are prompted to change the default password.
- Using PnP—After the initial provisioning through PnP, the configuration file pushed by the PNP server must include the new password for the default user (admin).

Using IPv6

IPv6 can be configured in static, DHCP stateful and Stateless Autoconfiguration (SLAAC) mode. By default, DHCP IPv6 stateful is configured on the WAN interface. If DHCP stateful is not enabled on the network, the router advertisement (RA) flag decides which state the network stays in. If the RA shows Managed (M) flag, then the network stays in DHCP mode, even if there is no DHCP server in the network. If the RA shows Other (O) flag, then the network switches from DHCP server to SLAAC mode.

SLAAC provides ipv6 address and default gateway. Stateless dhcp is enabled in the SLAAC mode. If the server has dns and domain configured, then SLAAC also provides those values via stateless dhcp.

Performing Static Configuration without DHCP



Note Starting from NFVIS 3.10.1 release, for ENCS 5400 and ENCS 5100, wan2-br obtains an IP address from DHCP. To configure default gateway, first use **no bridges bridge wan2-br dhcp** command.

If you want to disable DHCP and use static configuration, initial configuration is done by setting the WAN IP address and/or management IP address, and the default gateway. You can also configure a static IP on a created bridge.

To perform initial configuration on the system without using DHCP:

```
configure terminal
```



```

system settings mgmt ip address 192.168.1.2 255.255.255.0
bridges bridge wan-br ip address 209.165.201.22 255.255.255.0
system settings default-gw 209.165.201.1
commit

```



Note When an interface is configured with a static IP address, DHCP is automatically disabled on that interface.

Now you can either use the management IP or WAN IP to access the portal.

To configure static IPv6 on the WAN interface:

```

configure terminal
system settings mgmt ipv6 address 2001:DB8:1:1::72/64
bridges bridge wan-br ipv6 address 2001:DB8:1:1::75/64
system settings default-gw-ipv6 2001:DB8:1:1::76
commit

```



Note When an interface is configured with a static IPv6 address, DHCP IPv6 is automatically disabled on that interface. There are three options for IPv6 - static, DHCP and SLAAC, out of which only one can be enabled at a time.

Configuring DHCP on the WAN or Management Interface



Note Starting from NFVIS 3.10.1, you can configure DHCP on any bridge. You can only have one DHCP bridge or management interface active at a time, and cannot have DHCP and default gateway configured at the same time.

You can configure DHCP either on the WAN interface or the management interface; you cannot configure DHCP on both the interfaces simultaneously.

To configure DHCP on any one of the interfaces (WAN or management), delete the default gateway.

To configure DHCP on the management interface:

```

configure terminal
no system settings default-gw
system settings mgmt dhcp
commit
exit
hostaction mgmt-dhcp-renew

```

To configure DHCP IPv6 on the management interface:

```

configure terminal
no system settings default-gw-ipv6
system settings mgmt dhcp-ipv6
commit
exit
hostaction mgmt-dhcp-renew

```

To configure DHCP on the WAN interface:

```
configure terminal
no system settings default-gw
system settings wan dhcp
commit
exit
hostaction wan-dhcp-renew
```



Note Starting from NFVIS 3.10.1, you can configure DHCP IPv6 on any bridge. You can only have one DHCP IPv6 bridge or management interface active at a time, and cannot have DHCP IPv6 and default gateway IPv6 or SLAAC IPv6 configured at the same time.

To configure DHCP IPv6 on the WAN interface:

```
configure terminal
no system settings default-gw-ipv6
system settings wan dhcp-ipv6
commit
exit
hostaction wan-dhcp-renew
```

Configuring SLAAC on the WAN or Management Interface



Note Starting from NFVIS 3.10.1, you can configure SLAAC IPv6 on any bridge. You can only have one SLAAC IPv6 bridge or management interface active at a time, and cannot have SLAAC IPv6 and default gateway IPv6 or DHCP IPv6 configured at the same time.

To configure SLAAC IPv6 on the WAN interface:

```
configure terminal
system settings wan slaac-ipv6
commit
```

To configure SLAAC IPv6 on the management interface:

```
configure terminal
system settings mgmt slaac-ipv6
commit
```

Verifying Initial Configuration

The **show system settings-native** command is used to verify initial configuration. Use **show bridge-settings** and **show bridge-settings *bridge_name*** commands to verify the configuration for any bridge on the system.

Extract from the output of the **show system settings-native** command when both WAN and management interfaces have a static configuration:

```
system settings-native mgmt ip-info interface lan-br
system settings-native mgmt ip-info ipv4_address 192.168.1.2
system settings-native mgmt ip-info netmask 255.255.255.0
```

```

!
!
!
system settings-native mgmt dhcp disabled
system settings-native wan ip-info interface wan-br
system settings-native wan ip-info ipv4_address 209.165.201.22
system settings-native wan ip-info netmask 255.255.255.0
!
!
!
system settings-native wan dhcp disabled
!
!
system settings-native gateway ipv4_address 209.165.201.1
system settings-native gateway interface wan-br

```

Extract from the output of the **show system settings-native** command when the management interface has a DHCP configuration and the WAN interface has a static configuration:

```

system settings-native mgmt ip-info interface MGMT
system settings-native mgmt ip-info ipv4_address 192.168.1.2
system settings-native mgmt ip-info netmask 255.255.255.0
!
!
!
system settings-native mgmt dhcp enabled
system settings-native wan ip-info interface wan-br
system settings-native wan ip-info ipv4_address 209.165.201.22
system settings-native wan ip-info netmask 255.255.255.0
!
!
!
system settings-native wan dhcp disabled

```

Extract from the output of the **show system settings-native** command when the WAN interface has a DHCP configuration and the management interface has a static configuration:

```

system settings-native mgmt ip-info interface lan-br
system settings-native mgmt ip-info ipv4_address 209.165.201.2
system settings-native mgmt ip-info netmask 255.255.255.0
!
!
!
system settings-native mgmt dhcp disabled
system settings-native wan ip-info interface wan-br
system settings-native wan ip-info ipv4_address 209.165.201.22
system settings-native wan ip-info netmask 255.255.255.0
!
!
!
system settings-native wan dhcp enabled

```

Related APIs and Commands

APIs	Commands
<ul style="list-style-type: none"> • /api/operational/system/settings-native • /api/config/system/settings • /api/operational/bridge-settings • /api/config/bridges/bridge/ 	<ul style="list-style-type: none"> • system settings hostname • system settings default-gw • system settings mgmt ip address • system settings mgmt dhcp • system settings wan ip address • system settings wan dhcp • hostaction wan-dhcp-renew • hostaction mgmt-dhcp-renew • bridges bridge wan-br ip address • bridges bridge wan-br dhcp • bridges bridge wan2-br ip address • bridges bridge wan2-br dhcp • bridges bridge user-br ip address • bridges bridge user-br dhcp • hostaction bridge-dhcp-renew bridge wan-br • hostaction bridge-dhcp-renew bridge wan2-br • hostaction bridge-dhcp-renew bridge user-br

Configuring VLAN for NFVIS Management Traffic

A VLAN is a method of creating independent logical networks within a physical network. VLAN tagging is the practice of inserting a VLAN ID into a packet header in order to identify which VLAN the packet belongs to.

You can configure a VLAN tag on the WAN bridge (wan-br) interface to isolate Cisco Enterprise NFVIS management traffic from VM traffic. You can also configure VLAN on any bridge on the system (wan2-br for ENCS5400 or ENCS 5100, and user-br for all systems)

By default, Wan bridge and LAN bridge are in trunk mode and allows all VLANs. When you configure native VLAN, you must also configure all the allowed VLANs at the same time. The native VLAN becomes the only allowed VLAN if you do not configure all the VLANs. If you want a network that allows only one VLAN, then create another network on top of wan-net and lan-net and make it access network.



Note You cannot have the same VLAN configured for the NFVIS management and VM traffic.

For more details on the VLAN configuration, see the Understanding and Configuring VLANs module in the [Catalyst 4500 Series Switch Cisco IOS Software Configuration Guide](#).

To configure a VLAN:

```
configure terminal
bridges bridge wan-br vlan 120
commit
```

Verifying VLAN Configuration

Run the **show bridge-settings wan-br vlan** command to verify the VLAN configuration as shown below:

```
nfvis# show bridge-settings wan-br vlan
bridges bridge wan-br vlan 120
```

VLAN APIs and Commands

VLAN APIs	VLAN Commands
<ul style="list-style-type: none"> • /api/config/bridges/bridge/wan-br/vlan • /api/config/bridges/bridge/wan2-br/vlan • /api/config/bridges/bridge/user-br/vlan • /api/operational/bridge-settings/bridge/wan-br/vlan • /api/operational/bridge-settings/bridge/wan2-br/vlan • /api/operational/bridge-settings/bridge/user-br/vlan 	<ul style="list-style-type: none"> • bridges bridge wan2-br vlan • bridges bridge user-br vlan • show bridge-settings wan-br vlan • show bridge-settings wan2-br vlan • show bridge-settings user-br vlan • show bridge-settings vlan

Configuring System Routes

In addition to the default routes in the system, you can configure additional system routes. This configuration is specifically useful when certain destinations are not reachable through the default routes.

While you can create a route just by providing the destination and prefix length, a valid route requires that you specify either a device or a gateway or both.

To configure additional system routes:

```
configure terminal
system routes route 209.165.201.1 dev lan-br
commit
```

Verifying the System Routes Configuration

To verify the system routes configuration, use the **show system routes** command as shown below:

```

nfvis# show system routes
DESTINATION PREFIXLEN STATUS
-----
209.165.201.1 12 -
209.165.201.2 12 -
209.165.201.3 24 -

```

System Routes APIs and Commands

System Routes APIs	System Routes Commands
<ul style="list-style-type: none"> • /api/config/system/routes • /api/config/system/routes/route/<host destination,netmask> 	<ul style="list-style-type: none"> • system routes route • show system routes

User Roles and Authentication

Role based access enables the administrator to manage different levels of access to the system's compute, storage, database, and application services. It uses the access control concepts such as users, groups, and rules, which you can apply to individual API calls. You can also keep a log of all user activities.

Table 1: Supported User Roles and Privileges

User Role	Privilege
Administrators	Owens everything, can perform all tasks including changing of user roles, but cannot delete basic infrastructure. Admin's role cannot be changed; it is always "administrators".
Operators	Start and stop a VM, and view all information
Auditors	Read-only permission

Rules for User Passwords

The user passwords must meet the following requirements:

- Must have at least seven characters length or the minimum required length configured by the admin user.
- Must not have more than 128 characters.
- Must contain a digit.
- Must contain one of the following special characters: hash (#), underscore (_), hyphen (-), asterisk (*), and question mark (?).
- Must contain an uppercase character and a lowercase character.
- Must not be same as last five passwords.

Creating Users and Assigning Roles

The administrator can create users and define user roles as required. You can assign a user to a particular user group. For example, the user "test1" can be added to the user group "administrators".



Note All user groups are created by the system. You cannot create or modify a user group.

To create a user:

```
configure terminal
rbac authentication users create-user name test1 password Test1_pass role administrators
commit
```

To delete a user:

```
configure terminal
rbac authentication users delete-user name test1
commit
```



Note To change the password, use the **rbac authentication users user change-password** command in global configuration mode. To change the user role, use the **rbac authentication users user change-role** command in global configuration mode.

User Management APIs and Commands

User Management APIs	User Management Commands
<ul style="list-style-type: none"> • /api/operations/rbac/authentication/users/user/<user-name>/change-password • /api/operations/rbac/authentication/users/user/oper/change-role • /api/config/rbac/authentication/users/user?deep 	<ul style="list-style-type: none"> • rbac authentication users • rbac authentication users user change-password • rbac authentication users user change-role

Configuring Minimum Length for Passwords

The admin user can configure the minimum length required for passwords of all users. The minimum length must be between 7 to 128 characters. By default, the minimum length required for passwords is set to 7 characters.

```
configure terminal
rbac authentication min-pwd-length 10
commit
```

Minimum Password Length APIs and Commands

APIs	Commands
/api/config/rbac/authentication/	rbac authentication min-pwd-length

Configuring Password Lifetime

The admin user can configure minimum and maximum lifetime values for passwords of all users and enforce a rule to check these values. The default minimum lifetime value is set to 1 day and the default maximum lifetime value is set to 60 days.

When a minimum lifetime value is configured, the user cannot change the password until the specified number of days have passed. Similarly, when a maximum lifetime value is configured, a user must change the password before the specified number of days pass. If a user does not change the password and the specified number of days have passed, a notification is sent to the user.



Note The minimum and maximum lifetime values and the rule to check for these values are not applied to the admin user.

```
configure terminal
rbac authentication password-lifetime enforce true min-days 2 max-days 30
commit
```

Password Lifetime APIs and Commands

APIs	Commands
/api/config/rbac/authentication/password-lifetime/	rbac authentication password-lifetime

Deactivating Inactive User Accounts

The admin user can configure the number of days after which an unused user account is marked as inactive and enforce a rule to check the configured inactivity period. When marked as inactive, the user cannot login to the system. To allow the user to login to the system, the admin user can activate the user account by using the **rbac authentication users user *username* activate** command.



Note The inactivity period and the rule to check the inactivity period are not applied to the admin user.

```
configure terminal
rbac authentication account-inactivity enforce true inactivity-days 2
commit
```

Deactivate Inactive User Accounts APIs and Commands

APIs	Commands
/api/config/rbac/authentication/account-inactivity/	rbac authentication account-inactivity

Activating an Inactive User Account

The admin user can activate the account of an inactive user.

```
configure terminal
rbac authentication users user guest_user activate
commit
```

Activate Inactive User Account APIs and Commands

APIs	Commands
/api/operations/rbac/authentication/users/user/username/activate	rbac authentication users user activate

Certification

Generate Sign-Request

```
nfvis(config)# system certificate signing-request ?
```

Possible completions:

```
common-name          country-code
locality              organization
organization-unit-name state
```

The .csr file will be saved in /data/intdatastore/download/nfvis.csr

Use the scp command to download the file.

Install CA Sign Certificate

After CA sign in, the user needs to use the scp command to upload the file into nfvis.

```
nfvis(config)# system certificate install-cert path file:///<full path of the file>
```

The path needs to start with "file://"

Switch Certificate

```
nfvis(config)# system certificate use-cert cert-type ca-signed
```

nginx process restarts after the switch.

The users cannot access the log files. The log files are added to all the user actions and the user can download and view some of the logs from portal. A notification is generated when the log files reach 75% capacity.

Secure Copy Command

The secure copy (**scp**) command allows only the admin user to secure copy a file from the Cisco NFVIS to an external system or from an external system to Cisco NFVIS. The **scp** command is:

scp *source destination*



Note For detailed information about how to use the **scp** command to copy to or from supported locations, see the **scp** section in [Cisco Enterprise Network Function Virtualization Infrastructure Software Command Reference](#).

Examples

The following example copies the sample.txt file from intdatastore to an external system.

```
nfvis# scp intdatastore:sample.txt user@203.0.113.2:/Users/user/Desktop/sample.txt
```

The following example copies the test.txt file from an external system to intdatastore.

```
nfvis# scp user@203.0.113.2:/Users/user/Desktop/test.txt intdatastore:test_file.txt
```

The following example copies the test.txt file from an external system to USB.

```
nfvis# scp user@203.0.113.2:/user/Desktop/my_test.txt usb:usb1/test.txt
```

The following example copies the sample.txt file to an NFS location.

```
nfvis# scp user@203.0.113.2:/user/Desktop/sample.txt nfs:nfs_test/sample.txt
```

The following example copies the sample.txt file from an external system with IPv6 address.

```
nfvis# scp user@[2001:DB8:0:ABCD::1]:/user/Desktop/sample.txt intdatastore:sample.txt
```

The following example copies the nfvis_scp.log file to an external system.

```
nfvis# scp logs:nfvis_scp.log user@203.0.113.2:/Users/user/Desktop/copied_nfvis_scp.log
```

Configuring the IP Receive ACL

To filter out unwanted traffic, you can configure ip-receive-acl to block or allow certain traffic based on the IP address and service ports.

To configure the source network for Access Control List (ACL) access to the management interface:

```
configure terminal
system setting ip-receive-acl 198.0.2.0/24
commit
```

Verifying the Trusted IP Connection

Use the **show running-config system settings ip-receive-ac** command to display the configured source network for ACL access to the management interface

```

nfvis# show running-config system settings ip-receive-ac
system settings ip-receive-acl 198.51.100.11/24
service
[ ssh https scpd]
action accept
priority 100

```

Port 22222 and Management Interface ACL

Management interface ACL provides the Access Control List (ACL) to restrict the traffic through the management interface for setting up different ACL of subnet inside a big subnet. From 3.7.1 release, port 22222 is closed by default on an NFVIS system.

To open port 22222:

```

configure terminal
system settings ip-receive-acl 0.0.0.0/0 service scpd priority 2 action accept
commit

```



Note Priority can be set to any number, as long as there is no other ACL that drops packets from same IP with lower priority number.

Use **no system settings ip-receive-acl** to close port 22222. When an entry is deleted from **ip-receive-acl**, all configurations to that source are deleted since the source IP address is the key. To delete one service, configure other services again.



Note From 3.8.1 release, only an admin user can use the scp command on this port to upload or download only from restricted folders like /data/intdatastore/.

Use the **show running-config system settings ip-receive-acl** command to verify the interface configuration:

```

nfvis# show running-config system settings ip-receive-acl
system settings ip-receive-acl 10.156.0.0/16
service [ ssh https scpd ]
action accept
priority 100
!

```

Configuring Your Banner and Message of the Day

Cisco Enterprise NFVIS supports two types of banners: system-defined and user-defined banners. You cannot edit or delete the system-defined banner, which provides copyright information about the application. Banners are displayed on the login page of the portal.

You can post messages using the Message of the Day option. The message is displayed on the portal's home page when you log into the portal.

To configure your banner and message:

```
configure terminal
banner-motd banner "This is a banner" motd "This is the message of the day"
commit
```



Note Currently, you can create banners and messages in English only. You can view the system-defined banner using the **show banner-motd** command. This command does not display the user-defined banner or message.

Banner and Message APIs and Commands

Banner and Message APIs	Banner and Message Commands
<ul style="list-style-type: none"> • /api/config/banner-motd • /api/operational/banner-motd 	<ul style="list-style-type: none"> • banner-motd • show banner-motd

Setting the System Time Manually or With NTP

You can configure the Cisco Enterprise NFWIS system time manually or synchronise with an external time server using Network Time Protocol (NTP).

To set the system time manually:

```
configure terminal
system set-manual-time 2017-01-01T00:00:00
commit
```



Note NTP is automatically disabled when the time clock is set manually.

To set the system time using NTP IPv4:

```
configure terminal
system time ntp preferred_server 209.165.201.20 backup_server 1.ntp.esl.cisco.com
commit
```

To set the system time using NTP IPv6:

```
configure terminal
system time ntp-ipv6 2001:420:30d:201:ffff:ffff:fff4:35
commit
```

Verifying the System Time Configuration

To verify all system time configuration details, use the **show system time** command in privileged EXEC mode as shown below:

```
nfvis# show system time

system time current-time 2017-01-01T17:35:39+00:00
system time current-timezone "UTC (UTC, +0000)"

REMOTE          REFID  ST  T      WHEN      POLL      REACH      DELAY
  OFFSET          JITTER

-----

*calo-timeserver .GPS.  1      u      4  64      1      69.423
  2749736        0.000

* sys.peer and synced, o pps.peer, # selected, + candidate,
- outlier, . excess, x falseticker, space reject
```

If the NTP server is invalid, it will not be displayed in the table. Also, when an NTP server is queried, if a response is not received before the timeout, the NTP server will also not be displayed in the table.

System Time APIs and Commands

APIs	Commands
<ul style="list-style-type: none"> • /api/operations/system/set-manual-time • /api/config/system/time/ntp/preferred_server • /api/config/system/time/ntp/backup_server • /api/config/system/time/timezone • /api/operational/system/time?deep 	<ul style="list-style-type: none"> • system time • show system time • system set-manual-time

Enabling or Disabling the Portal Access

The Cisco Enterprise NFVIS portal access is enabled by default. You can disable the access if required.

To disable the portal access:

```
configure terminal
system portal access disabled
commit
```



Note You can enable the portal access using the **enable** keyword with the **system portal access** command.

Verifying the Portal Access

Use the **show system portal status** command to verify the portal access status as shown below:

```
nfvis# show system portal status
system portal status "access disabled"
```

Portal Access APIs and Commands

Portal Access APIs	Portal Access Commands
<ul style="list-style-type: none"> • /api/config/system/portal • /api/operational/system/portal/status 	<ul style="list-style-type: none"> • system portal access • show system portal status

Configuring System Logs

You can view system logs for troubleshooting purpose. There are two log types and five log levels. The two log types are configuration and operational.

The INFO and WARNING log levels are set by default respectively for the configuration and operational log types. You can change them as required. However, the change to the log level is not persisted across a reboot. After a reboot, the default log levels are used.

The following table explains the log levels:

Log Level	Purpose
DEBUG	Information, typically of interest only when diagnosing problems.
INFO	Confirmation that things are working as expected.
WARNING	An indication that something unexpected happened, or indicative of some problem in the near future (for example, 'disk space low'). The software application is still working as expected.
ERROR	Due to a serious problem, the software application is not able to perform some function.
CRITICAL	A serious error, indicating that the program itself may not be able to continue running.

You can configure system logs using the **system set-log** command in global configuration or privileged EXEC mode:

```
system set-log level error logtype configuration
```

Verifying the System Log Configuration

To verify the system log configuration, use the **show system logging-level** command as shown below:

```

nfvis# show system logging-level
system logging-level configuration error
system logging-level operational warning

```

System Log APIs and Commands

System Log APIs	System Log Commands
<ul style="list-style-type: none"> • /api/operations/system/set-log • /api/operational/system/logging-level 	<ul style="list-style-type: none"> • system set-log logtype [all/configuration/operational] level [critical/debug/error/info/warning] • show system logging-level

Network File System Support

The Network File System (NFS) is an application where the user can view, store and update the files on a remote device. NFS allows the user to mount all or a part of a file system on a server. NFS uses Remote Procedure Calls (RPC) to route requests between the users and servers.

NFS Mount and Unmount

To mount NFS:

```

configure terminal
system storage nfs_storage
nfs
100
10.29.173.131
/export/vm/amol
commit

```

To unmount NFS use **no system storage nfs_storage** command.

Image Registration on NFS

Images in tar.gz, ISO and qcow2 format, remote images and images on mounted NFS can be registered on NFS.

To register tar.gz images on NFS:

```

configure terminal
vm_lifecycle images image myas10 src file:///data/mount/nfs_storage/repository/asav961.tar.gz
properties property placement value nfs_storage
commit

```

Similar configuration can be used for the various images formats.

To unregister an image from NFS use **no vm_lifecycle images** command.

Deploy VM on NFS

To deploy a VM on NFS, under deployment vm group use **placement type zone_host host nfs_storage** command.

Secure Boot of host



Note This feature is supported only on ENCS 5400. Upgrade BIOS to version 2.6 for this feature. The secure boot feature is only available for release 3.9.1 fresh install.

The secure boot feature prevents malicious software applications and unauthorized operating systems from loading into the system during the system start up process. If secure boot feature is enabled, only the authorized software applications boots up from the device. Each device has keys that allow software with the correct signature to boot up on the device.

This feature ensures that the software applications that boot up on the device are certified by Cisco. The NFVIS 3.9.1 image is signed with Cisco key. If secure boot is enabled the signature is verified during the device boot up. If the verification fails, the image does not boot up.

Secure boot is disabled by default and to enable it you must change firmware configurations from CIMC. Secure boot needs to boot from a separate UEFI partition.

To enable secure boot:

1. Get into CIMC and use **show bios detail** command to view the BIOS version.

```
ENCS# scope bios
ENCS/bios # show detail
BIOS:
  BIOS Version: " ENCS54_2.6 (Build Date: 07/12/2018)"
  Boot Order: EFI
  FW Update/Recovery Status: Done, OK
  Active BIOS on next reboot: main
  UEFI Secure Boot: disabled
ENCS/bios #
```

2. enable secure boot.

```
ENCS/bios # set secure-boot enable
Setting Value : enable
Commit Pending.
ENCS/bios *# commit
ENCS/bios # show detail
BIOS:
  BIOS Version: "ENCS54_2.6 (Build Date: 07/12/2018)"
  Boot Order: EFI
  FW Update/Recovery Status: None, OK
  Active BIOS on next reboot: main
  UEFI Secure Boot: enabled
ENCS/bios #
```

Legacy boot, UEFI boot and UEFI secure boot are the three boot modes. Secure boot can only be used on a disk that has UEFI partition.

You can configure boot order from CIMC command or portal or from BIOS setup menu. With CIMC you can only configure legacy boot order. BootOrderRules are by default set to Strict and so boot order follows the CIMC configuration. Since CIMC cannot be used to configure UEFI boot order, the BootOrderRules setting must be changed to Loose when secure boot is enabled.

If BootOrderRules is set to Loose, the boot order will follow the BIOS setup menu. When an operating system is installed in secure boot mode, the new UEFI boot option for the OS automatically appears at the top of the BIOS menu boot order list, to boot the installed operating system.

To set BootOrderRule to Loose:

```
ENCS/bios # scope advanced
ENCS/bios/advanced # set BootOrderRules Loose
ENCS/bios/advanced *# commit
Changes to BIOS set-up parameters will require a reboot.
Do you want to reboot the system?[y|N]y
```

CIMC Control

On ENCS 5400, NFVIS administrators have authoritative control of the device. This includes capability to change the IP address used to reach the CIMC and modifying the CIMC and BIOS passwords

CIMC Access using NFVIS



Note CIMC access using NFVIS is supported only on ENCS 5400.

When CIMC access is enabled on NFVIS, there is a potential risk of unauthorized ISRV to gain access to the host CIMC and switch management console. You must have authorization from CID or Consent token to gain root access.

To access CIMC using NFVIS WAN or management interface IP address, use the **system settings cimc-access enable** command. Once you configure CIMC access on NFVIS, the stand alone CIMC access using CIMC IP address is disabled and you will be able to access CIMC using NFVIS management interface IP address. The configurations remain on the device even after the device reboot.

When the CIMC access is configured, it enables a few ports to access services like SSH, SNMP, HTTP and HTTPS into the CIMC.

The following port numbers are being used for forwarding services to CIMC:

- 20226 for SNMP
- 20227 for SSH
- 20228 for HTTP
- 20229 for HTTPS

If you are unable to access CIMC using NFVIS, check the show log nfvis_config.log file.

Use **system settings cimc-access disable** to disable this feature.

BIOS-CIMC Update

Starting from 3.8.1 release, for ENCS 5400 router, if existing BIOS/CIMC version is lower than the bundled image in 3.8.1 NFVIS package, it is updated automatically during the NFVIS upgrade or installation. Also the CPU microcode is upgraded. The upgrade time takes longer than the previous releases and the upgrade will be done automatically, and you cannot stop the process once it is initiated.

For ENCS 5100 router, BIOS will be upgraded automatically to a new version but you need to boot up the server manually after the upgrade.

NFVIS Password Recovery

1. Load the NFVIS 3.9.1 image, using the CIMC KVM console.
2. Select Troubleshooting from the Boot Selection menu.
3. Select Rescue a NFVIS Password.
4. Select Continue.
5. Press Return to get a shell.
6. Run the **chroot /mnt/sysimage** command.
7. Run the **./nfvis_password_reset** command to reset the password to admin.
8. Confirm the change in password and enter Exit twice.
Remove the CD-ROM and reboot NFVIS.
9. Login to NFVIS with the default credentials admin/Admin123#.
After login to NFVIS, enter a new password at prompt.
10. Connect to NFVIS with the new password.



Note You can update and recover NFVIS 3.8.1 and older passwords using NFVIS 3.9.1.

DPDK Support on NFVIS

The Data Plane Development Kit (DPDK) is a set of data plane libraries and network interface controller drivers for fast packet processing.

DPDK Support for NFVIS 3.10.x

DPDK support is enabled only on ENCS 5400 from NFVIS 3.10.1 release. To enable DPDK use **system settings dpdk enable** command. Once DPDK is enabled it cannot be disabled. You can use **factory-default-reset all-except-images-connectivity** to disable DPDK.

To enable DPDK support:

```
configure terminal
system settings dpdk enable
commit
```

DPDK can be enabled if:

- No VMs are deployed.
- There are no other bridges created other than the default bridge which is wan-br, wan2-br or lan-br.
- The default bridges are not modified.

DPDK mode is enabled on a bridge, if the bridge is created as part of a network or bridge api without any NIC ports. NIC ports can also be added later to the bridge, if no VMs are deployed on the network associated to the bridge. If a NIC port is added to the bridge, the bridge will switch to non-dpdk mode. Once a bridge enters non-dpdk mode, it will not switch back to DPDK mode again. NFVIS supports DPDK for the interface with virtio driver only.



Note NFVIS 3.10.x release does not support **tcpdump packetcapture** command on DPDK enabled bridge.

If DPDK is enabled, all VMs deployed will have DPDK and HugePage support. The default hugepage size is 2MB. After DPDK is enabled the system reserves 512 hugepages for Openvswitch operations. Hugepages for VM are allocated dynamically. If the system is not able to allocate HugePages for a newly deployed VM, the VM will boot up in error state. Memory Fragmentation is the main reason why HugePage allocation fails. In this case a reboot can help solve the issue.



Note DPDK support is only enabled on the bridges without NIC ports.

For a system without Hyper-threading one additional core is reserved by the system and for a system with Hyper-threading two additional logical cores are reserved by the system.

NFVIS does not support changing Hyper-thread option such as disabling after DPDK is enabled with Hyper-thread. The system can be unstable if you change Hyper-thread setting after DPDK is enabled.

DPDK VM Migration for NFVIS 3.11.x

Enhancements to DPDK Support in NFVIS 3.12.x

Service Bridge DPDK Support for New Platforms

Starting from NFVIS 3.12.1 DPDK support is added for service bridges on UCS-C M5, UCS-E M3 and CSP 5000 series. Only the service bridge is supported and the default wan bridge and lan bridge do not support DPDK feature. DPDK is supported on service bridge with or without any pnics. The configuration for service bridge without any pnics is the same as ENCS platform on NFVIS 3.11.1 release, all service bridges will become dpdk-capable after DPDK is enabled. NFVIS system does not require reboot after DPDK is enabled.

DPDK and SR-IOV cannot co-exist on the pnics used for DPDK-capable bridge. The configuration for service bridge with pnics is as followed:

1. (Optional) If pnic ethX-Y is still attached to lan-br, remove it from lan-br.

```
configure terminal
bridges bridge lan-br
no port ethX-Y
commit
```

2. Remove SR-IOV networks associated with ethX-Y (usually ethX-Y-SRIOV-*).

```
configure terminal
no networks network ethX-Y-SRIOV-1
no networks network ethX-Y-SRIOV-2
...
commit
```

3. Disable ethX-Y SRIOV configuration.

```
configure terminal
pnic ethX-Y
no sriov
nnumvf 0
commit
```

4. Create service bridge with port ethX-Y.

```
configure terminal
bridges bridge service-br port ethX-Y
networks network service-net bridge service-br
commit
```

5. Enable system-wide DPDK setting.

```
configure terminal
system settings dpdk enable
commit
```



Note

- You can also enable DPDK before creating service bridge with port ethX-Y.
 - Except ENCS 5400 platform, all default bridges (lan-br, wan-br, wan-br2) does not enter DPDK-mode after DPDK is enabled system-wide.
 - If you do not remove SR-IOV configuration from pnic ethX-Y, and ethX-Y is a port of service bridge, this service bridge cannot enter DPDK-mode after DPDK is enabled system-wide. If you have to use pnic ethX-Y in DPDK bridge, after removing SR-IOV configuration from ethX-Y, delete old bridge and create new bridge and attach ethX-Y to the new bridge.
-

Migration for VMs with PNIC associated to DPDK bridge

If DPDK is enabled, all VMs deployed will have DPDK and HugePage support. The default hugepage size is 2MB. After DPDK is enabled, the system will reserve additional 512~2048 contiguous hugepages for DPDK operations. Though hugepages for VM are allocated dynamically, it will cause memory fragmentation and the main reason DPDK enabling process will fail. In this case, a system reboot might help to solve the issue.

If system can find enough hugepages for DPDK process, not only service bridges will enter DPDK-mode, all VMs' vnic attached to those bridges will be migrated from virtio to dpdk type (dpdkvhostuserclient):

```

nfvis# support ovs vsctl show | begin service-br
  Bridge service-br
    Port "vnic2"
      Interface "vnic2"
        type: dpdkvhostuserclient
        options: {vhost-server-path="/run/vhostfd/vnic2"}
    Port service-br
      Interface service-br
        type: internal

nfvis# support virsh dumpxml ROUTER | begin interface | until serial
<interface type='network'>
  <mac address='52:54:00:ae:14:57'/>
  <source network='wan-net'/>
  <target dev='vnic1'/>
  <model type='virtio'/>
  <address type='pci' domain='0x0000' bus='0x00' slot='0x04' function='0x0'/>
</interface>
<interface type='vhostuser'>
  <mac address='52:54:00:3d:ee:1a'/>
  <source type='unix' path='/run/vhostfd/vnic2' mode='server'/>
  <target dev='vnic2'/>
  <model type='virtio'/>
  <address type='pci' domain='0x0000' bus='0x00' slot='0x05' function='0x0'/>
</interface>

```

DPDK and Factory Reset

The three commonly-used factory reset configurations disable DPDK.

Factory-default-reset configuration	DPDK enabled	Networks kept	Deployment deleted	Registered image deleted
all	No	No	Yes	Yes
all-except-images	No	No	Yes	No
all-except-images-connectivity	No	Yes	Yes	No

Frequently Seen Failures

- Error when DPDK is enabled.
 - When enabling DPDK, lack of system memory results in an error. Ensure that you have 4 GB contiguous HugePages to enable DPDK. You can also reboot the system.
 - DPDK requires one physical core from each socket. A multi-sockets system (like UCS-C or CSP) can encounter deployments that occupy all cores on one socket and DPDK can fail to enable. Power-off some VM (resource-locking VMs likes ISRv/ASAv/vWAAS) and enable VM after DPDK is enabled successfully.
- If the system is not able to allocate HugePages for a newly deployed VM, the VM will boot up in error state.

Import and Export NFVIS VM

Starting from NFVIS 3.10.1 release, you can backup or export (vmExportAction) and restore or import (vmImportAction) VMs. To backup or restore the whole NFVIS system, refer Backup and Restore NFVIS and VM Configurations.

VM Export and Import Limitations

- The imported VM cannot change datastore.
- The original registered image must exist.
- The OVS network name must be identical to the one used by original deployment.
- NFVIS does not check the disk space before exporting or importing a VM.
- The VM has larger disk footprint compared to original deployment after exporting or importing.

To export a VM ensure that:

- VM is in powered off state.
- Backup file is saved in any NFVIS datastores or USB.
- Provide a backup name for NFVIS to append .vmbkp extension to the backup name.

You can only create and save a VM backup to datastores. The backup file has .bkup extension. To verify the backup:

```
nfvis# show system file-list disk local | display xpath | include backup
/system/file-list/disk/local[si-no='84']/name tiny_backup.vmbkp
nfvis# show system file-list disk local 84
SI NO NAME PATH SIZE TYPE DATE MODIFIED
-----
84 tiny_backup.vmbkp /mnt/extdatastore1 17M VM Backup Package 2019-01-31 19:31:32
```

To import a VM ensure that:

- The Backup file is placed under NFVIS datastores or USB.
- The registered image used by the original deployed VM is in the same datastore, with same properties.
- The Original deployed VM does not exist on the system.
- OVS network used by the original deployment should exist.
- Restored VM is created with the same datastore with same deployment properties.
- The full path name to backup file is used (for example, /mnt/extdatastore1/backup.vmbkp, not extdatastore1.backup)

```
nfvis# vmImportAction importPath /mnt/extdatastore1/tiny_backup.vmbkp
System message at 2019-01-31 19:53:32...
```

Commit performed by admin via ssh using maapi.

The following examples show export failures:

- Original deployment is not deleted

```
nfvis# vmImportAction importPath /mnt/extdatastore1/tiny_backup.vmbkp
Error: Exception from action callback: Deployment Configuration :
'SystemAdminTenantIdtiny' already exists , can not be imported/restored due to conflict!
```

- 2. OVS network used by original deployment is deleted.

```
nfvis# vmImportAction importPath /mnt/extdatastore1/tiny_backup.vmbkp
Error: Exception from action callback: Restoration Request rejected, see logs for root
cause
```

Backup and Restore NFVIS and VM Configurations

Starting from NFVIS 3.10.1 release, you can backup and restore NFVIS configurations and VMs. You can also restore a backup from one NFVIS device to another if they are running on the same version of NFVIS and have the same platform.



Note To backup or restore a single VM, use `vmImportAction` and `vmBackupAction` APIs.

To backup and save NFVIS and all VM configurations use `configuration-only` option. To backup and save VM disks, NFVIS and VM configurations use `configuration-and-vms` option.

You can only create a backup to datastore or uploads directory. The backup file has `.bkup` extension.

The following examples shows the backup options:

```
nfvis# hostaction backup configuration-and-vms file-path intdatastore:sample.bkup
```

```
nfvis# hostaction backup configuration-only file-path extdatastore2:sample-dir/sample.bkup
```

The following example shows the backup stored on a USB:

```
nfvis# hostaction backup configuration-only file-path usb:usb1/sample.bkup
```

Use `hostaction backup force-stop` command to stop the running backup.

To restore a previous backup on same NFVIS setup or on a new NFVIS setup use `except-connectivity` option which preserves connectivity of the NFVIS and restores everything else from backup.

```
nfvis# hostaction restore file-path intdatastore:sample.bkup
```

The following example shows how to restore a backup on a different NFVIS device:

```
nfvis# hostaction restore except-connectivity file-path extdatastore2:sample-dir/sample.bkup
```

Backup, Restore and Factory-Default-Reset

To restore the system after factory-default-reset using backup or restore, check:

- Backup file location:
 - The system backup bundle is saved under */datastore/uploads/* by default.
 - Factory-default-reset cleans up all files under */datastore/uploads/*, but leave files under */datastore/* intact.
 - To restore the system from backup bundle after factory-default-reset, if the backup bundle is saved on any other location, the minimum requirement is to have a connection to the NFVIS to upload the backup bundle.
- VM restoration if system backup contains VM backups:
 - VM restoration requires the original image or template registered in NFVIS.
 - Factory-default-reset all clean ups all registered images and uploaded files. You need to configure minimum setup, like host connection and upload registered images to the same datastore.

To save backup bundle from factory-default-reset:

- Save the backup bundle in remote locations. Then restore the connectivity and upload the backup bundle after reset.
- Save backup bundle in local */datastore/* and not in */datastore/uploads/*:

```
# Backup & Restore on the same NFVIS box without NFS & USB
# [[ BACKUP ]]
# before executing factory-default-reset

nfvis# nfvis# hostaction backup configuration-only file-path
extdatastore1:configBackup-01.bkup
nfvis# system file-copy source /mnt/extdatastore1/uploads/configBackup-01.bkup destination
/mnt/extdatastore2/

# after factory-default-reset all-except-images or all-except-images-connectivity,
# file /mnt/extdatastore1/uploads/configBackup-01.bkup will be deleted
# but /mnt/extdatastore2/configBackup-01.bkup won't.

# [[RESTORE]]
# after NFVIS rebooted and login to console, copy file to uploads/ directory

nfvis# system file-copy source /mnt/extdatastore2/configBackup-01.bkup destination
/mnt/extdatastore2/uploads/
nfvis# hostaction restore file-path extdatastore2:configBackup-01.bkup
```

For VM restoration:

- Use *all-except-images* and *all-except-images-connectivity* to keep registered images intact.

- Save the configurations of existing image registrations before running factory-default-reset all. Save the customized flavors or profiles if you have them which can be used as reference after factory-default-reset all.

Dynamic SR-IOV

Dynamic SR-IOV allows you to enable or disable SR-IOV on a Physical Network Interface Controller (PNIC). You can disable SR-IOV on any PNIC to 0 and enable SR-IOV by setting a value between 1 to maximum virtual functions (maxvfs) supported on PNICs. You can also create and delete SR-IOV networks based on the number of virtual functions (numvfs) set on that PNIC while enabling SR-IOV. Existing fresh installation behavior has not changed. Each PNIC has default number of VFs created and Default SRIOV networks are created. User can use CLI, API or GUI to Enable/Disable SR-IOV on a PNIC or to Create/Delete SR-IOV networks

Restrictions or Limitations

- The supported platforms are CSP-2100, CSP-5000, UCSc-C220-M5X and UCS-E-M3.
- Dynamic SR-IOV is not supported on certain PNICs:
 - PNIC with driver i40e
 - PNIC that does not support SRIOV
- Only switch mode VEB is supported for NFVIS 3.12.1 release.
- Resizing the number of virtual functions is not supported. SR-IOV should be disabled and then enabled with desired number of virtual functions.

Disable SR-IOV on a PNIC

All SR-IOV networks for a PNIC must be deleted. PNIC should not be attached to a bridge.

```
configure terminal
no pnic eth0-1 sriov
commit
```

Enable SR-IOV on a PNIC

To enable SR-IOV on a PNIC, it has to support SR-IOV, numvfs field should be less than maximum supported VFs (maxvfs) on a PNIC and PNIC should not be attached to a bridge.

```
configure terminal
pnic eth0-1 sriov numvfs 20
commit
```

To display SR-IOV state of all PNICs use **show pnic sriov** command. To display SR-IOV state of individual PNIC use **show pnic eth0-1 sriov** command.

Creation of SR-IOV Networks

To create SR-IOV networks, PNIC must have SRIOV enabled and configured with numvfs. The SRIOV network name must have the following format: <pnic_name>-SRIOV-<num> with <pnic_name> as a valid PNIC name and <num> must be greater than 0 and less than numvfs.

To create SR-IOV network in trunk mode:

```
configure terminal
networks network eth0-1-SRIOV-1 sriov true
commit
```

To create SR-IOV network in access mode:

```
configure terminal
networks network eth0-1-SRIOV-1 sriov true trunk false vlan 30
commit
```

Delete SR-IOV Networks

To delete SR-IOV networks VM should not be attached to the network.

```
configure terminal
no networks network eth0-1-SRIOV-1
commit
```

To verify the system networks use **show system networks** command.



CHAPTER 4

Cisco Network Plug-n-Play Support



Note Starting from 3.10.1 release, NFVIS is integrated with PnP 1.8.

The Cisco Network Plug and Play (Cisco Network PnP) solution provides a simple, secure, unified, and integrated offering for enterprise network customers to ease new branch or campus device rollouts, or for provisioning updates to an existing network. The solution provides a unified approach to provision enterprise networks comprising Cisco routers, switches, and wireless devices with a near zero touch deployment experience. This solution uses Cisco Application Policy Infrastructure Controller Enterprise Module (APIC-EM) to centrally manage remote device deployments.

Currently, you can use the Cisco Network Plug and Play client to:

- Auto discover the server
- Provide device information to the server
- Bulk provisioning of user credentials

Bulk Provisioning of User Credentials

You can change the default user name and password of the devices using the Cisco Network PnP client. The Cisco Network PnP server sends the configuration file to Cisco Network PnP clients residing on multiple devices in the network, and the new configuration is automatically applied to all the devices.



Note For bulk provisioning of user credentials, ensure that you have the necessary configuration file uploaded to the Cisco APIC-EM. The following are the supported configuration formats:

Sample Format 1

```
<config xmlns="http://tail-f.com/ns/config/1.0">
  <rbac xmlns="http://www.cisco.com/nfv/rbac">
    <authentication>
      <users>
        <user>
          <name>admin</name>
          <password>Cisco123#</password>
        </user>
      </users>
    </authentication>
  </rbac>
</config>
```

```

        <role>administrators</role>
    </user>
    <user>
        <name>test1</name>
        <password>Test1239#</password>
        <role>administrators</role>
    </user>
    <user>
        <name>test2</name>
        <password>Test2985#</password>
        <role>operators</role>
    </user>
</users>
</authentication>
</rbac>
</config>

```

Sample Format 2

If you use format 2, the system will internally convert this format into format 1.

```

<aaa xmlns="http://tail-f.com/ns/aaa/1.1">
  <authentication>
    <users>
      <user>
        <name>admin</name>
        <password>User123#</password>
      </user>
    </users>
  </authentication>
</aaa>

```

For more details on the Cisco Network PnP solution and how to upload a configuration file, see the [Configuration Guide for Cisco Network Plug and Play on Cisco APIC-EM](#).

- [PnP Discovery Methods, on page 50](#)
- [Configuring PnP Discovery Methods, on page 51](#)
- [PnP Action, on page 54](#)

PnP Discovery Methods

When a device is powered on for the first time, the Cisco Network PnP agent discovery process, which is embedded in the device, wakes up in the absence of the startup configuration file, and discovers the IP address of the Cisco Network PnP server located in the Cisco APIC-EM. The Cisco Network PnP agent uses the following discovery methods:

- **Static IP address**—The IP address of the Cisco Network PnP server is specified using the **set pnp static ip-address** command.
- **DHCP with option 43**—The Cisco PnP agent automatically discovers the IP address of the Cisco Network PnP server specified in the DHCP option 43 string. For more details on how to configure DHCP for APIC-EM controller auto-discovery, see the [Solution Guide for Cisco Network Plug and Play](#)
- **Domain Name System (DNS) lookup**—If DHCP discovery fails to get the IP address of the APIC-EM controller, for example, because option 43 is not configured, the Cisco Plug and Play Agent falls back on a DNS lookup method. Based on the network domain name returned by the DHCP server, it constructs a fully qualified domain name (FQDN) for the APIC-EM controller, using the preset hostname "pnpserver".

For more details on how to configure DNS for APIC-EM controller auto-discovery, see the [Solution Guide for Cisco Network Plug and Play](#).



Note DNS lookup method is not supported in 3.10.1 release.

- Cloud Redirection—This method uses the Cisco Cloud Device Redirect tool available in the [Cisco Software Central](#). The Cisco Plug and Play Agent falls back on the Cloud Redirection method if DNS lookup is not successful.

Configuring PnP Discovery Methods

To enable static mode for PnP discovery using IPv4:

```
configure terminal
pnp automatic dhcp disable
pnp automatic dns disable
pnp automatic cco disable
pnp static ip-address 192.0.2.8 port 80
commit
```

To enable static mode for PnP discovery using IPv6:

```
configure terminal
pnp automatic dhcp-ipv6 disable
pnp automatic dns-ipv6 disable
pnp automatic cco-ipv6 disable
pnp static ipv6-address 192.0.2.8 port 80
commit
```



Note Either IPv4 or IPv6 can be enabled at a time.

To enable static mode for PnP discovery using FQDN:

```
configure terminal
pnp static ip-address apic-em-fqdn.cisco.com port 80 transport http
commit
```



Note In FQDN support for PnP, domain names can be specified as an input. FQDN that is configured with IPv6 on a DNS server is not supported.

To enable automatic mode for PnP discovery using IPv4:



Note By default, the automatic discovery mode for DHCP, DNS, and CCO is enabled. You can enable or disable the options as required. For example, you can enable all options or keep one enabled, and the rest disabled.

```
configure terminal
pnp automatic dhcp enable
pnp automatic dns enable
pnp automatic cco enable
pnp automatic timeout 100
commit
```

To enable automatic mode for PnP discovery using IPv6:

```
configure terminal
pnp automatic dhcp-ipv6 enable
pnp automatic dns-ipv6 enable
pnp automatic cco-ipv6 enable
pnp automatic timeout 30
commit
```



Note You cannot disable both static and automatic PnP discovery modes at the same time. You must restart PnP action every time you make changes to the PnP discovery configuration. You can do this using the **pnp action command restart**.

Verifying the PnP Status

Use the **show pnp** command in privileged EXEC mode to verify the configuration of PnP discovery methods. The following sample output shows that the static discovery mode is enabled, and the automatic discovery mode is disabled.

```
nfvis# show pnp
pnp status response "PnP Agent is running\n"
pnp status ip-address 192.0.2.8
pnp status port 80
pnp status transport ""
pnp status created_by user
pnp status dhcp_opt43 0
pnp status dns_discovery 0
pnp status cco_discovery 0
pnp status timeout 100
nfvis#
```

FQDN

```
nfvis# show pnp
pnp status response "PnP Agent is running\nserver-connection\n status: Success\n time:
19:59:38 Feb 27\nbackoff\n status: Success\n time: 19:59:38 Feb 27\n"
pnp status ip-address apic-em-fqdn.cisco.com
pnp status ipv6-address ""
pnp status port 443
pnp status transport https
pnp status cafile /etc/pnp/certs/trustpoint/pnplabel
pnp status created_by user
pnp status dhcp_opt43 0
pnp status dns_discovery 0
```

```

pnp status cco_discovery 0
pnp status dhcp-ipv6 0
pnp status dns-ipv6 0
pnp status cco-ipv6 0
pnp status timeout 0
nfvis#

```

The following sample output shows that the static discovery mode is disabled, and the automatic discovery mode is enabled for DHCP, DNS, and CCO:

DHCP:

```

nfvis# show pnp
pnp status response "PnP Agent is running\ncli-exec\n      status: Success\n      time: 18:30:57
  Apr 21\nserver-connection\n      status: Success\n      time: 15:40:41 Apr
  22\ncertificate-install\n      status: Success\n      time: 18:31:03 Apr 21\ndevice-auth\n
  status: Success\n      time: 18:31:08 Apr 21\nbackoff\n      status: Success\n      time: 15:40:41
  Apr 22\n"
pnp status ip-address 192.0.2.8
pnp status port 443
pnp status transport https
pnp status cafile /etc/pnp/certs/trustpoint/pnplabel
pnp status created_by dhcp_discovery
pnp status dhcp_opt43 0
pnp status dns_discovery 0
pnp status cco_discovery 0
pnp status timeout 60

```

DNS:

```

nfvis# show pnp
pnp status response "PnP Agent is running\ncli-exec\n      status: Success\n      time: 17:18:42
  Apr 22\nserver-connection\n      status: Success\n      time: 17:20:00 Apr
  22\ncertificate-install\n      status: Success\n      time: 17:18:47 Apr 22\ndevice-auth\n
  status: Success\n      time: 17:18:53 Apr 22\nbackoff\n      status: Success\n      time: 17:20:00
  Apr 22\n"
pnp status ip-address 192.0.2.8
pnp status port 443
pnp status transport https
pnp status cafile /etc/pnp/certs/trustpoint/pnplabel
pnp status created_by dns_discovery
pnp status dhcp_opt43 0
pnp status dns_discovery 0
pnp status cco_discovery 0
pnp status timeout 60

```

CCO:

```

nfvis# show pnp
pnp status response "PnP Agent is running\ncli-exec\n      status: Success\n      time: 17:18:42
  Apr 22\nserver-connection\n      status: Success\n      time: 17:20:00 Apr
  22\ncertificate-install\n      status: Success\n      time: 17:18:47 Apr 22\ndevice-auth\n
  status: Success\n      time: 17:18:53 Apr 22\nbackoff\n      status: Success\n      time: 17:20:00
  Apr 22\n"
pnp status ip-address 192.0.2.8
pnp status port 443
pnp status transport https
pnp status cafile /etc/pnp/certs/trustpoint/pnplabel
pnp status created_by cco_discovery
pnp status dhcp_opt43 0
pnp status dns_discovery 0
pnp status cco_discovery 0
pnp status timeout 60

```

PnP Server APIs and Commands

PnP Server APIs	PnP Server Commands
<ul style="list-style-type: none"> • /api/config/pnp • /api/config/pnp?deep 	<ul style="list-style-type: none"> • pnp static ip-address • pnp automatic • show pnp

PnP Action

You can start, stop, and restart any PnP action using the PnP action command or API.

PnP Action API and Command

PnP Action API	PnP Action Command
<ul style="list-style-type: none"> • /api/operations/pnp/action 	<ul style="list-style-type: none"> • pnp action command



CHAPTER 5

VM Life Cycle Management

VM life cycle management refers to the entire process of registering, deploying, updating, monitoring VMs, and getting them service chained as per your requirements. You can perform these tasks and more using a set of REST APIs or NETCONF commands or the Cisco Enterprise NFVIS portal.

VM Packaging Format

All VM images are available in the `.tar.gz/qcow2/vmdk/img/iso` format. All Cisco supplied VMs are available in the prescribed format. Vendors are responsible for packaging all third party VMs in the prescribed format.

- [Workflow of VM Life Cycle Management, on page 55](#)
- [Uploading VM Images to an NFVIS Server, on page 57](#)
- [VM Bootstrap Configuration Options with a VM Deployment, on page 58](#)
- [OpenStack Configuration Drive Support for Third Party VMs, on page 59](#)
- [Performing Resource Verification, on page 60](#)
- [Configuring Management IP Address, on page 61](#)
- [VM States, on page 61](#)

Workflow of VM Life Cycle Management

The following diagram depicts the basic workflow of the VM life cycle management using REST APIs:

Figure 5: VM Life Cycle Management

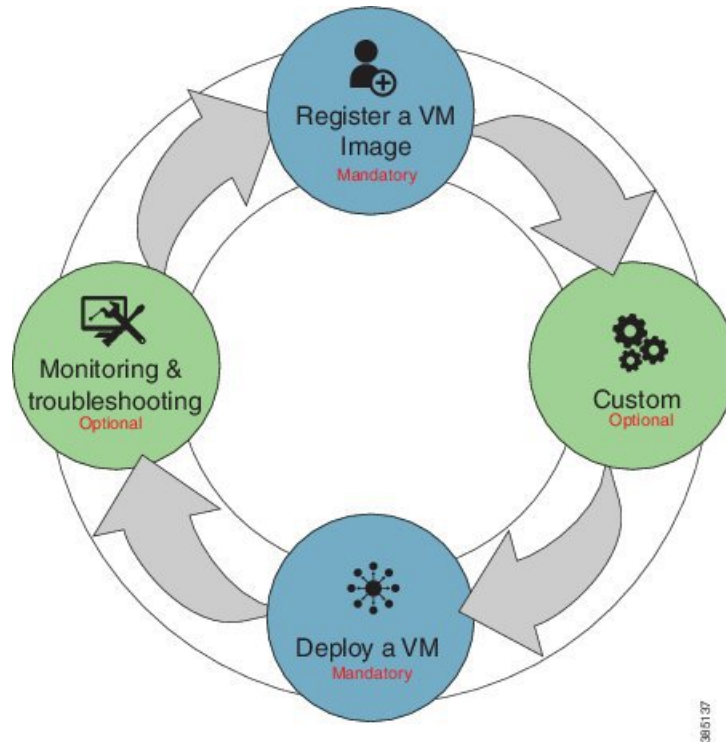

1. **Register a VM Image**—To register a VM image, you must first copy or download the relevant VM image to the NFVIS server, or host the image on a http or https server. Once you have downloaded the file, you can register the image using the registration API. The registration API allows you to specify the file path to the location (on the http/https server) where the tar.gz file is hosted. Registering the image is a one-time activity. Once an image is registered on the http or https server, and is in active state, you can perform multiple VM deployments using the registered image.
2. **Customizing the Setup**—After registering a VM image, you can optionally create a custom profile or flavor for the VM image if the profiles defined in the image file do not match your requirement. The flavor creation option lets you provide specific profiling details for a VM image, such as the virtual CPU on which the VM will run, and the amount of virtual memory the VM will consume.

Depending on the topology requirement, you can create additional networks and bridges to attach the VM to during deployment.

3. **Deploy a VM**— A VM can be deployed using the deployment API. The deployment API allows you to provide values to the parameters that are passed to the system during deployment. Depending on the VM you are deploying, some parameters are mandatory and others optional.
4. **Manage and Monitor a VM**—You can monitor a VM using APIs and commands that enable you to get the VM status and debug logs. Using VM management APIs, you can start, stop, or reboot a VM, and view statistics for a VM such as CPU usage.

A VM can also be managed by changing or updating its profile. You can change a VM's profile to one of the existing profiles in the image file; alternatively, you can create a new custom profile for the VM.

The vNICs on a VM can also be added or updated.



Note Before performing the VM life cycle management tasks, you will have to upload the VM images to the NFVIS server or http/s server.

For details on APIs, see the [VM Lifecycle Management APIs](#) chapter in the *API Reference for Cisco Enterprise Network Function Virtualization Infrastructure Software*.

Uploading VM Images to an NFVIS Server

You can upload VM images to an NFVIS server in the following ways. The files are copied to the default location (/data/intdatastore/uploads) on the host server.

- Copy the images from your local system to the NFVIS server—Use the **Image Upload** option from the Cisco Enterprise NFVIS portal.
- Copy the images using the USB drive—Ensure that you have plugged the USB drive that contains the required images into the server before mounting the USB drive.
- Copy using the **scp** command (scp username@external_server:/path/image.tar.gz intdatastore:image.tar.gz).



Note From 3.8.1 release, NFVIS supports deleting images while the download is in progress. NFVIS also supports resuming image download after a power outage or lost connectivity.

To copy an image using the USB device:

```
configure terminal
system usb-mount mount ACTIVE
system file-copy usb file name usb1/package/isrv-universalk9.16.03.01.tar.gz
commit
```



Note Use the **show system file-list disk usb** command in privileged EXEC mode to view a list of files available with the mounted USB drive. To save space, you can delete all unwanted text and TAR files from the default location using the **system file-delete** command in global configuration mode.

Verifying the Image Copied from the USB Drive

After copying the file from the USB drive to the host server, you can verify the file using the **show system file-list disk local** command:

```
nfvis# show system file-list disk local
```

SI	NO	NAME	PATH	SIZE	TYPE	DATE	MODIFIED
1		lastlog-20170314.gz	/data/intdatastore/logs/2017-03/14/10-00	337	Other	2017-03-14	21:55:42
2		escmanager-tagged-log.log-20170314.gz	/data/intdatastore/logs/2017-03/14/10-00	167K	Other		

```

2017-01-18 05:58:26
3 confd_audit.log-20170317.gz /data/intdatastore/logs/2017-03/17/09-30 4.6K Other 2017-03-17
  21:29:59
4 esc_postinit.log-20170317.gz /data/intdatastore/logs/2017-03/17/05-00 605K Other 2017-03-17
  16:40:19
5 error.log-20170317.gz /data/intdatastore/logs/2017-03/17/05-00 1.3K Other 2017-03-17
  16:40:15
6 ovs-ctl.log-20170317.gz /data/intdatastore/logs/2017-03/17/12-00 20 Other 2017-03-16
  00:00:01 4:01
!
!
!
62 ovs-ctl.log-20170323.gz /data/intdatastore/logs/2017-03/23/12-00 20 Other 2017-03-22
  00:00:01
63 CentOS-7-x86_64-Everything-1511.ova /data/intdatastore/uploads 1.1G VM 2017-03-15 19:20:03
  Package
64 TinyLinux.tar.gz /data/intdatastore/uploads 17M VM 2017-03-15 18:25:00 Package
65 Cisco-KVM-vWAAS-1300-6.3.0-b98.tar.gz /data/intdatastore/uploads 979M VM 2017-03-15
  19:19:11 Package
66 ubuntu_14.04.3-server-amd64-disk1.tar /data/intdatastore/uploads 527M VM 2017-03-15
  19:20:17.gz Package
67 asav961.tar.gz /data/intdatastore/uploads 164M VM 2017-03-15 18:24:57 Package
68 isrv-universalk9.16.03.01.tar.gz /data/intdatastore/uploads 1.3G VM 2017-03-15 19:19:53

```

Related APIs and Commands

APIs	Commands
<ul style="list-style-type: none"> • /api/operations/system/file-copy/usb/file • /api/config/system/usb-mount 	<ul style="list-style-type: none"> • system file-copy usb file name • system usb-mount mount ACTIVE • system file-delete • show system file-list disk usb • show system file-list disk local

VM Bootstrap Configuration Options with a VM Deployment

You can include the bootstrap configuration (day zero configuration) of a VM in the VM deployment payload in the following three ways:

- Bundle bootstrap configuration files into the VM package—In this method, the bootstrap configuration variables can be tokenized. Token names must be in bold text. For each tokenized variable, key-value pairs must be provided during deployment in the deployment payload.
- Bootstrap configuration as part of the deployment payload—The entire bootstrap configuration is copied to the payload without tokens.
- Bootstrap configuration file in the NFVIS server—In this method, the configuration file is copied or downloaded to the NFVIS server, and referenced from the deployment payload with the filename including full path.

For examples on how to use bootstrap configuration options in the deployment payload, see the [API Reference for Cisco Enterprise Network Function Virtualization Infrastructure Software](#).

OpenStack Configuration Drive Support for Third Party VMs

To enable staging of bootstrap configuration files at the time of a third party VM deployment as per OpenStack standards, the following cloud init format is supported:

```
openstack/content
openstack/content/0000
openstack/content/0001
openstack/latest/meta_data.json
```

In the above sample, the "0000" and "0001" files are the actual bootstrap files from the deployment payload. A third party VM can use the init file to fetch its configuration files.

The following metadata file is used to provide the file path on the configuration drive and reference to the actual bootstrap configuration files.

```
{
  "files": [
    {
      "content_path": "/content/0000",
      "path": "/config/day-0.txt"
    },
    {
      "content_path": "/content/0001",
      "path": "/sample/path/iosxe_config.txt"
    }
  ]
}
```

With this implementation, two copies of the same bootstrap configuration file will be present on the virtual CD-ROM package. The first version at the root (iosxe_config.txt) and the second inside the "openstack/content" folder.

The admin will also have to specify the bootstrap configuration file in the image properties file before packaging the VM.

Example for the Bootstrap Configuration File in the Image Properties File

```
--optimize=OPTIMIZE [REQUIRED] optimized VM: --optimize=true/false;
--root_file_disk_bus=ROOT_FILE_DISK_BUS root disk file type:
--root_file_disk_bus=virtio/ide; default is virtio
--virtual_interface_model=VIRTUAL_INTERFACE_MODEL
--virtual_interface_model=rtl8139; default is none
--thick_disk_provisioning=THICK_DISK_PROVISIONING
--thick_disk_provisioning=true; default is false
--bootstrap_cloud_init_bus_type=BOOTSTRAP_CLOUD_INIT_BUS_TYPE
--bootstrap_cloud_init_bus_type=virtio; default is ide
--bootstrap_cloud_init_drive_type=BOOTSTRAP_CLOUD_INIT_DRIVE_TYPE
--bootstrap_cloud_init_drive_type=disk; default is cdrom
--bootstrap=BOOTSTRAP bootstrap file/s for VM (two parameters required in the format of
dst:src; dst filename including path has to match exactly to what the VM expects;
upto 20 bootstrap files are accepted.)
examples:
--bootstrap ovf-env.xml:file1,ios-xe.txt:file2 for ISRV; both files get mounted at the
```

```

root level on the VM.
--bootstrap day0-config:filename1 for ASAv
--bootstrap
/:bootstrap.xml,/license/lic.txt:license.txt
bootstrap.xml get mounted as bootstrap.xml at root, and license.txt get mounted as
/license/lic.txt.

```



Note If any of the strings in the configuration file has wild characters, wrap the string with this `#[]#` so that the token/key replacement engine does not consider wild characters as key or token, and looks for key value pairs to replace during a VM deployment.

For details on the OpenStack standards, visit <http://docs.openstack.org>.

Performing Resource Verification

Given below are the APIs and commands to perform different types of resource verification:

Task	API	Command
To display CPU information for each CPU or the user specified CPU, and the VMs pinned to the CPU	<ul style="list-style-type: none"> • <code>/api/operational/resources/cpu-info/cpus</code> • <code>/api/operational/resources/cpu-info/cpus/cpu</code> • <code>/api/operational/resources</code> <code>/cpu-info/cpus/cpu/<cpu-id></code> 	<code>show resources cpu-info cpus</code>
To display information on the VMs running in all the physical CPUs or a specific physical CPU in the system	<ul style="list-style-type: none"> • <code>/api/operational/resources/cpu-info/vnfs</code> • <code>/api/operational/resources/cpu-info/vnfs/vnf</code> • <code>/api/operational/resources/cpu-info/vnfs/vnf/</code> <code><deployment_name>.<vm_group_name></code> 	<code>show resources cpu-info vnfs</code>
To get information on the number of CPUs allocated to VMs and the CPUs that are already used by the VMs	<code>/api/operational/resources/cpu-info/allocation</code>	<code>show resources cpu-info allocation</code>



Note To display information on all CPUs, VMs pinned to the CPUs, and VMs allocated to the CPUs, use the **show resources cpu-info** command.

CPU Over-Subscription

Cisco Enterprise NFVIS does not allow CPU over-subscription for low-latency network appliance VMs (for example, Cisco ISRV and Cisco ASAv). However, the CPU over-subscription is allowed for non low-latency VMs (for example, Linux Server VM and Windows Server VM).

Configuring Management IP Address

The following commands need to be executed in a sequence to first delete an existing subnet and then add a new subnet in the network. For these commands to work, ensure there is no managed VNF's in the system before you change management network address.

To delete an existing subnet use **no vm_lifecycle networks network int-mgmt-net subnet int-mgmt-net-subnet** command.

To create a new subnet:

```
configure terminal
vm_lifecycle networks network int-mgmt-net subnet int-mgmt-net-subnet address 105.20.0.0
gateway 105.20.0.1 netmask 255.255.255.0 dhcp false
commit
```

VM States

VM States	Description
VM_UNDEF_STATE	The initial state of VM or VNF before deployment of this VM.
VM_DEPLOYING_STATE	VM or VNF is being deployed on to the NFVIS.
VM_MONITOR_UNSET_STATE	VM or VNF is deployed in the NFVIS but the monitoring rules are not applied.
VM_MONITOR_DISABLED_STATE	Due to a VM action request or recovery workflow, the monitoring or KPI rules applied on the VM or VNFs were not enabled.
VM_STOPPING_STATE	VM or VNF is being stopped.
VM_SHUTOFF_STATE	VM or VNF is in stopped or shutoff state.
VM_STARTING_STATE	VM or VNF is being started.
VM_REBOOTING_STAT	VM or VNF is being rebooted.
VM_INERT_STATE	VM or VNF is deployed but not alive. The KPI monitor is applied and waiting for the VM to become alive.
VM_ALIVE_STATE	VM or VNF is deployed and successfully booted up or alive as per the monitor or kpi metric.
VM_UNDEPLOYING_STATE	VM or VNF is being undeployed or terminated.
VM_ERROR_STATE	VM or VNF will be in error state if deployment or any other operation is failed.



CHAPTER 6

VM Deployment Scenarios

This chapter provides details on the following deployment scenarios using REST APIs. As an example, the Cisco ENCS is used to illustrate these scenarios.

- Single VM deployment
- Service chaining with two VMs
- Service chaining of multiple VMs with Windows or Linux servers

The following VM images are used to explain the deployment scenarios:

- Cisco Integrated Services Router (ISRV) —isrv-03.16.02
 - Cisco Adaptive Security Virtual Appliance (ASAv)— asav951-201
 - Linux server—ubuntu-14.04.3-server-amd64-disk1
-
- [Registering VM Images, on page 63](#)
 - [Service Chaining of VMs, on page 67](#)

Registering VM Images

You must register all VM images before deploying them.



Note Register all the VM images required for the VM deployment depending on the topology. A VM image registration is done only once per VM image. You can perform multiple VM deployments using the registered VM image.

To register a Cisco ISRV image:

1. Set up the http/https server to host the VM image, or upload the image to the NFVIS server using the local portal or the **scp** command.
2. Register the Cisco ISRV image using the following API method:

```
curl -k -v -u admin:admin -H Accept:application/vnd.yang.data+xml -H  
Content-Type:application/vnd.yang.data+xml -X
```

```
POST https://<NFVIS_IP>/api/config/vm_lifecycle/images -d
'<image><name>isrv-k9.16.03.01</name><src>http://filename_with_full-path-of
the-file/isrv-universalk9.16.03.01.tar.gz</src></image>'
```

- Verify the image status using the following API method:

```
curl -k -v -u admin:admin -H Accept:application/vnd.yang.data+xml -H
Content-Type:application/vnd.yang.data+xml -X
GET
https://<NFVIS_IP>/api/operational/vm_lifecycle/opdata/images/image/isrv-9.16.03.01?deep
```

- Now, repeat Steps 1 to 3 to register the Cisco ASAv and Linux server images. Ensure that you provide the exact image name and source file location when running the API commands.



Note You can run API commands from any console/server that can reach Cisco Enterprise NFVIS.

Single VM Deployment

In this example, a Cisco ISRV image with three network interfaces is deployed. The following diagram illustrates the deployment topology:

Figure 6: Single VM Deployment

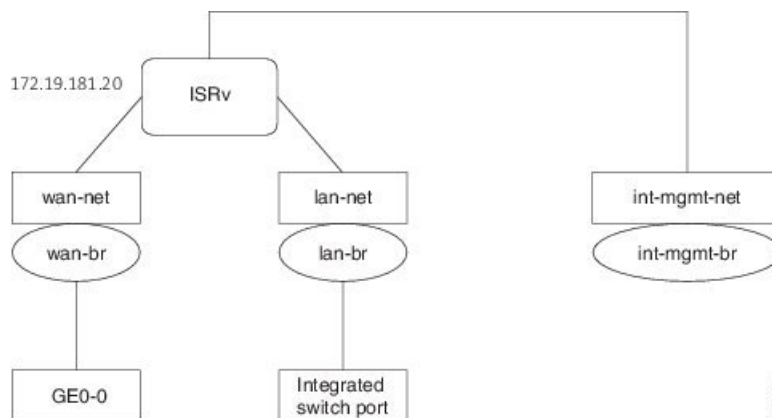

Steps for Deploying a VM

To deploy a Cisco ISRV image:

- Verify that all networks required for your deployment are configured.

```
curl -k -v -u admin:admin -H content-type:application/vnd.yang.data+xml -X
GET https://<NFVIS_IP>/api/config/networks?deep
```

2. Before deploying the VM, you can perform a resource check to ensure that you have sufficient resources for the deployment.

```
curl -k -v -u "admin:admin" -X GET
https://<NFVIS_IP>/api/operational/resources/precheck/vnf/newvnf,isrv-small,true
?deep
```

3. Deploy the Cisco ISRV VM.

```
curl -k -v -u admin:admin -H Accept:application/vnd.yang.data+xml -H
Content-Type:application/vnd.yang.data+xml -X
POST https://<NFVIS_IP>/api/config/vm_lifecycle/tenants/tenant/admin/deployments --data
<deployment>
  <name>ISR</name>
  <vm_group>
    <name>ISR</name>
    <image>isrv-universalk9.16.03.01/image>
    <bootup_time>600</bootup_time>
    <recovery_wait_time>0</recovery_wait_time>
    <recovery_policy>
      <action_on_recovery>REBOOT_ONLY</action_on_recovery>
    </recovery_policy>
    <flavor>isrv-small</flavor>
    <interfaces>
      <interface>
        <nicid>0</nicid>
        <network>int-mgmt-net</network>
        <port_forwarding>
          <port>
            <type>ssh</type>
            <protocol>tcp</protocol>
            <vnf_port>22</vnf_port>
            <external_port_range>
              <start>20022</start>
              <end>20022</end>
            </external_port_range>
          </port>
        </port_forwarding>
      </interface>
      <interface>
        <nicid>1</nicid>
        <network>lan-net</network>
        <ip_address>209.165.201.0</ip_address>
      </interface>
      <interface>
        <nicid>2</nicid>
        <network>wan-net</network>
        <ip_address>209.165.201.1</ip_address>
      </interface>
    </interfaces>
    <scaling>
      <min_active>1</min_active>
      <max_active>1</max_active>
    </scaling>
    <kpi_data>
      <kpi>
        <event_name>VM_ALIVE</event_name>
        <metric_value>1</metric_value>
        <metric_cond>GT</metric_cond>
        <metric_type>UINT32</metric_type>
        <metric_collector>
          <type>ICMPping</type>
        </metric_collector>
      </kpi>
    </kpi_data>
  </vm_group>
</deployment>
```

```

        <nicid>0</nicid>
        <poll_frequency>3</poll_frequency>
        <polling_unit>seconds</polling_unit>
        <continuous_alarm>>false</continuous_alarm>
    </metric_collector>
</kpi>
</kpi_data>
<rules>
  <admin_rules>
    <rule>
      <event_name>VM_ALIVE</event_name>
      <action>ALWAYS log</action>
      <action>TRUE servicebooted.sh</action>
      <action>FALSE recover autohealing</action>
    </rule>
  </admin_rules>
</rules>
<config_data>
  <configuration>
    <dst>bootstrap_config</dst>
    <variable>
      <name>TECH_PACKAGE</name>
      <val>security</val>
    </variable>
    <variable>
      <name>ngio</name>
      <val>enable</val>
    </variable>
  </configuration>
</config_data>
</vm_group>
</deployment>

```



Note If two VM's are connected to the same physical interface, one over SRIOV and another over virtio net from a bridge connected to the packet filter, you cannot ping between the two VM's between these interfaces. Use SRIOV or virtio net on both the VM's to connect to the packet filter over a bridge.

4. Verify the deployment status.

```

curl -k -v -u admin:admin -H Accept:application/vnd.yang.data+xml -H
Content-Type:application/vnd.yang.data+xml -X
GET
https://NFVIS_IP/api/operational/vm_lifecycle/opdata/tenants/tenant/admin/deployments/ISR,-,-?deep

```



Note To enable NIM support on a Cisco ISRv running on Cisco ENCS, you must use the following variable in the ISRv deployment payload.

```

<variable>
  <name>ngio</name>
  <val>enable</val>
</variable>

```

Service Chaining of VMs

Service chaining here refers to a set of network services in the form of VMs using an intermediate network. Cisco Enterprise NFVIS supports service chaining of two or more VMs eliminating the need of dedicated hardware devices for different types of network services.

To service chain traffic between two or more VMs, you will have to create the following:

- Bridge—For example, you can create a new bridge called sc-br.
- Network—For example, you can create a new network called sc-net.
- Launch VM1 and VM2 with an interface from each VM to the service chain network (sc-net).

For more details on how to configure service chaining using APIs, see the following topics:

- [Service Chaining with two VM Images, on page 67](#)
- [Service Chaining of Multiple VMs with Windows or Linux Servers, on page 68](#)

Service Chaining with two VM Images

In this example, a Cisco ISRV VM and a Cisco ASA VM are service chained. For that, you will have to deploy both VMs.

Figure 7: Service Chaining with two VM Images

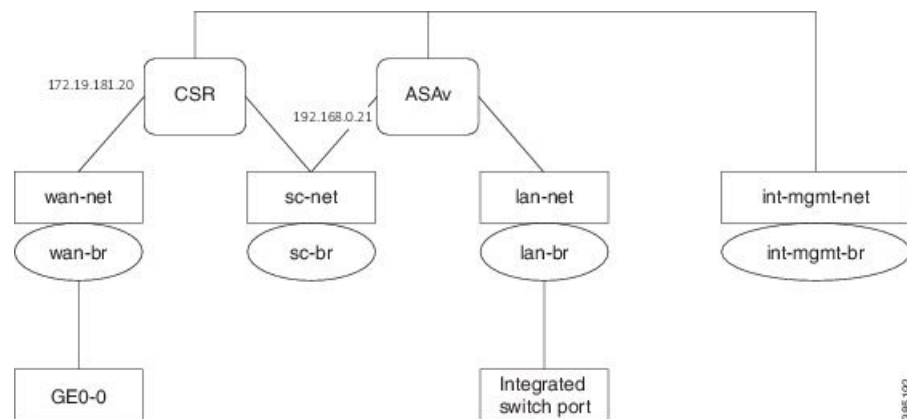

Steps for Service Chaining with Two VM Images

1. Create a new bridge for service chaining.

```
curl -k -v -u admin:admin -H content-type:application/vnd.yang.data+xml -X POST
https://<NFVIS_IP>/api/config/bridges --data
'<bridge><name>sc-br</name></bridge>'
```

2. Create a new network for service chaining, and attach the bridge to the network.

```
curl -k -v -u admin:admin -H content-type:application/vnd.yang.data+xml -X POST
https://<NFVIS_IP>/api/config/networks --data
```

```
'<network><name>sc-net</name><bridge>sc-br</bridge> </network>'
```

3. Verify that all bridges and networks are configured.
4. Deploy the Cisco ISRV VM, and verify the deployment status.
5. Deploy the cisco ASAv VM, and verify the deployment status.

See [Steps for Deploying a VM](#), on page 64 for API command details for Steps 3 to 5.

Service Chaining of Multiple VMs with Windows or Linux Servers

In this example, multiple VMs will be service chained. Cisco ISRV and Cisco ASAv VMs can be deployed as explained in [Service Chaining with two VM Images](#), on page 67.

This section covers Linux server deployment (Windows 2012 server can also be deployed using the same steps.)

Figure 8: Service Chaining of Multiple VMs with Windows or Linux Servers

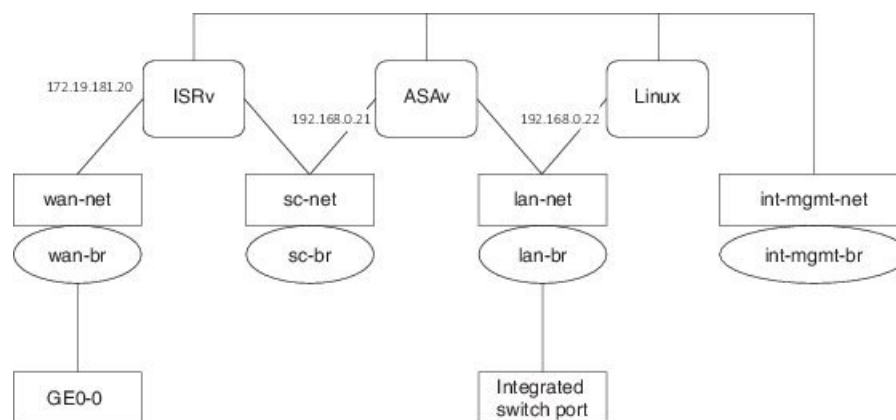

Steps for Service Chaining of Multiple VMs with Windows or Linux Servers

1. Create networks and bridges as required.
See Steps 1 and 2 in [Steps for Service Chaining with Two VM Images](#), on page 67 for details on creating networks and bridges.
2. Deploy Cisco ISRV and Cisco ASAv, and verify their deployment status.
3. Deploy the Linux server VM.
4. Verify the server deployment status.

See the [Steps for Deploying a VM](#), on page 64 for API command details for Steps 2 to 4.



CHAPTER 7

SPAN Session or Port Mirroring

- [About SPAN Sessions, on page 69](#)
- [Configuring SPAN Sessions, on page 69](#)
- [Configuration Examples for SPAN Session Scenarios, on page 71](#)

About SPAN Sessions

The Switched Port Analyzer (SPAN) or Port Mirroring feature helps you analyze network traffic passing through interfaces or VLANs by using SPAN sessions. The SPAN sessions send a copy (mirror) of the traffic to another interface or VLAN on the switch that has been connected to a network analyzer or monitoring device. SPAN does not affect the switching of network traffic on the source interfaces.



Note You must dedicate a destination port for SPAN use. Except for traffic that is required for the SPAN session, destination ports do not receive or forward traffic. When the SPAN is configured on the system, there might be some performance hit.

SPAN Session Interfaces

The interface can be:

- Physical interface
- LAN SRIOV
- VM's vNIC (virtio net)

In the case of virtio net or SRIOV VF, you have to specify the VM group name and NIC ID of the VM interface. If the VM vNIC is virtio net type, then the SPAN session is applied on the OVS bridge. If VM vNIC is SRIOV VF, then the mirror is applied to the hardware bridge. The interface name is specified for a physical interface, for example, GE0-0 or eth0.

Configuring SPAN Sessions

The SPAN session configuration has the following four parameters:

- Session number—Each SPAN session is identified with a unique number.
- Bridge name—The SPAN session is applied to a bridge. For VLAN mirroring, the bridge must be specified. The bridge name is optional if the source or destination interface is configured for the session.
- Source configuration—The source of the mirror traffic can be one of the following:
 - Packets entering (Rx), or exiting (Tx), or both. You can specify multiple interfaces of any type.
 - You can also specify all interfaces on the OVS bridge.
 - All packets entering a VLAN. You can also specify a list of VLANs.
- Destination configuration—The destination for the mirrored traffic can be one of the following:
 - The mirrored traffic can be sent to interfaces of any type.
 - The mirrored traffic can be sent to a specific VLAN. In this case, the original VLAN tag is stripped in the mirrored traffic in favor of the destination VLAN. This loss of original VLAN information might make the mirrored traffic hard to interpret.

To configure a SPAN session:

```
configure terminal
monitor session 2
bridge wan-br
source interface GE0-0
destination vm-vnic Linux2 0
commit
```

Verifying the SPAN Session Configuration

Use the **show system monitor session** command to verify the SPAN session configuration.

```
nfvis# show system monitor session
system monitor session 2
bridge wan-br
destination_vlan ""
destination_interface vnic0
source_vlans ""
source_rx_interfaces "GE0-0"
source_tx_interfaces "GE0-0"
source_all false
statistics "tx_bytes=142660, tx_packets=1380"
```

Use the **show running-config monitor session** command to verify the interface configuration for a SPAN session:

```
nfvis# show running-config monitor session
monitor session 2
destination vm-vnic Linux2 0
source vm-vnic Linux1 0 both
source interface GE0-0 both
```

SPAN Session APIs and Commands

APIs	Commands
<ul style="list-style-type: none"> • /api/config/monitor • /api/operational/monitor\?deep • /api/config/monitor\?deep • /api/operational/system/monitor/session\?deep 	<ul style="list-style-type: none"> • monitor session • bridge • source • destination • show system monitor session • show monitor session status • show running-config monitor session

Configuration Examples for SPAN Session Scenarios

Example: SPAN Session Traffic on a Physical Interface

The following example shows how to configure all traffic coming in or going out on GE0-0 (physical interface) and VM Linux1 (vnic0). And traffic is mirrored to the VM Linux2 (vnic1). With this configuraton, any traffic arriving on vnet1 will be dropped.



Note An existing SPAN session will be in FAIL state after the system reboot. In this case, you need to recreate (delete and create) the SPAN session after the system bootup.

VM deployment interfaces:

- SPAN source: GE0-0 (traffic in both directions)
- SPAN source: Linux1/vnic0, and wan-net (traffic in both directions)
- SPAN destination: Linux2/vnic0, and wan-net

```
nfvis# show running-config monitor session
monitor session 20
  destination vm-vnic Linux2 0
  source vm-vnic Linux1 0 both
  source interface GE0-0 both
!
```

```
nfvis# show system monitor session
system monitor session 20
  bridge wan-br
  destination_vlan ""
  destination_interface vnic11
  source_vlans ""
  source_rx_interfaces "vnic10, GE0-0"
```

```

source_tx_interfaces "vnic10, GE0-0"
source_all           false
statistics           "tx_bytes=142660, tx_packets=1380"
nfvis#

nfvis# show monitor session status
NUMBER  STATUS
-----
20      CREATE_SUCCESS

```

Example: SPAN Session Traffic on a LAN SRIOV

The following example shows how to configure all traffic coming in or going out on an SRIOV interface (VF0). It is also mirrored to VF1.



Note This scenario is applicable only to the Cisco ENCS.

VM deployment for VF-VF scenario:

CentOS_SRIOV, C3, and C5 are CentOS VMs with SRIOV support.

- CentOS_SRIOV: vnic0: wan-net/vnic1: LAN-SRIOV-1 (192.168.1.36)
- C3: vnic0: LAN-SRIOV3 (192.168.1.3)
- C5: vnic0: LAN-SRIOV5 (192.168.1.5)

SPAN destination and source:

- SPAN destination: CentOS_SRIOV (vnic0: wan-net/vnic1: LAN-SRIOV-1)
- SPAN source: C3 (vnic0: LAN-SRIOV-3); traffic in both directions (rx, tx)
- Ping target: C5 (vnic0: LAN-SRIOV-5)

```

nfvis# show running-config monitor session
monitor session 6
 destination vm-vnic CentOS_SRIOV 1
 source vm-vnic C3 0
!
nfvis#

nfvis# show system monitor session
system monitor session 6
 bridge ""
 destination_vlan ""
 destination_interface LAN-SRIOV-1
 source_vlans ""
 source_rx_interfaces LAN-SRIOV-3
 source_tx_interfaces LAN-SRIOV-3
 source_all ""
 statistics ""
nfvis#

nfvis# show monitor session status
NUMBER  STATUS

```

```
-----  
6 CREATE_SUCCESS
```

Example: SPAN Session Traffic on a VLAN

The following example shows how to configure the SPAN session for all traffic entering in VLAN 10 and 11. It is also mirrored to VLAN 20.

```
nfvis# show running-config monitor session  
monitor session 11  
  bridge lan-br  
  destination_vlan 20  
  source_vlan [ 10 11 ]  
!  
  
nfvis# show system monitor session  
system monitor session 11  
  bridge lan-br  
  destination_vlan 20  
  destination_interface ""  
  source_vlans "10, 11"  
  source_rx_interfaces ""  
  source_tx_interfaces ""  
  source_all true  
  statistics "tx_bytes=0, tx_packets=0"  
  
nfvis# show monitor session 11  
NUMBER STATUS  
-----  
11 CREATE_SUCCESS
```



CHAPTER 8

Configuring Packet Capture

The Packet Capture feature helps you capture all packets being transmitted and received over physical and virtual network interface controllers (physical port and vNIC) for analysis. These packets are inspected to diagnose and solve network problems. Packets are stored in the `/data/intdatastore/pktcaptures` folder on the host server.

Benefits

- You can customize the configuration to capture specific packets such as Internet Control Message Protocol (ICMP), TCP, UDP, and Address Resolution Protocol (ARP).
- You can specify a time period over which packets are captured. The default is 60 seconds.

To configure packet capture on a physical port:

```
configure terminal
tcpdump port eth0
```

Output: pcap-location /data/intdatastore/pktcaptures/tcpdump_eth0.pcap

To configure packet capture on a vNIC:

```
configure terminal
tcpdump vnic tenant-name admin deployment-name 1489084431 vm-name ROUTER vnic-id 0 time 30
```

Output: pcap-location /data/intdatastore/pktcaptures/1489084431_ROUTER_vnic0.pcap

Types of Errors

Error	Scenario
Port/vnic not found	When non-existing interface is given as input.
File/directory not created	When the system is running out of disk space.
The <code>tcpdump</code> command fails	When the system is running out of disk space.

These errors are logged in the `nfvis_config.log`. By default, warnings and errors are logged,

Packet Capture APIs and Commands

APIs	Commands
<ul style="list-style-type: none">• /api/operations/packet-capture/tcpdump	<ul style="list-style-type: none">• tcpdump port• tcpdump vnic



CHAPTER 9

VM Image Packaging

VM Image Packaging is a tool for converting qcow2 and img images into a tar.gz format with additional properties and profiles. VM image packaging can be done in two ways:

- **VM Image Packaging Utility:** This is an enhanced packaging process that allows the VM owner to run the **nfvpt.py** utility as a command with a combination of parameters to package the VM.
- **Standard Image Packaging:** This is a manual process in which a raw disk image (qcow2, img) is packaged along with the image properties file and bootstrap files (if needed) into a TAR archive file.
- [VM Image Packaging Utility, on page 77](#)
- [Standard VM Image Packaging, on page 84](#)
- [Appendix, on page 85](#)

VM Image Packaging Utility

A VM image package is a TAR archive file with the root disk image and other descriptor files. This packaging method simplifies the process of a VM image registration and deployment. The attributes specified for the image enable resource requirement specification, creation of VM profiles, and a host of other properties for the VM.

The Cisco Enterprise NFVIS VM image packaging tool, **nfvpt.py**, helps VM owners package their VMs. The tool takes one or more qcow2 images (raw disk file) as the input file along with VM specific properties, bootstrap configuration files (if any), and generates a compressed TAR file.

Contents

The VM image packaging utility contains the following:

- **nfvpt.py**—It is a python based packaging tool that bundles the VM raw disk image/s along with VM specific properties.
- **image_properties_template.xml**—This is the template file for the VM image properties file, and has the parameters with default values. If the user provides new values to these parameters while creating the VM package, the default values get replaced with the user-defined values.
- **nfvis_vm_packaging_utility_examples.txt**—This file contains examples on how to use the image packaging utility to package a VM image.

Usage

To get the list of parameters that can be included in the command, and to get an explanation of each of the parameters, run the **help** command for the tool.

nfvpt.py --help

optional arguments:

```

-h, --help            show this help message and exit
--json JSON           Provide JSON input for bootstrap variables; mutually
                    exclusive with custom and bootstrap configs
--newjson NEWJSON    Provide JSON input for bootstrap variables; mutually
                    exclusive with custom and bootstrap configs
--log_dir LOG_DIR    Log Directory to for logfiles
--multi_use           Add options for use in multiple use-cases
--console_type_serial {true,false}
                    Attach the console serial to the VM; default is false;
                    --console_type_serial=true/false;
--root_file_disk_bus {virtio,ide}
                    root disk file type: --root_file_disk_bus=virtio/ide;
                    default is virtio
--virtual_interface_model {rtl8139}
                    --virtual_interface_model=rtl8139; default is none
--thick_disk_provisioning {true,false}
                    --thick_disk_provisioning=true; default is false
--eager_zero {true,false}
                    --eager_zero=true; default is false
--nocloud {true,false}
                    --nocloud=true/false; default is false
--bootstrap_cloud_init_bus_type {ide,virtio}
                    --bootstrap_cloud_init_bus_type=virtio; default is ide
--bootstrap_cloud_init_drive_type {cdrom,disk}
                    --bootstrap_cloud_init_drive_type=disk; default is
                    cdrom
--bootstrap BOOTSTRAP
                    Every bootstrap file should be a different option Non
                    HA format: --bootstrap
                    <mountpoint>:<file1>,<mountpoint>:<file2>... See
                    usage.txt for more details HA format for SDWAN
                    NetworkHub: --bootstrap mount_point:<value>,file:<file
                    2mount>[,<attrib>:<value>] mount_point:<value> and
                    file:<file2mount> are mandatory followed by one or
                    more attributes in the format <attrib>:<value>
--interface_hot_add {true,false}
                    VM supports interface add without power off. Default
                    is set to true; --interface_hot_add=true/false
--interface_hot_delete {true,false}
                    VM supports interface delete without power off.
                    Default is set to false;
                    --interface_hot_delete=true/false
-v, --verbose         verbose
-q, --quiet           quiet
--no_compress        creates tar file without compressing the input files
--cleanup            deletes all the input and configuration files upon tar
                    file created
--tablet {true,false}
                    : Add input device of type tablet --tablet=true/false;
--ha_package         enable HA packaging
--mgmt_vnic MGMT_VNIC
                    VM management interface identifier
--pack_dir <DIR> PACK
                    package all files in directory

```

Required:

```

-o PACKAGE_FILENAME, --package_filename PACKAGE_FILENAME
    [REQUIRED] file name for the target VNF package name-
    default is root disk image name with extension .tar.gz
-i ROOT_DISK_IMAGE, --root_disk_image ROOT_DISK_IMAGE
    [REQUIRED] List of root disk images to be bundled
    example: --root_disk_image isrv.qcow2;
    --root_disk_image isrv1.qcow2,isrv2.qcow2
--prop_template PROP_TEMPLATE
    image properties template file name including path
    default path is the current dir of the tool and name
    is image_properties_template.xml if the user doesn't
    input this option example: --prop_template
    /usr/bin/image_properties_template.xml
-t VNF_TYPE, --vnf_type VNF_TYPE
    [REQUIRED] VNF type, e.g. ROUTER, FIREWALL, vWAAS,
    vWLC, and OTHER
-n NAME, --vnf_name NAME
    [REQUIRED] Name of the VNF image
-r VNF_VERSION, --vnf_version VNF_VERSION
    [REQUIRED] VNF version, e.g. --vnf_version 1.0 or
    --vnf_version 0.9
--app_vendor APP_VENDOR
    Application Vendor e.g. Cisco, Juniper etc
--monitored {true,false}
    [REQUIRED] Monitored VNF: --monitored=true/false;
--optimize {true,false}
    [REQUIRED] optimized VM: --optimize=true/false;

```

HA options:

```

--ha_capable
--ha_vnic HA_VNIC      VM HA vnic
--ha_vnic_count HA_VNIC_COUNT
    Number of ha_vnics

```

Resources:

```

Resources: min and max - vCPU, memory and disk

--min_vcpu VCPU_MIN   min #vCPU : min number of vCPU supported by VM
    example:--min_vcpu 2
--max_vcpu VCPU_MAX   max #vCPU : max number if vCPU required for VM
    example:--max_vcpu 4
--min_mem MEMORY_MB_MIN
    min mem : min mem in MB required for VM
    example:--min_mem 1024
--max_mem MEMORY_MB_MAX
    max mem : max mem in MB required for VM
    example:--max_mem 4196
--min_disk ROOT_DISK_GB_MIN
    min disk : min disk in GB required for VM
    example:--min_disk 8
--max_disk ROOT_DISK_GB_MAX
    max disk : max disk in GB required for VM
    example:--max_disk 8
--vnic_max VNIC_MAX   max number of Vnics allowed for VM example:--vnic_max
    8
--vnic_names VNIC_NAMES
    list of vnic number to name mapping in format
    number:name example --vnic_names
    1:GigabitEthernet2,2:GigabitEthernet4

```

Profile Options:

```

--profile PROFILE    enter the profile name, profile description, no of
    vCPU required, min memory required in MB, min disk

```

```

        space required in MB, example: --profile
        profile1,"This is profile 1",2,2048,4096 --profile
        profile2,"This is profile 2",4,4096,4096
--default_profile DEFAULT_PROFILE
        default profile

Driver Support Options:
--sriov {true,false} Enable/Disable SRIOV support: --sriov=true/false;
        default is false
--sriov_list SRIOV_DRIVER_LIST
        list of SRIOV drivers example: --sriov_list
        igb,igbvf,i40evf
--pcie {true,false} Not supported
--pcie_list PCIE_DRIVER_LIST
        Not supported

Privilege/Priority Options:
--privileged {true,false}
        Not supported

Custom Properties:
--custom CUSTOM
        custom properties format: --custom ["propattr_<attr>:
        <value>],key:<value>,[keyattr_<attr>:<value>],type:<va
        lue>,val<N>:<value>,[val<N>attr_<attr>:<value>] Allows
        specification of custom properties: 0 or more
        propattr_<attr>:<value> pairs - 'propattr' is a
        keyword and used to specify property attributes
        key:<value> pairs 0 or more keyattr_<attr>:value pairs
        - 'keyattr' is a keyword and is used to specify key
        attributes type:<value> pair - type of value
        valN:<value> pair - val1:value,val2:value etc 0 or
        more valNattr_<attr>:<value> pairs - 'val<N>attr' is
        an attribute for val<N> See usage_examples.txt

```

The table lists the parameters that can be passed to the `nfvpt.py` command.

Parameter	Mandatory/Optional	Description
version	Not applicable	Show program's version number and exit.
help	Not applicable	Show this help message and exit.
package_file_name	Mandatory	File name for the target VNF package. The default is the root disk image name with extension <code>.tar.gz</code> .
disk_img_names	Mandatory	List of root disk images to be bundled. Only the qcow2 images are supported.
img_name	Mandatory	Name of the VNF image.
vnf_type	Mandatory	VNF type Supported types are: ROUTER, FIREWALL, vWAAS, vWLC, and OTHER.
vnf_version	Mandatory	VNF version

Parameter	Mandatory/Optional	Description
monitored	Mandatory	VM health monitoring for those VMs that can be bootstrapped Options are: true/false Monitoring timeout period for a monitored VM is 600 seconds by default
optimize	Mandatory	Optimized VM Options are: true/false
virtual_interface_model	Optional	Default is none.
thick_disk_provisioning	Optional	Default is false.
eager_zero	Optional	Default is false.
bootstrap_cloud_init_bus_type	Optional	Default is IDE.
bootstrap_cloud_init_drive_type	Optional	Mounts the day0 configuration file as disk Default is CD-ROM.
bootstrap	Optional	Bootstrap files for VNF. Two parameters are required in the format of dst:src; dst filename including path has to match exactly to what the VM expects; up to 20 bootstrap files are accepted. For example: --bootstrap ovf-env.xml for ISRv and --bootstrap day0-config for ASAv.
min_vcpu	Optional	Minimum number of vCPUs supported by the VM. The default is 1.
max_vcpu	Optional	Maximum number of vCPUs required for the VM. The default is 8.
min_mem	Optional	Minimum memory in MB required for the VM. The default is 4 GB.
max_mem	Optional	Maximum memory in MB required for the VM. Physical memory: 2 GB The default is 8 GB.

Parameter	Mandatory/Optional	Description
min_disk	Optional	Minimum disk in GB required for the VM. The default is 8 GB.
max_disk	Optional	Maximum disk in GB required for the VM. Available disks are SSD and HDD: 15 GB The default is 16 GB
vnic_max	Optional	Maximum number of VNICs allowed for the VM. The default is 8.
profile	Optional	The profile name, profile description, number of vCPUs required, minimum memory required in MB and minimum disk space required in MB.
default_profile	Optional	The default profile.
sriov	Optional	Enable or disable SRIOV support. The default is false.
sriov_list	Optional	List of SRIOV drivers.
pcie	Optional	Not supported.
pcie_list	Optional	Not supported.
privileged	Optional	Not supported.
custom	Optional	Custom properties to be supported and/or passed to the bootstrap configuration with tokenized variables. This is only used for the local portal to display options for the user to choose while deploying.
pack_dir	Optional	package all files in directory

NFVIS Specific Enhancements



Note Use pack_dir option if the *.tar.gz already exists and you want to modify the bootstrap configuration file or image_properties.xml manually.

The following parameters are added as part of the NFVIS specific enhancements:

```

--pack_dir <DIR> PACK
                                package all files in directory

Resources:

--vnic_names VNIC_NAMES
                                list of vnic number to name mapping in format
                                number:name example --vnic_names
                                1:GigabitEthernet2,2:GigabitEthernet4

```

Usage

Follow the steps to change a single line in day-0 configuration file or add a single option in image_properties.xml:

1. Get the working VM packaging image - isrv*.tar.gz.
2. Extract the contents - tar -xvf isrv*.tar.gz.
3. Modify the file contents as required.
4. nfvpt.py --pack_dir current-working-dir-with-files -i isrv.qcow2 -o isrv.tar.gz

VM Packaging Utility Usage Examples

Given below are the contents of the file *nfvpt_vm_packaging_utility_examples.txt*.

Example 1: Usage for TinyLinux

```

nfvpt.py -o TinyLinux -i TinyLinux.qcow2 -n TinyLinux -t linux -r 1.0 --monitored false
--min_vcpu 1 --max_vcpu 2 --min_mem 1024 --max_mem 1024 --min_disk 1 --max_disk 2
--vnic_max 1 --optimize false

```

Example 2: Usage for ASAv



Note The bootstrap filename has to be *day0-config*. This cannot be modified as ASAv looks for the exact filename.

```

nfvpt.py -o asav961-201 -i asav961-201.qcow2 -n ASAv -t firewall -r 961-201 --monitored
true --bootstrap day0-config:filename1
--min_vcpu 1 --max_vcpu 4 --min_mem 1024 --max_mem 8192 --min_disk 8 --max_disk 16 --vnic_max
8 --optimize true
--profile ASAv5,"ASAv5 profile",1,1024,8192 --profile ASAv10,"ASAv10 profile",1,4096,8192
--profile ASAv30,"ASAv30 profile",4,8192,16384
--default_profile ASAv5

```

Example 3: Usage for ISRv



Note The bootstrap filename has to be *ovf-env.xml*. This cannot be modified as ISRv looks for the exact filename.

```
nfvpt.py -o isrv.16.03.01 -i isrv-universalk9.16.03.01.qcow2 -n ISRv.16.03.01 -t ROUTER -r
  16.03.01 --monitored true --privileged true
--bootstrap ovf-env.xml:file1,ios-xe.txt:file2 --min_vcpu 2 --max_vcpu 8 --min_mem 4096
--max_mem 8192 --min_disk 8 --max_disk 8
--vnic_max 8 --optimize true --profile ISRv-small,"ISRv small profile",2,4096,8192 --profile
  ISRv-medium,"ISRv medium profile",4,4096,8192
--default_profile ISRv-small --sriov_list igb,igbvf,i40evf --custom tech_package,ax
```

Example 4: Usage for a third party VM with config drive (ISO) mounted at specific path on the VM:

```
nfvpt.py -o test.1.0 -i test-1.0.qcow2 -n TEST -t OTHER -r 1.0 --monitored true --privileged
  true
--bootstrap /:bootstrap.xml,/license/lic.txt:license.txt --min_vcpu 2 --max_vcpu 8 --min_mem
  4096 --max_mem 8192
--min_disk 8 --max_disk 8 --vnic_max 8 --optimize true --profile small,"small
  profile",2,4096,8192
--profile medium,"medium profile",4,4096,8192 --default_profile small
```

In this case, *test.1.0.pkg* : *bootstrap.xml* gets mounted as *bootstrap.xml* at the root, and the *license.txt* gets mounted as */license/lic.txt*.

Example 5: Usage for Palo Alto Firewall

```
nfvpt.py -o PA_L3_HA -i PA-VM-KVM-8.0.5.qcow2 --json d.json -t firewall -n "PA FIREWALL"
-r 8.0.5 --app_vendor PA --monitor true --ha_package
```

Example 6: Usage for Asav

```
nfvpt.py -i foo.qcow2 -o asav.tar.gz --json pal.json --app_vendor cisco -t firewall -r 10
--optimize true -n asav --monitored true --ha_package -ha_capable
```

Example 7: Usage for csr

```
nfvpt.py --ha_package --pack_dir /data/intdatastore -i csr1000v-universalk9.16.09.01.qcow2
-o csr1000v-universalk9.16.09.01-ha.tar.gz
```

Standard VM Image Packaging

The standard VM packaging is based on the Open Virtualization Format (OVF) packaging standard, in which a single file is distributed in open virtualization appliance (OVA) format. The VM image is shared using a TAR archive file with the root disk image and descriptor files.



Note Cisco Enterprise NfVIS supports VM packaging in *.tar.gz* (compressed form of OVA) format. Ensure that all supported third party VM images are available in the supported format.

Generating a VM Package

Package files are provided for Cisco ISRV, Cisco ASA, and tiny Linux and Windows server 2000. Vendors are responsible for packaging all third party VMs in the supported format.

1. Create a VM qcow2 image.
2. Create an *image_properties.xml* file with the VM properties. Ensure that you add all mandatory fields. Include the profiles supported for the VM in this file, and select one default profile. If you do not want to monitor the VM bootup, make the bootup time as -1.
3. Create *bootstrap-config* or *day0-config*, if any bootstrap configuration is required for the VM. If the bootstrap configuration requires inputs from the user, use the tokens in the xml or text file. These tokens are populated during the VM deployment with the provided data.



Note

A VM deployment may fail, if there are tokens in the configuration, and the user does not provide the token values in the deployment payload.

4. Create a *package.mf* file, which lists all the files to be bundled into the *.tar.gz* file along with checksums.
5. Generate the packaging file using "tar -cvzf ova_file_name list_of_files_to_be_bundled".
For example, `tar -cvzf isrv.tar.gz isrv-universalk9.03.16.02.S.155-3.S1a-ext-serial.qcow2 image_properties.xml isr_ovf_env.xml package.mf`.

Appendix

VM Image Package Files

The table lists the contents of the VM package that are generated using the packaging tool:

Table 2: VM Image Package Files

File	Description	Mandatory/Optional
Package Manifest (package.mf)	Lists the files in the package and the expected checksum for the files.	Mandatory
VM image properties (vmname_properties.xml)	XML file with resources and features supported by the VM	Mandatory
VM image (vmname.qcow2)	Image file of the VM. Multiple images are supported. One root_disk image file is mandatory.	Mandatory

Bootstrap (bootstrap_file)	Optional	Bootstrap files for VNF. Two parameters are required in the format of dst:src; dst filename including path has to match exactly to what the VM expects; up to 20 bootstrap files are accepted. For example: --bootstrap ovf-env.xml for ISRV and --bootstrap day0-config for ASAv.
----------------------------	----------	--

Package Manifest File

The package manifest XML file provides a list of the files in the package with their names and their expected checksum. SHA1 algorithm (sha1sum) is used to calculate the checksum. This is a mandatory file to be bundled in the VM package. The manifest file must be named as *package.mf*.

Table 3: Package Manifest File Details

Property Name	Description	Property Tag	Mandatory/Optional
File information	XML tree with details of file name, file type, and expected checksum. The root_image and image_properties files are required.	<file_info>	Mandatory
File name	Name of the file	<name>	Mandatory
File type	Describes the file type. Supported types: <ul style="list-style-type: none"> • root_image • image_properties • bootstrap_config_file • ephemeral_disk1_image • ephemeral_disk2_image 	<type>	Mandatory
Expected checksum	The calculated SHA1 checksum to be validated.	<sha1_checksum>	Mandatory

Bootstrap Configuration File

The bootstrap configuration file is an XML or a text file, and contains properties specific to a VM and the environment. Properties can have tokens, which can be populated during deployment time from the deployment payload.

VM Image Properties File

This XML file provides information about the resources supported or required for the VM operation. All mandatory parameters have to be defined. It also supports custom attributes. This is a mandatory file to be bundled in the VM package. The VM package supports up to 10 disks to be bundled into the package.

Table 4: VM Image Properties File Details

Property Name	Description	Property Tag	Possible Values	Mandatory/Optional
VNF Type	VM functionality provided. Router and firewall are predefined types.	<vnf_type>	Router, firewall, Windows, Linux, and custom_type	Mandatory
Name	Name associated with the VM packaging. This name is referenced for VM deployment.	<name>	Any	Mandatory
Version	Version of the package	<version>	Any	Mandatory
Boot-up time	Boot-up time (in seconds) of the VNF before it can be reachable via ping.	<bootup_time>	Any in seconds, (-1) to not monitor boot-up	Mandatory
Root Disk Image Bus	Root image disk bus	<root_file_disk_bus>	virtio, scsi, and ide	Mandatory
Disk-1 bus type	Additional disk 1 image disk bus	<disk_1_file_disk_bus>	virtio, scsi, and ide	Optional
Disk-2 bus type	Disk2 image disk bus	<disk_2_file_disk_bus>	virtio, scsi, and ide	Optional
Disk-10 bus type	Disk10 image disk bus	<disk_10_file_disk_bus>	virtio, scsi, and ide	Optional
Root Disk Image format	Root image disk format	<root_image_disk_format>	qcow2 and raw	Mandatory
Disk-1 Image format	Additional disk 1 image format	<disk_1_image_format>	qcow2 and raw	Optional
Disk-2 Image format	Disk 2 image format	<disk_2_image_format>	qcow2 and raw	Optional
Disk-10 Image format	Disk 10 image format	<disk_10_image_format>	qcow2 and raw	Optional

Serial Console	Serial console supported	<console_type_serial>	true, false	Optional
Minimum vCPU	Minimum vCPUs required for a VM operation	<vcpu_min>		Mandatory
Maximum vCPU	Maximum vCPUs supported by a VM	<vcpu_max>		Mandatory
Minimum memory	Minimum memory in MB required for VM operation	<memory_mb_min>		Mandatory
Maximum memory	Maximum memory in MB supported by a VM	<memory_mb_max>		Mandatory
Minimum root disk size	Minimum disk size in GB required for VM operation	<root_disk_gb_min>		Optional
Maximum root disk size	Maximum disk size in GB supported by a VM	<root_disk_gb_max>		Optional
Maximum vNICs	Maximum number of vNICs supported by a VM	<vnic_max>		Mandatory
SRIOV support	SRIOV supported by VM interfaces. This should have a list of supported NIC device drivers.	<sriov_supported>	true, false	Optional
SRIOV driver list	List of drivers to enable SRIOV support	< sriov_driver_list>		Optional
PCI passthru support	PCI passthru support by VM interfaces	<pcie_supported>	true, false	Optional
PCIE driver list	List of VNICS to enable PCI passthru support	< pcie_driver_list>		Optional

<code><bootstrap_cloud_init_drive_type></code>	Mounts day0 config file as disk (default is CD-ROM)	<code><bootstrap_cloud_init_drive_type></code>	disk, cdrom	Optional
<code><bootstrap_cloud_init_bus_type></code>	Default is IDE	<code><bootstrap_cloud_init_bus_type></code>	virtio, ide	Optional
BOOTSTRAP	Bootstrap files for the VNF. Two parameters are required in the format of dst:src; dst filename including path has to match exactly to what the VM expects; up to 20 bootstrap files are accepted. For example: --bootstrap ovf-env.xml for ISRv and --bootstrap day0-config for ASAv	<code>< bootstrap_file></code>	File name of the bootstrap file	Optional
Custom properties	List of properties can be defined within the custom_property tree. (Example: For ISRv, the technology packages are listed in this block.) If the Cisco Enterprise NFV portal is used to deploy the VM, the portal prompts you for inputs for custom properties fields, and can pass the values to the bootstrap configuration.	<code><custom_property></code>		Optional

Profiles for VM deployment	List of VM deployment profiles. Minimum one profile is required	<profiles>		Optional
Default profile	The default profile is used when no profile is specified during deployment.	<default_profile>		Optional
Monitoring Support	A VM supports monitoring to detect failures.	<monitoring_supported>	true, false	Mandatory
Monitoring Method	A method to monitor a VM. Currently, only ICMP ping is supported.	<monitoring_methods>	ICMPPing	Mandatory if monitoring is true
Low latency	If a VM's low latency (for example, router and firewall) gets dedicated resource (CPU) allocation. Otherwise, shared resources are used.	<low_latency>	true, false	Mandatory
Privileged-VM	Allows special features like promiscuous mode and snooping . By default, it is false.	<privileged_vm>	true, false	Optional
Virtual interface model		<virtual_interface_model>		Optional
Thick disk provisioning	By default, it is false.	<thick_disk_provisioning>	true, false	Optional
Profile for VM deployment	A profile defines the resources required for VM deployment. This profile is referenced during VM deployment.	<profile>		Optional
Name	Profile name	<name>	Any	Mandatory

Description	Description of the profile	<description>	Any	Mandatory
vCPU	vCPU number in a profile	<vcpus>		Mandatory
Memory	Memory - MB in profile	<memory_mb>		Mandatory
Root Disk Size	Disk size - MB in profile .	<root_disk_mb>		Mandatory
VNIC Offload	List of properties that can be set for vnic offload	<vnic_offload>		Optional
Generic Segmentation Offload	Turn generic segmentation offload on or off	<generic_segmentation_offload> (parent: <vnic_offload>)	on, off	Optional
Generic Receive Offload	Turn generic receive offload on or off	<generic_receive_offload> (parent: <vnic_offload>)	on, off	Optional
RX Checksumming	Turn RX checksumming on or off	<rx_checksumming> (parent: <vnic_offload>)	on, off	Optional
TX Checksumming	Turn TX checksumming on or off	<tx_checksumming> (parent: <vnic_offload>)	on, off	Optional
TCP Segmentation Offload	Turn TCP segmentation offload on or off	<tcp_segmentation_offload> (parent: <vnic_offload>)	on, off	Optional



Note A virtual console is supported by default. Specify the root disk size as zero for multiple disks (for example, vWaas deployment) as the system does not support populating multiple disk sizes. Actual disk sizes are calculated from the root_disk files.

Example: Package.mf

```

** shasum - for calculating checksum
<PackageContents>
  <File_Info>
    <name>ISRV_serial_3.16.02.qcow2</name>
    <type>root_image</type>
    <sha1_checksum>93de73ee3531f74fddf99377972357a8a0eac7b</sha1_checksum>
  </File_Info>
  <File_Info>
    <name>image_properties.xml</name>

```

```

    <type>image_properties</type>
    <sha1_checksum>c5bb6a9c5e8455b8698f49a489af3082c1d9e0a9</sha1_checksum>
  </File_Info>
  <File_Info>
    <name>ISRV_ovf_env.xml</name>
    <type> bootstrap_file_1</type>
    <sha1_checksum>c5bb6a9c5e8455b8698f49a489af3082c1d9e0a9</sha1_checksum>
  </File_Info>
  <File_Info>
    <name>ISRV_disk1_image.qcow2</name>
    <type>ephemeral_disk1_image</type>
    <sha1_checksum>aac24513098ec6c2f0be5d595cd585f6a3bd9868</sha1_checksum>
  </File_Info>
</PackageContents>

```

Example: Image Properties

```

<?xml version="1.0" encoding="UTF-8"?>
<image_properties>
  <vnf_type>ROUTER</vnf_type>
  <name>lsrv-universalk9</name>
  <version>03.16.02</version>
  <bootup_time>600</ bootup_time >
  <root_file_disk_bus>virtio</root_file_disk_bus>
  <root_image_disk_format>qcow2</root_image_disk_format>
  <vcpu_min>1</vcpu_min>
  <vcpu_max>8</vcpu_max>
  <memory_mb_min>4096</memory_mb_min>
  <memory_mb_max>8192</memory_mb_max>
  <vnic_max>8</vnic_max>
  <root_disk_gb_min>8</root_disk_gb_min>
  <root_disk_gb_max>8</root_disk_gb_max>
  <console_type_serial>true</console_type_serial>
  <sriov_supported>true</sriov_supported>
  <sriov_driver_list>igb</sriov_driver_list>
  <sriov_driver_list>igbvf</sriov_driver_list>
  <sriov_driver_list>i40evf</sriov_driver_list>
  <pcie_supported>true</pcie_supported>
  <pcie_driver_list> igb </pcie_driver_list>
  <pcie_driver_list> igbvf</pcie_driver_list>
  <pcie_driver_list> i40evf</pcie_driver_list>
  <bootstrap_file_1> ovf-env.xml </bootstrap_file_1>
  <monitoring_supported>true</monitoring_supported>
  <monitoring_methods>ICMPping</monitoring_methods>
  <low_latency>true</low_latency>
  <privileged_vm>true</privileged_vm>
  <cdrom>true</cdrom>
  <custom_property>
    <tech_package>ax</tech_package>
    <tech_package>sec</tech_package>
    <tech_package>ibase</tech_package>
    <tech_package>appx</tech_package>
  </custom_property>
  <profiles>
    <profile>
      <name>ISRV1kv-small</name>
      <description>ISRV upto 50MBPS performance</description>
      <vcpus>1</vcpus>
      <memory_mb>4096</memory_mb>
      <root_disk_mb>8</root_disk_mb>
    </profile>
  </profile>

```

```

        <name>ISRV1kv-medium</name>
        <description>ISRV upto 250MBPS performance</description>
        <vcpus>2</vcpus>
        <memory_mb>4096</memory_mb>
        <root_disk_mb>8</root_disk_mb>
    </profile>
</profiles>
<default_profile>small</default_profile>
</image_properties>

```

Example: Bootstrap Configuration File

```

<?xml version="1.0" encoding="UTF-8"?>
<Environment
xmlns:oe="http://schemas.dmtf.org/ovf/environment/1">
  <PropertySection>
    <Property oe:key="com.cisco.ISRV.config-version.1" oe:value="1.0"/>
    <Property oe:key="com.cisco.isrv.enable-ssh-server.1" oe:value="True"/>
    <Property oe:key="com.cisco.isrv.login-password.1" oe:value="admin"/>
    <Property oe:key="com.cisco.isrv.login-username.1" oe:value="lab"/>
    <Property oe:key="com.cisco.isrv.mgmt-interface.1" oe:value="GigabitEthernet1"/>
    <Property oe:key="com.cisco.isrv.mgmt-ipv4-addr.1" oe:value="{NICID_0_IP_ADDRESS}/24"/>

    <Property oe:key="com.cisco.isrv.mgmt-ipv4-network.1" oe:value=""/>
    <Property oe:key="com.cisco.isrv.license.1" oe:value="{TECH_PACKAGE}"/>
    <Property oe:key="com.cisco.isrv.ios-config-0001" oe:value="vrf definition Mgmt-intf"/>

    <Property oe:key="com.cisco.isrv.ios-config-0002" oe:value="address-family ipv4"/>
    <Property oe:key="com.cisco.isrv.ios-config-0003" oe:value="exit-address-family"/>
    <Property oe:key="com.cisco.isrv.ios-config-0004" oe:value="address-family ipv6"/>
    <Property oe:key="com.cisco.isrv.ios-config-0005" oe:value="exit-address-family"/>
    <Property oe:key="com.cisco.isrv.ios-config-0006" oe:value="exit"/>
    <Property oe:key="com.cisco.isrv.ios-config-0007" oe:value="interface GigabitEthernet1"/>

    <Property oe:key="com.cisco.isrv.ios-config-0008" oe:value="vrf forwarding Mgmt-intf"/>

    <Property oe:key="com.cisco.isrv.ios-config-0009" oe:value="ip address
    {NICID_0_IP_ADDRESS} {NICID_0_NETMASK}"/>
    <Property oe:key="com.cisco.isrv.ios-config-0010" oe:value="no shut"/>
    <Property oe:key="com.cisco.isrv.ios-config-0011" oe:value="exit"/>
    <Property oe:key="com.cisco.isrv.ios-config-0012" oe:value="ip route vrf Mgmt-intf
    0.0.0.0 0.0.0.0 {NICID_0_GATEWAY}"/>
  </PropertySection>
</Environment>

```

Image Properties Template File

The parameters that go into the image properties file are listed in the code extract below.

```

<?xml version="1.0" encoding="UTF-8"?>
<image_properties>
  <vnf_type>ROUTER</vnf_type>
  <name>TEMPLATE</name>
  <version>1.0</version>
  <bootup_time>600</bootup_time>

```

```

<root_file_disk_bus>virtio</root_file_disk_bus>
<root_image_disk_format>qcow2</root_image_disk_format>
<vcpu_min>1</vcpu_min>
<vcpu_max>8</vcpu_max>
<memory_mb_min>4096</memory_mb_min>
<memory_mb_max>8192</memory_mb_max>
<vnic_max>8</vnic_max>
<root_disk_gb_min>8</root_disk_gb_min>
<root_disk_gb_max>16</root_disk_gb_max>
<console_type_serial>>false</console_type_serial>
<sriov_supported>>true</sriov_supported>
<sriov_driver_list>s1</sriov_driver_list>
<sriov_driver_list>s2</sriov_driver_list>
<sriov_driver_list>s3</sriov_driver_list>
<pcie_supported>>false</pcie_supported>
<monitoring_supported>>true</monitoring_supported>
<monitoring_methods>ICMPping</monitoring_methods>
<low_latency>>true</low_latency>
<privileged_vm>>false</privileged_vm>
<cdrom>>true</cdrom>
<bootstrap_file_1>b1.xml</bootstrap_file_1>
<bootstrap_file_2>b2.txt</bootstrap_file_2>
<custom_property>
  <key>val</key>
</custom_property>
<profiles>
  <profile>
    <name>small</name>
    <description>small</description>
    <vcpus>1</vcpus>
    <memory_mb>1024</memory_mb>
    <root_disk_mb>4096</root_disk_mb>
  </profile>
  <profile>
    <name>medium</name>
    <description>medium</description>
    <vcpus>2</vcpus>
    <memory_mb>4096</memory_mb>
    <root_disk_mb>8192</root_disk_mb>
  </profile>
</profiles>
<default_profile>small</default_profile>
</image_properties>

```



CHAPTER 10

Upgrading Cisco Enterprise NFVIS

The Cisco Enterprise NFVIS upgrade image is available as a `.nfvispkg` file. Currently, downgrade is not supported. All RPM packages in the Cisco Enterprise NFVIS upgrade image are signed to ensure cryptographic integrity and authenticity. In addition, all RPM packages are verified during Cisco Enterprise NFVIS upgrade. For more information about the Image Signing and Verification feature, see [Image Signing and Verification, on page 6](#).

Ensure that you copy the image to the Cisco Enterprise NFVIS server before starting the upgrade process. Always specify the exact path of the image when registering the image. Use the `scp` command to copy the upgrade image from a remote server to your Cisco Enterprise NFVIS server. When using the `scp` command, you must copy the image to the `/data/intdatastore/uploads` folder on the Cisco Enterprise NFVIS server. The following is an example on how to use the `scp` command to copy the upgrade image:

```
scp -P 22222 nfvis-351.nfvispkg admin@192.0.2.9:  
/data/intdatastore/uploads/nfvis-351.nfvispkg
```

Alternatively, you can upload the image to the Cisco Enterprise NFVIS server using the **System Upgrade** option from the Cisco Enterprise NFVIS portal.



Note When the NFVIS upgrade is in progress, ensure that the system is not powered off. If the system is powered off during the NFVIS upgrade process, the system can become inoperable and you need to reinstall the system.

The upgrade process comprises two tasks:

- Registering the image using the `system upgrade image-name` command.
- Upgrading the image using the `system upgrade apply-image` command.

Registering an Image

To register an image:

```
configure terminal  
system upgrade image-name nfvis-351.nfvispkg location /data/intdatastore/uploads  
commit
```



Note You must verify the image registration status before upgrading the image using the **system upgrade apply-image** command. The package status must be valid for the registered image.

Verifying the Image Registration

Use the **show system upgrade reg-info** command in the privileged EXEC mode to verify the image registration.

```
nfvis# show system upgrade reg-info
PACKAGE
NAME                LOCATION                VERSION                STATUS  UPLOAD DATE
-----
nfvis-351.nfvispkg  /data/upgrade/register/nfvis-351.nfvispkg  3.6.1-722  Valid
2017-04-25T10:29:58.052347-00:00
```

Upgrading the Registered Image

To upgrade the registered image:

```
configure terminal
system upgrade apply-image nfvis-351.nfvispkg scheduled-time 5
commit
```

Verifying the Upgrade Status

Use the **show system upgrade apply-image** command in the privileged EXEC mode

```
nfvis# show system upgrade apply-image
UPGRADE
NAME  STATUS  FROM  UPGRADE TO
-----
nfvis-351.nfvispkg  SUCCESS  3.5.0  3.5.1
```

The only upgrade supported when BIOS secured boot (UEFI mode) is enabled on ENCS 5400 platform is:
NFVIS 3.8.1 + BIOS 2.5(legacy) --> NFVIS 3.9.1 + BIOS 2.6(legacy)

The following upgrade requires re-installation:

NFVIS 3.8.1 + BIOS 2.5(legacy) --> NFVIS 3.9.1 + BIOS 2.6(UEFI)

NFVIS 3.9.1 + BIOS 2.6(legacy) --> NFVIS 3.9.1 + BIOS 2.6(UEFI)

Upgrade APIs and Commands

Upgrade APIs	Upgrade Commands
<ul style="list-style-type: none">• /api/config/system/upgrade• /api/config/system/upgrade/image-name• /api/config/system/upgrade/reg-info• /api/config/system/upgrade/apply-image	<ul style="list-style-type: none">• system upgrade image-name• system upgrade apply-image• show system upgrade reg-info• show system upgrade apply-image



CHAPTER 11

Configuring vBranch High Availability

The vbranch high availability (HA) solution is a box-to-box HA. It is similar to the traditional branch, which uses physical boxes for routing and other services. This solution uses the Hot Standby Router Protocol (HSRP), a default gateway redundancy (or a first hop redundancy), which allows the network to recover from the failure of the device acting as the default gateway for the LAN side end points (devices). The routing protocols are configured to converge the traffic on the WAN side, when there are failures. So, this solution uses HSRP to provide redundancy for the branch connectivity on the LAN side. The Enhanced Interior Gateway Routing Protocol (EIGRP), Open Shortest Path First (OSPF) routing protocols, and Embedded Event manager (EEM) scripts are configured to converge on the WAN side. The following section explains the redundancy solutions for the branch, with each ENCS having separate active WAN link.



Note You can use this recommended HA design as is, or modify as per the field requirement.

- [Prerequisites for vBranch HA, on page 99](#)
- [vBranch HA Design and Topology, on page 100](#)
- [Enable Virtual NIC Failure Detection with Track Feature , on page 101](#)
- [Isolating LAN and Transit Link Traffic for vBranch HA, on page 103](#)
- [Packet Flow for vBranch HA, on page 104](#)
- [Configuration Examples for vBranch HA, on page 105](#)
- [Cisco ENCS Failure Points, on page 108](#)

Prerequisites for vBranch HA

- Cisco ISRv must run HSRP on the LAN facing interface.
- The WAN links are active on both Cisco ENCS1 and Cisco ENCS2. Each of the ENCS WAN link is connected to the WAN network (most cases with two SPs), with two ENCSs in an active-active mode.
- The LAN facing links of both Cisco ENCS devices are connected to an external switch (as an uplink), and all the devices on the LAN segment are also connected to the external switch. There should be no LAN device connecting directly to the Cisco ENCS internal switch.
- A transit link, which is L3 routed, is configured between the Cisco ENCS devices. Since the LAN HSRP makes only one device active, the transit link is used to forward traffic This link is used to forward traffic from the standby ENCS WAN to LAN or LAN to WAN. This link can be back-to-back connected on the ENCS internal switch ports.

should also have same features configured on both Cisco ENCS devices. The traffic goes through the service VNFs on the active Cisco ENCS only, even though both Cisco ENCS devices are actively forwarding on the WAN link. On a failover, the traffic will go over the service VNFs on the newly active ENCS (ENCS2).

This HA solution requires a transit link configured between two Cisco ENCS devices. One of the LAN ports from each of the Cisco ENCS can be connected back to back. This transit link port should be extended to the Cisco ISRV.

Enable Virtual NIC Failure Detection with Track Feature

You can enable the Track feature to detect virtual NIC failure in the following two scenarios:

- When the underlying physical link fails, the HSRP or routing protocols cannot detect the failure—This is because the line protocol does not go down when the underlying physical link fails if the Cisco ISRV is using a virtual NIC.
- With EEM scripts unconfigured, when the underlying physical link fails, the virtual NIC line protocol does not go down. In this case the routing protocol does not withdraw the routes.

Configuration Example for the Track Feature with Scenario 1 (HSRP)

In the virtual environment, you can enable higher protocols like HSRP to take action when the link failure happens. One way to achieve this is by configuring the Track feature on some object (ICMP ping) in Cisco IOS XE.

In Cisco ISRV, if the LAN interface where HSRP is running is a virtual NIC, then you can configure the track object to ping some device on the LAN segment, and monitor the connection failures. So, when the track object is down due to some connection failure, you can configure an action as to shut down the HSRP group, so that the peer will take over the active role making the default Gateway IP active. Without this track object, both Cisco ENCS devices will become active getting into a split-brain scenario.

The following example shows how to configure the track object on the active ISRV1, and monitor the connection failures by pinging the device IP in the network.



Note The Cisco ISRV should have AX license to configure the IP SLA.

```
track 1 ip sla 1 reachability
ip sla 1
  icmp-echo 192.0.2.1 source-ip 198.51.100.1
  frequency 5
ip sla schedule 1 life forever start-time now
!
track 5 ip sla 5 reachability
ip sla 5
  icmp-echo 192.0.2.2 source-ip 198.51.100.2
  frequency 5
ip sla schedule 5 life forever start-time now
!
```

The following output shows that the Track 1 reachability is failed, and Track 5 is up.

```
device1# show track
```

```

Track 1
  IP SLA 1 reachability
  Reachability is Down
    11 changes, last change 00:01:22
  Latest operation return code: Timeout
  Tracked by:
    HSRP GigabitEthernet3 25
Track 5
  IP SLA 5 reachability
  Reachability is Up
    4 changes, last change 00:02:32
  Latest operation return code: OK
  Latest RTT (milliseconds) 1
  Tracked by:
    HSRP GigabitEthernet3 25
ISRV1#

```

The following example shows how to configure the Track object to monitor the line protocol state of the interface:

```
track 2 interface GigabitEthernet2 line-protocol
```

The following output shows that the line protocol state is down:

```

device# show track
Track 2
  Interface GigabitEthernet2 line-protocol
  Line protocol is Down ((hw down))
    8 changes, last change 00:01:25
  Tracked by:
    HSRP GigabitEthernet3 25

```

Configuration Example for the Track Feature with Scenario 2 (EEM Scripts)

With EEM scripts unconfigured, when an underlying link fails, the virtual NIC line protocol does not go down. This causes the problem as the routing protocol will not withdraw the routes. You can configure a Track object (can use the same object defined for HSRP above) to detect the failure. When the failure happens, the active Cisco ISRV has to withdraw the routes or network, so that the WAN link does not receive any traffic. One way to withdraw the routes is configure the EEM script, and delete the network from EIGRP.

The following example shows how to configure the EEM scripts, and remove the network from EIGRP:

```

track 5 ip sla 5 reachability
!
ip sla 5
  icmp-echo 192.0.2.1 source-ip 192.0.2.18
  frequency 5
ip sla schedule 5 life forever start-time now
!
event manager applet noshut_int
  event track 5 state up
  action 1.1 cli command "enable"
  action 1.2 cli command "config t"
  action 1.3 cli command "router eigrp 10"
  action 1.4 cli command "network 192.0.2.1 0.0.0.255"
  action 1.5 cli command "end"
event manager applet shut_int
  event track 5 state down
  action 1.1 cli command "enable"
  action 1.2 cli command "config t"
  action 1.3 cli command "router eigrp 10"

```



```
action 1.4 cli command "no network 192.0.2.1 0.0.0.255"
action 1.5 cli command "end"
```

In the virtual environment HSRP, make sure to use standby use-bia.

The following configuration example shows how to use the Track object (Track 5) to shut down HSRP group in ISRv1, when reachability is down for Track 5:

```
interface GigabitEthernet4
description Service-NET-Virtio
ip address 192.0.2.1 255.255.255.0
standby use-bia
standby 25 ip 192.0.2.22
standby 25 timers 1 5
standby 25 priority 105
standby 25 preempt
standby 25 track 5 shutdown
```

Isolating LAN and Transit Link Traffic for vBranch HA

LAN traffic and transit link traffic shall be isolated by configuring different VLANs for each traffic since both links are connected to the same ENCS internal switch. If you do not isolate these traffic, both LAN traffic and transit link will flow through the same internal switch on the Cisco ENCS.

The following Cisco ENCS switch configuration example shows how to isolate traffic. In this example, the Cisco ISRv is configured to send HSRP traffic as an untag and transit traffic in VLAN 46. So, to isolate HSRP traffic and transit traffic on the internal switch, the Gigabit Ethernet interface 1/0 is connected to a LAN network and Gigabit Ethernet interface 1/1 is configured as the transit link. The Gigabit Ethernet interface 1/1 allows the VLAN 46 to pass the transit traffic. It should also have non-default (other than 1) native VLAN (for example, VLAN 2), because the Cisco ENCS internal switch uplink (internal) has the native VLAN 1 configured.

Enable MSTP on all switches before isolating traffic.

```
switch
interface gigabitEthernet1/0
negotiation auto
no shutdown
switchport access vlan 1
switchport mode access
switchport trunk native vlan 1
switchport trunk allowed vlan 1-2349,2450-4093
!
!
!
switch
interface gigabitEthernet1/1
negotiation auto
no shutdown
spanning-tree mst 1 cost 200000000
spanning-tree mst 2 cost 200000000
switchport access vlan 46
switchport mode trunk
switchport trunk native vlan 2
switchport trunk allowed vlan 1-2349,2450-4093
!
!
```

```

!
spanning-tree enable
spanning-tree mode mst
spanning-tree mst configuration
name      region1
revision 1
instance 1 vlan 1
instance 2 vlan 46
!

```

Use the **show switch vlan detailed** command to verify the configuration as shown below:

```
device# show switch vlan detailed
```

```

platform-detail hardware_info Manufacturer "Cisco Systems, Inc."
platform-detail hardware_info PID ENCS5412/K9
platform-detail hardware_info SN FGL212681GK
platform-detail hardware_info hardware-version M3
platform-detail hardware_info UUID 7BBEBDE0-CE3C-42E5-B564-CFEE8F18AE97
platform-detail hardware_info Version 3.8.1-FC3
platform-detail hardware_info Compile_Time "Sunday, April 15, 2018 [20:38:10 PDT]"
platform-detail hardware_info CPU_Information "Intel(R) Xeon(R) CPU D-1557 @ 1.50GHz 12
cores"
platform-detail hardware_info Memory_Information "16227148 kB"
platform-detail hardware_info Disk_Size "64.0 GB"
platform-detail hardware_info CIMC_IP NA
platform-detail hardware_info Entity-Name ENCS
platform-detail hardware_info Entity-Desc "Enterprise Network Compute System"
platform-detail software_packages Kernel_Version 3.10.0-514.21.1.1.el7.x86_64
platform-detail software_packages QEMU_Version 1.5.3
platform-detail software_packages LibVirt_Version 3.2.0
platform-detail software_packages OVS_Version 2.5.2
platform-detail switch_detail UUID NA
platform-detail switch_detail Type NA
platform-detail switch_detail Name NA
platform-detail switch_detail Ports 8

```

NAME	TYPE	MEDIA	LINK	SPEED	MTU	MAC	PCI DETAIL
GE0-0	physical	Twisted Pair	up	1000	9216	70:db:98:c3:f3:64	02:00:0
GE0-1	physical	Twisted Pair	up	1000	9216	70:db:98:c3:f3:65	02:00:1
MGMT	physical	Twisted Pair	up	1000	1500	70:db:98:c3:f3:d8	0e:00:0

Packet Flow for vBranch HA

This section explains high-level packet flow in failure and non-failure cases.

Non-Failure Case

In the non-failure case, both active and standby Cisco ENCS devices are up and running.

- LAN to WAN through the standby ENCS1 WAN link
 - The device in the LAN segment is configured with the default gateway as the HSRP virtual IP address, and since ENCS1 is an active HSRP, LAN traffic first comes to the active ENCS1.
 - LAN traffic goes through the service chain VM (Cisco ASA_v), and then hits the Cisco ISR_v. In this case, the destination IP is routable through the ENCS1 WAN interface. The Cisco ISR_v sends traffic over the WAN link.

- LAN to WAN through the standby ENCS2 WAN link—In this case, the LAN to WAN traffic uses the transit link between the active and standby devices.
 - Devices in the LAN segment are configured with the default gateway as the HSRP virtual IP address, and since ENCS1 is an active HSRP, the LAN traffic first comes to the active ENCS1.
 - The LAN traffic goes through the service chain VMs (Cisco ASAv), and then hits the active Cisco ISRV. In this case, the destination IP is routable through the ENCS2 WAN interface. The traffic is sent to the Cisco ISRV on ENCS2 over the transit link, and then sent out over the WAN link to the destination.
- WAN to LAN through the active ENCS1
 - The WAN traffic hits the Cisco ISRV on ENCS1, then it goes through the service chain VMs, and sent to the LAN device.
- WAN to LAN through the standby ENCS2 WAN link—In this case, the WAN to LAN traffic uses the transit link between the active and standby devices.
 - The WAN traffic comes to the Cisco ISRV on ENCS2. The PBR/PFR configuration forces the traffic to use the transit link instead of the directly connected LAN port. So, the traffic is sent to the Cisco ISRV on ENCS1 over the transit link.
 - Then, the traffic on ENCS1 goes through the service chain VMs, and sent to the LAN device.

Failure Case

In the failure case, the active device goes down, and the standby device becomes active.

The virtual IP (default gateway) address becomes active on ENCS2. The transit link will not be used. The traffic now goes through the service chain VMs on ENCS2, and gets forwarded directly between WAN and LAN interfaces. The PBR/PFR configuration should monitor the HSRP state, and use the LAN port instead of the transit link to forward LAN traffic.

Configuration Examples for vBranch HA

This sample configuration is for Cisco ENCS HA with a dual-WAN scenario. The Cisco ISRV is configured with vNICs connected to the wan-net, service-net, and transit link. HSRP is configured on the service-net interface. Each Cisco ENCS is provisioned with the Cisco ASAv (service-net) and Cisco vWAAS (service-net).



Note You can use this design as is, or modify as per the field requirement.

Example: Active Cisco ENCS Configuration with ISRV1

```
interface GigabitEthernet1
 vrf forwarding Mgmt-intf
 ip address 192.0.2.1 255.255.255.0
 negotiation auto
!
```

```

interface GigabitEthernet2
  description WAN-GEO-0-SRIOV-1
  ip address 192.0.2.2 255.255.255.0
  negotiation auto
!
interface GigabitEthernet3
  description LAN-NET
  no ip address
  shutdown
  negotiation auto
!
interface GigabitEthernet4
  description Service-NET-Virtio
  ip address 192.0.2.3 255.255.255.0
  standby use-bia
  standby 25 ip 192.0.2.20
  standby 25 timers 1 5
  standby 25 priority 105
  standby 25 preempt
  standby 25 track 1 decrement 10
  standby 25 track 2 decrement 10
  standby 25 track 3 decrement 10
  standby 25 track 5 shutdown
  standby 25 track 6 shutdown
  standby 25 track 7 shutdown
  negotiation auto
  bfd interval 9000 min_rx 9000 multiplier 3
!
interface GigabitEthernet5
  ip address 192.0.2.4 255.255.255.0
!
!
router eigrp stub 10
  network 25.25.25.0 0.0.0.255
  network 38.38.38.0 0.0.0.255
  network 46.46.46.0 0.0.0.255
  !
!
track 1 ip sla 1 reachability
!
track 2 interface GigabitEthernet2 line-protocol
!
track 3 interface GigabitEthernet4 line-protocol
!
track 5 ip sla 5 reachability
!
track 6 ip sla 6 reachability
!
track 7 ip sla 7 reachability
!
ip sla 1
  icmp-echo 9.9.9.29 source-ip 192.0.2.2
  frequency 5
ip sla schedule 1 life forever start-time now
!
ip sla 5
  icmp-echo 25.25.25.11 source-ip 192.0.2.3
  frequency 5
ip sla schedule 5 life forever start-time now
!
ip sla 6
  icmp-echo 25.25.25.51 source-ip 192.0.2.3
  frequency 5
ip sla schedule 6 life forever start-time now

```

```

!
ip sla 7
 icmp-echo 25.25.25.75 source-ip 192.0.2.3
 frequency 5
ip sla schedule 7 life forever start-time now
!
event manager applet noshut_int
 event track 5 state up
  action 1.1 cli command "enable"
  action 1.2 cli command "config t"
  action 1.3 cli command "router eigrp 10"
  action 1.4 cli command "network 25.25.25.0 0.0.0.255"
  action 1.5 cli command "end"
event manager applet shut_int
 event track 5 state down
  action 1.1 cli command "enable"
  action 1.2 cli command "config t"
  action 1.3 cli command "router eigrp 10"
  action 1.4 cli command "no network 25.25.25.0 0.0.0.255"
  action 1.5 cli command "end"
event manager applet ASAv_noshut_int
 event track 6 state up
  action 1.1 cli command "enable"
  action 1.2 cli command "config t"
  action 1.3 cli command "router eigrp 10"
  action 1.4 cli command "network 25.25.25.0 0.0.0.255"
  action 1.5 cli command "end"
event manager applet ASAv_shut_int
 event track 6 state down
  action 1.1 cli command "enable"
  action 1.2 cli command "config t"
  action 1.3 cli command "router eigrp 10"
  action 1.4 cli command "no network 25.25.25.0 0.0.0.255"
  action 1.5 cli command "end"
event manager applet vWAAS_noshut_int
 event track 7 state up
  action 1.1 cli command "enable"
  action 1.2 cli command "config t"
  action 1.3 cli command "router eigrp 10"
  action 1.4 cli command "network 25.25.25.0 0.0.0.255"
  action 1.5 cli command "end"
event manager applet vWAAS_shut_int
 event track 7 state down
  action 1.1 cli command "enable"
  action 1.2 cli command "config t"
  action 1.3 cli command "router eigrp 10"
  action 1.4 cli command "no network 25.25.25.0 0.0.0.255"
  action 1.5 cli command "end"
!
end

```

Example: Standby Cisco ENCS Configuration with ISRV2

```

interface GigabitEthernet1
 vrf forwarding Mgmt-intf
 ip address 192.0.2.1 255.255.255.0
 negotiation auto
!
interface GigabitEthernet2
 description WAN-GE0-0-SRIOV-1
 ip address 192.0.2.21 255.255.255.0

```

```

negotiation auto
!
interface GigabitEthernet3
no ip address
shutdown
negotiation auto
!
interface GigabitEthernet4
description Service-NET-virtio
ip address 192.0.2.22 255.255.255.0
standby use-bia
standby 25 ip 192.0.2.20
standby 25 timers 1 5
standby 25 preempt
negotiation auto
bfd interval 9000 min_rx 9000 multiplier 3
!
interface GigabitEthernet5
ip address 192.0.2.23 255.255.255.0
!
!
router eigrp 10
network 8.8.8.0 0.0.0.255
network 25.25.25.0 0.0.0.255
network 46.46.46.0 0.0.0.255
!

```

Cisco ENCS Failure Points

Failure Points	Sequence of Events
ENCS chassis hardware failure: <ul style="list-style-type: none"> • Power down • Power cycle • Reboot Cisco Enterprise NFVIS software failure <ul style="list-style-type: none"> • Crash Cisco ISRv software failure <ul style="list-style-type: none"> • Stop (shutdown) • Reboot • Crash • Error 	<ol style="list-style-type: none"> 1. HSRP on ENCS2 detects the reachability failure to ENCS1, and triggers the failover. LAN virtual IP becomes active on ENCS2. 2. WAN-IP1 on ENCS1 becomes unreachable, and all the routes converge towards WAN-IP2 on ENCS2. WAN-IP2 is the only IP for branch connectivity. 3. All the WAN to LAN, and LAN to WAN traffic will now flow through ENCS2. 4. The PBR/PFR configuration will now select the LAN port as the preferred path instead of the transit link for the traffic heading to LAN.

ISRv1 (Active) Before the Failure

```
ISRv1# show platform software vnic-if interface-mapping
```

```

Interface Name      Driver Name      Mac Addr
-----
GigabitEthernet5   i40evf          5254.003a.1020 (LAN-SRIOV-2)
GigabitEthernet4   virtio          5254.0053.e392 (service-net)
GigabitEthernet3   i40evf          5254.00c4.b925 (LAN-SRIOV-1)
GigabitEthernet2   igbvf          5254.00d2.cc9a (GEO-0-SRIOV-1)
GigabitEthernet1   virtio          5254.00d2.1b1c (int-mgmt-net)
    
```

ISRV1# **show standby brief**

```

          P indicates configured to preempt.
          |
Interface  Grp  Pri P State  Active      Standby      Virtual IP
Gi4        25  105 P Active local      192.0.2.1    192.0.2.222
#
    
```

ISRV2 (Standby) Before the Failure

ISRV2#**show platform software vnic-if interface-mapping**

```

Interface Name      Driver Name      Mac Addr
-----
GigabitEthernet5   i40evf          5254.00cc.ce9f (LAN-SRIOV-2)
GigabitEthernet4   virtio          5254.00e7.523f (Service-net)
GigabitEthernet3   i40evf          5254.0055.ee45 (LAN-SRIOV-1)
GigabitEthernet2   igbvf          5254.00a3.d443 (GEO-0-SRIOV-1)
GigabitEthernet1   virtio          5254.0048.e84c (int-mgmt-net)
    
```

ISRV2#**show standby brief**

```

          P indicates configured to preempt.
          |
Interface  Grp  Pri P State  Active      Standby      Virtual IP
Gi4        25  100 P Standby 192.0.2.20  local      192.0.2.222
    
```

ISRV2 After the Failure

ISRV1 becomes unreachable. ISRV2: The HSRP failover occurs, and the state changes from Standby to Active. The virtual IP (LAN side default gateway) becomes active on ENCS2 ISRV2.

ISRV2# **show standby brief**

```

          P indicates configured to preempt.
          |
Interface  Grp  Pri P State  Active      Standby      Virtual IP
Gi4        25  100 P Active local      unknown      192.0.2.222
    
```

ISRV2# **show logging**

```

*Dec 13 21:22:17.138: %HSRP-5-STATECHANGE: GigabitEthernet4 Grp 25 state Speak -> Standby
*Dec 13 21:22:32.385: %HSRP-5-STATECHANGE: GigabitEthernet4 Grp 25 state Standby -> Active
    
```

Failure Points	Sequence of Events
WAN Net1 failure (WAN SRIOV VF connected to ISRV1) <ul style="list-style-type: none"> • Link down WAN Phy link failure	<ol style="list-style-type: none"> 1. ISRV1 HSRP on ENCS1 detects the WAN connection failure. It reduces the LAN-HSRP priority. This failure is detected when the interface goes down due to VF going down or track object going down.

Failure Points	Sequence of Events
<ul style="list-style-type: none"> • Switch failure • End-to-end connectivity failure 	<ol style="list-style-type: none"> 2. WAN-IP1 becomes unreachable, and all the routes converge towards WAN-IP2 on ENCS2. WAN-IP2 is the only IP for branch connectivity. 3. HSRP on ENCS2 becomes higher priority in the group, and takes over the active role. LAN-virtual IP becomes active on ENCS2. 4. The PBR/PFR configuration will now select the LAN port as the preferred path instead of the transit link for the traffic destined to LAN. 5. All the WAN to LAN, and LAN to WAN traffic will now flow through ENCS2.

ISRV1 After the Failure

ISRV1 becomes standby.

```
ISRV1# show ip interface brief
```

```
Interface      IP-Address      OK? Method Status      Protocol
GigabitEthernet1 192.0.2.1      YES NVRAM  up          up
GigabitEthernet2 192.0.2.2      YES NVRAM  down        down
GigabitEthernet3 unassigned      YES NVRAM  administratively down down
GigabitEthernet4 192.0.2.3      YES NVRAM  up          up
GigabitEthernet5 unassigned      YES NVRAM  up          up
```

```
ISRV1# show standby brief
```

```
          P indicates configured to preempt.
          |
Interface  Grp  Pri  P State   Active      Standby      Virtual IP
Gi4        25   85   P Standby  192.0.2.22  local        192.0.2.222
```

```
ISRV1#
```

```
ISRV1#show logg
```

```
*Dec 14 03:41:52.307: %TRACK-6-STATE: 2 interface Gi2 line-protocol Up -> Down
*Dec 14 03:42:37.744: %HSRP-5-STATECHANGE: GigabitEthernet4 Grp 25 state Active -> Speak
*Dec 14 03:42:43.663: %HSRP-5-STATECHANGE: GigabitEthernet4 Grp 25 state Speak -> Standby
```

```
ISRV1#
```

```
ISRV1#show track
```

```
Track 1
  IP SLA 1 reachability
  Reachability is Down
  1405 changes, last change 00:03:08
  Latest operation return code: Timeout
  Tracked by:
    HSRP GigabitEthernet4 25
```

ISRV2 After the Failure

```
ISRV2# show standby brief
```

```
          P indicates configured to preempt.
          |
Interface  Grp  Pri  P State   Active      Standby      Virtual IP
Gi4        25   100 P Active  local        192.0.2.3    192.0.2.222
```

Failure Points	Sequence of Events
<p>LAN Phy link failure</p> <ul style="list-style-type: none"> • Switch failure • End-to-end connectivity failure <p>LAN connectivity failure</p> <ul style="list-style-type: none"> • Switch failure • End-to-end connectivity failure <p>SC Net failure (ISRV service-net down)</p> <ul style="list-style-type: none"> • Link down <p>VNFs (Cisco ASAv, Cisco vWAAS, and Windows/Linux)</p> <ul style="list-style-type: none"> • Power down • Power cycle • Crash/reboot 	<ol style="list-style-type: none"> 1. ISRV1 HSRP on ENCS1 detects the LAN connection failure, and shut down the HSRP group. This failure is detected when the interface goes down due to the track object going down. 2. EEM script on ISRV1 withdraws the routes (for example, delete EIGRP networks). All the branch traffic routes will now converge towards WAN-IP2 on ENCS2. WAN-IP2 is the only IP for branch connectivity. 3. HSRP on ENCS-2 becomes active in the group. LAN virtual IP becomes active on ENCS2. 4. On ISRV2, the PBR/PFR configuration will now select the LAN port as the preferred path, instead of the transit link for the traffic destined to LAN. 5. All the WAN to LAN and LAN to WAN traffic will now flow through ENCS2.

ISRV1 After the Failure

```

ISRV1# show track
Track 7
  IP SLA 7 reachability
  Reachability is Down
    7 changes, last change 00:01:40
  Latest operation return code: Timeout
  Tracked by:
    HSRP GigabitEthernet3 25
    EEM 2450904616
    EEM 2450905656
ISRV1#

ISRV1# show ip eigrp topo
EIGRP-IPv4 Topology Table for AS(10)/ID(53.53.53.51)
Codes: P - Passive, A - Active, U - Update, Q - Query, R - Reply,
       r - reply Status, s - sia Status

P 19.19.19.0/24, 1 successors, FD is 3328
   via 38.38.38.38 (3328/3072), GigabitEthernet2
P 9.9.9.0/24, 1 successors, FD is 3328
   via 38.38.38.38 (3328/3072), GigabitEthernet2
P 25.25.25.0/24, 0 successors, FD is Infinity
   via 38.38.38.38 (3840/3584), GigabitEthernet2
P 27.27.27.0/24, 1 successors, FD is 3328
   via 38.38.38.38 (3328/3072), GigabitEthernet2
P 38.38.38.0/24, 1 successors, FD is 2816
   via Connected, GigabitEthernet2
P 29.29.29.0/24, 1 successors, FD is 3072
   via 38.38.38.38 (3072/2816), GigabitEthernet2
P 33.33.33.0/24, 1 successors, FD is 3840
   via 38.38.38.38 (3840/3584), GigabitEthernet2
    
```

```
P 8.8.8.0/24, 1 successors, FD is 3584
    via 38.38.38.38 (3584/3328), GigabitEthernet2
P 53.53.53.0/24, 1 successors, FD is 2816
    via Connected, GigabitEthernet4
```

ISRV2 After the Failure

```
ISRV2# show standby brief
```

```
          P indicates configured to preempt.
          |
Interface  Grp  Pri  P State   Active      Standby      Virtual IP
Gi3        25   100 P Active local      unknown     192.0.2.222
```

Failure Points	Sequence of Events
<p>WAN Net2 failure (WAN SRIOV VF connected to ISRV2 is down)</p> <ul style="list-style-type: none"> • Link down 	<ol style="list-style-type: none"> 1. ISRV2 on ENCS2 detects the WAN connection failure. This failure is detected when the interface goes down due to VF going down or the track object going down. 2. WAN-IP2 becomes unreachable, and all the routes converge towards WAN-IP1 on ENCS1. WAN-IP1 is the only IP for branch connectivity. 3. All the WAN to LAN and LAN to WAN traffic will now flow through ENCS1.
<p>Transit link between ENCS1 and ENCS2 fails</p> <ul style="list-style-type: none"> • Link down 	<ol style="list-style-type: none"> 1. ISRV2 on ENCS2 detects the link going down due to VF going down or connection failure. The connection failure is detected by the track object. Then, ENCS2 WAN-IP2 link with EEM script is shut down. 2. WAN-IP2 becomes unreachable, and all the routes converge towards WAN-IP1 on ENCS1. WAN-IP1 is the only IP for branch connectivity. 3. All the WAN to LAN and LAN to WAN traffic will now flow through ENCS1.



CHAPTER 12

Cisco ENCS Single WAN IP Deployment Scenarios

- [Single WAN IP Deployment, on page 113](#)
- [Preconfiguring the Cisco ENCS for a Single WAN IP Deployment, on page 114](#)
- [Single WAN IP Deployment with Gigabit Ethernet Interface 0/0, on page 115](#)
- [Single WAN IP Deployment with the 4G Interface, on page 116](#)

Single WAN IP Deployment

A single WAN IP deployment can be considered when the Cisco ENCS is preconfigured at the corporate main office with the service provider's WAN IP address, and shipped to the branch office for quick deployment. At the branch office, you do not have to perform any installation or configuration task. You just have to boot the system with the preconfigured setup. The single WAN IP deployment scenario could vary as per customer requirements. The following are two sample single WAN IP deployment scenarios with the Cisco ISRv:



Note Ensure that you preconfigure the Cisco ENCS at the main office before shipping the device to the branch office. You cannot connect to the remote branch office from your main office in a single WAN IP deployment scenario.

- Single WAN IP Deployment with Gigabit Ethernet Interface
- Single WAN IP Deployment with the 4G Interface

For details, see the Dynamic Multipoint VPN Configuration Guide https://www.cisco.com/c/en/us/td/docs/ios-xml/ios/sec_conn_dmvpn/configuration/xr-16/sec-conn-dmvpn-xr-16-book.html.

Single WAN IP Deployment with Gigabit Ethernet Interface 0/0

In this scenario, two Gigabit Ethernet interfaces are configured on the Cisco ISRV: Gigabit Ethernet2 as the outbound interface and Gigabit Ethernet3 as the internal interface. The outbound interface IP address is provided by the service provider. The internal interface is the WAN interface that serves as the default gateway for Cisco Enterprise NFWIS.

```
crypto isakmp policy 5
 authentication pre-share
 group 2
crypto isakmp key dmvpnkey address 0.0.0.0

crypto ipsec transform-set dmvpnset esp-3des esp-sha-hmac
 mode tunnel

crypto ipsec profile dmvpnprof
 set security-association lifetime seconds 1200
 set transform-set dmvpnset

! DMVPN tunnel configuration
interface Tunnel100
 ip address 192.0.2.3 255.255.255.0
 no ip redirects
 ip mtu 1440
 ip nhrp authentication dmvpnkey
 ip nhrp map 192.0.2.1 198.51.100.1
 ip nhrp network-id 90
 ip nhrp nhs 192.0.2.2
 tunnel source GigabitEthernet2
 tunnel mode gre multipoint
 tunnel key 100000
 tunnel protection ipsec profile dmvpnprof
!
interface GigabitEthernet2
 description this is the outbound interface
 ip address 198.51.100.2 255.255.0.0

interface GigabitEthernet3
 description this is the inside interface
 ip address 192.0.2.10 255.255.255.0
!

router eigrp 90
 network 10.4.76.0 0.0.0.255
 network 192.0.2.1
 eigrp stub connected
 no auto-summary
!
ip route 20.1.0.0 255.255.0.0 198.51.100.1
!|
Smart license configuration

ip name-server 198.51.100.9
ip domain lookup
service internal
do test license smart dev-cert Enable
```

```

service call-home
call-home
contact-email-addr callhome@cisco.com
mail-server 192.0.2.8 priority 1
alert-group-config snapshot
add-command "show license tech su"
profile "CiscoTAC-1"
active
no destination transport-method email
destination transport-method http
no destination address http https://tools.cisco.com/its/service/oddce/services/DDCEService

destination address http http://10.22.183.117:8080/ddce/services/DDCEService
!
clock timezone PST -7
ntp server 192.0.2.9
do license smart register idtoken NDM1NjE1MDAtNDViZC00ZTQ5LTg4MGEtNmRj
Njg2Mjg5ZDV1LTE0OTg5NDk2%0ANjEzNzd8elk5SEtoL2pMTGtuNSs3Q3Jxd
GVoSUVpTmFnY2l0a1VqR3B5MzFj%0AVWVrST0%3D%0A

```

Single WAN IP Deployment with the 4G Interface

In this scenario, a 4G interface (NIM card) is configured as the outbound interface and Gigabit Ethernet3 as the internal interface. The outbound interface IP address is provided by the service provider. The internal interface is the WAN interface that serves as the default gateway for Cisco Enterprise NFVIS.

```

License Level: ax
License Type: N/A(Smart License Enabled)
Next reload license Level: ax

service timestamps debug datetime msec
service timestamps log datetime msec
service internal
service call-home
no platform punt-keepalive disable-kernel-core
platform console virtual
platform hardware throughput level MB 1000
!
hostname ISRV
!
boot-start-marker
boot system bootflash:isrv-universalk9.16.03.02.SPA.bin
boot-end-marker

clock timezone PST -7 0
call-home
contact-email-addr callhome@cisco.com
mail-server 192.0.2.8 priority 1
alert-group-config snapshot
add-command "show license tech su"
profile "CiscoTAC-1"
active
destination transport-method http
no destination transport-method email
destination address http
http://198.51.100.4/Transportgateway/services/DeviceRequestHandler
no destination address http
https://tools.cisco.com/its/service/oddce/services/DDCEService
!
ip name-server 198.51.100.2

```

```

ip domain name cisco.com

! IPsec configuration

crypto isakmp policy 5
 authentication pre-share
 group 2
crypto isakmp key dmvpnkey address 0.0.0.0
!
!
crypto ipsec transform-set dmvpnset esp-3des esp-sha-hmac
 mode tunnel
!
!
crypto ipsec profile dmvpnprof
 set security-association lifetime seconds 1200
 set transform-set dmvpnset
!
!4G interface
controller Cellular 0/2/0
 lte modem link-recovery rssi onset-threshold -110
 lte modem link-recovery monitor-timer 20
 lte modem link-recovery wait-timer 10
 lte modem link-recovery debounce-count 6
!
!
!
no ip ftp passive
ip ftp username admin
ip ftp password admin
!DMVPN tunnel configuration

interface Tunnel100
 ip address 198.51.100.3 255.255.255.0
 no ip redirects
 ip mtu 1440
 ip nhrp authentication dmvpnkey
 ip nhrp map 198.51.100.5 192.0.2.7
 ip nhrp network-id 90
 ip nhrp nhs 198.51.100.5
 tunnel source Cellular0/2/0
 tunnel mode gre multipoint
 tunnel key 100000
 tunnel protection ipsec profile dmvpnprof
!
!
interface GigabitEthernet2
 ip address 198.51.100.6 255.255.255.0
 ip nat inside
 negotiation auto
!
interface GigabitEthernet3
 ip address 198.51.100.11 255.255.255.0
 negotiation auto
!
interface Cellular0/2/0
 ip address negotiated
 load-interval 30
 dialer in-band
 dialer idle-timeout 0
 dialer-group 1
 ipv6 address autoconfig
 pulse-time 1

```

```
!  
interface Cellular0/2/1  
  no ip address  
!  
!  
router eigrp 90  
  network 198.51.100.0 0.0.0.255  
  network 198.52.100.0 0.0.0.255  
  network 99.0.0.0  
  eigrp stub connected  
!  
!  
virtual-service csr_mgmt  
  ip shared host-interface GigabitEthernet1  
  activate  
!  
ip forward-protocol nd  
ip http server  
ip http authentication local  
ip http secure-server  
!  
ip route 0.0.0.0 0.0.0.0 Cellular0/2/0  
ip route 192.0.2.12 255.255.255.0 198.51.100.5  
ip route 192.0.2.13 255.255.255.255 198.51.100.5  
ip route 192.0.2.14 255.255.255.255 198.51.100.5  
ip route 192.0.2.15 255.255.255.255 198.51.100.5  
ip route vrf Mgmt-intf 0.0.0.0 0.0.0.0 198.51.100.20  
ip ssh authentication-retries 5  
ip ssh rsa keypair-name ssh-key  
ip ssh version 2  
ip scp server enable  
!  
dialer-list 1 protocol ip permit  
!  
!  
line con 0  
  stopbits 1  
line vty 0 4  
  password cisco123  
  login local  
  transport input telnet ssh  
!  
ntp server 198.51.100.17
```



CHAPTER 13

Resetting to Factory Default

You can reset the host server to factory default with the following three options :

- **Reset all**—Deletes VMs and volumes, files including logs, images, and certificates. Erases all configuration. Connectivity will be lost, and the admin password will be changed to factory default password..
- **Reset all (except images)**—Deletes VMs and volumes, files including logs, images, and certificates. Erases all configuration except images. Connectivity will be lost, and the admin password will be changed to factory default password..
- **Reset all (except images and connectivity)**—Deletes VMs and volumes, files including logs and certificates. Erases all configuration except images, network, and connectivity.



Note This option must be used only for troubleshooting purpose. We recommend you contact Cisco Technical Support before choosing this option. This option will reboot the system. Do not perform any operations for at least twenty minutes until the system is rebooted successfully.

To reset to factory default:

```
configure terminal
factory-default-reset all
```



Note Click **Yes** when you are prompted with the factory default warning message.

Factory Default APIs and Commands

Factory Default APIs	Factory Default Commands
<ul style="list-style-type: none">• /api/operations/factory-default-reset/all• /api/operations/factory-default-reset/all-except-images• /api/operations/factory-default-reset/all-except-images-connectivity	<ul style="list-style-type: none">• factory-default-reset



CHAPTER 14

Event Notifications

Cisco Enterprise NFVIS generates event notifications for key events. A NETCONF client can subscribe to these notifications for monitoring the progress of configuration activation and the status change of the system and VMs.

There are two types of event notifications: `nfvisEvent` and `vmlcEvent` (VM life cycle event)

To receive event notifications automatically, you can run the NETCONF client, and subscribe to these notifications using the following NETCONF operations:

- `--create-subscription=nfvisEvent`
- `--create-subscription=vmlcEvent`

You can view NFVIS and VM life cycle event notifications using the **`show notification stream nfvisEvent`** and **`show notification stream vmlcEvent`** commands respectively.

- [nfvisEvent, on page 122](#)
- [vmlcEvent, on page 133](#)

nfvisEvent

Event Type	Notification Trigger	Notification Output Example
WAN_DHCP_RENEW	DHCP renew operation is performed.	<pre><?xml version="1.0" encoding="UTF-8"?> <notification xmlns="urn:ietf:params:xml:ns:netconf:notification:1.0"> <eventTime>2017-04-26T18:06:46.142089+00:00</eventTime> <nfvisEvent xmlns="http://www.cisco.com/nfvis/notifier"> <user_id>NA</user_id> <config_change>>false</config_change> <transaction_id>0</transaction_id> <status>SUCCESS</status> <status_code>0</status_code> <status_message>Wan DHCP IP address is being renewed</status_message> <details>NA</details> <event_type>WAN_DHCP_RENEW</event_type> </nfvisEvent> </notification></pre>
BRIDGE_DHCP_RENEW	Bridge DHCP renew operation is performed.	<pre><?xml version="1.0" encoding="UTF-8"?> <notification xmlns="urn:ietf:params:xml:ns:netconf:notification:1.0"> <eventTime>2018-04-26T09:47:06.066264+00:00</eventTime> <nfvisEvent xmlns="http://www.cisco.com/nfvis/notifier"> <user_id>NA</user_id> <config_change>>false</config_change> <transaction_id>0</transaction_id> <status>SUCCESS</status> <status_code>0</status_code> <status_message>Bridge DHCP IP address is being renewed</status_message> <details>NA</details> <event_type>BRIDGE_DHCP_RENEW</event_type> </nfvisEvent> </notification></pre>
INTF_STATUS_CHANGE	Interface status is changed.	<pre><?xml version="1.0" encoding="UTF-8"?> <notification xmlns="urn:ietf:params:xml:ns:netconf:notification:1.0"> <eventTime>2017-04-26T18:12:09.963556+00:00</eventTime> <nfvisEvent xmlns="http://www.cisco.com/nfvis/notifier"> <event_type>INTF_STATUS_CHANGE</event_type> <intf_name>eth7</intf_name> <intf_prv_op>up</intf_prv_op> <intf_op>down</intf_op> <intf_prv_link>down</intf_prv_link> <intf_link>down</intf_link> </nfvisEvent> </notification></pre>

Event Type	Notification Trigger	Notification Output Example
NETWORK_CREATE	A network is created.	<pre><?xml version="1.0" encoding="UTF-8"?> <notification xmlns="urn:ietf:params:xml:ns:netconf:notification:1.0"> <eventTime>2016-09-22T12:41:04.564298+00:00</eventTime> <nfvisEvent xmlns="http://www.cisco.com/nfvis/notifier"> <user_id>admin</user_id> <config_change>true</config_change> <transaction_id>0</transaction_id> <status>SUCCESS</status> <status_message>Network created succesfully</status_message> <event_type>NETWORK_CREATE</event_type> <network_name>testn1</network_name> <network_bridge>test-net-br</network_bridge> <network_sriov>false</network_sriov> <network_vlan/> <network_trunk/> </nfvisEvent> </notification></pre>
NETWORK_UPDATE	A network is updated.	<pre><?xml version="1.0" encoding="UTF-8"?> <notification xmlns="urn:ietf:params:xml:ns:netconf:notification:1.0"> <eventTime>2016-09-22T12:42:03.391986+00:00</eventTime> <nfvisEvent xmlns="http://www.cisco.com/nfvis/notifier"> <user_id>admin</user_id> <config_change>true</config_change> <transaction_id>0</transaction_id> <status>SUCCESS</status> <status_message>Network updated succesfully</status_message> <event_type>NETWORK_UPDATE</event_type> <network_name>testn1</network_name> <network_bridge/> <network_sriov/> <network_vlan/> <network_trunk/> </nfvisEvent> </notification></pre>

Event Type	Notification Trigger	Notification Output Example
NETWORK_DELETE	A network is deleted.	<pre><?xml version="1.0" encoding="UTF-8"?> <notification xmlns="urn:ietf:params:xml:ns:netconf:notification:1.0"> <eventTime>2016-09-22T12:42:03.391986+00:00</eventTime> <nfvisEvent xmlns="http://www.cisco.com/nfvis/notifier"> <user_id>admin</user_id> <config_change>true</config_change> <transaction_id>0</transaction_id> <status>SUCCESS</status> <status_message>Network deleted succesfully</status_message> <event_type>NETWORK_DELETE</event_type> <network_name>testnl</network_name> <network_bridge/> <network_sriov/> <network_vlan/> <network_trunk/> </nfvisEvent> </notification></pre>
UPGRADE_REGISTER	System upgrade is registered.	<pre><?xml version="1.0" encoding="UTF-8"?> <notification xmlns="urn:ietf:params:xml:ns:netconf:notification:1.0"> <eventTime>2017-04-26T15:57:50.434636+00:00</eventTime> <nfvisEvent xmlns="http://www.cisco.com/nfvis/notifier"> <user_id>NA</user_id> <config_change>true</config_change> <transaction_id>0</transaction_id> <status>SUCCESS</status> <status_code>0</status_code> <status_message>Upgrade package registration successful: Cisco_NFVIS_Upgrade-3.6.1-698-20170402_042811.nfvispkg</status_message> <event_type>UPGRADE_REGISTER</event_type> </nfvisEvent> </notification></pre>
UPGRADE_APPLY	System upgrade is applied.	<pre><?xml version="1.0" encoding="UTF-8"?> <notification xmlns="urn:ietf:params:xml:ns:netconf:notification:1.0"> <eventTime>2017-04-26T16:02:43.885516+00:00</eventTime> <nfvisEvent xmlns="http://www.cisco.com/nfvis/notifier"> <user_id>NA</user_id> <config_change>true</config_change> <transaction_id>0</transaction_id> <status>SUCCESS</status> <status_code>0</status_code> <status_message>Upgrade Process: In Progress</status_message> <event_type>UPGRADE_APPLY</event_type> </nfvisEvent> </notification></pre>

Event Type	Notification Trigger	Notification Output Example
ROTATED_LOGS_DELETE	Rotated logs older than 30 days are deleted by the system.	<pre><?xml version="1.0" encoding="UTF-8"?> <rpc-reply xmlns="urn:ietf:params:xml:ns:netconf:base:1.0" message-id="1"> <ok/> </rpc-reply> <?xml version="1.0" encoding="UTF-8"?> <notification xmlns="urn:ietf:params:xml:ns:netconf:notification:1.0"> <eventTime>2017-04-26T17:38:10.321152+00:00</eventTime> <nfvisEvent xmlns="http://www.cisco.com/nfvis/notifier"> <user_id>NA</user_id> <config_change>true</config_change> <transaction_id>0</transaction_id> <status>SUCCESS</status> <status_code>0</status_code> <status_message>Deleted rotated logs from archive older than 30 days</status_message> <details>NA</details> <event_type>ROTATED_LOGS_DELETE</event_type> </nfvisEvent> </notification></pre>
ROTATED_LOGS_DELETE	Older logs deleted by the system when the total file size of rotated logs exceeds 2GB.	<pre><?xml version="1.0" encoding="UTF-8"?> <rpc-reply xmlns="urn:ietf:params:xml:ns:netconf:base:1.0" message-id="1"> <ok/> </rpc-reply> <?xml version="1.0" encoding="UTF-8"?> <notification xmlns="urn:ietf:params:xml:ns:netconf:notification:1.0"> <eventTime>2017-04-26T17:42:10.321152+00:00</eventTime> <nfvisEvent xmlns="http://www.cisco.com/nfvis/notifier"> <user_id>NA</user_id> <config_change>true</config_change> <transaction_id>0</transaction_id> <status>SUCCESS</status> <status_code>0</status_code> <status_message>Rotated logs had exceeded 2G, older logs have been deleted to make space</status_message> <details>NA</details> <event_type>ROTATED_LOGS_DELETE</event_type> </nfvisEvent> </notification></pre>

Event Type	Notification Trigger	Notification Output Example
SECUREOVLAYCRNG	create secure overlay	<pre> <notification <eventTime> 2018-11-02T04:23:02.641317+00:00 <nfvisEvent <user_id>admin</user_id> <config_change>>true</config_change> <transaction_id>0</transaction_id> <status>SUCCESS</status> <status_code>0</status_code> <status_message>Secure Overlay mgmthub initial creation. Active local bridge: wan-br</status_message> <details>NA</details> <event_type>SECURE_OVERLAY_CREATING</event_type> <severity> INFO</severity> <hostname>nfvis</hostname> </nfvisEvent> </notification> </pre>
SECUREOVLAYUP	Secure Overlay is UP	<pre> <?xml version="1.0" encoding="UTF-8"?> <notification xmlns="urn:ietf:params:xml:ns:netconf:notification:1.0"> <eventTime>2018-04-26T09:47:06.066264+00:00</eventTime> <nfvisEvent xmlns="http://www.cisco.com/nfvis/notifier"> <user_id>admin</user_id> <config_change>true</config_change> <transaction_id>0</transaction_id> <status>SUCCESS</status> <status_code>0</status_code> <status_message>Secure Overlay mgmthub up. Active bridge: wan-br</status_message> <details>Secure overlay initial creation</details> <event_type>SECURE_OVERLAY_UP</event_type> <severity>INFO</severity> <hostname>NFVIS</hostname> </nfvisEvent> </notification> </pre>

Event Type	Notification Trigger	Notification Output Example
<u>WAN_DHCP_SWITCHOVER</u>	WAN bridge toggle	<pre><?xml version="1.0" encoding="UTF-8"?> <notification xmlns="urn:ietf:params:xml:ns:netconf:notification:1.0"> <eventTime>2018-04-26T09:47:06.066264+00:00</eventTime> <nfvisEvent xmlns="http://www.cisco.com/nfvis/notifier"> <user_id>admin</user_id> <config_change>true</config_change> <transaction_id>0</transaction_id> <status>SUCCESS</status> <status_code>0</status_code> <status_message>Switch over to bridge wan2-br for auto DHCP enablement successful</status_message> <details>NA</details> <event_type>WAN_DHCP_SWITCHOVER</event_type> <severity>INFO</severity> <hostname>NFVIS</hostname> </nfvisEvent> </notification></pre>
<u>WAN_DHCP_TOGGLE_END</u>	WAN bridge toggle	<pre><?xml version="1.0" encoding="UTF-8"?> <notification xmlns="urn:ietf:params:xml:ns:netconf:notification:1.0"> <eventTime>2018-04-26T09:47:06.066264+00:00</eventTime> <nfvisEvent xmlns="http://www.cisco.com/nfvis/notifier"> <user_id>admin</user_id> <config_change>true</config_change> <transaction_id>0</transaction_id> <status>SUCCESS</status> <status_code>0</status_code> <status_message>Disabling bridge toggle for auto DHCP enablement.</status_message> <details>NA</details> <event_type>WAN_DHCP_TOGGLE_END</event_type> <severity>INFO</severity> <hostname>NFVIS</hostname> </nfvisEvent> </notification></pre>

Event Type	Notification Trigger	Notification Output Example
ROUTE_DISTRIBUTION_START	To start route distribution	<pre> <?xml version="1.0" encoding="UTF-8"?> <notification xmlns="urn:ietf:params:xml:ns:netconf:notification:1.0"> <eventTime>2019-03-15T21:46:28.034133+00:00</eventTime> <nfvisEvent xmlns="http://www.cisco.com/nfvis/notifier"> <user_id>admin</user_id> <config_change>true</config_change> <transaction_id>0</transaction_id> <status>SUCCESS</status> <status_code>0</status_code> <status_message>Route Distribution initial creation. Neighbor Address: 172.25.221.106</status_message> <details>NA</details> <event_type>ROUTE_DISTRIBUTION_START</event_type> <severity>INFO</severity> <hostname>NFVIS</hostname> </nfvisEvent> </notification> </pre>
ROUTE_DISTRIBUTION_DOWN	Route distribution is down	<pre> <?xml version="1.0" encoding="UTF-8"?> <notification xmlns="urn:ietf:params:xml:ns:netconf:notification:1.0"> <eventTime>2019-03-15T21:46:28.034133+00:00</eventTime> <nfvisEvent xmlns="http://www.cisco.com/nfvis/notifier"> <user_id>admin</user_id> <config_change>true</config_change> <transaction_id>0</transaction_id> <status>SUCCESS</status> <status_code>0</status_code> <status_message>Neighbor Address: 172.25.221.106</status_message> <details>NA</details> <event_type>ROUTE_DISTRIBUTION_DOWN</event_type> <severity>INFO</severity> <hostname>NFVIS</hostname> </nfvisEvent> </notification> </pre>

Event Type	Notification Trigger	Notification Output Example
ROUTE_DISTR ROUTE_DISTR_ERROR	Route distribution in error	<pre><?xml version="1.0" encoding="UTF-8"?> <notification xmlns="urn:ietf:params:xml:ns:netconf:notification:1.0"> <eventTime>2019-03-15T21:46:28.034133+00:00</eventTime> <nfvisEvent xmlns="http://www.cisco.com/nfvis/notifier"> <user_id>admin</user_id> <config_change>true</config_change> <transaction_id>0</transaction_id> <status>SUCCESS</status> <status_code>0</status_code> <status_message>Neighbor Address: 172.25.221.106</status_message> <details>NA</details> <event_type>ROUTE_DISTRIBUTION_ERROR</event_type> <severity>INFO</severity> <hostname>NFVIS</hostname> </nfvisEvent> </notification></pre>
ROUTE_DISTR ROUTE_DISTR_DELETE	Route distribution deleted	<pre><?xml version="1.0" encoding="UTF-8"?> <notification xmlns="urn:ietf:params:xml:ns:netconf:notification:1.0"> <eventTime>2019-03-15T21:46:28.034133+00:00</eventTime> <nfvisEvent xmlns="http://www.cisco.com/nfvis/notifier"> <user_id>admin</user_id> <config_change>true</config_change> <transaction_id>0</transaction_id> <status>SUCCESS</status> <status_code>0</status_code> <status_message>All Neighbor Addresses deleted</status_message> <details>NA</details> <event_type>ROUTE_DISTRIBUTION_DELETE</event_type> <severity>INFO</severity> <hostname>NFVIS</hostname> </nfvisEvent> </notification></pre>

Event Type	Notification Trigger	Notification Output Example
ROUTE_DISTRIBUTION_UP	Route distribution up	<pre><?xml version="1.0" encoding="UTF-8"?> <notification xmlns="urn:ietf:params:xml:ns:netconf:notification:1.0"> <eventTime>2019-03-15T21:46:28.034133+00:00</eventTime> <nfvisEvent xmlns="http://www.cisco.com/nfvis/notifier"> <user_id>admin</user_id> <config_change>true</config_change> <transaction_id>0</transaction_id> <status>SUCCESS</status> <status_code>0</status_code> <status_message>Neighbor Address: 172.25.221.106</status_message> <details>NA</details> <event_type>ROUTE_DISTRIBUTION_UP</event_type> <severity>INFO</severity> <hostname>NFVIS</hostname> </nfvisEvent> </notification></pre>
OVS_DPK_SUCCESS	Enable DPK	<pre><?xml version="1.0" encoding="UTF-8"?> <notification xmlns="urn:ietf:params:xml:ns:netconf:notification:1.0"> <eventTime>2019-03-15T21:46:28.034133+00:00</eventTime> <nfvisEvent xmlns="http://www.cisco.com/nfvis/notifier"> <user_id>admin</user_id> <config_change>>false</config_change> <transaction_id>0</transaction_id> <status>SUCCESS</status> <status_code>0</status_code> <status_message>OVS-DPDK enabled</status_message> <details>NA</details> <event_type>OVS_DPK_SUCCESS</event_type> <severity>INFO</severity> <hostname>NFVIS</hostname> </nfvisEvent> </notification></pre>
OVS_DPK_FAILURE	DPDK failure	<pre><?xml version="1.0" encoding="UTF-8"?> <notification xmlns="urn:ietf:params:xml:ns:netconf:notification:1.0"> <eventTime>2019-03-15T21:46:28.034133+00:00</eventTime> <nfvisEvent xmlns="http://www.cisco.com/nfvis/notifier"> <user_id>admin</user_id> <config_change>>false</config_change> <transaction_id>0</transaction_id> <status>SUCCESS</status> <status_code>0</status_code> <status_message>Unable to allocate CPU</status_message> <details>NA</details> <event_type>OVS_DPK_FAILURE</event_type> <severity>INFO</severity> <hostname>NFVIS</hostname> </nfvisEvent> </notification></pre>

Event Type	Notification Trigger	Notification Output Example
PNIC_SRIOV_ENABLE	Enable SR-IOV to 2 vfs	<pre data-bbox="678 348 1422 827"><?xml version="1.0" encoding="UTF-8"?> <notification xmlns="urn:ietf:params:xml:ns:netconf:notification:1.0"> <eventTime>2019-03-15T21:46:28.034133+00:00</eventTime> <nfvisEvent xmlns="http://www.cisco.com/nfvis/notifier"> <user_id>admin</user_id> <config_change>true</config_change> <transaction_id>0</transaction_id> <status>SUCCESS</status> <status_code>0</status_code> <status_message>Physical Interface: eth0-1 Number of VFs 2</status_message> <details>NA</details> <event_type>PNIC_SRIOV_ENABLE</event_type> <severity>INFO</severity> <hostname>NFVIS</hostname> </nfvisEvent> </notification></pre>
PNIC_SRIOV_DISABLE	Disable SR-IOV	<pre data-bbox="678 886 1422 1362"><?xml version="1.0" encoding="UTF-8"?> <notification xmlns="urn:ietf:params:xml:ns:netconf:notification:1.0"> <eventTime>2019-03-15T21:46:28.034133+00:00</eventTime> <nfvisEvent xmlns="http://www.cisco.com/nfvis/notifier"> <user_id>admin</user_id> <config_change>true</config_change> <transaction_id>0</transaction_id> <status>SUCCESS</status> <status_code>0</status_code> <status_message>Physical Interface: eth0-1 Number of VFs 0</status_message> <details>NA</details> <event_type>PNIC_SRIOV_DISABLE</event_type> <severity>INFO</severity> <hostname>NFVIS</hostname> </nfvisEvent> </notification></pre>

Event Type	Notification Trigger	Notification Output Example
PNCSRIOV_ENABLE	Enable of disable SR-IOV in error	<pre> <?xml version="1.0" encoding="UTF-8"?> <notification xmlns="urn:ietf:params:xml:ns:netconf:notification:1.0"> <eventTime>2019-03-15T21:46:28.034133+00:00</eventTime> <nfvisEvent xmlns="http://www.cisco.com/nfvis/notifier"> <user_id>admin</user_id> <config_change>true</config_change> <transaction_id>0</transaction_id> <status>SUCCESS</status> <status_code>0</status_code> <status_message>Physical Interface: eth0-1 Number of VFs 2</status_message> <details>NA</details> <event_type>PNIC_SRIOV_ENABLE</event_type> <severity>INFO</severity> <hostname>NFVIS</hostname> </nfvisEvent> </notification> </pre>
PNCSRIOV_UPDATE	Set switchmode to veb/vepa	<pre> <?xml version="1.0" encoding="UTF-8"?> <notification xmlns="urn:ietf:params:xml:ns:netconf:notification:1.0"> <eventTime>2019-03-15T21:46:28.034133+00:00</eventTime> <nfvisEvent xmlns="http://www.cisco.com/nfvis/notifier"> <user_id>admin</user_id> <config_change>true</config_change> <transaction_id>0</transaction_id> <status>SUCCESS</status> <status_code>0</status_code> <status_message>Physical Interface: eth0-1 Switchmode vepa</status_message> <details>NA</details> <event_type>PNIC_SRIOV_UPDATE</event_type> <severity>INFO</severity> <hostname>NFVIS</hostname> </nfvisEvent> </notification> </pre>

Event Type	Notification Trigger	Notification Output Example
PNIC_SRIOV_UPDATE	Set switchmode to veb/vepa in error	<pre><?xml version="1.0" encoding="UTF-8"?> <notification xmlns="urn:ietf:params:xml:ns:netconf:notification:1.0"> <eventTime>2019-03-15T21:46:28.034133+00:00</eventTime> <nfvisevent xmlns="http://www.cisco.com/nfvisevent/notifier"> <user_id>admin</user_id> <config_change>true</config_change> <transaction_id>0</transaction_id> <status>SUCCESS</status> <status_code>0</status_code> <status_message>Physical Interface: eth0-1 Switchmode vepa</status_message> <details>NA</details> <event_type>PNIC_SRIOV_UPDATE</event_type> <severity>INFO</severity> <hostname>NFVIS</hostname> </nfvisevent> </notification></pre>

vmlcEvent

Event Type	Notification Trigger	Notification Output Example
CREATE_IMAGE	The VM image is registered.	<pre><?xml version="1.0" encoding="UTF-8"?> <notification xmlns="urn:ietf:params:xml:ns:netconf:notification:1.0"> <eventTime>2016-11-17T17:12:30.76+00:00</eventTime> <vmlcEvent xmlns="http://www.cisco.com/nfvisevent/vm_lifecycle"> <status>SUCCESS</status> <status_code>200</status_code> <status_message>Image creation completed successfully.</status_message> <image>isrv-universalk9.16.03.01.tar.gz</image> <vm_source></vm_source> <vm_target></vm_target> <event> <type>CREATE_IMAGE</type> </event> </vmlcEvent> </notification></pre>

Event Type	Notification Trigger	Notification Output Example
DELETE_IMAGE	The VM image is unregistered.	<pre><?xml version="1.0" encoding="UTF-8"?> <notification xmlns="urn:ietf:params:xml:ns:netconf:notification:1.0"> <eventTime>2016-11-17T17:14:51.169+00:00</eventTime> <vmlcEvent xmlns="http://www.cisco.com/nfvis/vm_lifecycle"> <status>SUCCESS</status> <status_code>200</status_code> <status_message>Image deletion completed successfully.</status_message> <image>isrv-universalk9.16.03.01.tar.gz</image> <vm_source></vm_source> <vm_target></vm_target> <event> <type>DELETE_IMAGE</type> </event> </vmlcEvent> </notification></pre>
CREATE_FLAVOR	A flavor is created.	<pre><?xml version="1.0" encoding="UTF-8"?> <notification xmlns="urn:ietf:params:xml:ns:netconf:notification:1.0"> <eventTime>2016-11-17T17:12:29.685+00:00</eventTime> <vmlcEvent xmlns="http://www.cisco.com/nfvis/vm_lifecycle"> <status>SUCCESS</status> <status_code>200</status_code> <status_message>Flavor creation completed successfully.</status_message> <flavor>ISRV-small</flavor> <vm_source></vm_source> <vm_target></vm_target> <event> <type>CREATE_FLAVOR</type> </event> </vmlcEvent> </notification></pre>
DELETE_FLAVOR	A flavor is deleted.	<pre><?xml version="1.0" encoding="UTF-8"?> <notification xmlns="urn:ietf:params:xml:ns:netconf:notification:1.0"> <eventTime>2016-11-17T17:14:51.425+00:00</eventTime> <vmlcEvent xmlns="http://www.cisco.com/nfvis/vm_lifecycle"> <status>SUCCESS</status> <status_code>200</status_code> <status_message>Flavor deletion completed successfully.</status_message> <flavor>ISRV-small</flavor> <vm_source></vm_source> <vm_target></vm_target> <event> <type>DELETE_FLAVOR</type> </event> </vmlcEvent> </notification></pre>

Event Type	Notification Trigger	Notification Output Example
VM_DEPLOYED	The VM is deployed.	<pre> <?xml version="1.0" encoding="UTF-8"?> <notification xmlns="urn:ietf:params:xml:ns:netconf:notification:1.0"> <eventTime>2016-11-17T17:19:16.927+00:00</eventTime> <vmlcEvent xmlns="http://www.cisco.com/nfvis/vm_lifecycle"> <status>SUCCESS</status> <status_code>200</status_code> <status_message>VIM Driver: VM successfully created, VM Name: [SystemAdminTena_ROUTER_0_df6733c1-0768-4ae6-8dce-b223ecdb036c]</status_message> <depname>1479341445</depname> <tenant>admin</tenant> <tenant_id>AdminTenantId</tenant_id> <depid>c64d79db-3a29-41a8-8114-c80d42731a5b</depid> <vm_group>ROUTER</vm_group> <vm_source> <vmid>d18dd252-80c8-44f2-ab66-d4481790bb79</vmid> <hostid>NFVIS</hostid> <hostname>NFVIS</hostname> <interfaces> <interface> <nicid>0</nicid> <port_id>vnet0</port_id> <network>int-mgmt-net</network> <subnet>N/A</subnet> <ip_address>10.20.0.2</ip_address> <mac_address>52:54:00:31:c5:7f</mac_address> <netmask>255.255.255.0</netmask> <gateway>10.20.0.1</gateway> </interface> <interface> <nicid>1</nicid> <port_id>vnet1</port_id> <network>wan-net</network> <subnet>N/A</subnet> <mac_address>52:54:00:59:52:41</mac_address> <netmask>255.255.255.0</netmask> <gateway>172.19.181.152</gateway> </interface> </interfaces> </vm_source> <vm_target></vm_target> </vmlcEvent> </notification> </pre>

Event Type	Notification Trigger	Notification Output Example
VM_ALIVE	The state of a monitored VM becomes ACTIVE.	<pre> <?xml version="1.0" encoding="UTF-8"?> <notification xmlns="urn:iETF:params:xml:ns:netconf:notification:1.0"> <eventTime>2016-11-17T17:22:47.306+00:00</eventTime> <vmlcEvent xmlns="http://www.cisco.com/nfvis/vm_lifecycle"> <status>SUCCESS</status> <status_code>200</status_code> <status_message>VM_Alive event received, VM ID: [SystemAdminTena_ROUTER_0_df6733c1-0768-4ae6-8dce-b223ecdb036c]</status_message> <depname>1479341445</depname> <tenant>admin</tenant> <tenant_id>AdminTenantId</tenant_id> <depid>c64d79db-3a29-41a8-8114-c80d42731a5b</depid> <vm_group>ROUTER</vm_group> <vm_source> <vmid>d18dd252-80c8-44f2-ab66-d4481790bb79</vmid> <hostid>NFVIS</hostid> <hostname>NFVIS</hostname> <interfaces> <interface> <nicid>0</nicid> <port_id>vnet0</port_id> <network>int-mgmt-net</network> <subnet>N/A</subnet> <ip_address>10.20.0.2</ip_address> <mac_address>52:54:00:31:c5:7f</mac_address> <netmask>255.255.255.0</netmask> <gateway>10.20.0.1</gateway> </interface> <interface> <nicid>1</nicid> <port_id>vnet1</port_id> <network>wan-net</network> <subnet>N/A</subnet> <mac_address>52:54:00:59:52:41</mac_address> <netmask>255.255.255.0</netmask> <gateway>172.19.181.152</gateway> </interface> </interfaces> </vm_source> <vm_target></vm_target> <event> <type>VM_ALIVE</type> </event> </vmlcEvent> </notification> </pre>

Event Type	Notification Trigger	Notification Output Example
VM_UNDEPLOYED	The VM is undeployed	<pre> <?xml version="1.0" encoding="UTF-8"?> <notification xmlns="urn:ietf:params:xml:ns:netconf:notification:1.0"> <eventTime>2016-11-17T17:31:40.6+00:00</eventTime> <vmlcEvent xmlns="http://www.cisco.com/nfvis/vm_lifecycle"> <status>SUCCESS</status> <status_code>204</status_code> <status_message>VIM Driver: VM successfully deleted</status_message> <depname>1479341445</depname> <tenant>admin</tenant> <tenant_id>AdminTenantId</tenant_id> <depid>c64d79db-3a29-41a8-8114-c80d42731a5b</depid> <vm_group>ROUTER</vm_group> <vm_source> <vmid>d18dd252-80c8-44f2-ab66-d4481790bb79</vmid> <hostid>NFVIS</hostid> <hostname>NFVIS</hostname> <interfaces> <interface> <nicid>0</nicid> <port_id>vnet0</port_id> <network>int-mgmt-net</network> <subnet>N/A</subnet> <ip_address>10.20.0.2</ip_address> <mac_address>52:54:00:31:c5:7f</mac_address> <netmask>255.255.255.0</netmask> <gateway>10.20.0.1</gateway> </interface> <interface> <nicid>1</nicid> <port_id>vnet1</port_id> <network>wan-net</network> <subnet>N/A</subnet> <mac_address>52:54:00:59:52:41</mac_address> <netmask>255.255.255.0</netmask> <gateway>172.19.181.152</gateway> </interface> </interfaces> </vm_source> <vm_target></vm_target> <event> <type>VM_UNDEPLOYED</type> </event> </vmlcEvent> </notification> </pre>

Event Type	Notification Trigger	Notification Output Example
SERVICE_UPDATED	The VM is updated.	<pre><?xml version="1.0" encoding="UTF-8"?> <notification xmlns="urn:ietf:params:xml:ns:netconf:notification:1.0"> <eventTime>2016-11-17T17:51:45.5+00:00</eventTime> <vmlcEvent xmlns="http://www.cisco.com/nfvis/vm_lifecycle"> <status>SUCCESS</status> <status_code>200</status_code> <status_message>Service group update completed successfully</status_message> <depname>1479342258</depname> <tenant>admin</tenant> <tenant_id>AdminTenantId</tenant_id> <depid>827e871a-30d5-4f5f-a05a-263b7ee3a734</depid> <vm_source></vm_source> <vm_target></vm_target> <event> <type>SERVICE_UPDATED</type> </event> </vmlcEvent> </notification></pre>
VM_STOPPED	The VM is stopped per VM action request.	<pre><?xml version="1.0" encoding="UTF-8"?> <notification xmlns="urn:ietf:params:xml:ns:netconf:notification:1.0"> <eventTime>2016-11-17T17:26:05.762+00:00</eventTime> <vmlcEvent xmlns="http://www.cisco.com/nfvis/vm_lifecycle"> <status>SUCCESS</status> <status_code>200</status_code> <status_message>Successfully stopped VM [SystemAdminTena_ROUTER_0_df6733c1-0768-4ae6-8dce-b223ecdb036c].</status_message> <depname>1479341445</depname> <tenant>admin</tenant> <tenant_id>AdminTenantId</tenant_id> <svcid>NULL</svcid> <depid>c64d79db-3a29-41a8-8114-c80d42731a5b</depid> <vm_group>ROUTER</vm_group> <vm_source> <vmid>d18dd252-80c8-44f2-ab66-d4481790bb79</vmid> <hostid>NFVIS</hostid> <hostname>NFVIS</hostname> </vm_source> <vm_target></vm_target> <event> <type>VM_STOPPED</type> </event> </vmlcEvent> </notification></pre>

Event Type	Notification Trigger	Notification Output Example
VM_STARTED	The VM is started per VM action request.	<pre> <?xml version="1.0" encoding="UTF-8"?> <notification xmlns="urn:ietf:params:xml:ns:netconf:notification:1.0"> <eventTime>2016-11-17T17:26:40.398+00:00</eventTime> <vmlcEvent xmlns="http://www.cisco.com/nfvis/vm_lifecycle"> <status>SUCCESS</status> <status_code>200</status_code> <status_message>Started VM [SystemAdminTena_ROUTER_0_df6733c1-0768-4ae6-8dce-b223ecdb036c].</status_message> <depname>1479341445</depname> <tenant>admin</tenant> <tenant_id>AdminTenantId</tenant_id> <svcid>NULL</svcid> <depid>c64d79db-3a29-41a8-8114-c80d42731a5b</depid> <vm_group>ROUTER</vm_group> <vm_source> <vmid>d18dd252-80c8-44f2-ab66-d4481790bb79</vmid> <hostid>NFVIS</hostid> <hostname>NFVIS</hostname> </vm_source> <vm_target></vm_target> <event> <type>VM_STARTED</type> </event> </vmlcEvent> </notification> </pre>

Event Type	Notification Trigger	Notification Output Example
VM_REBOOTED	The VM is rebooted per VM action request.	<pre> <?xml version="1.0" encoding="UTF-8"?> <notification xmlns="urn:ietf:params:xml:ns:netconf:notification:1.0"> <eventTime>2016-11-17T17:36:56.5+00:00</eventTime> <vmlcEvent xmlns="http://www.cisco.com/nfvis/vm_lifecycle"> <status>SUCCESS</status> <status_code>200</status_code> <status_message>Rebooted VM [SystemAdminTena_ROUTER_0_f17fc494-8535-4b05-b88d-f0fd2effdc7d]</status_message> <depname>1479342258</depname> <tenant>admin</tenant> <tenant_id>AdminTenantId</tenant_id> <svcid>NULL</svcid> <depid>827e871a-30d5-4f5f-a05a-263b7ee3a734</depid> <vm_group>ROUTER</vm_group> <vm_source> <vmid>d918a3b1-f2a9-4065-9d8e-2135b0a37d87</vmid> <hostid>NFVIS</hostid> <hostname>NFVIS</hostname> </vm_source> <vm_target></vm_target> <event> <type>VM_REBOOTED</type> </event> </vmlcEvent> </notification> </pre>

Event Type	Notification Trigger	Notification Output Example
VM_RECOVERY_INIT	A monitored VM is not reachable.	<pre> <?xml version="1.0" encoding="UTF-8"?> <notification xmlns="urn:ietf:params:xml:ns:netconf:notification:1.0"> <eventTime>2016-11-17T16:27:51.627+00:00</eventTime> <vmlcEvent xmlns="http://www.cisco.com/nfvis/vm_lifecycle"> <status>SUCCESS</status> <status_code>200</status_code> <status_message>Recovery event for VM [SystemAdminTena_ROUTER_0_40ae18be-5930-4d94-95ff-dbb0b56ef12b] triggered. Processing Auto healing. Proceeding with Recovery.</status_message> <depname>1479328919</depname> <tenant>admin</tenant> <tenant_id>AdminTenantId</tenant_id> <svcid>NULL</svcid> <depid>9e7fe4f8-a5f4-4a6d-aad7-121405be4ba4</depid> <vm_group>ROUTER</vm_group> <vm_source> <vmid>000883fc-77f3-4b9e-aaf6-0f31d88a8f67</vmid> <hostid>NFVIS</hostid> <hostname>NFVIS</hostname> </vm_source> <vm_target></vm_target> <event> <type>VM_RECOVERY_INIT</type> </event> </vmlcEvent> </notification> </pre>

Event Type	Notification Trigger	Notification Output Example
VM_RECOVERY_REBOOT	Recovery reboot starts for the monitored VM, which is not reachable.	<pre> <?xml version="1.0" encoding="UTF-8"?> <notification xmlns="urn:iETF:params:xml:ns:netconf:notification:1.0"> <eventTime>2016-11-17T16:27:53.979+00:00</eventTime> <vmlcEvent xmlns="http://www.cisco.com/nfv/inf/vm_lifecycle"> <status>SUCCESS</status> <status_code>200</status_code> <status_message>VM [SystemAdminTena_ROUTER_0_40ae18be-5930-4d94-95ff-dbb0b56ef12b] is being rebooted. </status_message> <depname>1479328919</depname> <tenant>admin</tenant> <tenant_id>AdminTenantId</tenant_id> <svcid>NULL</svcid> <depid>9e7fe4f8-a5f4-4a6d-aad7-121405be4ba4</depid> <vm_group>ROUTER</vm_group> <vm_source> <vmid>000883fc-77f3-4b9e-aaf6-0f31d88a8f67</vmid> <hostid>NFVIS</hostid> <hostname>NFVIS</hostname> </vm_source> <vm_target></vm_target> <event> <type>VM_RECOVERY_REBOOT</type> </event> </vmlcEvent> </notification> </pre>

Event Type	Notification Trigger	Notification Output Example
VM_RECOVERY_COMPLETE	Recovery reboot completes for the monitored VM, which is not reachable.	<pre> <?xml version="1.0" encoding="UTF-8"?> <notification xmlns="urn:ietf:params:xml:ns:netconf:notification:1.0"> <eventTime>2016-11-17T16:31:26.934+00:00</eventTime> <vmlcEvent xmlns="http://www.cisco.com/nfv/vm_lifecycle"> <status>SUCCESS</status> <status_code>200</status_code> <status_message>Successfully recovered VM [SystemAdminTena_ROUTER_0_40ae18be-5930-4d94-95ff-dbb0b56ef12b].< status_message> <depname>1479328919</depname> <tenant>admin</tenant> <tenant_id>AdminTenantId</tenant_id> <svcid>NULL</svcid> <depid>9e7fe4f8-a5f4-4a6d-aad7-121405be4ba4</depid> <vm_group>ROUTER</vm_group> <vm_source> <vmid>000883fc-77f3-4b9e-aaf6-0f31d88a8f67</vmid> <hostid>NFVIS</hostid> <hostname>NFVIS</hostname> </vm_source> <vm_target> <vmid>000883fc-77f3-4b9e-aaf6-0f31d88a8f67</vmid> <hostid>NFVIS</hostid> <hostname>NFVIS</hostname> <interfaces> <interface> <nicid>0</nicid> <port_id>vnet0</port_id> <network>int-mgmt-net</network> <subnet>N/A</subnet> <ip_address>10.20.0.2</ip_address> <mac_address>52:54:00:7b:3f:de</mac_address> <netmask>255.255.255.0</netmask> <gateway>10.20.0.1</gateway> </interface> <interface> <nicid>1</nicid> <port_id>vnet1</port_id> <network>wan-net</network> <subnet>N/A</subnet> <mac_address>52:54:00:96:8a:4d</mac_address> <netmask>255.255.255.0</netmask> <gateway>172.19.181.152</gateway> </interface> </interfaces> </vm_target> <event> <type>VM_RECOVERY_COMPLETE</type> </event> </vmlcEvent> </notification> </pre>

Event Type	Notification Trigger	Notification Output Example
VMMONCR_UNSET	Monitoring is disabled per VM action request.	<pre> <?xml version="1.0" encoding="UTF-8"?> <notification xmlns="urn:iETF:params:xml:ns:netconf:notification:1.0"> <eventTime>2016-11-18T13:36:43.613+00:00</eventTime> <vmlcEvent xmlns="http://www.cisco.com/nfvis/vm_lifecycle"> <status>SUCCESS</status> <status_code>200</status_code> <status_message>Unset monitor completed successfully</status_message> <depname>1479413090</depname> <tenant>admin</tenant> <tenant_id>AdminTenantId</tenant_id> <svcid>NULL</svcid> <depid>742dd335-330c-4bf0-a75d-a44003c645c5</depid> <vm_group>ROUTER</vm_group> <vm_source> <vmid>23ec3793-37ab-4ec2-a978-a10e08585fdd</vmid> <hostid>NFVIS</hostid> <hostname>NFVIS</hostname> </vm_source> <vm_target></vm_target> <event> <type>VM_MONITOR_UNSET</type> </event> </vmlcEvent> </notification> </pre>
VMMONCR_SET	Monitoring is enabled per VM action request.	<pre> <?xml version="1.0" encoding="UTF-8"?> <notification xmlns="urn:iETF:params:xml:ns:netconf:notification:1.0"> <eventTime>2016-11-18T13:40:15.276+00:00</eventTime> <vmlcEvent xmlns="http://www.cisco.com/nfvis/vm_lifecycle"> <status>SUCCESS</status> <status_code>200</status_code> <status_message>Set monitor completed successfully</status_message> <depname>1479413090</depname> <tenant>admin</tenant> <tenant_id>AdminTenantId</tenant_id> <svcid>NULL</svcid> <depid>742dd335-330c-4bf0-a75d-a44003c645c5</depid> <vm_group>ROUTER</vm_group> <vm_source> <vmid>23ec3793-37ab-4ec2-a978-a10e08585fdd</vmid> <hostid>NFVIS</hostid> <hostname>NFVIS</hostname> </vm_source> <vm_target></vm_target> <event> <type>VM_MONITOR_SET</type> </event> </vmlcEvent> </notification> </pre>

Event Type	Notification Trigger	Notification Output Example
VM_UPDATED	VM's flavor is changed.	

Event Type	Notification Trigger	Notification Output Example
		<pre> <?xml version="1.0" encoding="UTF-8"?> <notification xmlns="urn:iETF:params:xml:ns:netconf:notification:1.0"> <eventTime>2017-12-08T00:50:39.034+00:00</eventTime> <vmlcEvent xmlns='http://www.cisco.com/nfvis/vm_lifecycle'> <status>SUCCESS</status> <status_code>200</status_code> <status_message>VM is resized with flavor [ISRV-medium].</status_message> <user_name>admin</user_name> <depname>1512766000</depname> <tenant>admin</tenant> <tenant_id>adminUUID</tenant_id> <depid>92c11aa1-f6dd-47d1-948f-c8c65b9ef70f</depid> <vm_group>ROUTER</vm_group> <vm_source> <vmid>1a6f587e-2779-4087-b84d-c0a2c8a481b1</vmid> <vmname>1512766000_ROUTER_0_60d15064-0c6d-49b9-aa4a-80587f626004</vmname> <hostid>NFVIS</hostid> <hostname>nfvis</hostname> <interfaces> <interface> <nicid>0</nicid> <type>virtual</type> <port_id>vnic0</port_id> <network>int-mgmt-net</network> <subnet>N/A</subnet> <ip_address>10.20.0.3</ip_address> <mac_address>52:54:00:3c:ee:5b</mac_address> <netmask>255.255.255.0</netmask> <gateway>10.20.0.1</gateway> </interface> <interface> <nicid>1</nicid> <type>virtual</type> <port_id>vnic1</port_id> <network>wan-net</network> <subnet>N/A</subnet> <mac_address>52:54:00:70:06:4a</mac_address> <netmask>255.255.255.0</netmask> <gateway>172.19.181.152</gateway> </interface> <interface> <nicid>2</nicid> <type>virtual</type> <port_id>vnic2</port_id> <network>lan-net</network> <subnet>N/A</subnet> <mac_address>52:54:00:c7:30:1c</mac_address> <netmask>255.255.255.0</netmask> <gateway>192.168.1.1</gateway> </interface> </interfaces> </vm_source> <event> <type>VM_UPDATED</type> </event> </pre>

Event Type	Notification Trigger	Notification Output Example
		<pre> </vmlcEvent></notification>]]>]]> <?xml version="1.0" encoding="UTF-8"?> <notification xmlns="urn:ietf:params:xml:ns:netconf:notification:1.0"> <eventTime>2017-12-08T00:50:39.06+00:00</eventTime> <vmlcEvent xmlns='http://www.cisco.com/nfvis/vm_lifecycle'> <status>SUCCESS</status> <status_code>200</status_code> <status_message>Service group update completed successfully</status_message> <user_name>admin</user_name> <depname>1512766000</depname> <tenant>admin</tenant> <tenant_id>adminUUID</tenant_id> <depid>92c11aa1-f6dd-47d1-948f-c8c65b9ef70f</depid> <event> <type>SERVICE_UPDATED</type> </event> </vmlcEvent> </pre>

Event Type	Notification Trigger	Notification Output Example
VM_UPDATED	VNIC is added, deleted or updated.	

Event Type	Notification Trigger	Notification Output Example
		<pre> <?xml version="1.0" encoding="UTF-8"?> <notification xmlns="urn:ietf:params:xml:ns:netconf:notification:1.0"> <eventTime>2017-12-08T02:10:56.184+00:00</eventTime> <vmlcEvent xmlns='http://www.cisco.com/nfvis/vm_lifecycle'> <status>SUCCESS</status> <status_code>200</status_code> <status_message>Added 1 interface: [managed, net=my-net-1, nicid=3] Updated 2 interface: [managed, net=lan-net, nicid=1],[managed, net=wan-net, nicid=2]</status_message> <user_name>admin</user_name> <depname>1512766000</depname> <tenant>admin</tenant> <tenant_id>adminUUID</tenant_id> <depid>92c11aa1-f6dd-47d1-948f-c8c65b9ef70f</depid> <vm_group>ROUTER</vm_group> <vm_source> <vmid>1a6f587e-2779-4087-b84d-c0a2c8a481b1</vmid> <vmname>1512766000_ROUTER_0_60d15064-0c6d-49b9-aa4a-80587f626004</vmname> <hostid>NFVIS</hostid> <hostname>nfvis</hostname> <interfaces> <interface> <nicid>0</nicid> <type>virtual</type> <port_id>vnic0</port_id> <network>int-mgmt-net</network> <subnet>N/A</subnet> <ip_address>10.20.0.3</ip_address> <mac_address>52:54:00:3c:ee:5b</mac_address> <netmask>255.255.255.0</netmask> <gateway>10.20.0.1</gateway> </interface> <interface> <nicid>1</nicid> <type>virtual</type> <port_id>vnic1</port_id> <network>lan-net</network> <subnet>N/A</subnet> <mac_address>52:54:00:70:06:4a</mac_address> <netmask>255.255.255.0</netmask> <gateway>192.168.1.1</gateway> </interface> <interface> <nicid>2</nicid> <type>virtual</type> <port_id>vnic2</port_id> <network>wan-net</network> <subnet>N/A</subnet> <mac_address>52:54:00:c7:30:1c</mac_address> <netmask>255.255.255.0</netmask> <gateway>172.19.181.152</gateway> </interface> <interface> <nicid>3</nicid> <type>virtual</type> <port_id>vnic3</port_id> </pre>

Event Type	Notification Trigger	Notification Output Example
		<pre><network>my-net-1</network> <subnet>N/A</subnet> <mac_address>52:54:00:66:b5:c1</mac_address> </interface> </interfaces> </vm_source> <event> <type>VM_UPDATED</type> </event> </vmlcEvent></pre>



CHAPTER 15

Syslog Support

Cisco enterprise NFVIS can send syslog messages to syslog servers configured by the user. Syslogs are sent for Network Configuration Protocol (NETCONF) notifications from NFVIS.

Syslog Message Format

Syslog messages have the following format:

```
<Timestamp> hostname %SYS-<Severity>-<Event>: <Message>
```

Sample Syslog messages:

```
2017 Jun 16 11:20:22 nfvis %SYS-6-AAA_TYPE_CREATE: AAA authentication type tacacs created successfully AAA authentication set to use tacacs server
2017 Jun 16 11:20:23 nfvis %SYS-6-RBAC_USER_CREATE: Created rbac user successfully: admin
2017 Jun 16 15:36:12 nfvis %SYS-6-CREATE_FLAVOR: Profile created: ISRV-small
2017 Jun 16 15:36:12 nfvis %SYS-6-CREATE_FLAVOR: Profile created: ISRV-medium
2017 Jun 16 15:36:13 nfvis %SYS-6-CREATE_IMAGE: Image created: ISRV_IMAGE_Test
2017 Jun 19 10:57:27 nfvis %SYS-6-NETWORK_CREATE: Network testnet created successfully
2017 Jun 21 13:55:57 nfvis %SYS-6-VM_ALIVE: VM is active: ROUTER
```

Configuring Syslog Servers

To configure a remote Syslog server:

```
configure terminal
system settings logging host 172.24.22.186
port 3500
transport tcp
commit
```



Note A maximum of 4 remote syslog servers can be configured. The remote syslog server can be specified using its IP address or DNS name. The default protocol for sending syslogs is UDP with a default port of 514. For TCP, the default port is 601.

To configure syslog severity:

```
configure terminal
system settings logging severity error
```



Note The severity levels are:

- debug
- informational
- alert
- notice
- warning
- error
- critical
- emergency

By default, the logging severity of syslogs is informational which means all syslogs at informational severity and higher will be logged.

To configure syslog facility:

```
configure terminal
system settings logging facility local5
```



Note The logging facility can be changed to a facility from local0 to local7

By default, NFVIS sends syslogs with the facility of local7

Syslog Support APIs and Commands

APIs	Commands
<ul style="list-style-type: none"> • /api/config/system/settings/logging • /api/operational/system/settings/logging 	<ul style="list-style-type: none"> • system settings logging host • system settings logging severity • system settings logging facility



CHAPTER 16

SNMP Support on NFVIS

- [Introduction about SNMP, on page 153](#)
- [SNMP Operations, on page 153](#)
- [SNMP Versions, on page 155](#)
- [SNMP MIB Support, on page 156](#)
- [Configuring SNMP Support, on page 158](#)

Introduction about SNMP

Simple Network Management Protocol (SNMP) is an application-layer protocol that provides a message format for communication between SNMP managers and agents. SNMP provides a standardized framework and a common language used for the monitoring and management of devices in a network.

The SNMP framework has three parts:

- **SNMP manager** - The SNMP manager is used to control and monitor the activities of network hosts using SNMP.
- **SNMP agent** - The SNMP agent is the software component within the managed device that maintains the data for the device and reports these data, as needed, to managing systems.
- **MIB** - The Management Information Base (MIB) is a virtual information storage area for network management information, which consists of collections of managed objects.

A manager can send the agent requests to get and set MIB values. The agent can respond to these requests. Independent of this interaction, the agent can send unsolicited notifications (traps or informs) to the manager to notify the manager of network conditions.

SNMP Operations

SNMP applications perform the following operations to retrieve data, modify SNMP object variables, and send notifications:

- **SNMP Get** - The SNMP GET operation is performed by a Network Management Server (NMS) to retrieve SNMP object variables.
- **SNMP Set** - The SNMP SET operation is performed by a Network Management Server (NMS) to modify the value of an object variable.

- SNMP Notifications - A key feature of SNMP is its capability to generate unsolicited notifications from an SNMP agent.

SNMP Get

The SNMP GET operation is performed by a Network Management Server (NMS) to retrieve SNMP object variables. There are three types of GET operations:

- GET: Retrieves the exact object instance from the SNMP agent.
- GETNEXT: Retrieves the next object variable, which is a lexicographical successor to the specified variable.
- GETBULK: Retrieves a large amount of object variable data, without the need for repeated GETNEXT operations.

The command for SNMP GET is :

```
snmpget -v2c -c [community-name] [NFVIS-box-ip] [tag-name, example ifSpeed].[index value]
```

SNMP Walk

SNMP walk is an SNMP application that uses SNMP GETNEXT requests to query a network entity for a tree of information.

An object identifier (OID) may be given on the command line. This OID specifies which portion of the object identifier space will be searched using GETNEXT requests. All variables in the subtree below the given OID are queried and their values presented to the user.

The command for SNMP walk with SNMP v2 is:

```
snmpwalk -v2c -c [community-name] [nfvis-box-ip]
```

```
snmpwalk -v2c -c myUser 172.19.147.115 1.3.6.1.2.1.1
SNMPv2-MIB::sysDescr.0 = STRING: Cisco NFVIS
SNMPv2-MIB::sysObjectID.0 = OID: SNMPv2-SMI::enterprises.9.12.3.1.3.1291
DISMAN-EVENT-MIB::sysUpTimeInstance = Timeticks: (43545580) 5 days, 0:57:35.80
SNMPv2-MIB::sysContact.0 = STRING:
SNMPv2-MIB::sysName.0 = STRING:
SNMPv2-MIB::sysLocation.0 = STRING:
SNMPv2-MIB::sysServices.0 = INTEGER: 70
SNMPv2-MIB::sysORLastChange.0 = Timeticks: (0) 0:00:00.00
IF-MIB::ifIndex.1 = INTEGER: 1
IF-MIB::ifIndex.2 = INTEGER: 2
IF-MIB::ifIndex.3 = INTEGER: 3
IF-MIB::ifIndex.4 = INTEGER: 4
IF-MIB::ifIndex.5 = INTEGER: 5
IF-MIB::ifIndex.6 = INTEGER: 6
IF-MIB::ifIndex.7 = INTEGER: 7
IF-MIB::ifIndex.8 = INTEGER: 8
IF-MIB::ifIndex.9 = INTEGER: 9
IF-MIB::ifIndex.10 = INTEGER: 10
IF-MIB::ifIndex.11 = INTEGER: 11
IF-MIB::ifDescr.1 = STRING: GE0-0
IF-MIB::ifDescr.2 = STRING: GE0-1
IF-MIB::ifDescr.3 = STRING: MGMT
IF-MIB::ifDescr.4 = STRING: gigabitEthernet1/0
IF-MIB::ifDescr.5 = STRING: gigabitEthernet1/1
IF-MIB::ifDescr.6 = STRING: gigabitEthernet1/2
```

```

IF-MIB::ifDescr.7 = STRING: gigabitEthernet1/3
IF-MIB::ifDescr.8 = STRING: gigabitEthernet1/4
IF-MIB::ifDescr.9 = STRING: gigabitEthernet1/5
IF-MIB::ifDescr.10 = STRING: gigabitEthernet1/6
IF-MIB::ifDescr.11 = STRING: gigabitEthernet1/7
...
SNMPv2-SMI::mib-2.47.1.1.1.1.2.0 = STRING: "Cisco NFVIS"
SNMPv2-SMI::mib-2.47.1.1.1.1.3.0 = OID: SNMPv2-SMI::enterprises.9.1.1836
SNMPv2-SMI::mib-2.47.1.1.1.1.4.0 = INTEGER: 0
SNMPv2-SMI::mib-2.47.1.1.1.1.5.0 = INTEGER: 3
SNMPv2-SMI::mib-2.47.1.1.1.1.6.0 = INTEGER: -1
SNMPv2-SMI::mib-2.47.1.1.1.1.7.0 = STRING: "ENC5412/K9"
SNMPv2-SMI::mib-2.47.1.1.1.1.8.0 = STRING: "M3"
SNMPv2-SMI::mib-2.47.1.1.1.1.9.0 = ""
SNMPv2-SMI::mib-2.47.1.1.1.1.10.0 = STRING: "3.7.0-817"
SNMPv2-SMI::mib-2.47.1.1.1.1.11.0 = STRING: "FGL203012P2"
SNMPv2-SMI::mib-2.47.1.1.1.1.12.0 = STRING: "Cisco Systems, Inc."
SNMPv2-SMI::mib-2.47.1.1.1.1.13.0 = ""
...

```

The following is a sample configuration of SNMP walk with SNMP v3:

```

snmpwalk -v 3 -u user3 -a sha -A changePassphrase -x aes -X changePassphrase -l authPriv
-n snmp 172.16.1.101 system
SNMPv2-MIB::sysDescr.0 = STRING: Cisco ENC5 5412, 12-core Intel, 8 GB, 8-port PoE LAN, 2
HDD, Network Compute System
SNMPv2-MIB::sysObjectID.0 = OID: SNMPv2-SMI::enterprises.9.1.2377
DISMAN-EVENT-MIB::sysUpTimeInstance = Timeticks: (16944068) 1 day, 23:04:00.68
SNMPv2-MIB::sysContact.0 = STRING:
SNMPv2-MIB::sysName.0 = STRING:
SNMPv2-MIB::sysLocation.0 = STRING:
SNMPv2-MIB::sysServices.0 = INTEGER: 70
SNMPv2-MIB::sysORLastChange.0 = Timeticks: (0) 0:00:00.00

```

SNMP Notifications

A key feature of SNMP is the ability to generate notifications from an SNMP agent. These notifications do not require that requests be sent from the SNMP manager. Unsolicited (asynchronous) notifications can be generated as traps or inform requests. Traps are messages alerting the SNMP manager to a condition on the network. Inform requests (informs) are traps that include a request for confirmation of receipt from the SNMP manager. Notifications can indicate improper user authentication, restarts, the closing of a connection, loss of connection to a neighbor router, or other significant events.



Note Starting from Release 3.8.1 NFVIS has SNMP Trap support for switch interfaces. If a trap server is setup in the NFVIS snmp configuration, it will send trap messages for both NFVIS and switch interfaces. Both the interfaces are triggered by the link state up or down by unplugging a cable or setting admin_state up or down when a cable is connected.

SNMP Versions

Cisco enterprise NFVIS supports the following versions of SNMP:

- SNMP v1—The Simple Network Management Protocol: A Full Internet Standard, defined in RFC 1157. (RFC 1157 replaces the earlier versions that were published as RFC 1067 and RFC 1098.) Security is based on community strings.
- SNMP v2c—The community-string based Administrative Framework for SNMPv2. SNMPv2c (the "c" stands for "community") is an Experimental Internet Protocol defined in RFC 1901, RFC 1905, and RFC 1906. SNMPv2c is an update of the protocol operations and data types of SNMPv2p (SNMPv2 Classic), and uses the community-based security model of SNMPv1.
- SNMPv3—Version 3 of SNMP. SNMPv3 is an interoperable standards-based protocol defined in RFCs 3413 to 3415. SNMPv3 provides secure access to devices by authenticating and encrypting packets over the network.

The security features provided in SNMPv3 are as follows:

- Message integrity—Ensuring that a packet has not been tampered with in transit.
- Authentication—Determining that the message is from a valid source.
- Encryption—Scrambling the contents of a packet to prevent it from being learned by an unauthorized source.

Both SNMP v1 and SNMP v2c use a community-based form of security. The community of managers able to access the agent MIB is defined by an IP address Access Control List and password.

SNMPv3 is a security model in which an authentication strategy is set up for a user and the group in which the user resides. A security level is the permitted level of security within a security model. A combination of a security model and a security level determines which security mechanism is employed when handling an SNMP packet.

Authentication of the community with the user configuration is implemented even though SNMP v1 and v2 traditionally do not require a user configuration to be set. For both SNMP v1 and v2 on NFVIS, the user must be set with the same name and version as the corresponding community name. The user group must also match an existing group with the same SNMP version for snmpwalk commands to work.

SNMP MIB Support

The following MIB's are supported for SNMP on NFVIS:

IF-MIB:

- ifDescr
- ifType
- ifPhysAddress
- ifSpeed
- ifOperStatus
- ifAdminStatus
- ifMtu
- ifName

- ifHighSpeed
- ifPromiscuousMode
- ifConnectorPresent
- ifInErrors
- ifInDiscards
- ifInOctets
- ifOutErrors
- ifOutDiscards
- ifOutOctets
- ifOutUcastPkts
- ifHCInOctets
- ifHCInUcastPkts
- ifHCOctets
- ifHCOctets
- ifHCOctets
- ifHCOctets
- ifInBroadcastPkts
- ifOutBroadcastPkts
- ifInMulticastPkts
- ifOutMulticastPkts
- ifHCInBroadcastPkts
- ifHCOctets
- ifHCInMulticastPkts
- ifHCOctets

Entity MIB:

- entPhysicalIndex
- entPhysicalDescr
- entPhysicalVendorType
- entPhysicalContainedIn
- entPhysicalClass
- entPhysicalParentRelPos
- entPhysicalName
- entPhysicalHardwareRev
- entPhysicalFirmwareRev

- entPhysicalSoftwareRev
- entPhysicalSerialNum
- entPhysicalMfgName
- entPhysicalModelName
- entPhysicalAlias
- entPhysicalAssetID
- entPhysicalIsFRU

Cisco Process MIB:

- cpmCPUTotal5secRev
- cpmCPUTotal1minRev
- cpmCPUTotal5minRev
- cpmCPUTotalIndex
- cpmCPUTotalPhysicalIndex
- cpmCPUMonInterval
- cpmCPUMemoryKernelReserved
- cpmCPUMemoryHCKernelReserved
- cpmCPUMemoryUsed
- cpmCPUMemoryFree
- cpmCPUMemoryHCUsed
- cpmCPUMemoryHCFree
- CISCO_ENVMON_MIB
- cpmProcessDynamicMemorySizeOvrflw
- cpmProcessType
- cpmCPULoadAvg1min
- cpmCPULoadAvg5min
- cpmCPULoadAvg15min

Configuring SNMP Support

Though SNMP v1 and v2c is using community-based string, the following is still required:

- Same community and user name.
- Same SNMP version for user and group.

To configure SNMP v2 support:

```
configure terminal
snmp community public community-access readOnly

snmp group testgroup snmp 2 noAuthNoPriv read read-access write write-access notify
notify-access

snmp user public user-group testgroup user-version 2

snmp host host2 host-ip-address 2.2.2.2 host-port 162 host-user-name public host-version 2
host-security-level noAuthNoPriv

snmp enable traps linkUp
```

To configure SNMP v3 support:

```
configure terminal
snmp group testgroup3 snmp 3 authPriv notify test write test read test
snmp user user3 user-version 3 user-group testgroup3 auth-protocol sha priv-protocol aes
passphrase changePassphrase
! configure snmp host to enable snmp v3 trap
snmp host host3 host-ip-address 3.3.3.3 host-version 3 host-user-name user3
host-security-level authPriv host-port 162
!
! Change to different security level
!
snmp group testgroup4 snmp 3 authNoPriv notify test write test read test
snmp user user4 user-version 3 user-group testgroup4 auth-protocol md5 passphrase
changePassphrase
! configure snmp host to enable snmp v3 trap
snmp host host4 host-ip-address 4.4.4.4 host-version 3 host-user-name user4
host-security-level authNoPriv host-port 162
!
!
snmp enable traps linkUp
snmp enable traps linkDown
```



Note SNMP host configuration is supported for NFVIS 3.6.1 release. Host trap server configuration will be officially supported for NFVIS 3.7.1 release.



Note SNMP v3 context **snmp** is added automatically when configured from the web portal. To use a different context value or empty context string, use NFVIS CLI or API for configuration.

NFVIS SNMP v3 only supports single passphrase for both auth-protocol and priv-protocol.



Note NFVIS 3.11.1 release enhances the special character support for passphrase. Now the following characters are supported: @#\$-!&*



Note NFVIS 3.12.1 release supports the following special characters: `-_#@%$*&!` and whitespace. Backslash (`\`) is not supported.

Verify the configuration for SNMP support

Use the `show snmp agent` command to verify the snmp agent description and ID.

```
nfvis# show snmp agent

snmp agent sysDescr "Cisco NFVIS "
snmp agent sysOID 1.3.6.1.4.1.9.12.3.1.3.1291
```

Use the `show snmp traps` command to verify the state of snmp traps.

```
nfvis# show snmp traps

TRAP      TRAP
NAME      STATE
-----
linkDown  disabled
linkUp    enabled
```

Use the `show snmp stats` command to verify the snmp stats.

```
nfvis# show snmp stats

snmp stats sysUpTime      57351917
snmp stats sysServices    70
snmp stats sysORLastChange 0
snmp stats snmpInPkts     104
snmp stats snmpInBadVersions 0
snmp stats snmpInBadCommunityNames 0
snmp stats snmpInBadCommunityUses 0
snmp stats snmpInASNParseErrs 0
snmp stats snmpSilentDrops 0
snmp stats snmpProxyDrops 0
```

Use the `show running-config snmp` command to verify the interface configuration for snmp.

```
nfvis# show running-config snmp

snmp agent enabled true
snmp agent engineID 00:00:00:09:11:22:33:44:55:66:77:88
snmp enable traps linkUp
snmp community pub_comm
community-access readOnly
!
snmp community tachen
community-access readOnly
!
snmp group tachen snmp 2 noAuthNoPriv
read test
write test
notify test
```

```

!
snmp group testgroup snmp 2 noAuthNoPriv
read read-access
write write-access
notify notify-access
!
snmp user public
user-version 2
user-group 2
auth-protocol md5
priv-protocol des
!
snmp user tachen
user-version 2
user-group tachen
!
snmp host host2
host-port 162
host-ip-address 2.2.2.2
host-version 2
host-security-level noAuthNoPriv
host-user-name public
!

```

Upper limit for SNMP configurations:

- Communities: 10
- Groups: 10
- Users: 10
- Hosts: 4

SNMP Support APIs and Commands

APIs	Commands
<ul style="list-style-type: none"> • /api/config/snmp/agent • /api/config/snmp/communities • /api/config/snmp/enable/traps • /api/config/snmp/hosts • /api/config/snmp/user • /api/config/snmp/groups 	<ul style="list-style-type: none"> • agent • community • trap-type • host • user • group



CHAPTER 17

TACACS and RADIUS Support on NFVIS

- [About RADIUS, on page 163](#)
- [RADIUS Operation, on page 163](#)
- [Configuring a TACACS+ Server, on page 164](#)
- [Configuring RADIUS, on page 165](#)
- [Specifying TACACS and RADIUS Authentication, on page 166](#)

About RADIUS

Remote Authentication Dial-In User Service (RADIUS) is a distributed client-server system that secures networks against unauthorized access. In the Cisco implementation, RADIUS clients run on Cisco routers and send authentication requests to a central RADIUS server that contains all user authentication and network service access information.

RADIUS is a fully open protocol, distributed in source code format, that can be modified to work with any security system currently available on the market.

Cisco supports RADIUS under its AAA security paradigm. RADIUS has been implemented in a variety of network environments that require high levels of security while maintaining network access for remote users.

RADIUS Operation

When a user attempts to log in and authenticate to an access server using RADIUS, the following steps occur:

1. The user is prompted to enter the username and password.
2. The username and encrypted password are sent over the network to the RADIUS server.
3. The user receives one of the following responses from the RADIUS server:
 - a. ACCEPT—The user is authenticated.
 - b. CHALLENGE—A challenge is issued by the RADIUS server. The challenge collects additional data from the user.
 - c. CHANGE PASSWORD—A request is issued by the RADIUS server, asking the user to select a new password.

- d. REJECT—The user is not authenticated and is prompted to reenter the username and password, or access is denied.

The ACCEPT or REJECT response is bundled with additional data that is used for EXEC or network authorization. You must first complete RADIUS authentication before using RADIUS authorization. The additional data included with the ACCEPT or REJECT packets consists of the following:

- Services that the user can access, including connections such as Telnet, rlogin, or local-area transport (LAT), and services such as PPP, Serial Line Protocol (SLIP), or EXEC services.
- Connection parameters, including the host or client IP address, access list, and user timeouts.

Configuring a TACACS+ Server

TACACS+ is a security application that provides centralized validation of users attempting to gain access to a router or network access server. TACACS+ services are maintained in a database on a TACACS+ daemon running, typically, on a UNIX or Windows NT workstation. You must configure a TACACS+ server before the configured TACACS+ features on your network access server are available.

On the TACACS+ server, ensure you configure Cisco attribute-value (AV) pair privilege level (priv-lvl) for Cisco Enterprise NFVIS service for the minimum privilege level of administrators and operators.

For more details on TACACS+ configuration, see the Configuring TACACS module in [TACACS+ Configuration Guide](#), Cisco IOS XE Release 3S.



Note In NFVIS 3.11.1 or earlier release, users with no privilege level or users with a privilege level that is less than the operator's privilege level are considered as auditors with read-only permission.

After NFVIS 3.12.1 release, users with privilege level zero won't be able to login to NFVIS anymore.

To configure TACACS+:

```
configure terminal
tacacs-server host 209.165.201.20 shared-secret test1
key 0
admin-priv 14
oper-priv 9
commit
```

In this configuration, privilege level 14 is assigned to the administrator role, and privilege level 9 is assigned to the operator role. This means a user with privilege level 14 or higher will have all admin privileges when the user logs into the system, and a user with privilege level 9 or higher will have all privileges of an operator at the time of login.

Starting from NFVIS 3.9.2 release, TACACS+ secret encryption is supported. You can only configure either secret key or encrypted secret key at a given time. Encrypted secret key can contain special characters but secret key cannot. For NFVIS 3.12.1 release, the following pattern is supported for encrypted-shared-key: `[-_a-zA-Z0-9-.\<>%!*$€#{}()]+`.

To configure encrypted TACACS+ key:

```
configure terminal
```

```
tacacs-server host 209.165.201.20 encrypted-shared-secret test1
key 0
admin-priv 14
oper-priv 9
commit
```

Verifying the TACACS+ configuration

Use the **show running-config tacacs-server** command to verify the configuration if encrypted TACACS+ key is configured:

```
nfvis# show running-config tacacs-server

tacacs-server host 209.165.201.20
 encrypted-shared-secret $8$mRTnL9TKZCFi1BUP7Mwbm3JVio4Z7QvJ
 admin-priv                15
 oper-priv                 11
!
```

TACACS+ APIs and Commands

TACACS+ APIs	TACACS+ Commands
<ul style="list-style-type: none"> • /api/config/security_servers/tacacs-server • /api/config/security_servers/tacacs-server?deep • /api/config/security_servers/tacacs-server /host/<ip-address/domain-name> 	<ul style="list-style-type: none"> • tacacs-server host • key • admin-priv • oper-priv

Configuring RADIUS

To configure RADIUS support:

```
radius-server host 103.1.4.3
key 0
shared-secret cisco123
admin-priv 2
oper-priv 1
commit
```

Starting from NFVIS 3.9.2 release, TACACS+ secret encryption is supported. You can only configure either secret key or encrypted secret key at a given time. To configure encrypted RADIUS key:

```
radius-server host 103.1.4.3
key 0
encrypted-shared-secret cisco123
admin-priv 2
oper-priv 1
commit
```

Verifying the RADIUS configuration

Use the `show running-config radius-server` command to verify the interface configuration for a RADIUS session:

```

nfvis# show running-config radius-server

radius-server host 103.1.4.3
key          0
shared-secret cisco123
admin-priv   2
oper-priv    1

```

RADIUS Support APIs and Commands

APIs	Commands
• /api/config/security_servers/radius-server	• host

Specifying TACACS and RADIUS Authentication

NFVIS supports both TACACS+ and RADIUS but only one authentication method can be enable at a time. After you have identified the TACACS+ and RADIUS server and defined an associated TACACS+ and RADIUS authentication key, you must define method lists for TACACS+ and RADIUS authentication. Because TACACS+ and RADIUS authentication is operated through AAA, you need to issue the `aaa` authentication command, specifying TACACS+ or RADIUS as the authentication method.

```

nfvis(config)# aaa authentication ?
Possible completions:
radius      Use RADIUS for AAA
tacacs      Use TACACS+ for AAA
users       List of local users

```

**Note**

- Only when TACACS+ or RADIUS is enabled, it can be used for authentication.
- When TACACS+ or RADIUS is not accessible, local authentication is used. Local authentication is disabled if the connection between TACACS+ or RADIUS and NFVIS is restored.
- If same username exists on both local and TACACS+ or RADIUS, then TACACS+ or RADIUS user is chosen for authentication.
- It is recommended to configure [Syslog Support, on page 151](#) so that it is easier to debug if TACACS+ or RADIUS does not work as expected.

All login attempts will be logged in syslogs in the local `/var/log/nfvis_syslog.log` file and in remote syslog servers. It is important to configure a remote syslog server when configuring TACACS+/RADIUS in order to be able to view logs regarding login attempts when TACACS+/RADIUS is configured.



CHAPTER 18

ENCS Switch Configuration

Access to the ENCS switch is restricted through Consent Token. Consent Token is a security feature that is used to authenticate the network administrator of an organization to access system shell with mutual consent from the network administrator and Cisco Technical Assistance Centre (Cisco TAC).



Note From the switch console, there is access to debug mode and an advanced debug mode. Credentials of the local user are synchronized to access debug mode. Advanced debug uses unique credentials for each device that allows for additional debugging options for Cisco engineering. To enter either debug mode permission must be granted through Consent Token.

- [ENCS Switch Commands, on page 167](#)
- [ENCS Switch APIs, on page 167](#)
- [ENCS Switch Portal Configuration, on page 167](#)

ENCS Switch Commands

See, [Cisco Enterprise Network Compute System Switch Command Reference](#) for switch commands.

ENCS Switch APIs

See, [API Reference for Cisco Enterprise Network Function Virtualization Infrastructure Software](#) for switch related APIs.

ENCS Switch Portal Configuration

Switch Settings

The **Switch** option from the Cisco Enterprise NFVIS portal allows you to configure STP/RSTP, VLAN on specified ranges, RADIUS based authentication, and port channel load balancing for various switch ports. This section describes how to configure settings on the ENCS switch portal.

SwitchPort ^	Description ⇅	Status ⇅	MAC Address ⇅	PortType
GigabitEthernet1/0		down	00:a6:ca:d6:32:d9	access
GigabitEthernet1/1		down	00:a6:ca:d6:32:da	access
GigabitEthernet1/2		down	00:a6:ca:d6:32:db	access
GigabitEthernet1/3		down	00:a6:ca:d6:32:dc	access
GigabitEthernet1/4		down	00:a6:ca:d6:32:dd	access
GigabitEthernet1/5		down	00:a6:ca:d6:32:de	access
GigabitEthernet1/6		down	00:a6:ca:d6:32:df	access
GigabitEthernet1/7		down	00:a6:ca:d6:32:e0	access

You can view the Switch Interface operational data and the statistics parameters in the following table:

Table 5: Switch Settings Interface

Parameter	Description	Values
SwitchPort	Specifies the switch interface name.	
Description	Specifies the description of the interface.	
Status	Specifies the status of the interface.	up or down
MAC Address	Specifies the MAC address of the interface.	
PortType	Specifies the mode of the port interface.	Supported types are: <ul style="list-style-type: none"> • access • dot1q-tunnel • private-vlan • trunk
VLAN	Specifies the VLAN ID.	Range: 1-2349 and 2450-4093

Speed	Specifies the speed of the interface.	Speed: <ul style="list-style-type: none"> • 10 MBPS • 100 MBPS • 1000 MBPS
RxBytes	Specifies the received data on interface in bytes.	
PktDrop	Specifies the number of packet drops.	
PORT	Specifies the port number.	
IN-UCAST	Specifies the number of incoming unicast packets at the interface.	
OUT-UCAST	Specifies the number of outgoing unicast packets at the interface.	
IN-MCAST	Specifies the number of incoming multicast packets at the interface.	
OUT-MCAST	Specifies the number of outgoing multicast packets at the interface.	
IN-BCAST	Specifies the number of incoming broadcast packets at the interface.	
OUT-BCAST	Specifies the number of outgoing broadcast packets at the interface.	

Configuring Spanning Tree

Spanning Tree Protocol (STP) is a Layer 2 protocol that runs on bridges and switches. The main purpose of STP is to ensure that you do not create loops when you have redundant paths in your network.

The Spanning Tree option is enabled by default. You can click on **edit** and make the necessary settings or disable Spanning Tree if required.

Spanning Tree

dot1x

Spanning Tree
 Enable Disable

LACP

Mode
 ▼

Vlan

Forward Time

Hello Time

Max Age

Loopback Guard
 Enable Disable

Path Cost Method
 ▼

Priority

The configuration of spanning tree has the following parameters when it is enabled:

Table 6: Spanning Tree Parameters

Parameter	Description	Values
Spanning Tree	Specifies the state of the Spanning Tree.	Enable or Disable The default value is Enable.
Mode	Specifies the mode of the Spanning Tree.	stp or rstp
Forward Time	Specifies the Spanning Tree forward time in seconds.	Range: 4-30 seconds
Hello Time	Specifies the Hello time in seconds.	Range: 1 to10 seconds

Max Age	Specifies the spanning-tree bridge maximum age in seconds.	Range: 6 to 40 seconds
Loopback Guard	Specifies the loopback guard status.	Enable or Disable
Path Cost Method	Specifies the speed of the interface.	Method: <ul style="list-style-type: none"> • long - for 32 bit based values for default port path costs. • short - 16 bit based values for default port path costs. The default method is long.
Priority	Specifies the port priority.	Range: 0 to 61440 in steps of 4096 The default value is 32768.
BPDU Filtering	Specifies that BPDU packets are filtered when the spanning tree is disabled on an interface.	
BPDU Flooding	Specifies that BPDU packets are flooded unconditionally when the spanning tree is disabled on an interface.	

Configuring Dot1x

This chapter describes how to configure dot1x port-based authentication on the Cisco Enterprise NFVIS portal. dot1x prevents unauthorized devices (clients) from gaining access to the network. It is a standard for media-level (Layer 2) access control, offering the capability to permit or deny network connectivity based on the identity of the end user or device. The dot1x is disabled by default. You can click on **edit** to enable dot1x.

366825

The configuration of dot1x has the following parameters:

Table 7: Dot1x Parameters

Parameter	Description	Values
Authentication	Specifies the authentication type for the port.	radius or none The default value is radius.
Guest VLAN Timeout(s)	Specifies the time delay in seconds between enabling Dot1X (or port up) and adding the port to the guest VLAN.	Range: 30 to 180 seconds
System Auth control	Specifies the authentication control.	Enable or Disable

Configuring LACP

The Link Aggregation Control Protocol (LACP) enables you to bundle several physical ports together to form a single logical channel. LACP enables you to form a single Layer 2 link automatically from two or more Ethernet links. This protocol ensures that both ends of the Ethernet link are functional and are part of the aggregation group.

The screenshot shows the LACP configuration page. On the left, there is a navigation menu with 'Spanning Tree', 'dot1x', 'LACP', and 'Vlan'. The main content area displays 'System Priority' with a value of 1 and 'Port-channel Load balance' set to 'Mac Based'. There is an 'Edit' button at the bottom right of the configuration area.

LACP uses the following parameters to control aggregation:

Table 8. LACP Parameters

Parameter	Description	Values
System Priority	Specifies the port priority.	Range: 1 to 65535
Port-channel load balance	Specifies the load balance of the port channel.	Mac Based or IP Based

Configuring VLAN

You can use virtual LANs (VLANs) to divide the network into separate logical areas. VLANs can also be considered as broadcast domains. Any switch port can belong to a VLAN, and unicast, broadcast, and multicast packets are forwarded and flooded only to end stations in that VLAN. Each VLAN is considered a logical network, and packets destined for stations that do not belong to the VLAN must be forwarded through a router.

You can configure VLANs in the range <1-2349>|<2450-4093> for a specified switch port.

The screenshot shows the VLAN configuration page. On the left, there is a navigation menu with 'Spanning Tree', 'dot1x', 'LACP', and 'Vlan'. The main content area displays 'VLAN' configuration with a value of 1. There is an 'Edit' button at the bottom right of the configuration area.

Configuring General Settings

General Settings
Advanced Settings

Interface GigabitEthernet1/0

Description

Speed 1000 ▼

Dot1x Auth 802.1x ▼

Admin Status ◌

✔ Apply
✘ Cancel

You can configure general settings using the following parameters for each switch interface:

- Interface—Name of the interface
- Description—Set the description per interface
- Speed—10/100/1000 MBPS
- Dot1x Auth—802.1x, mac or both
- PoE Method—auto, never or four-pair
- PoE Limit—0-60000mW
- Admin Status—enable or disable

Configuring Advanced Settings

The screenshot shows the 'Configuring Advanced Settings' interface for a switch interface. The interface is divided into two tabs: 'General Settings' and 'Advanced Settings'. The 'Advanced Settings' tab is active, showing the following configuration options:

- Mode:** access (dropdown menu)
- Access Vlan:** 1 (text input)
- Allowed Vlan:** All Vlan IDs (radio buttons), with a text input field containing '1-2349,2450-4093'.
- Native Vlan:** 1 (text input)
- dot1q Tunnel Vlan:** (empty text input)
- Community:** 1-29 (text input)
- Protected Port:** Yes No (radio buttons)

At the bottom right, there are two buttons: 'Apply' (with a checkmark icon) and 'Cancel' (with an 'X' icon).

You can make the advanced settings using the following parameters for each switch interface:

- Mode—access, dot1q-tunnel, private-vlan, or trunk
- Access Vlan—Specifies the number of VLANs.
- Allowed Vlan—All or VLAN IDs
- Native Vlan—Specifies the VLAN ID. You can enter a value from one of the following ranges:
 - 1 to 2349
 - 2450 to 4093
- Dot1q Tunnel Vlan—Specifies the Layer 2 tunnel port.

- Community—Specifies the community number. Range: 1 to 29
- Protected Port—Yes or No



Note The VLAN configuration takes effect only if the global VLANs are also configured with the same values in [Configuring VLAN, on page 173](#).

Configuring Spanning Tree per Interface

General Settings
Advanced Settings

Spanning Tree Enable Disable

Cost

Priority

Link Type

BPDU Guard Enable Disable

Root Guard Enable Disable

Port Fast

You can configure spanning tree for each switch interface using the following parameters:

- Spanning Tree—Enable or Disable
- Cost—Specifies the cost. Range: 1 to 200000000
- Priority—Specifies the port priority. Range: 0 to 240, default value is 128
- Link Type—point-to-point or shared
- BPDU Guard—Enable or Disable
- Root Guard—Enable or Disable
- Port Fast—auto or enable
- BPDU Filtering—Specifies that BPDU packets are filtered when the spanning tree is disabled
- BPDU Flooding—Specifies that BPDU packets are flooded when the spanning tree is disabled



CHAPTER 19

Configuring Secondary IP and Source Interface

Secondary IP

The Cisco Enterprise NFVIS supports multiple IP addresses per interface. A Secondary IP feature can be configured on the WAN interface, as an additional IP to reach the software. Set the external routes for Secondary IP to reach the NFVIS. Routers configured with secondary addresses can route between the different subnets attached to the same physical interface.

To access secondary IP through ISRv, the WAN physical port is removed from wan-br similar to single IP.

To configure Secondary IP:

Configure Secondary IP

```
nfvis(config)# system settings wan secondary ip address 1.1.2.3 255.255.255.0
```

Source Interface

This feature is used to set the source interface for packets with source IP address, generated by NFVIS using the default route.

Prerequisites for configuring Source Interface

- IP must be one of the configured IP addresses in system settings.
- The source-interface IP address can be one of the following:
 - mgmt
 - WAN
 - WAN Secondary IP
 - WAN2 IP or IP configured on any bridge
- Source-interface configuration must be applied if the WAN IP is static.
- For DHCP, Source-interface IP is accepted but cannot be applied. The configuration takes effect once you switch from DHCP to static.

To configure Source Interface:

```
Configure source-interface ip
nfvis(config)# system settings source-interface 1.1.2.3
```

The Secondary IP and Source Interface related errors are logged in **show log /var/log/nfvis_config.log** file.

Secondary IP and Source Interface APIs and Commands

APIs	Commands
<ul style="list-style-type: none"> • /api/config/system/settings/wan/secondary 	<ul style="list-style-type: none"> • system settings wan secondary
<ul style="list-style-type: none"> • /api/config/system/settings/source-interface 	<ul style="list-style-type: none"> • system settings source-interface



CHAPTER 20

Ports and Port Channels

This chapter contains the following sections.

- [Configuring Port Channels, on page 181](#)
- [Configuring LLDP, on page 184](#)
- [Configuring Admin Status of a Port, on page 184](#)
- [Tracking Changes for a Port, on page 185](#)
- [Speed, Duplex and Autonegotiation, on page 185](#)

Configuring Port Channels

Information About Port Channels

Port channels provide a mechanism for combining individual links into a group to create a single logical link that provides the aggregate bandwidth of up to eight physical links. Port channels provide increased bandwidth and redundancy and balance the traffic load between the members port. If a member port within a port channel fails, traffic previously carried over the failed port switches to the remaining member ports.

Port channels can be configured using static mode (no protocol) or the Link Access Control Protocol (LACP). Any configuration changes that you apply to the port channel are applied to each member port of the port channel. A port channel must have at least two ports. A port channel can be added to a bridge. A bond is created when a port channel has more than two members and the port channel is added to a bridge.

A port can be a member of only one port channel. All the ports in a port channel must be compatible; they must use the same speed and operate in full-duplex mode.

Port Channels Bond Mode

A port channel can be configured for the following bond modes:

- **active-backup**: In this mode, one of the ports in the aggregated link is active and all others ports are in the standby mode.
- **balance-slb**: In this mode, load balancing of traffic is done based on the source MAC address and VLAN.
- **balance-tcp**: In this mode, 5-tuple (source and destination IP, source and destination port, protocol) is used to balance traffic across the ports in an aggregated link.

Port Channels LACP Mode

A port channel can be configured for the following LACP modes:

- **off**: Indicates that no mode is applicable.
- **active**: Indicates that the port initiates transmission of LACP packets.
- **passive**: Indicates that the port only responds to the LACP packets that it receives but does not initiate the LACP negotiation.

Creating a Port Channel

To create a port channel:

```
configure terminal
pnac pc type port_channel lacp_type active bond_mode balance-tcp trunks 10, 20
commit
```

Port Channel Creation APIs and Commands

APIs	Commands
/api/config/pnics	pnac <i>name</i> type port_channel
/api/operational/pnics	show pnac

Adding a Port to a Port Channel

A port channel must have at least two ports. A bond is created when a port channel has more than two members and the port channel is added to a bridge. You can add a port to a new port channel or a port channel that already contains ports.

To add a port to a port channel:

```
configure terminal
pnac eth1 member_of pc
commit
```

Adding a Port to a Port Channel APIs and Commands

APIs	Commands
/api/config/pnics/pnac/ <i>name</i> /member_of	pnac <i>name</i> member_of <i>portchannel_name</i>

Adding a Port Channel to a Bridge

You can add a port channel to a new bridge or an existing bridge. When a port channel is added to a bridge, a bond is added for the port channel.

To add a port channel to a bridge:

```
configure terminal
bridges bridge test-br port pc
commit
```

Adding a Port Channel to a Bridge APIs and Commands

APIs	Commands
/api/config/bridges/bridge/ <i>bridgename</i>	bridges bridge <i>name</i> port <i>portchannel_name</i>

Deleting a Port Channel

Before deleting a port channel, you must remove all members assigned to the port channel. If the port channel is configured on the bridge, you must remove the port channel from the bridge.

To delete a port channel:

```
configure terminal
no pnic pc
commit
```

Port Channel Deletion APIs and Commands

APIs	Commands
/api/config/pnics/pnic/ <i>portchannel_name</i>	no pnic <i>portchannel_name</i>
/api/operational/pnics	show pnic

Removing a Port from a Port Channel

To remove a port from a port channel:

```
configure terminal
no pnic eth1 member_of pc
commit
```

Removing a Port from a Port Channel APIs and Commands

APIs	Commands
/api/config/pnics/pnic/ <i>name</i> /member_of	no pnic <i>name</i> member_of <i>portchannel_name</i>

Removing a Port Channel from a Bridge

To remove a port channel from a bridge:

```
configure terminal
no bridges bridge test-br port pc
commit
```

Removing a Port Channel from a Bridge APIs and Commands

APIs	Commands
/api/config/bridges/bridge/ <i>bridgename</i>	no bridges bridge <i>bridgename</i> port <i>portname</i>

Configuring LLDP

To enable LLDP on a port:

```
configure terminal
pnic eth0 lldp enabled
commit
```

To disable LLDP on a port:

```
configure terminal
pnic eth0 lldp disabled
commit
```

LLDP Configuration APIs and Commands

APIs	Commands
/api/config/pnics/pnic/ <i>portname</i> /lldp	pnic <i>name</i> lldp
/api/operational/lldp	show lldp
/api/operational/lldp?deep	

Configuring Admin Status of a Port

To bring a port up administratively:

```
configure terminal
pnic eth5 adminstatus up
commit
```

To bring a port down administratively:

```
configure terminal
pnic eth5 adminstatus down
commit
```

Admin Status Configuration APIs and Commands

APIs	Commands
/api/config/pnics/pnic/ <i>portname</i> /adminstatus	pnic <i>name</i> adminstatus

Tracking Changes for a Port



Note This feature is supported only on ENCS 5400.

The configured VNICs tracks the state of the ports based on the PNICs notifications. To verify the state of the port, use **show interface** or **ethtool** commands. You can also use commands specific to the VM, that displays the interface link state.

To configure track state on GE0-0 & GE0-1:

```
configure terminal
pnic GE0-0 track-state ROUTER 1
end
```

To configure track state on switch port:

```
configure terminal
switch interface gigabitEthernet 1/0 track-state ROUTER 2
end
```

Speed, Duplex and Autonegotiation

To enable autonegotiation on a port:

```
configure terminal
pnic GE0-0 speed auto duplex auto
commit
```

To configure speed and duplex with non auto values:

```
configure terminal
pnic GE0-0 speed 100 duplex full
commit
```

Speed can be set to 10, 100, 1G, 10G, 10G_PF, 10G_SR, 10G_VF and auto. Duplex values can be set at full, half and auto.

Use **show pnic GE0-0 operational-speed**, **show pnic GE0-0 operational-duplex** and **show pnic GE0-0 autoneg** to verify the configurations.



Note The speed and duplex configurations are dependent on the peer configuration. If the peer is set at a certain speed and duplex, NFVIS port is set to match that speed. Not all ports on ENCS 5000 series hardware devices support Automatic medium-dependent interface crossover (auto-MDIX) feature. Based on the port connected to the ENCS device, the cable type used to connect to the peer and the speed or duplex settings on the peer, you can try straight through and cross over cable.



CHAPTER 21

MSTP for ENCS 5400 8-Port Switch

Multiple Spanning Trees Protocol (MSTP) is introduced to the 8-port switch on ENCS 5400. MSTP enables multiple VLANs to be mapped to the same spanning tree instance, which reduces the number of spanning-tree instances needed to support a large number of VLANs.

ENCS 5400 switch supports 15 instances. Each spanning tree instance is identified by an instance ID from 1 to 15.

To enable MST:

```
configure terminal
switch
    spanning-tree mode mst
    commit
```

To configure VLAN-to-instance mapping:

```
configure terminal
switch
    spanning-tree mst configuration
        instance 1 vlan 15
        name mst_test
        revision 2
    commit
```

To configure the switch priority:

```
configure terminal
switch
    spanning-tree mst 1 priority 0
    commit
```

To configure the path cost per interface's mst instance:

```
configure terminal
switch
    interface gigabitEthernet 1/1
        spanning-tree mst 1 port-priority 96
        spanning-tree mst 1 cost 2
    commit
```

To configure the maximum hop count for all MST instances:

```
configure terminal
```

```
switch
  spanning-tree mst max-hops 10
  commit
```

Use the **show switch spanning-tree mstp configuration global** command to verify the MSTP configuration.

```
nfvis# show switch spanning-tree mstp configuration global
spanning-tree mstp configuration global name transit-net
spanning-tree mstp configuration global revision 2
spanning-tree mstp configuration global max-hops 20
```

Use the **show switch spanning-tree mstp configuration instance-list** command to verify the MSTP instance configuration.

```
nfvis# show switch spanning-tree mstp configuration instance-list
INSTANCE  VLANS MAPPED      STATE
-----
0          1,2350-2353,2363  enabled
1          15                enabled
```

To display the global information for MSTP instance 2 use **show switch spanning-tree mstp summary instance-global-info** command.

To display interface information for MSTP instance 2 use **show switch spanning-tree mstp summary instance-interface-info 2** command