



Wide-Area Networking Configuration Guide: Multilink PPP, Cisco IOS XE Everest 16.6

Americas Headquarters

Cisco Systems, Inc.
170 West Tasman Drive
San Jose, CA 95134-1706
USA
<http://www.cisco.com>
Tel: 408 526-4000
800 553-NETS (6387)
Fax: 408 527-0883

THE SPECIFICATIONS AND INFORMATION REGARDING THE PRODUCTS IN THIS MANUAL ARE SUBJECT TO CHANGE WITHOUT NOTICE. ALL STATEMENTS, INFORMATION, AND RECOMMENDATIONS IN THIS MANUAL ARE BELIEVED TO BE ACCURATE BUT ARE PRESENTED WITHOUT WARRANTY OF ANY KIND, EXPRESS OR IMPLIED. USERS MUST TAKE FULL RESPONSIBILITY FOR THEIR APPLICATION OF ANY PRODUCTS.

THE SOFTWARE LICENSE AND LIMITED WARRANTY FOR THE ACCOMPANYING PRODUCT ARE SET FORTH IN THE INFORMATION PACKET THAT SHIPPED WITH THE PRODUCT AND ARE INCORPORATED HEREIN BY THIS REFERENCE. IF YOU ARE UNABLE TO LOCATE THE SOFTWARE LICENSE OR LIMITED WARRANTY, CONTACT YOUR CISCO REPRESENTATIVE FOR A COPY.

The Cisco implementation of TCP header compression is an adaptation of a program developed by the University of California, Berkeley (UCB) as part of UCB's public domain version of the UNIX operating system. All rights reserved. Copyright © 1981, Regents of the University of California.

NOTWITHSTANDING ANY OTHER WARRANTY HEREIN, ALL DOCUMENT FILES AND SOFTWARE OF THESE SUPPLIERS ARE PROVIDED "AS IS" WITH ALL FAULTS. CISCO AND THE ABOVE-NAMED SUPPLIERS DISCLAIM ALL WARRANTIES, EXPRESSED OR IMPLIED, INCLUDING, WITHOUT LIMITATION, THOSE OF MERCHANTABILITY, FITNESS FOR A PARTICULAR PURPOSE AND NON-INFRINGEMENT OR ARISING FROM A COURSE OF DEALING, USAGE, OR TRADE PRACTICE.

IN NO EVENT SHALL CISCO OR ITS SUPPLIERS BE LIABLE FOR ANY INDIRECT, SPECIAL, CONSEQUENTIAL, OR INCIDENTAL DAMAGES, INCLUDING, WITHOUT LIMITATION, LOST PROFITS OR LOSS OR DAMAGE TO DATA ARISING OUT OF THE USE OR INABILITY TO USE THIS MANUAL, EVEN IF CISCO OR ITS SUPPLIERS HAVE BEEN ADVISED OF THE POSSIBILITY OF SUCH DAMAGES.

Any Internet Protocol (IP) addresses and phone numbers used in this document are not intended to be actual addresses and phone numbers. Any examples, command display output, network topology diagrams, and other figures included in the document are shown for illustrative purposes only. Any use of actual IP addresses or phone numbers in illustrative content is unintentional and coincidental.

Cisco and the Cisco logo are trademarks or registered trademarks of Cisco and/or its affiliates in the U.S. and other countries. To view a list of Cisco trademarks, go to this URL: <https://www.cisco.com/go/trademarks>. Third-party trademarks mentioned are the property of their respective owners. The use of the word partner does not imply a partnership relationship between Cisco and any other company. (1721R)

© 2018 Cisco Systems, Inc. All rights reserved.



CONTENTS

CHAPTER 1

Read Me First 1

CHAPTER 2

Multilink PPP Support 3

- Cisco IOS XE Scaling Limits for MLP Bundles 4
 - Restrictions for MLP over Serial Interfaces 5
 - Restrictions for MLP over Ethernet at PTA and LAC 6
 - Restrictions for MLP over ATM at PTA and LAC 6
 - Restrictions for MLP at LAC 7
 - Restrictions for MLP over LNS 7
 - Restrictions for Broadband MLP at PTA and LNS 8
- Information About Multilink PPP Support 8
 - Quality of Service 9
 - Multilink PPP Packet Overhead Accounting for Shaping and Policing 10
 - Downstream Model-F Shaper on LNS 11
 - Bandwidth 11
 - MTU 12
 - Downstream LFI 12
 - MLP Fragmentation Model 14
 - IP Type of Service Reflect 14
 - IP Tunnel Marking 15
 - Unsupported Features 15
- Additional References for Multilink PPP Support 16
- Feature Information for Multilink PPP Support 17

CHAPTER 3

Configuring Multilink PPP Connections for Broadband and Serial Topologies 19

- Finding Feature Information 19
- Restrictions for Multilink PPP Connections for Broadband and Serial Topologies 20
- Information About Multilink PPP Connections for Broadband and Serial Topologies 21

Multilink PPP	21
Multilink PPP Bundles	21
Multilink PPP Bundles and PPP Links	21
Link Fragmentation and Interleaving	23
Types of Multilink PPP Bundle Interfaces	23
Multilink Group Interface	23
Virtual Access Interface	23
Factors that Govern a Link Joining a Bundle	24
Rate of Session Establishment for Multilink PPP Bundles	25
Multilink PPP Packet Overhead	26
Multilink PPP over Serial Interfaces	26
Multilink PPP over Broadband	27
PTA Mode	28
LNS Mode	28
Performance- and Scalability-Related Commands	29
Multilink PPP over ATM on the PTA Device	30
Multilink PPP over Ethernet over ATM on the PTA Device	30
Multilink PPP over LNS	30
Switching Multilink PPP Traffic Through a LAC Device	31
QoS Traffic and Shaping	32
How to Configure Multilink PPP Connections for Broadband and Serial Topologies	32
Configuring Multilink PPP	32
Creating a Multilink Bundle	32
Assigning an Interface to a Multilink Bundle	34
Configuring Minimum Multilink PPP Links	35
Changing the Default Endpoint Discriminator	36
Configuring Multilink PPP Interleaving and Queuing	37
Configuring Multilink PPP Interleaving	38
Disabling PPP Multilink Fragmentation	39
Configuring Multilink PPP over Broadband	40
Creating a Class Map	40
Creating a Policy Map	41
Defining a PPP over Ethernet Profile	42
Configuring a Virtual Template Interface	43
Configuring Multilink PPP over ATM on the CPE Device	45

Configuring Multilink PPP over ATM Using AAL5 MUX Encapsulation	45
Configuring Multilink PPP over ATM Using AAL5 SNAP Encapsulation	47
Configuring Multilink PPP over Ethernet over ATM at the CPE	48
Configuring Multilink PPP over ATM on the PTA Device	49
Configuring Multilink PPP over ATM Using AAL5 MUX Encapsulation	50
Configuring Multilink PPP over ATM Using AAL5 SNAP Encapsulation	51
Configuring Multilink PPP over Ethernet over ATM on the PTA Device	52
Configuring a Virtual Circuit Class	52
Configuring Multilink PPP over Ethernet over ATM Using AAL5 SNAP Encapsulation	54
Configuring Multilink PPP over LNS	55
Configuring an LNS Device to Initiate and Receive L2TP Traffic	55
Configuring a LAC Device to Initiate and Receive L2TP Traffic	58
Configuring Multilink PPP over Serial Interfaces	59
Configuration Examples for Multilink PPP Connections for Broadband and Serial Topologies	61
Example: Configuring Multilink PPP	61
Example: Configuring Multilink PPP over ATM on the PTA Device	63
Example: Configuring Multilink PPP over ATM Using AAL5 MUX Encapsulation	63
Example: Configuring Multilink PPP over ATM Using AAL5 SNAP Encapsulation	63
Example: Configuring Multilink PPP over Ethernet over ATM on the PTA Device	64
Example: Configuring Multilink PPP over LNS	65
Example: Configuring an LNS Device to Initiate and Receive L2TP Traffic	65
Example: Configuring a LAC Device to Initiate and Receive L2TP Traffic	66
Example: Configuring Multilink PPP over Serial Interfaces	67
Additional References for Multilink PPP Connections for Broadband and Serial Topologies	69
Feature Information for Multilink PPP Connections for Broadband and Serial Topologies	70

CHAPTER 4**MLPoE at PTA 73**

Finding Feature Information	73
Prerequisites for MLPoE at PTA	73
Restrictions for MLPoE at PTA	74
Information About MLPoE at PTA	74
MLPoE at PTA Overview	74
How to Configure MLPoE at PTA	75
Configuring MLPoE at PTA	75

Configuring MLPoE over VLAN	76
Configuring MLPoE over QinQ	77
Configuration Examples for MLPoE at PTA	78
Example: Configuring MLPoE at PTA	78
Example: Configuring MLPoE over VLAN	79
Example: Configuring MLPoE over QinQ	80
Additional References for MLPoE at PTA	80
Feature Information for MLPoE at PTA	81

CHAPTER 5

Configurable CHAP Challenge Length	83
Prerequisites for Configurable CHAP Challenge Length	83
Information About Configurable CHAP Challenge Length	83
Configurable CHAP Challenge Length Overview	83
How to Configure Configurable CHAP Challenge Length	84
Configuring Configurable CHAP Challenge Length	84
Configuration Examples for Configurable CHAP Challenge Length	85
Example: Configuring Configurable CHAP Challenge Length	85
Additional References for Configurable CHAP Challenge Length	85
Feature Information for Configurable CHAP Challenge Length	86



Read Me First

Important Information about Cisco IOS XE 16

Effective Cisco IOS XE Release 3.7.0E (for Catalyst Switching) and Cisco IOS XE Release 3.17S (for Access and Edge Routing) the two releases evolve (merge) into a single version of converged release—the Cisco IOS XE 16—providing one release covering the extensive range of access and edge products in the Switching and Routing portfolio.

Feature Information

Use [Cisco Feature Navigator](#) to find information about feature support, platform support, and Cisco software image support. An account on Cisco.com is not required.

Related References

- [Cisco IOS Command References, All Releases](#)

Obtaining Documentation and Submitting a Service Request

For information on obtaining documentation, using the Cisco Bug Search Tool (BST), submitting a service request, and gathering additional information, see [What's New in Cisco Product Documentation](#).

To receive new and revised Cisco technical content directly to your desktop, you can subscribe to the [What's New in Cisco Product Documentation RSS feed](#). RSS feeds are a free service.



CHAPTER 2

Multilink PPP Support

First Published: October 2012

Last Updated: August 23, 2016

Multilink Point-to-Point Protocol (MLP) provides support to aggregate the bandwidth of low-speed WAN and broadband links into a single entity, referred to as a bundle interface. A bundle interface is a logical entity that provides a single point in which other features (for example, Quality of Service [QoS]) can be attached. MLP provides incremental bandwidth on demand, by adding additional links to the bundle, as needed. MLP also enables interleaving of latency-sensitive priority traffic with fragmented nonpriority traffic using link fragmentation and interleaving (LFI).

Member links that are a part of an MLP bundle can be bundled across ports on:

- The same shared port adapter (SPA)
- Different SPAs on the same SPA interface processor (SIP)
- Different SPAs on different SIPs

The Cisco IOS XE software supports MLP links for serial (T1, E1, NxDS0) and broadband topologies such as Multilink PPP over ATM (MLPoA), Multilink PPP over Ethernet (MLPoE), Multilink PPP over Ethernet over ATM (MLPoEoA), and Multilink PPP over LNS (MLPoLNS). Additionally, the Cisco IOS XE software allows the device to operate as an L2TP Access Concentrator (LAC), L2TP Network Server (LNS), or PPP Termination and Aggregation (PTA) device.

This document describes the features, limitations, and scaling of MLP on the Cisco ASR 1000 Series Aggregation Services Routers running the Cisco IOS XE software. For information about the configuration and operation of MLP in the Cisco IOS XE software, see the “Configuring Multilink PPP Connections” chapter in the [Wide-Area Networking Configuration Guide: Multilink PPP, Cisco IOS XE Release 3S \(Cisco ASR 1000\)](#).

- [Cisco IOS XE Scaling Limits for MLP Bundles](#), page 4
- [Information About Multilink PPP Support](#), page 8
- [Additional References for Multilink PPP Support](#), page 16
- [Feature Information for Multilink PPP Support](#), page 17

Cisco IOS XE Scaling Limits for MLP Bundles

This section lists the scaling limits for MLP bundles in different releases of Cisco IOS XE, in which scaling limits were either introduced or enhanced.

Release 2.2.(0)S

In Cisco IOS XE Release 2.2.(0)S, the MLP feature was introduced on the Cisco ASR 1000 Series Aggregation Services Routers. MLPoSerial was the first supported transport. In this release, MLP bundles can consist of up to 10 serial links. The bandwidth of each link interface does not have to be the same as the other links in the bundle. The Cisco ASR 1000 Series Aggregation Services Routers support links of types T1, E1, and NxDS0. MLP LFI is fully supported with MLPoSerial in this release.

Release 3.4.(0)S

In Cisco IOS XE Release 3.4.(0)S, the MLP feature was enhanced to enable the Cisco ASR 1000 Series Aggregation Services Routers to act as LAC, LNS, or PTA devices. Support for tunneling bundles between the LAC device and the LNS device was added. In this release, transport between the LAC device and the LNS device is Layer 2 Tunnel Protocol (L2TP). The L2TP tunnels can operate on either 1-Gbps or 10-Gbps interfaces. When ASR 1000 Series Aggregation Services Router acts as an LNS device, it terminates the MLP bundles coming through the L2TP tunnel from the LAC. In this release, support was added for MLP upstream fragment reassembly, but not for MLP downstream fragmentation.

Release 3.7.1S

In Cisco IOS XE Release 3.7.1S, the existing support for the MLP feature in a broadband topology was enhanced. The scaling limits were increased for the Ethernet transports, and downstream fragmentation support was added for the broadband topologies.

In this release, when a Cisco ASR 1000 Series Aggregation Services Router acts as an LNS device, it terminates the MLP bundles coming through the L2TP tunnel from the LAC. The scaling targets mentioned for MLP over broadband are based on RP2/ESP40 and 2RU-VE hardware configurations. The scaling capabilities are less for RP1 and ESP5, ESP10, or ESP20.

The implementation of MLP on a Cisco ASR 1000 Series Aggregation Services Router does not support all the Cisco IOS XE interoperability features.

Release 3.12.(0)S

In Cisco IOS XE Release 3.12.(0)S, the multi-member-link MLPoA or MLPoEoA, including Downstream, is introduced. The scaling limits are increased for the member links in MLPoA or MLPoEoA scenarios.

[Table 1: MLP Features and Maximum Scale Numbers, on page 4](#) shows the maximum scale numbers for various MLP functionalities on the Cisco ASR 1000 Series Aggregation Services Routers.

Table 1: MLP Features and Maximum Scale Numbers

Transport	Maximum Number of Members per Bundle	Maximum Number of Bundles per System	Maximum Number of Member Links per System	Downstream LFI	Upstream Fragment Reassembly	Cisco IOS XE Release
MLPoSerial	10	1232	1232	Yes	Yes	2.2.0S

Transport	Maximum Number of Members per Bundle	Maximum Number of Bundles per System	Maximum Number of Member Links per System	Downstream LFI	Upstream Fragment Reassembly	Cisco IOS XE Release
MLPoA AAL5MUX	1	1000	1000	No	Yes	3.4.0S
MLPoA AAL5MUX	8	4000	4000	Yes	Yes	3.12.0S
MLPoA AAL5SNAP	1	1000	1000	No	Yes	3.4.0S
MLPoA AAL5SNAP	8	4000	4000	Yes	Yes	3.12.0S
MLPoE	1	4000	4000	No	Yes	3.4.0S
MLPoE	8	4000	4000	Yes	Yes	3.7.1S
MLPoEoA AAL5SNAP	1	1000	1000	No	Yes	3.4.0S
MLPoEoA AAL5SNAP	8	4000	4000	Yes	Yes	3.12.0S
MLPoEoQinQ	1	4000	4000	No	Yes	3.4.0S
MLPoEoQinQ	8	4000	4000	Yes	Yes	3.7.1S
MLPoEoVLAN	1	4000	4000	No	Yes	3.4.0S
MLPoEoVLAN	8	4000	4000	Yes	Yes	3.7.1S
MLPoLNS	1	4000	4000	No	Yes	3.4.0S
MLPoLNS	8	4000	4000	Yes	Yes	3.7.1S

Restrictions for MLP over Serial Interfaces

The following restrictions apply to MLP over Serial Interfaces:

- The MLP over Serial Interfaces feature supports a maximum of ten member links per bundle. The member links can be any combination of T1/E1 or fractional T1s/E1s (for example, NxDS0). Member-link interface speed above T1/E1 is not supported in the MLP over Serial Interfaces feature. For better MLP performance, all the member links in a bundle must be of the same bandwidth.
- Member links in a bundle cannot be of different encapsulation types.

- You cannot manually configure the bandwidth of an MLP bundle by using the bandwidth command on the multilink interface. The bandwidth of an MLP bundle is managed based on the aggregate bandwidth of all the active member links on the bundle. As the links are dynamically added or removed from an MLP bundle, the bandwidth is updated to reflect the aggregate of the active links. The bandwidth can be rate limited by applying an hierarchical QoS policy on the multilink interface and applying a shaper to the parent class-default class.
- MLP over Frame Relay is not supported; only MLP over Serial PPP link is supported. Customers who require multilink support in a frame relay environment can use the Multilink Frame Relay (MLFR-FRF.16) feature.
- The legacy IOS compression feature compress [mppc | stac | predictor] is not supported.
- LFI is supported on MLP bundles with any number of links in the bundle. However, when using a bundle with more than one member link, the order of the priority packets (PPP encapsulated) is not guaranteed. Priority-packet distribution is handled in a manner similar to IP per-packet load sharing. MLP guarantees nonpriority packet ordering that manages reordering at the peer device, based on the MLP packet sequence number.
- Order issues with the LFI multiple-member link in case of priority traffic can be addressed in some platforms using Multiclass Multilink Protocol (MCMP-RFC 2686), which is an extension of the MLP. The Cisco ASR 1000 Series Aggregation Services Routers do not support MCMP.
- Only the MLP long-sequence number format is supported for the packet header format option.

Restrictions for MLP over Ethernet at PTA and LAC

The following restrictions apply to MLP over Ethernet at PTA and LAC:

- MLPoE using EtherChannel is not supported.
- For MLP virtual access bundles, the default Layer 3 (that is IP and IPv6) maximum transmission unit (MTU) value is 1500. For more information about MTU, see the **MTU** section.
- For MLPoE PTA variations (MLPoE, MLPoVLAN, and MLPoQinQ), the default bandwidth of the member-link session is 1 Gbps instead of the data rate communicated by the DSLAM to the PTA router. If a bandwidth statement is added to the virtual template, the bandwidth is applied to the bundle instead of the member link. This is not the desired behavior. (To define the data rate of an MLPoE PTA-type bundle, apply a QoS policy on the bundle session that includes a parent shaper on the class-default class with an explicit data rate defined. Do not use the shape percent command in this parent shaper because the shape percent command uses the default data rate of 1 Gbps as the base rate for percent calculation. However, the percent-based rates can be defined in the child (nested) policy, if an hierarchical policy is being defined.
- If the DSLAM between the CPE and PTA communicates the link rate through the PPPoE dsl-sync-rate tags (Actual Data-Rate Downstream [0x82/130d] tag), the PTA device passes this data to the RADIUS server, but the Cisco ASR 1000 Series Aggregation Services Routers do not act upon it. The data rate of the session remains as described in the previous list item.

Restrictions for MLP over ATM at PTA and LAC

The following restrictions apply to MLP over ATM at PTA and LAC:

- ATM Autosense is supported to allow the dynamic selection of MLPoA or MLPoEoA.
- For ATM, the link-level bandwidth is a part of the ATM Permanent Virtual Circuits (PVC) configuration based on the unspecified bit rate (UBR) or variable bit rate (VBR) configurations. The bundle bandwidth is the aggregate of the member-link session bandwidth.

**Note**

The MLP over Ethernet over ATM at PTA and LAC has the same restrictions as the MLP over ATM at PTA and LAC.

Restrictions for MLP at LAC

In case of MLP over LNS (Ethernet) LAC switching, the MLP member-link session and the packet payload is transparent at the LAC device because it does not terminate the MLP session or the bundle interface. Hence, the LAC device does not bind the number of member-link sessions associated with a bundle. Similarly, the LFI functionality is transparent at the LAC device because the traffic is switched or passed through traffic.

Restrictions for MLP over LNS

The following restrictions apply to MLP over LNS:

- MLPoLNS bundles are supported with only Ethernet as the trunk between the LAC and LNS.
- Layer 2 Tunnel Protocol (L2TP) over IPsec is not supported.
- QoS (other than downstream Model-F shaping) on interfaces and tunnels towards the customer premise equipment (CPE) is not supported.
- When the CPE client initiates the PPP LCP connection, the multilink negotiation included as part of the LCP negotiation may fail if the LAC has not yet established connection with the LNS (which is typically the case). The LNS renegotiates the Multilink LCP options with the CPE client when the LAC initiates the connection to the LNS. (To allow this renegotiation of LCP options, the **lcp renegotiation always** command must be configured in the VPDN group at the LNS).
- Although per-packet load balancing is not supported, the configuration is not blocked and the functionality is operational (but not tested). Per-packet load balancing cannot be used with MLPoLNS because MLPoLNS requires a single-path per-destination IP address.
- Unlike the MLP over Serial mode or the MLP PTA mode, packets may traverse several network hops between the CPE and LNS devices in an MLPoLNS network. As a result of this multihop topology, even on a single-link bundle, MLP encapsulated packets may arrive at the receiver in an out-of-order state. Hence, the MLPoLNS receiver operates in a loose, lost-fragment detection mode. In this mode, if an MLP fragment is lost, the received MLP waits for a short time to receive the lost fragment. In addition, the MLP receiver limits the amount of out-of-order MLP data received before the fragment is declared lost. In Cisco IOS XE software, the default timeout value is 1 second. This may create problems in an environment with high packet loss and scaled MLP configurations because it requires the receiver to potentially buffer large amounts of data for each MLP bundle. Since the buffer space that is available is a finite resource, worst-case depletion of buffers can bleed over and begin affecting packet buffering on other MLP bundles. (The MLP lost-fragment timeout can be configured on the multilink virtual template interface using the **ppp timeout multilink lost-fragment** (*seconds*) (*milliseconds*) configuration command).

By default, in MLPoLNS, the Cisco IOS XE software informs the MLP that packets may arrive out of order. This works well for upstream traffic, but does not address the order issue at the peer CPE device. The peer CPE device should also be configured to allow for receipt of out-of-order packets. In Cisco devices, this can be managed by configuring the **ppp link reorders** command at the bundle interface.

- When the Cisco ASR 1000 Series Aggregation Services Routers function as both a PTA device and an LNS device simultaneously, locally terminated member links (PTA) and member links that are forwarded from the LAC are not supported within the same bundle.

Restrictions for Broadband MLP at PTA and LNS

The following restrictions apply to all variations of broadband MLP at PTA and LNS modes:

- When defining an MLP bundle with multiple member-link sessions, we recommend that all the member-link sessions utilize the same physical interface or subinterface. If other broadband sessions are sharing the same interface, ensure that all the member-link sessions utilize the same physical interface or subinterface.
- The following issues might occur because of splitting links across separate physical interfaces or subinterfaces:
 - MLP is a sequenced protocol and all the packets and fragments must be reordered and reassembled at the receiver, based on the MLP sequence number before the receiver forwards them. In such a scenario, packets traversing separate physical interfaces may cause additional packet latency disparity between links due to transmission delays and other issues associated with using multiple physical paths. The reordering and reassembly processing may require additional MLP buffering at the receiver.
 - MLP on the Cisco ASR 1000 Series Aggregation Services Routers performs congestion management of the MLP bundle based on the congestion state of the member-link sessions that make up the bundle. If member-links are distributed across multiple interfaces and sufficient congestion is detected in one or more member links, the bundle may be back pressured due to the congestion even if all the links in the bundle are not congested. By keeping all the links on the same physical interface or subinterface, the chance of back pressure due to one link being congested is reduced.

Information About Multilink PPP Support

The Multilink PPP feature provides the load-balancing functionality over multiple WAN links, while providing multivendor interoperability, packet fragmentation, proper sequencing, and load calculation for both inbound and outbound traffic. Cisco implementation of MLP supports the fragmentation and packet-sequencing specifications described in RFC 1990.

Some Cisco IOS platforms use the **interface multilink** command for both MLP over Serial and MLP over ATM (MLPoA) to configure multilink bundle interfaces. On the Cisco ASR 1000 Series Aggregation Services Routers, multilink bundle interfaces are configured using the **interface multilink** command for MLP over Serial and the **interface Virtual-Template** command for MLPoA.

On the Cisco ASR 1000 Series Aggregation Services Routers, all broadband MLP configurations use the **interface Virtual-Template** command to define the multilink bundle configuration. A virtual access interface is created dynamically from the virtual template when the session is negotiated with the peer device.

Quality of Service

QoS refers to the ability of a network to provide improved service to selected network traffic over various underlying technologies, including Frame Relay, ATM, Ethernet and 802.1 networks, SONET, and IP-routed networks. In particular, QoS features provide improved and more predictable network service.

For serial deployments, QoS is applied to an MLP bundle using the **multilink** configuration command. For broadband deployments, QoS is applied to an MLP bundle using the **virtual-template** command. When a router dynamically creates the virtual access interface from the virtual template, the QoS policy is applied to the corresponding bundle.

QoS is characterized by the following features and restrictions:

- To rate limit a broadband MLP bundle session, use a hierarchical QoS (HQoS) policy with a parent shaper in the class-default class.
- The Cisco ASR 1000 Series Aggregation Services Routers support HQoS queuing only in the egress (output) direction, and not in the ingress direction.
- The Cisco IOS XE software supports Model-F QoS with MLP. Model-F QoS on the L2TP tunnel is not supported on the Cisco ASR 1002-X Router and the FP100 line card.
 - In Cisco IOS XE Release 3.7.1S, support was added for Model-F QoS on the L2TP tunnel when the device acts as an LNS. A parent shaper policy can be applied to the physical subinterface that connects the LNS to the LAC device. This enables the shaping of the aggregate traffic going downstream to the LAC device.
 - If a Model-F shaper is attached to the LAC-facing interface after the sessions are established through that interface, the sessions must be bounced to handle the priority traffic appropriately.
- In Cisco IOS XE Release 3.4S, the **shape average shape-rate account user-defined offset atm** command supports only the broadband MLP interface and not the MLP over serial interface. The range for the **offset** argument is from -48 to 48 bytes. In Cisco IOS XE Release 3.6S, the **shape average shape-rate account user-defined offset atm** command supports MLP over serial interface.
- ATM cell loss priority (CLP) Match (classification) and Set (marking) are not supported with broadband MLP.
- When packets transit the MLP transmit path, they are subject to two separate stages of queuing. The first stage is at the MLP bundle interface, where QoS may be applied, and the second one is at the MLP member-link interface. At the MLP bundle interface, the packets are processed according to the applied QoS policy. Packets classified as priority are given preferential treatment over nonpriority traffic. For the priority classification to be honored at the MLP member-link interface, the bundle must have `ppp multilink interleave` enabled. Interleaving allows a packet to be queued to a separate priority queue at the member-link. If interleaving is not enabled on the bundle, the priority packet is placed in the member link session default queue and the knowledge that it is a priority packet will be lost. This is especially important if there are other PPP or MLP sessions sharing the same physical interface or subinterface. Without interleaving, priority traffic on the other sessions are given preferential treatment over the MLP priority packets that were reclassified as nonpriority packets at the MLP member-link queuing stage. For additional information on interleaving, see the *Downstream LFI* section.

Multilink PPP Packet Overhead Accounting for Shaping and Policing

On the Cisco ASR 1000 Series Aggregation Services Routers, Multilink PPP adjusts the packet length presented for shaping and policing to include the additional Layer 2 overhead added by Multilink PPP. For MLP over Serial, overhead accounting includes the MLP and PPP Layer 2 overhead. For Broadband MLPs such as MLPoE, MLPoEoVLAN, MLPoEoQinQ, MLPoEoA, MLPoA, and MLPoLNS, overhead accounting includes the MLP, PPP, Ethernet, ATM, and L2TP (LNS) Layer 2 overhead. If the output interface is ATM, such as the MLPoA or MLPoEoA, the Cisco ASR 1000 Series Aggregation Services Routers also take into account the ATM Cell overhead for the shaper. The ATM Cell overhead is not accounted for policing.

Shaping and policing overhead accounting does not include the additional overheads added by a SPA such as, Ethernet CRC, preamble, IPG, serial interface CRC, start of packet (SOP) delimiter, end of packet (EOP) delimiter, and serial-bit stuffing (the only exception being the ATM Cell overhead for the shaper referred to earlier). The overhead added by a SPA can be included in the shaper using the QoS **shape accounting user-defined** option.

If you do not define a QoS shaper for the multilink bundle interface, a default shaper is applied to the bundle based on the aggregate bandwidth of all the links that make up the multilink bundle. The information contained in this section applies to both the default shaper and a QoS user-defined shaper, which the user may explicitly configure and apply to a multilink bundle.

The priority packets that are interleaved are sent PPP encapsulated and the MLP Layer 2 overhead is not included because MLP encapsulation is not included in these packets. During overhead accounting for link fragmentation, overhead accounting calculations are performed prior to the actual link fragmentation and link selection for Multilink PPP load balancing.

If all the member links in the corresponding multilink bundle use the same fragment size, the number of fragments are calculated and the overhead is adjusted to include the additional per-fragmentation Layer 2 header overhead for the shaper and policer. If one or more links in the bundle use different fragment sizes, the number of fragments cannot be calculated with 100 percent accuracy because link selection for load balancing and fragment size is not known until QoS processing is completed at the bundle level (after shaping and policing). For links with unequal fragment size, a best effort attempt is made using the largest link fragment size on the bundle. By using the largest fragment size, MLP avoids undersubscribing the member-link interfaces. If the links become oversubscribed, MLP will backpressure the bundle to avoid sustained oversubscription of the member links.

In Cisco IOS XE Release 3.4S on the Cisco ASR 1000 Series Aggregation Services Routers, support for shaping and policing overhead accounting was added for Broadband Multilink PPP. In addition, support was added for the Shape User-Defined Overhead Accounting feature using the following QoS command:

```
shape [average | peak] mean-rate [burst-size] [excess-burst-size] account {{{qinq | dot1q} {aal5 | aal3} {subscriber-encapsulation}} | {user-defined offset [atm]}}
```

This command enables you to include the additional overhead added by a SPA using the **user-defined** option. For example, the Ethernet SPA adds an additional 24 bytes per packet so that a user-defined value of 24 covers Ethernet IPG (12) + Preamble (8) + CRC32 (4). Another interesting scenario is when deploying MLPoLNS in an ATM topology. The physical link between the LNS and the LAC is Ethernet, and the physical link between the LAC and the CPE is ATM. In such a scenario, you can add the **atm** keyword to include the ATM Cell overhead between the LAC and the CPE.

In Cisco IOS XE Release 3.6S, shaping and policing overhead accounting support was added for Serial Multilink PPP and Multilink PPP LFI.

For more information on shaping and policing, see the IOS XE Ethernet Overhead Accounting documentation at: http://www.cisco.com/en/US/docs/ios-xml/ios/qos_plcshp/configuration/xs-3s/qos-plcshp-ether-ohead-actg.html

Downstream Model-F Shaper on LNS

From Cisco IOS XE Release 3.7.1S, Model-F downstream shaping support for MLPoLNS is available to the Cisco ASR 1000 Series Aggregation Services Routers when these routers function as an LNS device.



Note

Model-F downstream shaping for MLPoLNS is not supported on the Cisco ASR 1002-X Router and the FP100 line card.

This section provides an example of a Model-F policy with a parent shaper policy attached to a VLAN interface on the LNS device. The VLAN interface is used for the L2TP tunnel between the LAC device and the LNS device. The following configuration example shows an aggregate shaper applied to a VLAN, which shapes all the MLP sessions going downstream to the LAC device:

```
policy-map lns_downstream_shaper_out
class class-default
shape average 5000000
interface GigabitEthernet0/1/0.2
encapsulation dot1Q 2
ip address 90.0.0.1 255.255.255.0
service-policy output lns_downstream_shaper_out
```



Note

Model-F QoS allows a parent shaper on the class-default class by using a flat policy. No additional QoS functionalities are supported in the Model-F policy.

Bandwidth

The interface-level **bandwidth** command must not be used to define the bandwidth at the bundle level on the virtual template interface or the multilink interface. By default, the bundle bandwidth is the aggregate of the bandwidth of the individual member links that make up the bundle.

For ATM, the link-level bandwidth is part of the ATM Permanent Virtual Circuits (PVC) configuration based on the unspecified bit rate (UBR) or variable bit rate (VBR) configurations. The member-link bandwidth cannot be set for an MLPoE session on a PTA device. To define the bandwidth for an MLPoE-type bundle on a PTA device, a QoS policy must be applied to the bundle interface that shapes the bundle bandwidth at the class-default class with a parent shaper.

In PPPoE and MLPoE broadband networks, the DSL access multiplexer (DSLAM) placed between the customer premises equipment (CPE) and LAC or PTA, inserts a PPPoE vendor tag. This tag includes information such as, media rate, characteristics, and identification pertaining to the circuit or session.

For more information about Ethernet-based networks, see DSL Forum TR-101 Migration to Ethernet-Based DSL Aggregation April 2006 at:

<http://www.broadband-forum.org/technical/download/TR-101.pdf>

<http://www.broadband-forum.org/technical/download/TR-101.pdf>

The PTA passes media-rate information to the RADIUS server for selecting an appropriate QoS policy to the bundle session based on the reported bandwidth. In the context of MLP over LNS, the LAC passes media-rate information to both the RADIUS server and the LNS router. The LNS router uses the media-rate information to define the bandwidth of the corresponding member-link session. If the upstream connection at the LAC is MLPoE, MLPoEoVLAN, or MLPoEoQinQ, the DSLAM may provide the media rate information to the LAC. If the DSLAM does not provide the media rate, the member-link session bandwidth can be configured using

the **l2tp tx-speed rate** and **l2tp rx-speed rate** commands within the **vpdn-group** configuration command or downloaded from the RADIUS server using the **l2tp-tx-speed** and **l2tp-rx-speed** attributes.

MTU

For MLP Virtual Access bundles (IP and IPv6), the default Layer 3 MTU value is 1500. When the MLP bundle's member links are Ethernet, as in MLPoE, MLPoEoVLAN, and MLPoEoQinQ, the default MTU value of 1500 may cause an issue when sending IP packets that are close to this size.

For example, when a router sends a 1500-byte IP packet over MLPoE, the actual packet size transmitted is 1528: 14 (Ethernet header) + 8 (PPPoE header) + 6 (MLP header) + 1500 (IP) = 1528. The peer router drops the incoming packet as a **giant** because it exceeds the default expected maximum packet size.

The 1500-byte MTU size does not take into account any PPPoE or MLP header overhead, and hence, causes packets greater than 1493 bytes to be dropped by the peer. To address this issue, perform one of the following tasks:

- Lower the MTU on the MLP bundle to 1492.
- Increase the MTU on the Ethernet interface to 9216, the maximum MTU size supported on Cisco ASR 1000 Series Aggregation Services Routers.



Note

In Cisco ASR 1000 Series Route Processor 1 (RP1), 2RU, and 2RU-Fixed chassis, the MTU size for the Management Ethernet interface (interface gigabitethernet 0) is up to 2370 bytes.

Downstream LFI

Although LFI is thought of as a single feature, it is actually two independent features within MLP. MLP link fragmentation allows larger packets to be Layer 2 fragmented by MLP, and the fragments to be distributed across the various member links in the MLP bundle. These fragments are MLP encapsulated and sequenced. These fragments are then collected, reordered, and reassembled at the peer termination point for the MLP bundle interface.



Note

For more information about interleaving with QoS, see the *Quality of Service* section..

Interleaving enables you to reduce transmission delay on delay-sensitive voice, video, and interactive application data by interleaving it with the MLP fragments. When interleaving is configured, the packets on the bundle interface that QoS classifies as priority packets are interleaved. These priority packets are PPP encapsulated and interleaved with the MLP-encapsulated fragments or packets. When the peer router receives the PPP packets, they can be immediately forwarded, whereas, the received MLP-encapsulated packets have to be reordered and reassembled before being forwarded. While link fragmentation and interleaving can be configured on any multilink bundle, this LFI functionality is beneficial only on bundles of 1 Mbps or less. Packet transmission delays of higher bandwidth bundles are such that QoS prioritization of priority traffic should be sufficient to guarantee preferential treatment of the priority traffic without the need for LFI.

One downside of interleaving is that when there are two or more links in an MLP bundle, the order of the PPP-encapsulated packets cannot be guaranteed. In most applications sending data, such as, voice, video, and Telnet, this is not an issue because the gap between the packets on a given flow is large enough that the packets

must not pass each other on the multiple links in the bundle. Since the order cannot be guaranteed for the priority PPP-encapsulated packets that are interleaved, IP Header Compression (IPHC) is skipped on any packet that is classified as priority-interleaved packet. IPHC continues to occur for nonpriority packets that are sent as MLP encapsulated because MLP guarantees reordering before the packets are forwarded to IPHC.

The Multi-Class Multilink Protocol (MCMP) (RFC-2686) addresses the issues related to ordering of priority-interleaved packets. Currently, the MCMP is not supported on the Cisco ASR 1000 Series Aggregation Services Routers.

MLP LFI must be configured on the Cisco ASR 1000 Series Aggregation Services Routers to enable LFI.

In the context of interface multilink or interface virtual template, use any of the following commands to enable link fragmentation:

- **ppp multilink fragment delay** (delay in milliseconds)
- **ppp multilink fragment delay** (maximum fragment size, in bytes)
- **ppp multilink interleave**

For MLP using serial links, link fragmentation can also be enabled by configuring the **ppp multilink fragment size** (maximum fragment size, in bytes) command on the member-link serial interface.

If the MLP bundle has only one active member link and interleaving is not enabled, MLP fragmentation is disabled. In addition, all the packets are sent PPP encapsulated instead of MLP encapsulated. When a second link in the bundle becomes active or interleaving is enabled, MLP and fragmentation is enabled.

If the **ppp multilink interleave** command is not configured, only MLP link fragmentation is enabled. To enable interleaving, you must also configure the **ppp multilink interleave** command at the interface multilink level or the interface virtual template level. In addition to configuring interleaving as indicated here, you must also define a QoS policy with one or more priority classes, and attach the QoS to this interface using the **service-policy output** *policy-map-name* command. This command classifies the priority traffic, that is interleaved by the MLP.

See the QoS and LFI configuration examples in the “Configuring Multilink PPP Connections” chapter in the *Wide-Area Networking Configuration Guide: Multilink PPP*.

When configuring MLP fragmentation on the various Cisco platforms, the functionality of MLP fragmentation and interleaving support on the various platforms may differ. This section explains the configuration options and their interpretation in the context of the Cisco ASR 1000 Series Aggregation Services Routers.

Based on the values of the MLP fragmentation configuration commands, the MLP feature calculates two values that are used during MLP fragmentation: link weight and maximum fragment size. These parameters are calculated for each member link in the bundle.

First, a link weight must be determined for each member link. The link weight indicates the number of bytes, and the MLP uses this value to balance the data amongst the links in the bundle. This parameter is especially important when the links in a bundle are of unequal bandwidth. The link weight is based on a combination of the bandwidth of the member link and the PPP multilink fragment delay value. If you do not configure the fragment delay value, a default delay value of 30 milliseconds is used:

Link Weight = (Member Link Interface Bandwidth in bps/8) * Fragment Delay

**Caution**

Configuring the fragment delay to a smaller value results in smaller fragment size because the fragment delay value determines the default fragment size on the member link. This, in turn, implies loss of bandwidth due to the added Layer 2 header overhead. This is important for broadband MLP, which can have Layer 2 headers of 4 to 58 bytes in length.

The default maximum fragment size must be calculated per member link. The default maximum fragment size used will be the lesser value obtained from either of the following calculations:

- Link Weight – Multilink PPP + PPP Header Overhead (8)
- Interface MTU – Multilink PPP Header Overhead (4)

After the default maximum fragment size is calculated, if you have configured the **ppp multilink fragment size** (maximum) command at the multilink, virtual template, or serial interface level, the default maximum fragment size is compared against the configured maximum value and is capped accordingly. If the fragment size is configured at the serial interface level and the multilink interface level, the serial interface configuration takes precedence.

MLP Fragmentation Model

Earlier, some Cisco platforms supported a legacy MLP fragmentation model that was enabled by default if all the following criteria were met:

- Two or more active member links exist in the bundle.
- All the member links have equal bandwidth.
- No other form of multilink fragmentation or interleave commands are configured on the bundle or member-link interface.

In the legacy model, there were many instances when fragmentation was enabled by default without users being aware that it was configured. In addition, packets of moderate length could be fragmented. This did not provide the expected throughput on the bundle due to the added packet Layer 2 overhead introduced by MLP fragmentation.

On the Cisco ASR 1000 Series Aggregation Services Routers, this model of MLP fragmentation was supported until Cisco IOS XE Release 3.7.0. Effective from Cisco IOS XE Release 3.7.1, the Cisco ASR 1000 Series Aggregation Services Routers do not support this mode of MLP fragmentation. Therefore, you must now explicitly configure the multilink fragmentation or interleaving to enable MLP fragmentation.

Effective from Cisco IOS XE Release 3.7.1, the following MLP configuration commands are ignored by the Cisco ASR 1000 Series Aggregation Services Routers:

- **ppp multilink fragment disable**
- **ppp multilink fragment maximum** *maximum number of fragments per packet*

IP Type of Service Reflect

Effective from Cisco IOS XE Release 3.7.(0)S, support for the IP Type of Service (ToS) Reflect feature was added on the VPDN group or VPDN template for the L2TP tunnel when the Cisco ASR 1000 Series Aggregation

Services Routers act as LNS devices for broadband MLP sessions. Later, this feature was also added to the following maintenance releases: Cisco IOS XE 3.4.2, 3.5.1, and 3.6.2.

The IP Type of Service (ToS) Reflect feature allows the IP header ToS value from the inner IP header to be reflected in the ToS of the outer L2TP IP header.



Caution

To prevent MLP packet reordering and fragment or packet holes, the ToS data should not be used to reclassify and requeue or drop packets at the LAC. Any drops or reordering of MLP packets may cause MLP reordering or reassembly delays and additional packet loss in the receiving CPE device.

The following example shows how to configure IP ToS reflect:

```
vpdn-group vpdn-1
accept-dialin
protocol l2tp
virtual-template 1
session-limit 100
terminate-from hostname VPDN-1
lcp renegotiation always
no l2tp tunnel authentication
ip tos reflect
```

IP Tunnel Marking

Effective from Cisco IOS XE Release 3.7.1, support was added for setting the ToS value in the outer L2TP IP header using the QoS set tunnel action or the policer set tunnel action.

The following configuration options of the set actions are supported when applied to the output QoS policy of the multilink virtual template interface. This functionality is not supported in the Model-F QoS policy attached to the member-link parent subinterface.

- set ip dscp tunnel xx
- set ip prec tunnel xx
- set dscp tunnel xx
- set prec tunnel xx
- police set-dscp-tunnel-transmit xx
- police set-prec-tunnel-transmit xx

The following example shows how to set the ToS value using the police set-prec-tunnel-transmit option:

```
policy-map ppp
class class-default
police cir 4000000 conform-action set-prec-tunnel-transmit 3
Set action example:
policy-map ppp
class gold
set ip prec tunnel 1
```

Unsupported Features

The Cisco ASR 1000 Series Aggregation Services Routers do not support the following MLP features:

- In-Service Software Upgrade (ISSU) and Stateful Switchover (SSO) for MLP bundles
- The broadband L4 Redirect feature and the Intelligent Services Gateway feature
- Per-user firewall
- Lawful intercept
- MLP with MPLS-TE FRR
- Change of Authorization (CoA)
- Layer 2 input QoS classification
- The Multiclass Multilink Protocol (MCMP) RFC 2686 extension to LFI
- Per-user Access Control Lists (ACLs) applied through the RADIUS server are not supported. However, ACLs applied through the virtual template definition for the bundle are supported.
- Only the MLP long-sequence number format is supported for the packet header format option.

Additional References for Multilink PPP Support

The following sections provide references related to the Multilink ppp protocol connections.

Related Documents

Related Topic	Document Title
Cisco IOS commands	Cisco IOS Master Commands List, All Releases
Configuring Multilink PPP Connections for Broadband and Serial Topologies	Configuring Multilink PPP Connections for Broadband and Serial Topologies
MLP	Wide-Area Networking Configuration Guide: Multilink PPP, Cisco IOS XE Release 3S
PPP commands	Cisco IOS Dial Technologies Command Reference
Broadband Configuration	Cisco IOS XE Broadband and DSL Configuration Guide
Cisco IOS Configuration Fundamentals	Cisco IOS Configuration Fundamentals Command Reference

Standards

Standard	Title
None	—

MIBs

MIB	MIBs Link
None	To locate and download MIBs for selected platforms, Cisco IOS releases, and feature sets, use the Cisco MIB Locator found at the following URL: http://www.cisco.com/go/mibs

RFCs

RFC	Title
RFC 1990	The PPP Multilink Protocol (MP)
RFC 2686	The Multi-Class Extension to Multi-Link PPP

Technical Assistance

Description	Link
<p>The Cisco Support website provides extensive online resources, including documentation and tools for troubleshooting and resolving technical issues with Cisco products and technologies.</p> <p>To receive security and technical information about your products, you can subscribe to various services, such as the Product Alert Tool (accessed from Field Notices), the Cisco Technical Services Newsletter, and Really Simple Syndication (RSS) Feeds.</p> <p>Access to most tools on the Cisco Support website requires a Cisco.com user ID and password.</p>	http://www.cisco.com/cisco/web/support/index.html

Feature Information for Multilink PPP Support

Table 2: Feature Information for Multilink PPP Support for Cisco ASR 1000 Series Routers

Feature Name	Releases	Feature Information
MLPoSerial	Cisco IOS XE Release 2.2.0S	In Cisco IOS XE Release 2.2.(0)S, support for MLPoSerial was introduced on the Cisco ASR 1000 Series Aggregation Services Routers.

Feature Name	Releases	Feature Information
MLPoBroadband with single-link bundles	Cisco IOS XE Release 3.4.0S	In Cisco IOS XE Release 3.4.(0)S, support for MLPoBroadband with single-link bundles was introduced on the Cisco ASR 1000 Series Aggregation Services Routers. Support for MLP upstream fragment reassembly was also added, but not for downstream fragmentation.
MLPoLNS and MLPoE/MLPoVLAN/MLPoQinQ with up to 8 links per bundle	Cisco IOS XE Release 3.7.1S	In Cisco IOS XE Release 3.7.1S, support for MLPoLNS, MLPoE, MLPoVLAN, and MLPoQinQ with up to eight links per bundle was introduced on the Cisco ASR 1000 Series Aggregation Services Routers. Support for downstream MLP LFI for all broadband MLPs was also added.
MLPoLNS Model F and IP Tunnel Marking	Cisco IOS XE Release 3.7.1S	In Cisco IOS XE Release 3.7.1S, support for MLPoLNS Model F and IP Tunnel Marking was introduced on the Cisco ASR 1000 Series Aggregation Services Routers. Note Model-F downstream shaping for MLPoLNS is not supported on the Cisco ASR 1002-X Router and the FP100 line card.
Multi member-link MLPPPoA/MLPPPoEoA (including DS LFI)	Cisco IOS XE Release 3.7.12S	In Cisco IOS XE Release 3.7.12S, support for Multi member-link MLPPPoA/MLPPPoEoA (including DS LFI) was introduced on the Cisco ASR 1000 Series Aggregation Services Routers.



Configuring Multilink PPP Connections for Broadband and Serial Topologies

This module describes how to configure Multilink PPP over broadband and serial interfaces. Configuring Multilink PPP over broadband includes configuring Multilink PPP over ATM (MLPoA), Multilink PPP over Ethernet (MLPoE), Multilink PPP over Ethernet over ATM (MLPoEoA), Multilink PPP over Queue-in-Queue (MLPoQinQ), and Multilink PPP over VLAN (MLPoVLAN).

- [Finding Feature Information, page 19](#)
- [Restrictions for Multilink PPP Connections for Broadband and Serial Topologies, page 20](#)
- [Information About Multilink PPP Connections for Broadband and Serial Topologies, page 21](#)
- [How to Configure Multilink PPP Connections for Broadband and Serial Topologies, page 32](#)
- [Configuration Examples for Multilink PPP Connections for Broadband and Serial Topologies, page 61](#)
- [Additional References for Multilink PPP Connections for Broadband and Serial Topologies, page 69](#)
- [Feature Information for Multilink PPP Connections for Broadband and Serial Topologies, page 70](#)

Finding Feature Information

Your software release may not support all the features documented in this module. For the latest caveats and feature information, see [Bug Search Tool](#) and the release notes for your platform and software release. To find information about the features documented in this module, and to see a list of the releases in which each feature is supported, see the feature information table.

Use Cisco Feature Navigator to find information about platform support and Cisco software image support. To access Cisco Feature Navigator, go to www.cisco.com/go/cfn. An account on Cisco.com is not required.

Restrictions for Multilink PPP Connections for Broadband and Serial Topologies

Multilink PPP over Broadband Restrictions

This section lists the common limitations and caveats for all broadband Multilink PPP models supported by Cisco software. For information about basic broadband restrictions, limitations, and caveats, see the *Broadband Access Aggregation and DSL Configuration Guide*.

- Some Cisco broadband Multilink PPP implementations support the creation of a Multilink PPP bundle for some broadband configurations either through a virtual template interface or through an interface multilink. Cisco software supports virtual template interfaces only for broadband Multilink PPP bundle types. Interface multilink and multilink groups are supported on Multilink PPP over serial interfaces (that is, nonbroadband Multilink PPP).



Note

A virtual access interface (VAI) will be created for a session that is based on a virtual template configuration.

- Cisco software supports a maximum of 4096 virtual template interfaces. In many cases, a single common virtual template configuration may be used to create multiple bundle VAI instances, especially for single-link bundle sessions.
- Depending on your release, there may be a limit of one link per Multilink PPP bundle. The **ppp multilink links maximum** command should be configured on the virtual template to ensure that requests for additional links in a bundle are rejected.
- Cisco In-Service Software Upgrade (ISSU) and stateful switchover (SSO) for broadband Multilink PPP sessions are not supported.

QoS Restrictions

- Quality of service (QoS) is supported only on a Multilink PPP bundle. QoS is not supported on PPP sessions that make up the Multilink PPP bundle. Multilink PPP does not function properly if queuing policies are attached to PPP sessions that make up the Multilink PPP bundle.
- QoS Bandwidth Remaining Ratio (BRR) is not supported with Multilink PPP. BRR will require QoS policies to be applied to PPP sessions that make up the Multilink PPP bundle, which will cause Multilink PPP to not function properly.

Information About Multilink PPP Connections for Broadband and Serial Topologies

Multilink PPP

The Multilink PPP feature provides load balancing functionality over multiple WAN links while providing multivendor interoperability and support for packet fragmentation, proper sequencing, and load calculation on both inbound and outbound traffic. The Multilink PPP feature supports the fragmentation and packet sequencing specifications described in RFC 1990.

Multilink PPP allows packets to be fragmented and fragments to be sent at the same time over multiple point-to-point links to the same remote address. Multiple links come up in response to a defined dialer load threshold. The load can be calculated on inbound or outbound traffic, as required, for the traffic between specific sites. Multilink PPP provides bandwidth on demand and reduces transmission latency across WAN links.

Multilink PPP can work over synchronous and asynchronous serial type of single or multiple interfaces that have been configured to support both dial-on-demand rotary groups and PPP encapsulation.

Multilink PPP Bundles

Multilink PPP combines multiple physical links into a logical bundle called a Multilink PPP bundle. A Multilink PPP bundle is a single, virtual interface that connects to the peer system. Having a single interface (Multilink PPP bundle interface) provides a single point to apply hierarchical queueing, shaping, and policing to traffic flows. Individual links in a bundle do not perform any hierarchical queueing. None of the links have any knowledge about the traffic on parallel links. Hierarchical queueing and quality of service (QoS) cannot be applied uniformly to the entire aggregate traffic between a system and its peer system. A single, virtual interface also simplifies the task of monitoring traffic to the peer system (for example, all traffic statistics run on one interface).

Figure 1: Multilink PPP Bundle

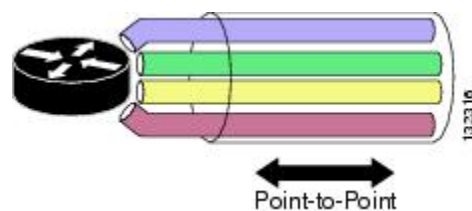

Multilink PPP Bundles and PPP Links

Multilink PPP works with fully functional PPP interfaces. A Multilink PPP bundle can have multiple links connecting peer devices. These links can be serial links or broadband links (Ethernet or ATM). As long as each link behaves like a standard serial interface, mixed links work properly in a bundle.

To designate a link to a specified bundle, use the **ppp multilink group** command for configuring the link. This command restricts the link to join only the specified bundle. When a link negotiates to join a Multilink PPP bundle, the link must provide proper identification that is associated with the Multilink PPP bundle. If the negotiation is successful, the link is assigned to the requested Multilink PPP bundle. If the link provides identification that coincides with the identification associated with a different Multilink PPP bundle in the system or if the link fails to match the identity of a Multilink PPP bundle that is already active on the multilink group interface, the connection terminates.

A link joins a Multilink PPP bundle only if it negotiates to use the bundle when a connection is established and the identification information exchanged matches that of an existing bundle.

When you configure the **ppp multilink group** command on a link, the command applies the following restrictions on the link:

- The link is not allowed to join any bundle other than the indicated group interface.
- The PPP session must be terminated if the peer device attempts to join a different bundle.

A link joins a bundle only when the identification keys for that link match the identification keys for an existing bundle. (See the “Factors that Govern a Link Joining a Bundle” section.) Merely configuring the **ppp multilink group** command on a link does not allow the link to join the corresponding bundle; the link must have matching identification keys to join the corresponding bundle. Identification keys are always used as the determining factor for matching links with bundles.

Because the **ppp multilink group** command merely places a restriction on a link, any Multilink-PPP-enabled link that is not assigned to a particular multilink group can join the dedicated bundle interface if the Multilink-PPP-enabled link provides correct identification keys for that dedicated bundle. Removing the **ppp multilink group** command from an active link that is currently a member of a multilink group does not make that link leave the bundle because the link is still a valid member of the multilink group. However, the link is no longer restricted to this one bundle.

The table below lists the different configurations of Multilink PPP and the number of links supported by each one of them.

Feature Name	Number of Links Supported Per Bundle
Multilink PPP over Serial	10
Multilink PPP over Ethernet	1 or 8 (depending on your release)
Multilink PPP over Ethernet over VLAN	1 or 8 (depending on your release)*
Multilink PPP over Ethernet over QinQ	1 or 8 (depending on your release)*
Multilink PPP over Ethernet over ATM	1 or 8 (depending on your release)*
Multilink PPP over ATM (AAL5MUX, AL5SNAP)	1 or 8 (depending on your release)*
Multilink PPP over LNS	1 or 8 (depending on your release)*

* See the Release Notes specific to your platform and release.

Link Fragmentation and Interleaving

The main benefit of Multilink PPP is the support for link fragmentation and interleaving (LFI). LFI minimizes packet latency on delay-sensitive voice, video, and interactive applications when data is sent over low-speed interfaces.

With LFI, the latency of delay-sensitive traffic is minimized because Multilink PPP breaks the nonpriority or nonlatency-sensitive traffic into smaller fragments. The delay-sensitive traffic is then PPP encapsulated and interleaved with nonpriority Multilink PPP fragments or packets. At the receiver, Multilink PPP fragments or packets are reordered and reassembled while the PPP-encapsulated packets are received and immediately forwarded. (Multilink PPP is bypassed; no reordering or reassembly is performed.)

Types of Multilink PPP Bundle Interfaces

Multilink PPP bundle interfaces can be one of the following types:

- Multilink group interfaces
- Virtual access interfaces (VAIs)

Both these types of interfaces provide the same level of PPP and multilink functionality after a bundle is established. All PPP and multilink-related features run identically on a bundle.

Multilink Group Interface

A multilink group interface is a static interface that exists whether or not it is being used at a particular point in time. A static interface is defined in the startup configuration file on a device. This type of interface is created automatically when a device boots up. Multilink group interfaces are dedicated to specific remote users. These interfaces are used in leased-line environments, where you have information about all physical links connections and where the number of users is defined by the number of physical connections in the system.

Multilink group interfaces allow you to track a specific user's activity. By examining a user's associated interface, you can easily see whether a user is connected and how much traffic the user has sent or received. You can monitor the state of a multilink group interface for issues such as network outages.

Virtual Access Interface

A virtual access interface (VAI) is a type of interface that is used for Multilink PPP bundles, specifically for Multilink PPP over broadband. A VAI is created dynamically for a multilink connection and released as soon as a multilink connection is torn down. A bundle interface of this type exists only as long as a user is connected. As soon as a user disconnects, a virtual access interface no longer exists.

A VAI is the default type of bundle interface when Multilink PPP is running in a broadband topology. For broadband topologies, a VAI replaces multilink group interfaces, which are used in serial topologies.

The use of a VAI has the following advantages:

- The number of bundle interfaces depends only on the number of currently active multilink users and not on the size of the user database.

- Because a local configuration source does not exist for per-user information, this information is derived from another source, such as an authentication, authorization, and accounting (AAA) server.

The disadvantage of using a VAI lies in its monitoring capability. A multilink group interface, used in serial deployments, allows the monitoring of each user's traffic through a serial link. With a VAI, there is no dedicated interface defined in a device's configuration file. Therefore, you must track a user's activity by using other means, such as the accounting mechanism of an AAA server.

Factors that Govern a Link Joining a Bundle

A link joins a bundle when identification keys for that link match identification keys for an existing bundle.

The following two keys define the identity of a remote system: the PPP username and Multilink PPP endpoint discriminator. PPP authentication mechanisms (for example, password authentication protocol [PAP] or Challenge-Handshake Authentication Protocol [CHAP]) learn the PPP username. The endpoint discriminator is an option negotiated by the Link Control Protocol (LCP). Therefore, a bundle consists of links that have the same PPP usernames and endpoint discriminators.

A link that does not provide a PPP username or an endpoint discriminator is an anonymous link. Multilink PPP collects all anonymous links into a single bundle that is referred to as the anonymous bundle or the default bundle. Typically, there can be only one anonymous bundle. Any anonymous links that negotiate Multilink PPP join (or create) the anonymous bundle.

When you use multilink group interfaces, more than one anonymous bundle is allowed. When you preassign a link to a Multilink PPP bundle by using the **ppp multilink group** command and the link is anonymous, the link joins the bundle interface to which it is assigned if the interface is not already active and is associated with an anonymous user.

Multilink PPP determines the bundle a link joins by following these steps:

- 1 When a PPP session is initiated, Multilink PPP creates a bundle name identifier for the link.
- 2 Multilink PPP then searches for a bundle with the same bundle name identifier. The following scenarios are possible:
 - If a bundle with the same identifier exists, the link joins that bundle.
 - If a bundle with the same identifier does not exist, Multilink PPP creates a new bundle with the same identifier as the link, and the link becomes the first link to join the bundle.

The table below describes commands and associated algorithms that are used to generate a bundle name. In the table, "username" typically means an authenticated username; however, an alternate name can be used instead. The alternate name is usually an expanded version of the username (for example, virtual private dialup network [VPDN] tunnels might include the network access server name) or a name derived from other sources.

Table 3: Bundle Name Generation Commands

Command	Bundle Name Generation Algorithm
multilink bundle-name authenticated	<p>The bundle name is derived from the username that is defined on a peer device. The username is passed from the peer device during PPP negotiation.</p> <p>If a peer does not provide a username, the algorithm uses the peer's endpoint discriminator.</p> <p>Note The authenticated keyword specifies that the bundle name should be derived by Cisco software. Because multiple bundles may exist on a device concurrently, Cisco software must ensure a unique name for each bundle. The endpoint discriminator is ignored entirely, unless it is the only name that can be found.</p> <p>The multilink bundle-name authenticated command is the default naming policy.</p>
multilink bundle-name both	The bundle name is a concatenation of the username and the endpoint discriminator.
multilink bundle-name endpoint	<p>The bundle name is a peer's endpoint discriminator.</p> <p>If there is no endpoint discriminator, the algorithm uses the peer's username.</p>

Rate of Session Establishment for Multilink PPP Bundles

When devices running Cisco software begin negotiating a large number of broadband sessions, a peer device may be constrained by its processing capabilities. This limitation may cause an excessive number of timeouts (because the peer device may be renegotiating hundreds of sessions due to timeouts) while trying to negotiate PPP parameters. Cisco software provides an internal mechanism to control the rate of session establishment (to prevent excessive timeouts) for broadband sessions by using the Call Admission Control (CAC) functionality. CAC can be configured to control the number of sessions that can be negotiated in a given period of time. Controlling the rate of session establishment is also known as throttling. The mechanism of throttling helps to prevent unnecessary negotiation timeouts with slower devices. The following commands show how to configure the CAC functionality:

```
Device(config)# call admission new-model
Device(config)# call admission limit 500
Device(config)# call admission cpu-limit 80
Device(config)# call admission pppoe 10 1
Device(config)# call admission pppoa 10 1
Device(config)# call admission vpdn 10 1
```

- The **call admission new-model** command enables the new-model-based CAC, which regulates session establishment based on both CPU utilization and incoming session requests.
- The **call admission limit** command (also referred to as charge limit) sets the maximum total concurrent charge threshold. If this threshold is exceeded, any additional session requests are rejected.

- The **call admission cpu-limit** command specifies the CPU utilization threshold, as a percentage. If this threshold is exceeded, new sessions are rejected. CAC uses the 5-second CPU utilization of IOS daemon (IOSd) for this calculation.
- Session requests are rejected if either the **cpu-limit** (80% in the example above) or the charge **limit** (1000 in the example above) is exceeded.
- The **call admission pppoe 10 1** command specifies the charge values for a single PPP over Ethernet (PPPoE) session. In the above example, the session charge is 10, and the lifetime is 1 second. The charge values are set per call type (PPP over ATM [PPPoA], PPPoE, or virtual private dialup network [VPDN]). The extended lifetime is calculated as the sum of two lifetime values. For the above example, the extended lifetime is $1 + 1 = 2$.
- You can calculate calls per second (CPS) as follows:

$$\text{CPS} = \text{Charge Limit} / (\text{Session Charge} * \text{Extended Lifetime})$$
 For the above example, $\text{CPS} = 500 / (10 * 2) = 25$

For a more detailed explanation, refer to the “Broadband Scalability and Performance” module in the *Cisco ASR 1000 Series Aggregation Services Routers Software Configuration Guide*.

Multilink PPP Packet Overhead

Multilink PPP encapsulation adds six extra bytes (four header and two checksum) to each outbound packet. These overhead bytes reduce the effective bandwidth of a connection; therefore, the throughput for a Multilink PPP bundle is slightly less than that for an equivalent bandwidth connection that is not using Multilink PPP. If the average packet size is large, the extra Multilink PPP overhead is not readily apparent. However, if the average packet size is small, the extra overhead becomes more noticeable.

Multilink PPP fragmentation adds additional overhead to a packet. Each fragment contains six bytes of Multilink PPP header plus a link encapsulation header. The size of the link encapsulation header varies based on the topology of a network. The Layer 2 headers for Ethernet, ATM, and serial interfaces add different number of bytes to a packet.

Multilink PPP over Serial Interfaces

The Multilink PPP over Serial Interfaces feature enables you to bundle T1 interfaces into a single, logical connection called a Multilink PPP bundle. (See the “Multilink PPP Bundles” section.) The Multilink PPP over Serial Interfaces feature also provides the following functionalities:

- Load balancing—Multilink PPP provides bandwidth on demand and uses load balancing across all member links (up to ten) to transmit packets and packet fragments. Multilink PPP mechanisms calculate the load on inbound or outbound traffic between specific sites. Because Multilink PPP splits packets and fragments across all member links during transmission, Multilink PPP reduces transmission latency across WAN links. Ideally, all member links in a bundle would be of the same bandwidth (for example, T1s). Load balancing and fragmentation and interleaving also allow for a mix of unequal cost member links for situations where a small increment in the bundle bandwidth is required.
- Increased redundancy—Multilink PPP allows traffic to flow over remaining member links when a port fails. When you configure a Multilink PPP bundle that consists of T1 lines from more than one line card and if one line card stops operating, part of the bundle on other line cards continues to operate.
- Link fragmentation and interleaving (LFI)—The Multilink PPP fragmenting mechanism fragments large, nonreal-time packets and sends fragments at the same time over multiple point-to-point links to the same

remote address. Smaller, real-time packets remain intact. The Multilink PPP interleaving mechanism sends real-time packets between fragments of nonreal-time packets, thus reducing real-time packet delay.

The figure below shows a Multilink PPP bundle that consists of T1 interfaces from three T3 interfaces.

Figure 2: Multilink PPP Bundle for Multilink PPP over Serial Interfaces

You can combine up to ten T1s to create a Multilink bundle.
The bundle can include T1 channels assigned to different T3s.

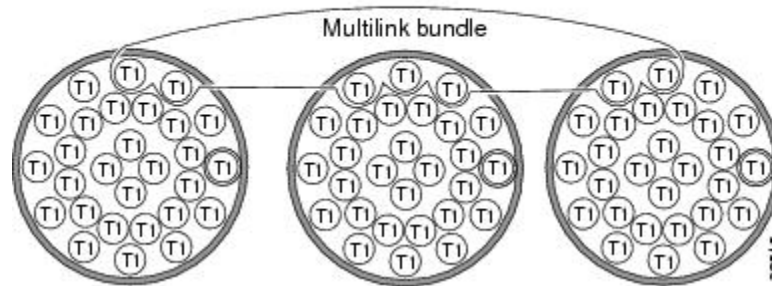

Multilink PPP over Broadband

The Multilink PPP over Broadband feature allows you to combine Multilink PPP over Ethernet (MLPoE) and Multilink PPP over ATM (MLPoA) links into a multilink bundle. Functionally, Multilink PPP over broadband is the same as Multilink PPP over serial interfaces, with the exception of interface management. In Multilink PPP over serial interfaces, interfaces are statically defined in the configuration database, that is, in the startup configuration. In Multilink PPP over broadband, link interfaces are created dynamically by Cisco software while negotiating a PPP session.

The Multilink PPP feature operates in the following two deployment schemes: “PTA mode” and “LNS mode.” In the PPP termination and aggregation (PTA) mode, a device acts as the PTA device and terminates Multilink PPP sessions coming from the customer premises equipment (CPE). In the Layer 2 Tunneling Protocol (L2TP) Network Server (LNS) mode, a device terminates Multilink PPP sessions (carried in a Layer 2 tunnel that originates on a L2TP Access Concentrator [LAC] device) coming from the CPE device.



Note

Cisco software allows a device to function as a LAC switch. Therefore, in the LNS mode, Cisco software can run on both LAC and LNS devices. A Cisco device cannot act as a CPE device.

Cisco software can terminate Multilink PPP over ATM (MLPoA) ATM adaptation layer 5 (AAL5) multiplexer (MUX) or AAL5 Subnetwork Access Protocol (SNAP), Multilink PPP over Ethernet (MLPoE), Multilink PPP over Ethernet over ATM (MLPoEoA) AAL5 SNAP, Multilink PPP over Ethernet over Queue-in-Queue (MLPoEoQinQ), or Multilink PPP over Ethernet over VLAN (MLPoEoVLAN) sessions acting as the PTA node. In the LNS mode, Cisco software can terminate Multilink PPP over LNS (MLPoLNS) sessions by using Ethernet (Gigabit Ethernet or 10 Gigabit Ethernet) and ATM (AAL5 MUX and AAL5 SNAP) as the LAC-to-LNS connection to the LAC device. Cisco software also provides support to act as a LAC device to switch broadband Multilink PPP sessions between a CPE or Digital Subscriber Line Access Multiplexer (DSLAM) and an LNS device.

PTA Mode

In the PPP termination and aggregation (PTA) mode, Multilink PPP bundles are terminated at the customer premises equipment (CPE) and at the PTA device. A PTA device terminates the PPP or Multilink PPP session and assigns the network layer address to a client. The client data, present as payload in the Multilink PPP packet, is then forwarded to the backbone network. Depending on the access network, PPP or Multilink PPP frames can be transported to the PTA device by using PPP over ATM (PPPoA) or PPP over Ethernet (PPPoE).

The figure below shows the PTA mode.

Figure 3: PTA Mode

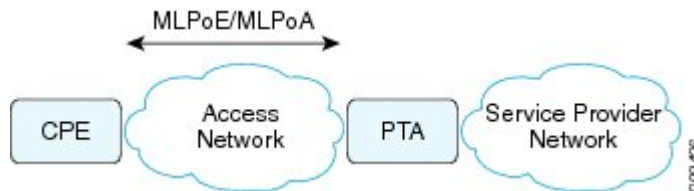

LNS Mode

A customer premises equipment (CPE) provides access to a network through various types of access network topologies, including ISDN, asymmetric digital subscriber line (ADSL), and Fiber to the Home (FTTH). If the network protocol used by the CPE device is IPv4, the IP payload will be carried over PPP or Multilink PPP, and the L2TP Access Concentrator (LAC) device will carry the client PPP or Multilink PPP session data to the Layer 2 Tunneling Protocol (L2TP) Network Server (LNS) device by using Layer 2 Tunneling Protocol Version 2 (L2TPv2). The LNS device terminates the PPP or Multilink PPP session and assigns the client its network layer address. The client data, present as the payload in the IPv4 packet, is then forwarded to the backbone network. Depending on the access network, PPP or Multilink PPP frames can be transported to the LAC device by using PPP over ATM (PPPoA) or PPP over Ethernet (PPPoE).



Note

Because the LAC device performs Layer 2 Forwarding (L2F) between a CPE and an LNS device, the LAC device does not physically terminate the Multilink PPP session; the LAC device forwards the Multilink PPP session traffic by using L2F.

CPE and LAC devices exchange PPP or Multilink PPP packets that are typically encapsulated using the PPPoE protocol and carried over an Ethernet network. The requirements of an LNS device are independent of protocols that are in use between clients and the LAC device. The LAC device creates L2TPv2 tunnels to all LNS devices to which clients need termination. Multiple tunnels can exist between a given LAC-to-LNS pair of devices for load sharing and redundancy considerations.

The figure below shows the LNS mode.

Figure 4: LNS Mode

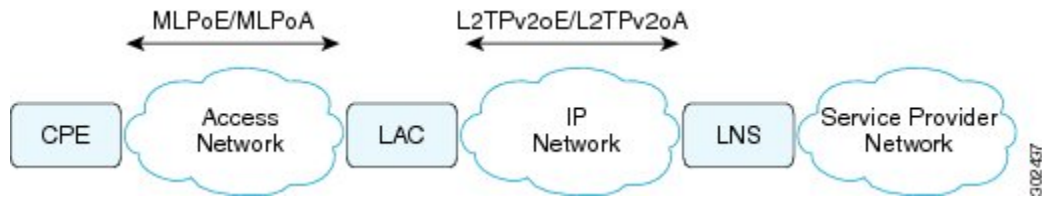

For each PPP or Multilink PPP session that is initiated by the CPE device, the LAC device signals the LNS device to add another session to the tunnel. After a session is set up, all traffic from the client, including PPP control packets, is forwarded to the LNS device. After the decision to negotiate the initial Link Control Protocol (LCP) and forward packets to an LNS device has been made, the LAC device becomes Layer 2 transparent to subsequent packets that are received from the client and the LNS device, including further PPP control messages. PPP or Multilink PPP sessions are terminated at the LNS device, and IP packets from the client are routed on the attached ISP or corporate network towards their final destination. The LNS device performs authentication, authorization, and accounting (AAA) actions on PPP or Multilink PPP sessions.



Note

In the case of PPP control packet exchanges at PPP or Multilink PPP session initiation time, the Multilink PPP session is terminated at the CPE device and the LNS device, not at the LAC device. The LAC device does not have the knowledge that this is a Multilink PPP session. As a result, when the client CPE first initiates a PPP-LCP connection, the Multilink (Maximum Receive Reconstructed Unit [MRRU]) negotiation included as part of the LCP negotiation may fail if the LAC device has not yet established the connection with the LNS device (which is typically the case). When a connection between the LAC device and the LNS device is established, the LNS device can renegotiate Multilink (MRRU) LCP options with the CPE device, and the two peer devices can then establish an end-to-end Multilink PPP connection.

Performance- and Scalability-Related Commands

When working in large-scale network configurations with many Multilink PPP (or PPP) subscribers, the traffic load when bringing up a scaled session can overwhelm the network and packets may be dropped. For example, such a scenario may occur after a full device reload or after an outage on a network interface that supports large numbers of users.

To minimize recovery issues due to dropped session establishment packets, we recommend that you configure the following commands on the multilink interface (that is, interface multilink, virtual template, or serial member link interfaces):

```
Device(config)# interface GigabitEthernet 1/0/0
Device(config-if)# ppp max-configure 30
Device(config-if)# ppp max-failure 30
Device(config-if)# ppp timeout retry 5
Device(config-if)# keepalive 30
```

The above commands are the recommended starting points. These values can be configured as required depending on the scale of the network.

Some other issues related to network packet drops, observed when bringing up large-scale networks, include PPP or Multilink PPP sessions coming up but missing adjacencies in IP forwarding tables (that is, IP addresses are not assigned to sessions).

The **keepalive** command listed above affects how quickly a link is flagged as disabled if it is no longer functional. If a Multilink PPP bundle is used with multiple member link sessions and if one or more links are removed, the higher the keepalive interval the longer Multilink PPP will require to detect the disabled link and remove from the list of member links. This delay can cause a period of packet loss and delays on the bundle until the disabled link has been detected. The default keepalive interval, if not specified by the user, is 10 seconds, and the default number of keepalive retries is 4.

**Note**

When a link is disabled due to a loss of signal, shut down, or due to a major alarm type of condition, the disabled link may be detected outside of the keepalive mechanism and reported as disabled before the keepalive timeout. The keepalive mechanism applies wherever the link is disabled but appears functional at the physical layer.

When configuring Broadband Aggregation (BBA) groups over an Ethernet interface, there are limits that must be adjusted to match the scale of the configuration. The number of broadband sessions can be limited per MAC address, per VLAN, and per virtual circuit (VC). The following example shows how to use the **bba-group pppoe** command to configure a BBA group over Ethernet:

```
Device(config)# bba-group pppoe global
Device(config-bba-group)# sessions per-mac limit 2000
Device(config-bba-group)# sessions per-vlan limit 2000
Device(config-bba-group)# sessions per-vc limit 2000 threshold 2000
```

If these per-session numbers are too low, there will be fewer established sessions between devices.

Multilink PPP over ATM on the PTA Device

Cisco software supports Multilink PPP over ATM (MLPoA) by using single-link and multilink bundles. Cisco software supports MLPoA over ATM adaptation layer 5 (AAL5) multiplexer (MUX) or AAL5 Subnetwork Access Protocol (SNAP).

The network topology and functional support for MLPoA is similar to the Multilink PPP over Ethernet (MLPoE) topology on the PTA device. The difference is that the connection between the PTA device and downstream devices is ATM instead of Ethernet.

Multilink PPP over Ethernet over ATM on the PTA Device

Cisco software supports Multilink PPP over Ethernet over ATM (MLPoEoA) by using single-link and multilink bundles. Cisco software supports MLPoEoA over ATM adaptation layer 5 (AAL5) Subnetwork Access Protocol (SNAP).

The network topology and functional support for MLPoEoA is similar to the Multilink PPP over Ethernet (MLPoE) topology on the PTA device. The difference is that the connection between the PTA device and downstream devices is ATM instead of Ethernet.

Multilink PPP over LNS

Cisco software supports Multilink PPP over LNS (MLPoLNS) by using single-link and multilink bundles. The data link layer for MLPoLNS is Layer 2 Tunneling Protocol Version 2 (L2TPv2). For MLPoLNS, Ethernet is used for transport between L2TP Network Server (LNS) and L2TP Access Concentrator (LAC) devices.

The Multilink PPP over LNS feature bundles one or more virtual private dialup network (VPDN) sessions in a single logical connection, which forms a Multilink PPP bundle on the LNS device. From a Multilink PPP perspective, Multilink PPP over LNS is similar to Multilink PPP over ATM or over Ethernet or over Ethernet

over ATM, except that in this case, Multilink PPP or PPP packets are L2TPv2 encapsulated. The bandwidth of a member link session can be determined on a LAC device by using the *connect speed* attribute-value pair. The L2TP tunnel between a LAC device and an LNS device carries both PPP and Multilink PPP traffic. The LAC device acts as a switch and forwards both PPP and Multilink PPP session packets between the CPE device and the LNS device. The figure below shows a LAC-to-LNS dialup network.

Figure 5: Dialup LAC to LNS

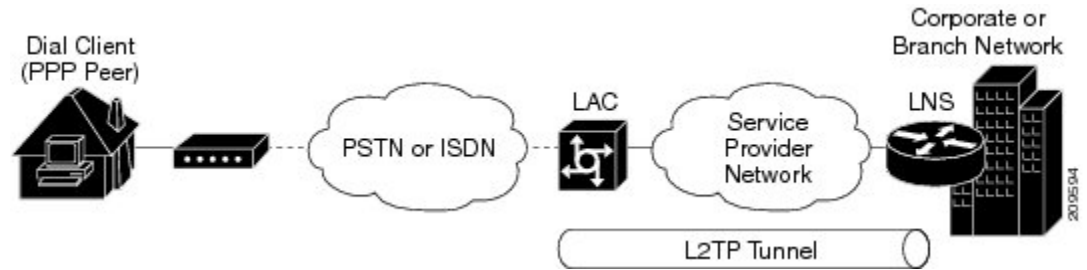

L2TP-client-initiated tunneling allows a client device to initiate L2TP tunnels. A client device can initiate an L2TP tunnel to the LNS device without the intermediate Network Access Server (NAS) participating in tunnel negotiation or establishment. The benefit of L2TP-client-initiated tunneling is that client devices can initiate L2TP tunnels.

The figure below shows an example of a client-initiated tunneling scenario. The client connects to the NAS through a medium, such as a dialup modem, Digital Subscriber Line (DSL), ISDN, or a cable modem, that supports PPP. The client can initiate an L2TP tunnel to the LNS device.

Figure 6: L2TPv2 Tunnel to an LNS Device

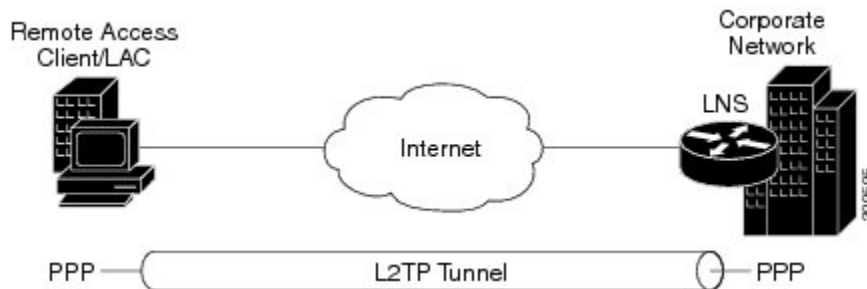

The L2TP Client-Initiated Tunneling feature uses a virtual PPP interface, which adds Layer 2 encapsulation to Layer 3 packets, allowing these packets to be sent to the LNS device over an L2TPv2 tunnel.

Switching Multilink PPP Traffic Through a LAC Device

Cisco software supports the switching of broadband Multilink PPP sessions between customer premises equipment (CPE) and LNS devices through a LAC device.

In the LAC switching mode, the LAC device provides the Multilink PPP over ATM (MLPoATM), Multilink PPP over Ethernet (MLPoE), or Multilink PPP over Ethernet over ATM (MLPoEoA) connection to the CPE device and the virtual private dialup network (VPDN) connection to the LNS device. The LAC-to-CPE connection may be any of the variations supported through MLPoA, MLPoE, or MLPoEoA in the PPP termination and aggregation (PTA) mode.

When switching Multilink PPP traffic through a LAC device, Multilink PPP sessions are not terminated. Multilink PPP sessions are terminated by CPE and LNS devices. The LAC device manages the establishment of the member link VPDN session between the CPE and LNS devices and the switching of the session data. Data from the CPE device is L2TPv2 encapsulated and passed to the LNS device. Data from the LNS device is stripped off of the L2TPv2 data and passed on to the CPE device.

QoS Traffic and Shaping

Quality of service (QoS) is applied to a Multilink PPP bundle by using a service policy. This policy is then applied to the Multilink PPP bundle interface, which appears as a PPP interface.



Note

For Multilink PPP over serial interfaces, the service policy is applied to the multilink interface configuration. For broadband topologies, the service policy is applied to the virtual template configuration.

QoS allows you to manually account for the extra overhead imposed by the external interface and other Layer 2 encapsulations by using the **account** and **user-defined** keywords in the **shape** command. One such example includes ATM cell overhead (extra bits or bytes are added to packets when running traffic on an ATM network). This additional overhead is not accounted for because the extra bytes are removed by the external interface before the QoS policy is applied to the packets. For more information, see the *QoS: Policing and Shaping Configuration Guide*.

How to Configure Multilink PPP Connections for Broadband and Serial Topologies

Configuring Multilink PPP

Before configuring Multilink PPP connections between CPE and PTA devices, you must configure Multilink PPP by performing the following tasks:

Creating a Multilink Bundle

SUMMARY STEPS

1. **enable**
2. **configure terminal**
3. **interface multilink** *group-number*
4. **ip address** *address mask*
5. **ppp multilink**
6. **ppp multilink group** *group-number*
7. **end**
8. **show ppp multilink**

DETAILED STEPS

	Command or Action	Purpose
Step 1	enable Example: Device> enable	Enables privileged EXEC mode. <ul style="list-style-type: none"> • Enter your password if prompted.
Step 2	configure terminal Example: Device# configure terminal	Enters global configuration mode.
Step 3	interface multilink <i>group-number</i> Example: Device(config)# interface multilink 10	Assigns a multilink bundle group number and enters interface configuration mode.
Step 4	ip address <i>address mask</i> Example: Device(config-if)# ip address 192.0.2.9 255.255.255.224	Assigns an IP address to the multilink interface.
Step 5	ppp multilink Example: Device(config-if)# ppp multilink	Enables Multilink PPP.
Step 6	ppp multilink group <i>group-number</i> Example: Device(config-if)# ppp multilink group 12	Restricts a physical link to join only the designated multilink-group interface.
Step 7	end Example: Router(config-if)# end	Exits interface configuration mode and returns to privileged EXEC mode.
Step 8	show ppp multilink Example: Device# show ppp multilink	Displays Multilink PPP bundle information.

Assigning an Interface to a Multilink Bundle



Caution

Do not install a route to the peer address while configuring a Multilink PPP lease line. The route can be disabled using the **no ppp peer-neighbor-route** command on the Multilink PPP bundle interface.

SUMMARY STEPS

1. **enable**
2. **configure terminal**
3. **interface serial** *slot/subslot/port*
4. **no ip address**
5. **encapsulation ppp**
6. **keepalive** *seconds*
7. **ppp multilink**
8. **ppp multilink group** *group-number*
9. **end**

DETAILED STEPS

	Command or Action	Purpose
Step 1	enable Example: Device> enable	Enables privileged EXEC mode. <ul style="list-style-type: none"> • Enter your password if prompted.
Step 2	configure terminal Example: Device# configure terminal	Enters global configuration mode.
Step 3	interface serial <i>slot/subslot/port</i> Example: Device(config)# interface serial 1/3/0	Assigns a multilink bundle group number and enters interface configuration mode.
Step 4	no ip address Example: Device(config-if)# no ip address	Removes any specified IP address.
Step 5	encapsulation ppp Example: Device(config-if)# encapsulation ppp	Enables PPP encapsulation.

	Command or Action	Purpose
Step 6	keepalive <i>seconds</i> Example: Device(config-if)# keepalive 50	Sets the frequency of keepalive packets.
Step 7	ppp multilink Example: Device(config-if)# ppp multilink	Enables Multilink PPP.
Step 8	ppp multilink group <i>group-number</i> Example: Device(config-if)# ppp multilink group 12	Restricts a physical link to join only the designated multilink-group interface.
Step 9	end Example: Device(config-if)# end	Exits interface configuration mode and returns to privileged EXEC mode.

Configuring Minimum Multilink PPP Links

Perform this task to configure the minimum number of links in a Multilink PPP bundle, which are required to keep that bundle active.

SUMMARY STEPS

1. **enable**
2. **configure terminal**
3. **interface multilink** *group-number*
4. **ppp multilink**
5. **ppp multilink min-links** *links* **mandatory**
6. **end**

DETAILED STEPS

	Command or Action	Purpose
Step 1	enable Example: Device> enable	Enables privileged EXEC mode. • Enter your password if prompted.

	Command or Action	Purpose
Step 2	configure terminal Example: Device# configure terminal	Enters global configuration mode.
Step 3	interface multilink <i>group-number</i> Example: Device(config)# interface multilink 10	Assigns a multilink bundle group number and enters interface configuration mode.
Step 4	ppp multilink Example: Device(config-if)# ppp multilink	Enables Multilink PPP.
Step 5	ppp multilink min-links <i>links</i> mandatory Example: Device(config-if)# ppp multilink min-links 5 mandatory	Specifies the required minimum number of links in a Multilink PPP bundle. • If the minimum number of links in the Multilink PPP bundle falls below the number specified by the <i>links</i> argument, the Multilink PPP bundle is disabled.
Step 6	end Example: Device(config-if)# end	Exits interface configuration mode and returns to privileged EXEC mode.

Changing the Default Endpoint Discriminator

By default, when the system negotiates the use of Multilink PPP with a peer device, the value that is supplied for the endpoint discriminator is the same as the username used for authentication. The username is configured for the interface by using the **ppp chap hostname** or **ppp pap sent-username** command. If not configured, the username defaults to the globally configured hostname (or stack group name if this interface is a Stack Group Bidding Protocol [SGBP] group member).

Perform this task to override or change the default endpoint discriminator.

SUMMARY STEPS

1. **enable**
2. **configure terminal**
3. **interface virtual-template** *number*
4. **ppp multilink endpoint** {*hostname* | **ip** *ip-address* | **mac** *lan-interface* | **none** | **phone** *telephone-number* | **string** *char-string*}
5. **end**

DETAILED STEPS

	Command or Action	Purpose
Step 1	enable Example: Device> enable	Enables privileged EXEC mode. <ul style="list-style-type: none"> • Enter your password if prompted.
Step 2	configure terminal Example: Device# configure terminal	Enters global configuration mode.
Step 3	interface virtual-template <i>number</i> Example: Device(config)# interface virtual-template 1	Creates a virtual template interface that can be configured and applied dynamically for creating VAIs and enters interface configuration mode.
Step 4	ppp multilink endpoint {hostname ip <i>ip-address</i> mac <i>lan-interface</i> none phone <i>telephone-number</i> string <i>char-string</i>} Example: Device(config-if)# ppp multilink endpoint ip 209.165.201.20	Overrides or changes the default endpoint discriminator that the system uses when negotiating the use of Multilink PPP with a peer.
Step 5	end Example: Device(config-if)# end	Exits interface configuration mode and returns to privileged EXEC mode.

Configuring Multilink PPP Interleaving and Queueing

Multilink PPP support for interleaving can be configured on virtual templates. To configure interleaving, first configure a virtual template and then configure Multilink PPP and interleaving on the interface or template. These tasks are described in the “Configuring Multilink PPP Interleaving” section.

Note

Fair queueing, which is enabled by default, must remain enabled on the interface.

This section covers the following tasks:

Configuring Multilink PPP Interleaving

Interleaving statistics can be displayed by using the **show interfaces** command, specifying the particular interface on which interleaving is enabled. Interleaving data is displayed only if there are interleaves. For example, the following line shows interleaves:

```
Output queue: 315/64/164974/31191 (size/threshold/drops/interleaves)
```

SUMMARY STEPS

1. **enable**
2. **configure terminal**
3. **interface virtual-template *number***
4. **ppp multilink**
5. **ppp multilink interleave**
6. **ppp multilink fragment delay *milliseconds***
7. **end**

DETAILED STEPS

	Command or Action	Purpose
Step 1	enable Example: Device> enable	Enables privileged EXEC mode. • Enter your password if prompted.
Step 2	configure terminal Example: Device# configure terminal	Enters global configuration mode.
Step 3	interface virtual-template <i>number</i> Example: Device(config)# interface virtual-template 1	Creates a virtual template interface that can be configured and applied dynamically for creating VAIs and enters interface configuration mode.
Step 4	ppp multilink Example: Device(config-if)# ppp multilink	Enables Multilink PPP.
Step 5	ppp multilink interleave Example: Device(config-if)# ppp multilink interleave	Enables the interleaving of packets among fragments of larger packets on a Multilink PPP bundle.

	Command or Action	Purpose
Step 6	<p>ppp multilink fragment delay <i>milliseconds</i></p> <p>Example: Device(config-if)# ppp multilink fragment delay 50</p>	Specifies the maximum size, in units of time, for packet fragments on a Multilink PPP bundle.
Step 7	<p>end</p> <p>Example: Device(config-if)# end</p>	Exits interface configuration mode and returns to privileged EXEC mode.

Disabling PPP Multilink Fragmentation

SUMMARY STEPS

1. **enable**
2. **configure terminal**
3. **interface multilink** *group-number*
4. **ppp multilink fragment disable**
5. **end**

DETAILED STEPS

	Command or Action	Purpose
Step 1	<p>enable</p> <p>Example: Device> enable</p>	<p>Enables privileged EXEC mode.</p> <ul style="list-style-type: none"> • Enter your password if prompted.
Step 2	<p>configure terminal</p> <p>Example: Device# configure terminal</p>	Enters global configuration mode.
Step 3	<p>interface multilink <i>group-number</i></p> <p>Example: Device(config)# interface multilink 10</p>	Assigns a multilink group number and enters interface configuration mode.

	Command or Action	Purpose
Step 4	ppp multilink fragment disable Example: Device(config-if)# ppp multilink fragment disable	Disables PPP multilink fragmentation.
Step 5	end Example: Device(config-if)# end	Exits interface configuration mode and returns to privileged EXEC mode.

Configuring Multilink PPP over Broadband

The following sections provide information about configuring Multilink PPP connections between CPE and PTA devices for MLPoA, MLPoE, MLPoEoA, and MLPoLNS:

Creating a Class Map

SUMMARY STEPS

1. **enable**
2. **configure terminal**
3. **class-map** *class-map-name* [**match-all** | **match-any**]
4. **match ip precedence** *precedence-criteria*
5. **end**

DETAILED STEPS

	Command or Action	Purpose
Step 1	enable Example: Device> enable	Enables privileged EXEC mode. <ul style="list-style-type: none"> • Enter your password if prompted.
Step 2	configure terminal Example: Device# configure terminal	Enters global configuration mode.

	Command or Action	Purpose
Step 3	class-map <i>class-map-name</i> [match-all match-any] Example: Device(config)# class-map ip-prec-1 match-all	Creates a class map to be used for matching traffic with the specified class and enters QoS class-map configuration mode.
Step 4	match ip precedence <i>precedence-criteria</i> Example: Device(config-cmap)# match ip precedence 1	(Optional) Specifies the match criteria in a class map.
Step 5	end Example: Device(config-cmap)# end	Exits QoS class-map configuration mode and returns to privileged EXEC mode.

Creating a Policy Map

SUMMARY STEPS

1. **enable**
2. **configure terminal**
3. **policy-map** *policy-map-name*
4. **class** {*class-name* | **class-default**}
5. **priority percent** *percentage*
6. **shape** {**average** | **peak**} *mean-rate*
7. **service-policy** *policy-map*
8. **end**

DETAILED STEPS

	Command or Action	Purpose
Step 1	enable Example: Device> enable	Enables privileged EXEC mode. <ul style="list-style-type: none"> • Enter your password if prompted.
Step 2	configure terminal Example: Device# configure terminal	Enters global configuration mode.

	Command or Action	Purpose
Step 3	policy-map <i>policy-map-name</i> Example: Device(config)# policy-map mlp-parent-policy-10m	Specifies the name of the policy map to be created and enters QoS policy-map configuration mode.
Step 4	class { <i>class-name</i> class-default } Example: Device(config-pmap)# class ip-prec-1	Specifies the name of the class and enters QoS policy-map class configuration mode. • This class is associated with the class map created in the “Creating a Class Map” section.
Step 5	priority percent <i>percentage</i> Example: Device(config-pmap-c)# priority percent 10	(Optional) Specifies the percentage of the total available bandwidth to be set aside for the priority class.
Step 6	shape { average peak } <i>mean-rate</i> Example: Device(config-pmap-c)# shape average 250000	Shapes traffic to the indicated bit rate according to the algorithm specified.
Step 7	service-policy <i>policy-map</i> Example: Device(config-pmap-c)# service-policy mlp-parent-policy-10m	Attaches a policy map to a class.
Step 8	end Example: Device(config-pmap-c)# end	Exits QoS policy-map class configuration mode and returns to privileged EXEC mode.

Defining a PPP over Ethernet Profile

SUMMARY STEPS

1. **enable**
2. **configure terminal**
3. **bba-group pppoe** {*group-name* | **global**}
4. **virtual-template** *template-number*
5. **end**

DETAILED STEPS

	Command or Action	Purpose
Step 1	enable Example: Device> enable	Enables privileged EXEC mode. <ul style="list-style-type: none"> • Enter your password if prompted.
Step 2	configure terminal Example: Device# configure terminal	Enters global configuration mode.
Step 3	bba-group pppoe <i>{group-name global}</i> Example: Device(config)# bba-group pppoe mlpppoe-bba-group-10m	Defines a PPPoE profile and enters BBA group configuration mode.
Step 4	virtual-template <i>template-number</i> Example: Device(config-bba-group)# virtual-template 18	Specifies the virtual template to be used to clone VAIs for all PPPoE ports that use this PPPoE profile.
Step 5	end Example: Device(config-bba-group)# end	Exits BBA group configuration mode and returns to privileged EXEC mode.

Configuring a Virtual Template Interface

SUMMARY STEPS

1. enable
2. configure terminal
3. interface virtual-template *number*
4. peer default ip address pool [*pool-name*]
5. ppp multilink
6. ppp multilink interleave
7. ppp multilink endpoint string *char-string*
8. ppp multilink retry *seconds*
9. service-policy output *policy-map-name*
10. end

DETAILED STEPS

	Command or Action	Purpose
Step 1	enable Example: Device> enable	Enables privileged EXEC mode. <ul style="list-style-type: none"> • Enter your password if prompted.
Step 2	configure terminal Example: Device# configure terminal	Enters global configuration mode.
Step 3	interface virtual-template <i>number</i> Example: Device(config)# interface virtual-template 1	Creates a virtual template interface that can be configured and applied dynamically for creating VAIs and enters interface configuration mode.
Step 4	peer default ip address pool [<i>pool-name</i>] Example: Device(config-if)# peer default ip address pool MLP-IPv4-Pool	Specifies an IP address from an IP address pool to be returned to a remote peer that is connected to this interface.
Step 5	ppp multilink Example: Device(config-if)# ppp multilink	Enables Multilink PPP.
Step 6	ppp multilink interleave Example: Device(config-if)# ppp multilink interleave	Enables interleaving of packets among fragments of larger packets on a multilink bundle.
Step 7	ppp multilink endpoint string <i>char-string</i> Example: Device(config-if)# ppp multilink endpoint string Dialer2-CPE-MLPoE	Overrides or changes the default endpoint discriminator that the system uses when negotiating the use of Multilink PPP with a peer.
Step 8	ppp multilink retry <i>seconds</i> Example: Device(config-if)# ppp multilink retry 4	Sets the maximum waiting period for a response during PPP negotiation.
Step 9	service-policy output <i>policy-map-name</i> Example: Device(config-if)# service-policy output mlp-parent-10m	Attaches the previously created traffic policy (policy map). <ul style="list-style-type: none"> • The policy map evaluates and applies QoS features for traffic leaving the interface.

	Command or Action	Purpose
Step 10	end Example: Device(config-if)# end	Exits interface configuration mode and returns to privileged EXEC mode.

Configuring Multilink PPP over ATM on the CPE Device

Before configuring Multilink PPP over ATM, you must complete the following tasks:

- Creating a Class Map
- Creating a Policy Map
- Creating a Dialer Interface

This section covers the following tasks:

Configuring Multilink PPP over ATM Using AAL5 MUX Encapsulation

SUMMARY STEPS

1. **enable**
2. **configure terminal**
3. **interface atm** *interface-number*[*.subinterface-number* {**mpls** | **multipoint** | **point-to-point**}]
4. **pvc** *vpi/vci*
5. **vbr-nrt** *output-pcr output-scr output-maxburstsize*
6. **encapsulation aal5mux** *protocol*
7. **dialer pool-number** *number*
8. **end**

DETAILED STEPS

	Command or Action	Purpose
Step 1	enable Example: Device> enable	Enables privileged EXEC mode. • Enter your password if prompted.
Step 2	configure terminal Example: Device# configure terminal	Enters global configuration mode.

	Command or Action	Purpose
Step 3	interface atm <i>interface-number</i> [<i>.subinterface-number</i> { mpls multipoint point-to-point }] Example: Device(config)# interface atm 6/0.20 point-to-point	Specifies the ATM interface for which Multilink PPP must be configured and enters interface configuration mode.
Step 4	pvc <i>vpi/vci</i> Example: Device(config-if)# pvc 20/10	Specifies the encapsulation type on an ATM permanent virtual circuit (PVC) and enters ATM virtual circuit configuration mode.
Step 5	vbr-nrt <i>output-pcr output-scr output-maxburstsize</i> Example: Device(config-if-atm-vc)# vbr-nrt 512 256 20	Configures the variable bit rate-nonreal time (VBR-NRT) and specifies output peak cell rate (PCR), output sustainable cell rate (SCR), and output maximum burst cell size for an ATM PVC.
Step 6	encapsulation aal5mux <i>protocol</i> Example: Device(config-if-atm-vc)# encapsulation aal5mux ppp dialer	Configures the ATM adaptation layer (AAL) and encapsulation type for an ATM virtual circuit (VC).
Step 7	dialer pool-number <i>number</i> Example: Device(config-if-atm-vc)# dialer pool-number 4	Configures a physical interface as a member of a dialer profile dialing pool.
Step 8	end Example: Device(config-if-atm-vc)# end	Exits ATM virtual circuit configuration mode and returns to privileged EXEC mode.

Configuring Multilink PPP over ATM Using AAL5 SNAP Encapsulation

SUMMARY STEPS

1. **enable**
2. **configure terminal**
3. **interface atm** *interface-number*[*.subinterface-number* {**mpls** | **multipoint** | **point-to-point**}]
4. **pvc** *vpil/vci*
5. **vbr-nrt** *output-pcr output-scr output-maxburstsize*
6. **encapsulation aal5snap**
7. **protocol ppp dialer**
8. **dialer pool-number** *number*
9. **end**

DETAILED STEPS

	Command or Action	Purpose
Step 1	enable Example: Device> enable	Enables privileged EXEC mode. • Enter your password if prompted.
Step 2	configure terminal Example: Device# configure terminal	Enters global configuration mode.
Step 3	interface atm <i>interface-number</i> [<i>.subinterface-number</i> { mpls multipoint point-to-point }] Example: Device(config)# interface atm 6/0.20 point-to-point	Specifies the ATM interface for which Multilink PPP must be configured and enters interface configuration mode.
Step 4	pvc <i>vpil/vci</i> Example: Device(config-if)# pvc 20/10	Specifies the encapsulation type on an ATM permanent virtual circuit (PVC) and enters ATM virtual circuit configuration mode.
Step 5	vbr-nrt <i>output-pcr output-scr output-maxburstsize</i> Example: Device(config-if-atm-vc)# vbr-nrt 512 256 20	Configures the variable bit rate-nonreal time (VBR-NRT) and specifies output peak cell rate (PCR), output sustainable cell rate (SCR), and output maximum burst cell size for an ATM PVC.

	Command or Action	Purpose
Step 6	encapsulation aal5snap Example: Device(config-if-atm-vc)# encapsulation aal5snap	Configures the ATM adaptation layer (AAL) and encapsulation type for an ATM virtual circuit (VC).
Step 7	protocol ppp dialer Example: Device(config-if-atm-vc)# protocol ppp dialer	Configures a static map for an ATM PVC.
Step 8	dialer pool-number number Example: Device(config-if-atm-vc)# dialer pool-number 4	Configures a physical interface as a member of a dialer profile dialing pool.
Step 9	end Example: Device(config-if-atm-vc)# end	Exits ATM virtual circuit configuration mode and returns to privileged EXEC mode.

Configuring Multilink PPP over Ethernet over ATM at the CPE

Before You Begin

SUMMARY STEPS

1. enable
2. configure terminal
3. interface atm *interface-number*[*.subinterface-number* {mpls | multipoint | point-to-point}]
4. pvc *vpi/vci*
5. vbr-nrt *output-pcr output-scr output-maxburstsize*
6. pppoe-client dial-pool-number *number*
7. end

DETAILED STEPS

	Command or Action	Purpose
Step 1	enable Example: Device> enable	Enables privileged EXEC mode. <ul style="list-style-type: none"> • Enter your password if prompted.

	Command or Action	Purpose
Step 2	configure terminal Example: Device# configure terminal	Enters global configuration mode.
Step 3	interface atm <i>interface-number</i> [<i>.subinterface-number</i> { mpls multipoint point-to-point }] Example: Device(config)# interface atm 6/0.20 point-to-point	Specifies the ATM interface for which Multilink PPP must be configured and enters interface configuration mode.
Step 4	pvc <i>vpil/vci</i> Example: Device(config-if)# pvc 20/10	Specifies the encapsulation type on an ATM permanent virtual circuit (PVC) and enters ATM virtual circuit configuration mode.
Step 5	vbr-nrt <i>output-pcr output-scr output-maxburstsize</i> Example: Device(config-if-atm-vc)# vbr-nrt 512 256 20	Configures the variable bit rate-nonreal time (VBR-NRT) and specifies output peak cell rate (PCR), output sustainable cell rate (SCR), and output maximum burst cell size for an ATM PVC.
Step 6	pppoe-client dial-pool-number <i>number</i> Example: Device(config-if-atm-vc)# pppoe-client dial-pool-number 6	Configures a PPPoE client.
Step 7	end Example: Device(config-if-atm-vc)# end	Exits ATM virtual circuit configuration mode and returns to privileged EXEC mode.

Configuring Multilink PPP over ATM on the PTA Device

Before configuring Multilink PPP over ATM, you must complete the following tasks:

- Creating a Class Map
- Creating a Policy Map
- Defining a PPP over Ethernet Profile
- Configuring a Virtual Template Interface

This section covers the following tasks:

Configuring Multilink PPP over ATM Using AAL5 MUX Encapsulation

SUMMARY STEPS

1. **enable**
2. **configure terminal**
3. **interface atm** *interface-number*[*.subinterface-number* {**mpls** | **multipoint** | **point-to-point**}]
4. **pvc** *vpilvci*
5. **vbr-nrt** *output-pcr output-scr output-maxburstsize*
6. **encapsulation aal5mux protocol virtual-template** *virtual-template*
7. **end**

DETAILED STEPS

	Command or Action	Purpose
Step 1	enable Example: Device> enable	Enables privileged EXEC mode. • Enter your password if prompted.
Step 2	configure terminal Example: Device# configure terminal	Enters global configuration mode.
Step 3	interface atm <i>interface-number</i> [<i>.subinterface-number</i> { mpls multipoint point-to-point }] Example: Device(config)# interface atm 2/2/1.20 point-to-point	Specifies the ATM interface for which Multilink PPP must be configured and enters interface configuration mode.
Step 4	pvc <i>vpilvci</i> Example: Device(config-if)# pvc 20/10	Specifies the encapsulation type on an ATM PVC and enters ATM virtual circuit configuration mode.
Step 5	vbr-nrt <i>output-pcr output-scr output-maxburstsize</i> Example: Device(config-if-atm-vc)# vbr-nrt 512 256 20	Configures the variable bit rate-nonreal time (VBR-NRT) and specifies output peak cell rate (PCR), output sustainable cell rate (SCR), and output maximum burst cell size for an ATM PVC.
Step 6	encapsulation aal5mux protocol virtual-template <i>virtual-template</i> Example: Device(config-if-atm-vc)# encapsulation aal5mux ppp virtual-template 18	Configures the ATM adaptation layer (AAL) and encapsulation type for an ATM virtual circuit (VC) and assigns the VC to the previously specified virtual template.

	Command or Action	Purpose
Step 7	end Example: Device(config-if-atm-vc)# end	Exits ATM virtual circuit configuration mode returns to privileged EXEC mode.

Configuring Multilink PPP over ATM Using AAL5 SNAP Encapsulation

SUMMARY STEPS

1. **enable**
2. **configure terminal**
3. **interface atm** *interface-number*[*.subinterface-number* {**mpls** | **multipoint** | **point-to-point**}]
4. **pvc** *vpi/vci*
5. **vbr-nrt** *output-pcr output-scr output-maxburstsize*
6. **encapsulation aal5snap**
7. **protocol** *protocol* **virtual-template** *virtual-template*
8. **end**

DETAILED STEPS

	Command or Action	Purpose
Step 1	enable Example: Device> enable	Enables privileged EXEC mode. <ul style="list-style-type: none"> • Enter your password if prompted.
Step 2	configure terminal Example: Device# configure terminal	Enters global configuration mode.
Step 3	interface atm <i>interface-number</i> [<i>.subinterface-number</i> { mpls multipoint point-to-point }] Example: Device(config)# interface atm 2/2/1.22 point-to-point	Specifies the ATM interface for which Multilink PPP must be configured and enters interface configuration mode.
Step 4	pvc <i>vpi/vci</i> Example: Device(config-if)# pvc 20/10	Specifies the encapsulation type on an ATM PVC and enters ATM virtual circuit configuration mode.

	Command or Action	Purpose
Step 5	vbr-nrt <i>output-pcr output-scr output-maxburstsize</i> Example: Device(config-if-atm-vc)# vbr-nrt 512 256 20	Configures the variable bit rate-nonreal time (VBR-NRT) and specifies output peak cell rate (PCR), output sustainable cell rate (SCR), and output maximum burst cell size for an ATM PVC.
Step 6	encapsulation aal5snap Example: Device(config-if-atm-vc)# encapsulation aal5snap	Configures the ATM adaptation layer (AAL) and encapsulation type for an ATM virtual circuit (VC).
Step 7	protocol protocol virtual-template <i>virtual-template</i> Example: Device(config-if-atm-vc)# protocol ppp virtual-template 18	Specifies parameters that PPPoA sessions use.
Step 8	end Example: Device(config-if-atm-vc)# end	Exits ATM virtual circuit configuration mode and returns to privileged EXEC mode.

Configuring Multilink PPP over Ethernet over ATM on the PTA Device

Before configuring Multilink PPP over Ethernet over ATM, you must complete the following tasks:

- Creating a Class Map
- Creating a Policy Map
- Defining a PPP over Ethernet Profile
- Configuring a Virtual Template Interface

This section covers the following tasks:

Configuring a Virtual Circuit Class

Before configuring MLPoEoA, you must create and configure a virtual circuit (VC) class.

SUMMARY STEPS

1. **enable**
2. **configure terminal**
3. **vc-class atm *name***
4. **protocol pppoe [*group group-name*]**
5. **vbr-nrt *output-pcr output-scr output-maxburstsize***
6. **encapsulation aal5snap**
7. **create-on demand**
8. **idle-timeout *minutes***
9. **end**

DETAILED STEPS

	Command or Action	Purpose
Step 1	enable Example: Device> enable	Enables privileged EXEC mode. • Enter your password if prompted.
Step 2	configure terminal Example: Device# configure terminal	Enters global configuration mode.
Step 3	vc-class atm <i>name</i> Example: Device(config)# vc-class atm mlpoeoa-vc-class	Creates a VC class and enters VC-class configuration mode.
Step 4	protocol pppoe [<i>group group-name</i>] Example: Device(config-vc-class)# protocol pppoe group mlpoeoa-bba-group	Enables PPP over Ethernet (PPPoE) sessions to be established on permanent virtual circuits (PVCs).
Step 5	vbr-nrt <i>output-pcr output-scr output-maxburstsize</i> Example: Device(config-vc-class)# vbr-nrt 512 256 20	Configures the variable bit rate-nonreal time (VBR-NRT) and specifies the output peak cell rate (PCR), output sustainable cell rate (SCR), and output maximum burst cell size for an ATM PVC.
Step 6	encapsulation aal5snap Example: Device(config-vc-class)# encapsulation aal5snap	Configures the ATM adaptation layer (AAL) and encapsulation type for an ATM VC.

	Command or Action	Purpose
Step 7	create-on demand Example: Device (config-vc-class)# create-on demand	Configures ATM PVC autoprovisioning, which enables a PVC or range of PVCs to be created automatically on demand.
Step 8	idle-timeout <i>minutes</i> Example: Device(config-vc-class)# idle-timeout 10	Sets a time to keep the session alive in the absence of any data traffic.
Step 9	end Example: Device (config-vc-class)# end	Exits VC-class configuration mode and returns to privileged EXEC mode.

Configuring Multilink PPP over Ethernet over ATM Using AAL5 SNAP Encapsulation

SUMMARY STEPS

1. **enable**
2. **configure terminal**
3. **interface atm** *interface-number*[*.subinterface-number* {**mpls** | **multipoint** | **point-to-point**}]
4. **pvc** *vpilvci*
5. **class-vc** *name*
6. **vbr-nrt** *output-pcr output-scr output-maxburstsize*
7. **end**

DETAILED STEPS

	Command or Action	Purpose
Step 1	enable Example: Device> enable	Enables privileged EXEC mode. <ul style="list-style-type: none"> • Enter your password if prompted.
Step 2	configure terminal Example: Device# configure terminal	Enters global configuration mode.

	Command or Action	Purpose
Step 3	interface atm <i>interface-number</i> [<i>.subinterface-number</i> { mpls multipoint point-to-point }] Example: Router (config)# interface atm 2/2/1.24 point-to-point	Specifies the ATM interface for which Multilink PPP must be configured and enters interface configuration mode.
Step 4	pvc <i>vpi/vci</i> Example: Device(config-if)# pvc 20/10	Specifies the encapsulation type on an ATM permanent virtual circuit (PVC) and enters ATM virtual circuit configuration mode.
Step 5	class-vc <i>name</i> Example: Device(config-if-atm-vc)# class-vc mlpppoeoa-vc-class	Assigns a virtual circuit (VC) class to an ATM PVC.
Step 6	vbr-nrt <i>output-pcr output-scr output-maxburstsize</i> Example: Device(config-if-atm-vc)# vbr-nrt 512 256 20	Configures the variable bit rate-nonreal time (VBR-NRT) and specifies the output peak cell rate (PCR), output sustainable cell rate (SCR), and output maximum burst cell size for an ATM PVC.
Step 7	end Example: Device(config-if-atm-vc)# end	Exits ATM virtual circuit configuration mode and returns to privileged EXEC mode.

Configuring Multilink PPP over LNS

Configuring an LNS Device to Initiate and Receive L2TP Traffic

Before performing this task, you must configure the virtual template interface as described in the “Configuring a Virtual Template Interface” section.

SUMMARY STEPS

1. **enable**
2. **configure terminal**
3. **vpdn enable**
4. **vpdn-group** *group-name*
5. **accept-dialin**
6. **protocol l2tp**
7. **virtual-template** *template-number*
8. **exit**
9. **terminate-from hostname** *hostname*
10. **lcp renegotiation** {*always* | *on-mismatch*}
11. **no l2tp authentication**
12. **end**

DETAILED STEPS

	Command or Action	Purpose
Step 1	enable Example: Device> enable	Enables privileged EXEC mode. • Enter your password if prompted.
Step 2	configure terminal Example: Device# configure terminal	Enters global configuration mode.
Step 3	vpdn enable Example: Device(config)# vpdn enable	Enables virtual private dialup network (VPDN) on the device. • The device looks for tunnel definitions in a local database and on a remote authorization server (home gateway) if one is present.
Step 4	vpdn-group <i>group-name</i> Example: Device(config)# vpdn-group group1	Defines a local group name for which you can assign other VPDN variables and enters VPDN group configuration mode.
Step 5	accept-dialin Example: Device(config-vpdn)# accept-dialin	Configures the LNS device to accept tunneled PPP connections from the LAC device, creates an accept-dialin VPDN subgroup, and enters VPDN accept-dialin group configuration mode.

	Command or Action	Purpose
Step 6	protocol l2tp Example: Device(config-vpdn-acc-in)# protocol l2tp	Specifies the Layer 2 Tunnel Protocol (L2TP).
Step 7	virtual-template <i>template-number</i> Example: Device(config-vpdn-acc-in)# virtual-template 18	Specifies the virtual template to be used to clone virtual access interfaces (VAIs).
Step 8	exit Example: Device(config-vpdn-acc-in)# exit	Returns to VPDN group configuration mode.
Step 9	terminate-from hostname <i>hostname</i> Example: Device(config-vpdn)# terminate-from hostname LAC3	Specifies the hostname of the remote LAC device that will be required when accepting a VPDN tunnel.
Step 10	lcp renegotiation {always on-mismatch} Example: Device(config-vpdn)# lcp renegotiation always	Allows the LNS device to renegotiate the PPP Link Control Protocol (LCP).
Step 11	no l2tp authentication Example: Device(config-vpdn)# no l2tp authentication	Disables L2TP tunnel authentication.
Step 12	end Example: Device(config-vpdn)# end	Returns to privileged EXEC mode.

Configuring a LAC Device to Initiate and Receive L2TP Traffic

SUMMARY STEPS

1. **enable**
2. **configure terminal**
3. **vpdn enable**
4. **vpdn-group** *group-name*
5. **request-dialin**
6. **protocol l2tp**
7. **exit**
8. **initiate-to ip** *ip-address* [**priority** *priority-number*]
9. **local name** *hostname*
10. **no l2tp authentication**
11. **end**

DETAILED STEPS

	Command or Action	Purpose
Step 1	enable Example: Device> enable	Enables privileged EXEC mode. • Enter your password if prompted.
Step 2	configure terminal Example: Device# configure terminal	Enters global configuration mode.
Step 3	vpdn enable Example: Router(config)# vpdn enable	Enables virtual private dialup network (VPDN) on the device.
Step 4	vpdn-group <i>group-name</i> Example: Device(config)# vpdn-group group1	Defines a local group name for which you can assign other VPDN variables and enters VPDN group configuration mode.
Step 5	request-dialin Example: Device(config-vpdn)# request-dialin	Enables the LAC device to request Layer 2 Tunneling Protocol (L2TP) tunnels and enters VPDN request-dialin group configuration mode.

	Command or Action	Purpose
Step 6	protocol l2tp Example: Device(config-vpdn-req-in)# protocol l2tp	Specifies the L2TP protocol.
Step 7	exit Example: Device(config-vpdn-req-in)# exit	Returns to VPDN group configuration mode.
Step 8	initiate-to ip <i>ip-address</i> [priority <i>priority-number</i>] Example: Device(config-vpdn)# initiate-to ip 10.0.0.4	Specifies the LNS IP address and optionally, the priority of the IP address (1 is the highest).
Step 9	local name <i>hostname</i> Example: Device(config-vpdn)# local name LAC3	Specifies a local hostname that the tunnel will use to identify itself.
Step 10	no l2tp authentication Example: Device(config-vpdn)# no l2tp authentication	Disables L2TP tunnel authentication.
Step 11	end Example: Device(config-vpdn)# end	Exits VPDN group configuration mode and returns to privileged EXEC mode.

Configuring Multilink PPP over Serial Interfaces

To configure Multilink PPP over serial interfaces, configure serial interfaces to support PPP encapsulation and Multilink PPP. Repeat the steps below for as many serial interfaces as required.

SUMMARY STEPS

1. **enable**
2. **configure terminal**
3. **interface serial** *number*
4. **no ip address**
5. **encapsulation ppp**
6. **ppp multilink**
7. **end**

DETAILED STEPS

	Command or Action	Purpose
Step 1	enable Example: Device> enable	Enables privileged EXEC mode. • Enter your password if prompted.
Step 2	configure terminal Example: Device# configure terminal	Enters global configuration mode.
Step 3	interface serial <i>number</i> Example: Device(config)# interface serial 1	Specifies an asynchronous interface and enters interface configuration mode.
Step 4	no ip address Example: Device(config-if)# no ip address	Removes any specified IP address.
Step 5	encapsulation ppp Example: Device(config-if)# encapsulation ppp	Enables PPP encapsulation.
Step 6	ppp multilink Example: Device(config-if)# ppp multilink	Enables Multilink PPP.
Step 7	end Example: Device(config-if)# end	Exits interface configuration mode and returns to privileged EXEC mode.

Configuration Examples for Multilink PPP Connections for Broadband and Serial Topologies

Example: Configuring Multilink PPP

Multilink PPP provides characteristics most similar to hardware inverse multiplexers with good manageability and Layer 3 services support. The following example shows the configuration of Multilink PPP with traffic shaping and QoS. In this example, two bundles with four links each are configured between two devices. The **ppp chap hostname** command entries are required for originating and terminating multiple bundles on a single pair of devices.

```

controller T3 0/3/1
 framing c-bit
 cablelength 224
 t1 1 channel-group 0 timeslots 1-24
 t1 2 channel-group 0 timeslots 1-24
 t1 3 channel-group 0 timeslots 1-24
 t1 4 channel-group 0 timeslots 1-24
 t1 5 channel-group 0 timeslots 1-24
 t1 6 channel-group 0 timeslots 1-24
 t1 7 channel-group 0 timeslots 1-24
 t1 8 channel-group 0 timeslots 1-24
 !
class-map match-all DETERMINISTICOUT
 match ip precedence 3
class-map match-all VOICEVIDEOCONTROLOUT
 match ip precedence 2
class-map match-all VOICEOUT
 match ip precedence 1
class-map match-all ROUTINGPROTOCOLS
 match ip precedence 5
class-map match-all CONTROLLEDLOADOUT
 match ip precedence 4
 !
policy-map QOS304QCHILD
 class VOICEOUT
  priority level 1
  police cir percent 30
 class VOICEVIDEOCONTROLOUT
  priority level 2
  police cir percent 5
 class DETERMINISTICOUT
  bandwidth remaining ratio 20
 class CONTROLLEDLOADOUT
  bandwidth remaining ratio 18
 class ROUTINGPROTOCOLS
  bandwidth remaining ratio 4
 class class-default
  bandwidth remaining ratio 22
policy-map ASRMLP6MBPARENT
 class class-default
  shape average percent 98
  service-policy QOS304QCHILD
 !
interface multilink 1
 ip address 192.168.1.1 255.255.255.0
 ppp chap hostname multilink_name-1
 ppp multilink
 ppp multilink group 1
 service-policy output ASRMLP6MBPARENT
 !
interface multilink 2
 ip address 192.168.2.1 255.255.255.0

```

Example: Configuring Multilink PPP

```

ppp chap hostname multilink_name-2
ppp multilink
ppp multilink group 2
service-policy output ASRMLP6MBPARENT
!
interface serial 0/3/1/1:0
no ip address
encapsulation ppp
no keepalive
ppp chap hostname multilink_name-1
ppp multilink
ppp multilink group 1
!
interface serial 0/3/1/2:0
no ip address
encapsulation ppp
no keepalive
ppp chap hostname multilink_name-1
ppp multilink
ppp multilink group 1
!
interface serial 0/3/1/3:0
no ip address
encapsulation ppp
no keepalive
ppp chap hostname multilink_name-1
ppp multilink
ppp multilink group 1
!
interface serial 0/3/1/4:0
no ip address
encapsulation ppp
no keepalive
ppp chap hostname multilink_name-1
ppp multilink
ppp multilink group 1
!
interface serial 0/3/1/5:0
no ip address
encapsulation ppp
no keepalive
ppp chap hostname multilink_name-2
ppp multilink
ppp multilink group 2
!
interface serial 0/3/1/6:0
no ip address
encapsulation ppp
no keepalive
ppp chap hostname multilink_name-2
ppp multilink
ppp multilink group 2
!
interface serial 0/3/1/7:0
no ip address
encapsulation ppp
no keepalive
ppp chap hostname multilink_name-2
ppp multilink
ppp multilink group 2
!
interface serial 0/3/1/8:0
no ip address
encapsulation ppp
no keepalive
ppp chap hostname multilink_name-2
ppp multilink
ppp multilink group 2
!

```

Example: Configuring Multilink PPP over ATM on the PTA Device

Example: Configuring Multilink PPP over ATM Using AAL5 MUX Encapsulation

The following example shows how to configure Multilink PPP over ATM (MLPoA) with AAL5 MUX encapsulation on the PTA device:

```
class-map match-all ip-prec-1
  match ip precedence 1
policy-map mlp-child-lfi-policy
  class ip-prec-1
    priority percent 10
policy-map mlp-parent-250K
  class class-default
    shape average 250000
  service-policy mlp-child-lfi-policy
policy-map mlp-parent-10M
  class class-default
    shape average 10000000
  service-policy mlp-child-lfi-policy
interface virtual-template 18
  description MLPoEoA/MLPoA aal5mux/aal5snap (single-link bundle) Virtual Template
  ip address negotiated
  peer default ip address pool MLP-IPv4-Pool
  ppp max-failure 30
  ppp chap password 0 password1
  ppp multilink
  ppp multilink interleave
  ppp multilink endpoint magic-number
  ppp timeout retry 4
  service-policy output mlp-parent-250K
  bba-group pppoe mlpoeoa-bba-group-250K
  virtual-template 18
  ip local pool MLP-IPv4-Pool 209.165.201.2 209.165.201.10
  ip forward-protocol nd
  no ip http server
  no ip http secure-server
  ip route 10.0.0.0 255.0.0.0 172.16.0.1
  ip route 192.168.0.1 255.255.255.255 198.51.100.1
  ip route 192.168.0.2 255.255.255.255 198.51.100.2
  ip route 192.168.0.3 255.255.255.255 198.51.100.3
  ip route 192.168.0.4 255.255.255.255 198.51.100.4
  ip route 192.168.0.5 255.255.255.255 198.51.100.5
  ip route 192.168.0.6 255.255.255.255 198.51.100.6
  ip route vrf Mgmt-intf 10.0.0.0 255.0.0.0 192.168.0.1
  ip route vrf Mgmt-intf 172.16.0.0 255.0.0.0 192.168.0.1
  ip route vrf Mgmt-intf 209.165.202.128 255.0.0.0 192.168.0.1
  ip route vrf Mgmt-intf 192.168.0.0 255.255.240.0 192.168.0.1
interface atm 2/2/1.20 point-to-point
  description MLPoA aal5mux (Single-Link Bundles) Session (PTA Mode)
  no atm enable-ilmi-trap
  pvc 20/10
    vbr-nrt 512 256 1
    encapsulation aal5mux ppp Virtual-Template18
```

Example: Configuring Multilink PPP over ATM Using AAL5 SNAP Encapsulation

The following example shows how to configure Multilink PPP over ATM (MLPoA) with AAL5 SNAP encapsulation on the PTA device:

```
class-map match-all ip-prec-1
  match ip precedence 1
policy-map mlp-child-lfi-policy
  class ip-prec-1
    priority percent 10
```

Example: Configuring Multilink PPP over Ethernet over ATM on the PTA Device

```

policy-map mlp-parent-250K
  class class-default
    shape average 250000
    service-policy mlp-child-lfi-policy
policy-map mlp-parent-10M
  class class-default
    shape average 10000000
    service-policy mlp-child-lfi-policy
interface virtual-template 18
  description MLPoEoA/MLPoA aal5mux/aal5snap (single-link bundle) Virtual Template
  ip address negotiated
  peer default ip address pool MLP-IPv4-Pool
  ppp max-failure 30
  ppp chap password 0 password1
  ppp multilink
  ppp multilink interleave
  ppp multilink endpoint magic-number
  ppp timeout retry 4
  service-policy output mlp-parent-250K
bba-group pppoe mlpoeoa-bba-group-250K
  virtual-template 18
ip local pool MLP-IPv4-Pool 209.165.201.2 209.165.201.10
ip forward-protocol nd
no ip http server
no ip http secure-server
ip route 10.0.0.0 255.0.0.0 172.16.0.1
ip route 192.168.0.1 255.255.255.255 198.51.100.1
ip route 192.168.0.2 255.255.255.255 198.51.100.2
ip route 192.168.0.3 255.255.255.255 198.51.100.3
ip route 192.168.0.4 255.255.255.255 198.51.100.4
ip route 192.168.0.5 255.255.255.255 198.51.100.5
ip route 192.168.0.6 255.255.255.255 198.51.100.6
ip route vrf Mgmt-intf 10.0.0.0 255.0.0.0 192.168.0.1
ip route vrf Mgmt-intf 172.16.0.0 255.0.0.0 192.168.0.1
ip route vrf Mgmt-intf 209.165.202.128 255.0.0.0 192.168.0.1
ip route vrf Mgmt-intf 192.168.0.0 255.255.240.0 192.168.0.1
interface atm 2/2/1.22 point-to-point
  description MLPoA aal5snap (Single-Link Bundles) Session (PTA Mode)
  no atm enable-ilmi-trap
  pvc 20/14
    vbr-nrt 512 256 20
    encapsulation aal5snap
    protocol ppp Virtual-Template18

```

Example: Configuring Multilink PPP over Ethernet over ATM on the PTA Device

The following example shows how to configure Multilink PPP over Ethernet over ATM (MLPoEoA) with AAL5 SNAP encapsulation on the PTA device:

```

class-map match-all ip-prec-1
  match ip precedence 1
policy-map mlp-child-lfi-policy
  class ip-prec-1
    priority percent 10
policy-map mlp-parent-250K
  class class-default
    shape average 250000
    service-policy mlp-child-lfi-policy
policy-map mlp-parent-10M
  class class-default
    shape average 10000000
    service-policy mlp-child-lfi-policy
interface virtual-template 18
  description MLPoEoA/MLPoA aal5mux/aal5snap (single-link bundle) Virtual Template
  ip address negotiated
  peer default ip address pool MLP-IPv4-Pool
  ppp max-failure 30
  ppp chap password 0 password1
  ppp multilink
  ppp multilink interleave

```

```

ppp multilink endpoint magic-number
ppp timeout retry 4
service-policy output mlp-parent-250K
bba-group pppoe mlpoeoa-bba-group-250K
virtual-template 18
vc-class atm mlpoeoa-vc-class-250K
protocol pppoe group mlpoeoa-bba-group-250K
vbr-nrt 512 256 20
encapsulation aal5snap
create on-demand
idle-timeout 30
ip local pool MLP-IPv4-Pool 209.165.201.2 209.165.201.10
ip forward-protocol nd
no ip http server
no ip http secure-server
ip route 10.0.0.0 255.0.0.0 172.16.0.1
ip route 192.168.0.1 255.255.255.255 198.51.100.1
ip route 192.168.0.2 255.255.255.255 198.51.100.2
ip route 192.168.0.3 255.255.255.255 198.51.100.3
ip route 192.168.0.4 255.255.255.255 198.51.100.4
ip route 192.168.0.5 255.255.255.255 198.51.100.5
ip route 192.168.0.6 255.255.255.255 198.51.100.6
ip route vrf Mgmt-intf 10.0.0.0 255.0.0.0 192.168.0.1
ip route vrf Mgmt-intf 172.16.0.0 255.0.0.0 192.168.0.1
ip route vrf Mgmt-intf 209.165.202.128 255.0.0.0 192.168.0.1
ip route vrf Mgmt-intf 192.168.0.0 255.255.240.0 192.168.0.1
interface atm 2/2/1.24 point-to-point
description MLPoEoA aal5snap (Single-Link Bundles) Session (PTA Mode)
no atm enable-ilmi-trap
pvc 23/32
class-vc mlpoeoa-vc-class-250K
vbr-nrt 512 256 20

```

Example: Configuring Multilink PPP over LNS

Example: Configuring an LNS Device to Initiate and Receive L2TP Traffic

The following example shows how to set up a tunnel on the Gigabit Ethernet interface on which virtual private dialup network (VPDN) member links are negotiated and added to the Multilink PPP bundle that is cloned from virtual template 500:

```

aaa new-model
!
!
aaa authentication ppp default local
aaa authentication ppp TESTME group radius
aaa authorization network default local
aaa authorization network TESTME group radius
!
aaa session-id common
buffers small perm 15000
buffers mid perm 12000
buffers big perm 8000
!
vpdn enable
!
vpdn-group LNS_1
accept-dialin
protocol l2tp
virtual-template 500
terminate-from hostname LAC1-1
local name LNS1-1
lcp renegotiation always
l2tp tunnel receive-window 100
L2tp tunnel password 0 password1
l2tp tunnel nosession-timeout 30
l2tp tunnel retransmit retries 7

```

Example: Configuring Multilink PPP over LNS

```

l2tp tunnel retransmit timeout min 2
l2tp tunnel retransmit timeout max 8
!
!
interface GigabitEthernet 2/0/0
ip address 209.165.202.140 255.255.255.0
negotiation auto
hold-queue 4096 in
!
!
interface virtual-template 500
ip unnumbered Loopback1
peer default ip address pool pool-1
ppp mtu adaptive
ppp timeout authentication 100
ppp max-configure 110
ppp max-failure 100
ppp timeout retry 5
keepalive 30
ppp authentication pap TESTME
ppp authorization TESTME
ppp multilink
!
ip local pool pool-1 209.165.201.3 209.165.201.30
radius-server host 10.0.0.10 auth-port 1645 acct-port 1646 key password1
radius-server retransmit 0

```

Example: Configuring a LAC Device to Initiate and Receive L2TP Traffic

The following example shows how to set up a tunnel on a LAC device to initiate and receive traffic:

```

vpdn enable
vpdn search-order domain
!
vpdn-group cisco-1.com
request-dialin
protocol l2tp
domain cisco-1.com
initiate-to ip 10.0.0.4
local name LAC1
no l2tp tunnel authentication
!
vpdn-group cisco-2.com
request-dialin
protocol l2tp
domain cisco-2.com
initiate-to ip 10.0.0.4
local name LAC2
no l2tp tunnel authentication
!
vpdn-group cisco-3.com
request-dialin
protocol l2tp
domain cisco-3.com
initiate-to ip 10.0.0.4
local name LAC3
no l2tp tunnel authentication
!
vpdn-group cisco-4.com
request-dialin
protocol l2tp
domain cisco-4.com
initiate-to ip 10.0.0.4
local name LAC4
no l2tp tunnel authentication
!
bba-group pppoe cpe-lac-lns-group
virtual-template 99
!
interface GigabitEthernet 0/0/0
description GE connection to cpp-rtp-7200-41 0/1 (PTA-to-CPE)

```



```

no ip address
negotiation auto
!
interface GigabitEthernet 0/0/0.23
description PPPoEoVLAN-to-PPPoLNS (non-MLP) Sessions CPE-LAC-LNS
encapsulation dot1Q 23
pppoe enable group cpe-lac-lns-group
!
interface GigabitEthernet 0/0/0.24
description PPPoEoQinQ-to-PPPoLNS (non-MLP) Sessions CPE-LAC-LNS
encapsulation dot1Q 24 second-dot1q 240
pppoe enable group cpe-lac-lns-group
!
interface GigabitEthernet 0/2/0
description GE connection to cpp-rtp-7200-41 0/2 (PTA-to-CPE)
no ip address
negotiation auto
!
interface GigabitEthernet 0/2/0.23
description MLPPPoEoVLAN-to-MLPPPoLNS (Single Link Bundles) Sessions CPE-LAC-LNS
encapsulation dot1Q 23
pppoe enable group cpe-lac-lns-group
!
interface GigabitEthernet 0/2/0.24
description MLPPPoEoQinQ-to-MLPPPoLNS (Single Link Bundles) Sessions CPE-LAC-LNS
encapsulation dot1Q 24 second-dot1q 240
pppoe enable group cpe-lac-lns-group
!
interface TenGigabitEthernet 1/0/0
description TenGig connection to cpp-rtp-mcp6ru-01 1/0/0 (LAC-to-LNS)
ip address 10.0.0.3 255.255.0.0
!
interface virtual-template 99
description VT for PPPoE/MLPPPoE sessions from CPE being forwarded to LNS CPE-LAC-LNS
no ip address
no peer default ip address
ppp mtu adaptive
ppp authentication chap pap

```

Example: Configuring Multilink PPP over Serial Interfaces

The figure below shows a typical inverse multiplexing application using two Cisco routers and Multilink PPP over four T1 lines.

Figure 7: Inverse Multiplexing Application Using Multilink PPP

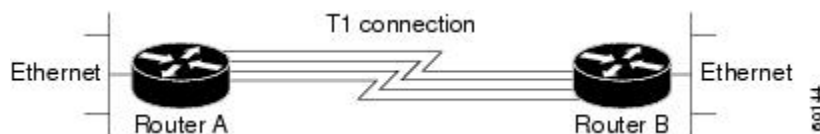

The example below shows the configuration commands that are used to create the inverse multiplexing application.

Router A Configuration

```

hostname RouterA
!
!
username RouterB password passwordA
ip subnet-zero
multilink virtual-template 1
!
interface virtual-template 1

```

Example: Configuring Multilink PPP over Serial Interfaces

```

ip unnumbered Ethernet0
ppp authentication chap
ppp multilink
!
interface serial 0
no ip address
encapsulation ppp
no fair-queue
ppp multilink
!
interface serial 1
no ip address
encapsulation ppp
no fair-queue
ppp multilink
!
interface serial 2
no ip address
encapsulation ppp
no fair-queue
ppp multilink
!
interface serial 3
no ip address
encapsulation ppp
no fair-queue
ppp multilink
!
interface GigabitEthernet 0/0/0
ip address 10.17.1.254 255.255.255.0
!
router rip
network 10.0.0.0
!
end

```

Router B Configuration

```

hostname RouterB
!
!
username RouterB password passwordA
ip subnet-zero
multilink virtual-template 1
!
interface virtual-template 1
ip unnumbered Ethernet0
ppp authentication chap
ppp multilink
!
interface serial 0
no ip address
encapsulation ppp
no fair-queue
ppp multilink
!
interface serial 1
no ip address
encapsulation ppp
no fair-queue
ppp multilink
!
interface serial 2
no ip address
encapsulation ppp
no fair-queue
ppp multilink
!
interface serial 3
no ip address
encapsulation ppp
no fair-queue

```

```

ppp multilink
!
interface GigabitEthernet 0/0/0
 ip address 10.17.2.254 255.255.255.0
!
router rip
 network 10.0.0.0
!
end

```

Additional References for Multilink PPP Connections for Broadband and Serial Topologies

Related Documents

Related Topic	Document Title
Cisco IOS commands	Cisco IOS Master Command List, All Releases
PPP commands	Dial Technologies Command Reference
Broadband configuration tasks	<i>Broadband and DSL Configuration Guide</i>
Multilink PPP	<i>Multilink PPP Feature Functionality on the ASR 1000 Series Aggregation Services Router</i>

Standards and RFCs

Standard/RFC	Title
RFC 1990	<i>The PPP Multilink Protocol (MP)</i>
RFC 2686	<i>The Multi-Class Extension to Multi-Link PPP</i>

MIBs

MIB	MIBs Link
None	To locate and download MIBs for selected platforms, Cisco software releases, and feature sets, use Cisco MIB Locator found at the following URL: http://www.cisco.com/go/mibs

Technical Assistance

Description	Link
The Cisco Support and Documentation website provides online resources to download documentation, software, and tools. Use these resources to install and configure the software and to troubleshoot and resolve technical issues with Cisco products and technologies. Access to most tools on the Cisco Support and Documentation website requires a Cisco.com user ID and password.	http://www.cisco.com/cisco/web/support/index.html

Feature Information for Multilink PPP Connections for Broadband and Serial Topologies

The following table provides release information about the feature or features described in this module. This table lists only the software release that introduced support for a given feature in a given software release train. Unless noted otherwise, subsequent releases of that software release train also support that feature.

Use Cisco Feature Navigator to find information about platform support and Cisco software image support. To access Cisco Feature Navigator, go to www.cisco.com/go/cfn. An account on Cisco.com is not required.

Table 4: Feature Information for Multilink PPP Connections for Broadband and Serial Topologies

Feature Name	Releases	Feature Information
MLPoA and MLPoEoA—PTA	Cisco IOS XE Release 3.4S	<p>Configuring Multilink PPP over broadband includes configuring Multilink PPP over ATM (MLPoA), Multilink PPP over Ethernet (MLPoE), Multilink PPP over Ethernet over ATM (MLPoEoA), Multilink PPP over Queue-in-Queue (MLPoQinQ), and Multilink PPP over VLAN (MLPoVLAN).</p> <p>Note For Multilink PPP over Serial, Multilink PPP over Ethernet, and Multilink PPP over LNS, see the Release Notes specific to your platform and release.</p> <p>This feature also provides support for Link Fragmentation and Interleaving (LFI) to meet additional needs of service providers to manage the latency of their delay-sensitive voice, video, and interactive application traffic on slower broadband links.</p>



CHAPTER

4

MLPoE at PTA

The Multilink PPP over Ethernet (MLPoE) at PPP Termination and Aggregation (PTA) feature allows customer premises equipment (CPE) and PTA devices to interleave high-priority and low-latency packets (PPP encapsulated) between Multilink PPP fragments of lower-priority and higher-latency packets.

- [Finding Feature Information, page 73](#)
- [Prerequisites for MLPoE at PTA, page 73](#)
- [Restrictions for MLPoE at PTA, page 74](#)
- [Information About MLPoE at PTA , page 74](#)
- [How to Configure MLPoE at PTA, page 75](#)
- [Configuration Examples for MLPoE at PTA, page 78](#)
- [Additional References for MLPoE at PTA, page 80](#)
- [Feature Information for MLPoE at PTA, page 81](#)

Finding Feature Information

Your software release may not support all the features documented in this module. For the latest caveats and feature information, see [Bug Search Tool](#) and the release notes for your platform and software release. To find information about the features documented in this module, and to see a list of the releases in which each feature is supported, see the feature information table.

Use Cisco Feature Navigator to find information about platform support and Cisco software image support. To access Cisco Feature Navigator, go to www.cisco.com/go/cfn. An account on Cisco.com is not required.

Prerequisites for MLPoE at PTA

Before configuring Multilink PPP over Ethernet (MLPoE) at PPP termination and aggregation (PTA), you must complete the following tasks:

- Creating a Class Map
- Creating a Policy Map

- Defining a PPP over Ethernet Profile
- Configuring a Virtual Template Interface

For more information see Configuring Multilink PPP over Broadband section.

Restrictions for MLPoE at PTA

- In-Service Software Upgrade (ISSU) and Stateful Switchover (SSO) for Broadband MLP sessions are not supported.
- Multilink PPP over Ethernet (MLPoE) using EtherChannel is not supported.
- Cisco IOS XE software supports a maximum of 4000 member links using MLPoE.
- For MLP virtual access bundles, the default Layer 3 (that is IP, IPv6) maximum transmission unit (MTU) value is 1500. When the member link of the MLPPP bundle are Ethernet-like in MLPoEoE, MLPoEoVLAN, and MLPoEoQinQ, the MTU value of 1500 can cause an issue when sending IP packets close to this size. For example, when a 1500-byte IP packet is sent by a device over MLPoEoE, the actual packet size transmitted is 1522: 14 (Ethernet header) + 8 (PPPoE header) + 6 (MLP header) + 1500 (IP) = 1528. A device enforcing MRU might drop the incoming packet as a "giant" because it exceeds the default expected maximum packet size. The 1500-byte MTU size does not take into account any PPPoE or MLP header overhead and, hence, causes packets greater than 1492 bytes to be dropped by the peer. To address this issue, do one of the following:
 - Lower the MTU on the MLP bundle to 1492.
 - Increase the MTU on the Ethernet interface to 9216. Also, increase the MTU on the bundle by adjusting the MTU of the virtual template to 1508.
- Member Link Session bandwidth—For MLPoE PPP termination and aggregation (PTA) variations, by default the bandwidth of the member link session is that of the parent interface. If a bandwidth statement is added to the virtual template, the member link session uses that bandwidth as the member link session bandwidth. This bandwidth is in turn communicated to MLPPP in the bundle member link aggregate data rate bandwidth calculation.
- If the Digital Subscriber Line Access Multiplexer (DSLAM) between the CPE and PTA communicates the link rate via the PPPoE dsl-sync-rate tags (Actual Data-Rate Downstream [0x82/130d] tag), this data is passed by the PTA device to the RADIUS server but is not acted upon by the ASR 1000 device. The data rate of the session remains as described above in the previous bullet. Note that this behavior is specific to PTA mode; LAC/LNS behaves differently. Use the **dsl line info forwarding** command on the LAC to transport the LAC access speed to the LNS.

Information About MLPoE at PTA

MLPoE at PTA Overview

Single-link PPP over Ethernet and Multilink PPP over Ethernet (MLPoE) bundles support upstream and downstream link fragmentation and interleaving (LFI). Upstream refers to the traffic from the customer premises equipment (CPE) and downstream refers to the traffic to the CPE. The receiving device (CPE for

downstream and PPP termination and aggregation [PTA] for upstream) reassembles fragmented, nonpriority packets. To reduce any delay in forwarding high-priority packets, the receiving device processes high-priority PPP packets as soon as they arrive.

The figure below shows a sample MLPoE network with LFI.

Figure 8: MLPoE DSL Network with LFI

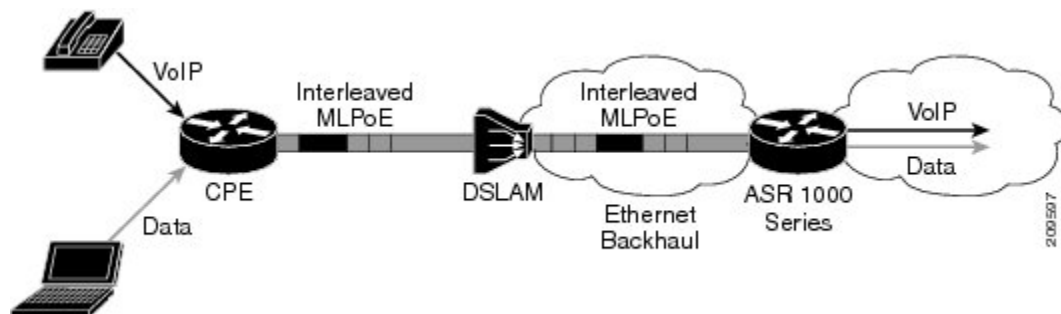

PPP over Ethernet (PPPoE) sessions in MLPoE on a PTA device are handled as follows:

- All supported variations of PPPoE, such as PPP over Ethernet over ATM (PPPoEoA), PPP over Ethernet over Ethernet (PPPoEoE), PPP over Ethernet over Queue-in-Queue (PPPoEoQinQ), and PPP over Ethernet over VLAN (PPPoEoVLAN), can be used as member links for MLPoE bundles.
- Termination of an MLPoE bundle in a virtual routing and forwarding (VRF) block is similar to terminating a PPPoE session in a VRF instance.
- MLPoE bundles are distinguished by the username that was used to authenticate the PPPoE member link session.

How to Configure MLPoE at PTA

Configuring MLPoE at PTA

SUMMARY STEPS

1. **enable**
2. **configure terminal**
3. **interface** *type number*
4. **negotiation auto**
5. **pppoe enable group** *group-name*
6. **end**

DETAILED STEPS

	Command or Action	Purpose
Step 1	enable Example: Device> enable	Enables privileged EXEC mode. • Enter your password if prompted.
Step 2	configure terminal Example: Device# configure terminal	Enters global configuration mode.
Step 3	interface type number Example: Device(config)# interface GigabitEthernet 0/0/1	Specifies a Gigabit Ethernet interface for which Multilink PPP must be configured and enters interface configuration mode.
Step 4	negotiation auto Example: Device(config-if)# negotiation auto	Enables the autonegotiation protocol to configure the speed, duplex, and automatic flow control of the Gigabit Ethernet interface.
Step 5	pppoe enable group group-name Example: Device(config-if)# pppoe enable group mlpoe-bba-group-10m	Enables PPPoE sessions on an Ethernet interface or subinterface.
Step 6	end Example: Device(config-if)# end	Exits interface configuration mode and returns to privileged EXEC mode.

Configuring MLPoE over VLAN

SUMMARY STEPS

1. **enable**
2. **configure terminal**
3. **interface type number**
4. **encapsulation dot1q vlan-id**
5. **pppoe enable group group-name**
6. **end**

DETAILED STEPS

	Command or Action	Purpose
Step 1	enable Example: Device> enable	Enables privileged EXEC mode. • Enter your password if prompted.
Step 2	configure terminal Example: Device# configure terminal	Enters global configuration mode.
Step 3	interface type number Example: Device(config)# interface GigabitEthernet 0/0/0.1	Specifies the Gigabit Ethernet interface for which Multilink PPP must be configured and enters subinterface configuration mode.
Step 4	encapsulation dot1q vlan-id Example: Device(config-subif)# encapsulation dot1q 13	Enables IEEE 802.1q encapsulation of traffic on the specified subinterface in VLANs. • <i>vlan-id</i> is the virtual LAN identifier. The range is from 1 to 1000.
Step 5	pppoe enable group group-name Example: Device(config-subif)# pppoe enable group mlpoe-bba-group-10m	Enables PPPoE sessions on the subinterface.
Step 6	end Example: Device(config-subif)# end	Exits subinterface configuration mode and returns to privileged EXEC mode.

Configuring MLPoE over QinQ

SUMMARY STEPS

1. **enable**
2. **configure terminal**
3. **interface type number**
4. **encapsulation dot1q vlan-id second-dot1q {any | vlan-id | vlan-id-vlan-id | [, vlan-id-vlan-id]}**
5. **pppoe enable group group-name**
6. **end**

DETAILED STEPS

	Command or Action	Purpose
Step 1	enable Example: Device> enable	Enables privileged EXEC mode. • Enter your password if prompted.
Step 2	configure terminal Example: Device# configure terminal	Enters global configuration mode.
Step 3	interface type number Example: Device(config)# interface GigabitEthernet 0/0/1.1	Specifies the Gigabit Ethernet subinterface for which Multilink PPP must be configured and enters subinterface configuration mode.
Step 4	encapsulation dot1q vlan-id second-dot1q {any vlan-id vlan-id-vlan-id [, vlan-id-vlan-id]} Example: Device(config-subif)# encapsulation dot1q 14 second-dot1q 140	Enables IEEE 802.1q encapsulation of traffic on a specified subinterface in VLANs. • <i>vlan-id</i> is the Virtual LAN identifier. Enter a hyphen to separate the starting and ending VLAN ID values that are used to define a range of VLAN IDs. Optionally, enter a comma to separate each VLAN ID range from the next range. The range is from 1 to 4094.
Step 5	pppoe enable group group-name Example: Device(config-subif)# pppoe enable group mlpoe-bba-group-10m	Enables PPPoE sessions on an Ethernet interface or subinterface.
Step 6	end Example: Device(config-subif)# end	Exits subinterface configuration mode and returns to privileged EXEC mode.

Configuration Examples for MLPoE at PTA

Example: Configuring MLPoE at PTA

The following example shows how to configure the Multilink PPP over Ethernet (MLPoE) on the PTA device:

```
class-map match-all ip-prec-1
 match ip precedence 1
```

```

!
policy-map mlp-child-lfi-policy
  class ip-prec-1
    priority percent 10
policy-map mlp-parent-250K
  class class-default
    shape average 250000
    service-policy mlp-child-lfi-policy
policy-map mlp-parent-10M
  class class-default
    shape average 10000000
    service-policy mlp-child-lfi-policy
interface virtual-template 15
  description MLPoE/oEoVLAN/oEoQinQ (single-link bundle) Virtual Template
  ip address negotiated
  peer default ip address pool MLP-IPv4-Pool
  ppp max-failure 30
  ppp chap password 0 password1
  ppp multilink
  ppp multilink interleave
  ppp multilink endpoint magic-number
  ppp timeout retry 4
  service-policy output mlp-parent-10M
bba-group pppoe mlpoe-bba-group-10M
  virtual-template 15
ip local pool MLP-IPv4-Pool 209.165.201.2 209.165.201.10
interface GigabitEthernet 0/0/0
  description MLPoE (Single-Link Bundles) Session (PTA Mode) to 7200-41 0/1
  no ip address
  negotiation auto
  pppoe enable group mlpoe-bba-group-10M

```

Example: Configuring MLPoE over VLAN

The following example shows how to configure Multilink PPP over Ethernet over VLAN (MLPoEoVLAN) on the PTA device:

```

class-map match-all ip-prec-1
  match ip precedence 1
policy-map mlp-child-lfi-policy
  class ip-prec-1
    priority percent 10
policy-map mlp-parent-250K
  class class-default
    shape average 250000
    service-policy mlp-child-lfi-policy
policy-map mlp-parent-10M
  class class-default
    shape average 10000000
    service-policy mlp-child-lfi-policy
interface virtual-template 15
  description MLPoE/oEoVLAN/oEoQinQ (single-link bundle) Virtual Template
  ip address negotiated
  peer default ip address pool MLP-IPv4-Pool
  ppp max-failure 30
  ppp chap password 0 password1
  ppp multilink
  ppp multilink interleave
  ppp multilink endpoint magic-number
  ppp timeout retry 4
  service-policy output mlp-parent-10M
bba-group pppoe mlpoe-bba-group-10M
  virtual-template 15
ip local pool MLP-IPv4-Pool 209.165.201.2 209.165.201.10
interface GigabitEthernet 0/0/0.13
  description MLPoEoVLAN Session (Single-Link Bundles) Session (PTA Mode)
  encapsulation dot1Q 13
  pppoe enable group mlpoe-bba-group-10M

```

Example: Configuring MLPoE over QinQ

The following example shows how to configure Multilink PPP over Ethernet over Queue-in-Queue (MLPoEoQinQ) on the PTA device:

```
class-map match-all ip-prec-1
 match ip precedence 1
policy-map mlp-child-lfi-policy
 class ip-prec-1
  priority percent 10
policy-map mlp-parent-250K
 class class-default
  shape average 250000
  service-policy mlp-child-lfi-policy
policy-map mlp-parent-10M
 class class-default
  shape average 10000000
  service-policy mlp-child-lfi-policy
interface virtual-template 15
 description MLPoE/oEoVLAN/oEoQinQ (single-link bundle) Virtual Template
 ip address negotiated
 peer default ip address pool MLP-IPv4-Pool
 ppp max-failure 30
 ppp chap password 0 password1
 ppp multilink
 ppp multilink interleave
 ppp multilink endpoint magic-number
 ppp timeout retry 4
  service-policy output mlp-parent-10M
 bba-group pppoe mlpoe-bba-group-10M
 virtual-template 15
 ip local pool MLP-IPv4-Pool 40.1.0.1 40.1.0.6
interface GigabitEthernet 0/0/0.14
 description MLPoEoQinQ Sessions (Single-Link Bundles) Session (PTA Mode)
 encapsulation dot1Q 14 second-dot1q 140
 pppoe enable group mlpoe-bba-group-10M
```

Additional References for MLPoE at PTA

Related Documents

Related Topic	Document Title
Cisco IOS commands	Cisco IOS Master Command List, All Releases
PPP commands	Dial Technologies Command Reference
Multilink PPP	<i>Multilink PPP Feature Functionality on the ASR 1000 Series Aggregation Services Router</i>

Standards and RFCs

Standard/RFC	Title
RFC 1990	<i>The PPP Multilink Protocol (MP)</i>

Standard/RFC	Title
RFC 2686	<i>The Multi-Class Extension to Multi-Link PPP</i>

MIBs

Technical Assistance

Description	Link
The Cisco Support and Documentation website provides online resources to download documentation, software, and tools. Use these resources to install and configure the software and to troubleshoot and resolve technical issues with Cisco products and technologies. Access to most tools on the Cisco Support and Documentation website requires a Cisco.com user ID and password.	http://www.cisco.com/cisco/web/support/index.html

Feature Information for MLPoE at PTA

The following table provides release information about the feature or features described in this module. This table lists only the software release that introduced support for a given feature in a given software release train. Unless noted otherwise, subsequent releases of that software release train also support that feature.

Use Cisco Feature Navigator to find information about platform support and Cisco software image support. To access Cisco Feature Navigator, go to www.cisco.com/go/cfn. An account on Cisco.com is not required.

Table 5: Feature Information for Multilink PPP Over Ethernet at PTA

Feature Name	Releases	Feature Information
MLPoE at PTA	12.2(33)XNE Cisco IOS XE Release 3.4S Cisco IOS XE Release 3.10S Cisco IOS XE Release 3.12S	Multilink PPP over Ethernet (MLPoE) at PPP Termination and Aggregation (PTA) feature allows the customer premises equipment (CPE) and PTA devices to interleave high-priority and low-latency packets (PPP encapsulated) between MLPPP fragments of lower-priority and higher-latency packets.



Configurable CHAP Challenge Length

The Configurable Challenge Handshake Authentication Protocol (CHAP) Challenge Length feature allows you to configure the length of the CHAP challenge by specifying the minimum and maximum allowable challenge lengths in bytes.

- [Prerequisites for Configurable CHAP Challenge Length, page 83](#)
- [Information About Configurable CHAP Challenge Length, page 83](#)
- [How to Configure Configurable CHAP Challenge Length, page 84](#)
- [Configuration Examples for Configurable CHAP Challenge Length, page 85](#)
- [Additional References for Configurable CHAP Challenge Length, page 85](#)
- [Feature Information for Configurable CHAP Challenge Length, page 86](#)

Prerequisites for Configurable CHAP Challenge Length

The PPP encapsulation must be configured on the interface.

Information About Configurable CHAP Challenge Length

Configurable CHAP Challenge Length Overview

Challenge Handshake Authentication Protocol (CHAP) along with PPP is used to provide remote-device information to the central site. It verifies the identity of the peer by means of a three-way handshake.

When CHAP is enabled on any interface that supports PPP encapsulation, and a remote device attempts to connect to it, the local device or the access server sends a CHAP packet to the remote device. The CHAP packet requests or “challenges” the remote device to respond.

By default, the CHAP challenge is sent with a fixed 16-byte length to the peer. The Configurable CHAP Challenge Length feature allows the configuration of variable CHAP challenge lengths. A variable challenge length reduces the probability of an attacker predicting the challenge, thus optimizing the security.

Use the **ppp chap challenge-length** command to configure the CHAP challenge lengths.

How to Configure Configurable CHAP Challenge Length

Configuring Configurable CHAP Challenge Length

SUMMARY STEPS

1. `enable`
2. `configure terminal`
3. `interface virtual-template number`
4. `ppp authentication chap`
5. `ppp chap challenge-length min-length max-length`
6. `end`

DETAILED STEPS

	Command or Action	Purpose
Step 1	<code>enable</code> Example: Device> enable	Enables privileged EXEC mode. • Enter your password if prompted.
Step 2	<code>configure terminal</code> Example: Device# configure terminal	Enters global configuration mode.
Step 3	<code>interface virtual-template <i>number</i></code> Example: Device(config)# interface virtual-template 1	Creates a virtual template interface and enters interface configuration mode. The range is from 1 to 4095.
Step 4	<code>ppp authentication chap</code> Example: Device(config-if)# ppp authentication chap	Enables CHAP authentication.
Step 5	<code>ppp chap challenge-length <i>min-length max-length</i></code> Example: Device(config-if)# ppp chap challenge-length 20 30	Configures the minimum and maximum CHAP challenge lengths in bytes. The range is from 16 to 63.
Step 6	<code>end</code> Example: Device(config-if)# end	Exits interface configuration mode and returns to privileged EXEC mode.

Configuration Examples for Configurable CHAP Challenge Length

Example: Configuring Configurable CHAP Challenge Length

The following example shows how to configure the Challenge Handshake Authentication Protocol (CHAP) challenge lengths:

```
Device> enable
Device# configure terminal
Device(config)# interface virtual-template 1
Device(config-if)# ppp authentication chap
Device(config-if)# ppp chap challenge-length 20 30
Device(config-if)# end
```

Additional References for Configurable CHAP Challenge Length

Related Documents

Related Topic	Document Title
Cisco IOS commands	Cisco IOS Master Command List, All Releases
PPP commands	Dial Technologies Command Reference
Wide-area networking commands	Wide-Area Networking Command Reference

Technical Assistance

Description	Link
<p>The Cisco Support website provides extensive online resources, including documentation and tools for troubleshooting and resolving technical issues with Cisco products and technologies.</p> <p>To receive security and technical information about your products, you can subscribe to various services, such as the Product Alert Tool (accessed from Field Notices), the Cisco Technical Services Newsletter, and Really Simple Syndication (RSS) Feeds.</p> <p>Access to most tools on the Cisco Support website requires a Cisco.com user ID and password.</p>	http://www.cisco.com/cisco/web/support/index.html

Feature Information for Configurable CHAP Challenge Length

The following table provides release information about the feature or features described in this module. This table lists only the software release that introduced support for a given feature in a given software release train. Unless noted otherwise, subsequent releases of that software release train also support that feature.

Use Cisco Feature Navigator to find information about platform support and Cisco software image support. To access Cisco Feature Navigator, go to www.cisco.com/go/cfn. An account on Cisco.com is not required.

Table 6: Feature Information for Configurable CHAP Challenge Length

Feature Name	Releases	Feature Information
Configurable CHAP Challenge Length	Cisco IOS XE Release 3.12S	<p>The Configurable Challenge Handshake Authentication Protocol (CHAP) feature allows you to configure the length of the CHAP challenge by specifying the minimum and maximum allowable challenge length in bytes.</p> <p>The following command was introduced: ppp chap challenge-length.</p>