



Cisco Unified Attendant Console Advanced Design Guide

January 12, 2023

Cisco Systems, Inc.
www.cisco.com

Cisco has more than 200 offices worldwide. Addresses, phone numbers, and fax numbers are listed on the Cisco website at www.cisco.com/go/offices.

THE SPECIFICATIONS AND INFORMATION REGARDING THE PRODUCTS IN THIS MANUAL ARE SUBJECT TO CHANGE WITHOUT NOTICE. ALL STATEMENTS, INFORMATION, AND RECOMMENDATIONS IN THIS MANUAL ARE BELIEVED TO BE ACCURATE BUT ARE PRESENTED WITHOUT WARRANTY OF ANY KIND, EXPRESS OR IMPLIED. USERS MUST TAKE FULL RESPONSIBILITY FOR THEIR APPLICATION OF ANY PRODUCTS.

THE SOFTWARE LICENSE AND LIMITED WARRANTY FOR THE ACCOMPANYING PRODUCT ARE SET FORTH IN THE INFORMATION PACKET THAT SHIPPED WITH THE PRODUCT AND ARE INCORPORATED HEREIN BY THIS REFERENCE. IF YOU ARE UNABLE TO LOCATE THE SOFTWARE LICENSE OR LIMITED WARRANTY, CONTACT YOUR CISCO REPRESENTATIVE FOR A COPY.

The Cisco implementation of TCP header compression is an adaptation of a program developed by the University of California, Berkeley (UCB) as part of UCB's public domain version of the UNIX operating system. All rights reserved. Copyright © 1981, Regents of the University of California.

NOTWITHSTANDING ANY OTHER WARRANTY HEREIN, ALL DOCUMENT FILES AND SOFTWARE OF THESE SUPPLIERS ARE PROVIDED "AS IS" WITH ALL FAULTS. CISCO AND THE ABOVE-NAMED SUPPLIERS DISCLAIM ALL WARRANTIES, EXPRESSED OR IMPLIED, INCLUDING, WITHOUT LIMITATION, THOSE OF MERCHANTABILITY, FITNESS FOR A PARTICULAR PURPOSE AND NONINFRINGEMENT OR ARISING FROM A COURSE OF DEALING, USAGE, OR TRADE PRACTICE.

IN NO EVENT SHALL CISCO OR ITS SUPPLIERS BE LIABLE FOR ANY INDIRECT, SPECIAL, CONSEQUENTIAL, OR INCIDENTAL DAMAGES, INCLUDING, WITHOUT LIMITATION, LOST PROFITS OR LOSS OR DAMAGE TO DATA ARISING OUT OF THE USE OR INABILITY TO USE THIS MANUAL, EVEN IF CISCO OR ITS SUPPLIERS HAVE BEEN ADVISED OF THE POSSIBILITY OF SUCH DAMAGES.

CCDE, CCENT, CCSI, Cisco Eos, Cisco HealthPresence, Cisco Ironport, the Cisco logo, Cisco Lumin, Cisco Nexus, Cisco Nurse Connect, Cisco Stackpower, Cisco StadiumVision, Cisco TelePresence, Cisco Unified Computing System, Cisco WebEx, DCE, Flip Channels, Flip for Good, Flip Mino, Flip Video, Flip Video (Design), Flipshare (Design), Flip Ultra, and Welcome to the Human Network are trademarks; Changing the Way We Work, Live, Play, and Learn, Cisco Store, and Flip Gift Card are service marks; and Access Registrar, Aironet, AsyncOS, Bringing the Meeting To You, Catalyst, CCDA, CCDP, CCIE, CCIP, CCNA, CCNP, CCSP, CCVP, Cisco, the Cisco Certified Internetwork Expert logo, Cisco IOS, Cisco Press, Cisco Systems, Cisco Systems Capital, the Cisco Systems logo, Cisco Unity, Collaboration Without Limitation, EtherFast, EtherSwitch, Event Center, Fast Step, Follow Me Browsing, FormShare, GigaDrive, HomeLink, Internet Quotient, IOS, iPhone, iQuick Study, IronPort, the IronPort logo, LightStream, Linksys, MediaTone, MeetingPlace, MeetingPlace Chime Sound, MGX, Networkers, Networking Academy, Network Registrar, PCNow, PIX, PowerPanels, ProConnect, ScriptShare, SenderBase, SMARTnet, Spectrum Expert, StackWise, The Fastest Way to Increase Your Internet Quotient, TransPath, WebEx, and the WebEx logo are registered trademarks of Cisco Systems, Inc. and/or its affiliates in the United States and certain other countries.

All other trademarks mentioned in this document or website are the property of their respective owners. The use of the word partner does not imply a partnership relationship between Cisco and any other company. (0907R)

Any Internet Protocol (IP) addresses and phone numbers used in this document are not intended to be actual addresses and phone numbers. Any examples, command display output, network topology diagrams, and other figures included in the document are shown for illustrative purposes only. Any use of actual IP addresses or phone numbers in illustrative content is unintentional and coincidental.

Cisco Unified Attendant Console Advanced Design Guide
© 2023 Cisco Systems, Inc. All rights reserved.



About This Document vii

Audience vii

Abbreviations Used In This Document viii

Conventions ix

Obtaining Documentation and Submitting Service Requests ix

CHAPTER 1

Introduction to Cisco Unified Attendant Console Advanced 1-1

Controlled CTI Devices 1-1

 Controlled CTI Device Provisioning 1-2

 Call Delivery Methods 1-3

Cisco Unified Attendant Console Advanced User Accounts 1-3

Cisco Unified Attendant Console Advanced Server 1-3

Cisco Unified Attendant Console Advanced Server Virtualization 1-4

 VMware Guest Machine Requirements 1-5

 VMware Guest Machine Disk Space 1-5

 Cisco Unified Communications Manager and Cisco Unified Attendant Console
 Advanced Server Co-residency 1-6

Server Prerequisites 1-7

 Server Identification 1-7

 Add Web Server Internet Information Services 1-7

SQL Database 1-7

 SQL Installation Prerequisites 1-7

 Database Problems 1-8

 SQL Server Express Host Name Too Long 1-8

 Duplicate Server CIDs 1-8

 Model Database Too Small 1-9

System Hardening 1-9

CHAPTER 2

Cisco Unified Attendant Console Advanced Architecture 2-1

System Architecture Overview 2-1

 Bandwidth and Latency 2-3

 Cisco TSP Timeouts 2-4

 Cisco TSP Updates 2-4

CTI Architecture 2-4

CTI Request Information Flow	2-5
Cisco Unified Attendant Console Advanced CTI Setup	2-7
CTI Resilience	2-7
Call Flow Diagrams	2-9
Centralized Installations and Transcoding	2-13
Example Installation Requiring Transcoding	2-14
Network Bandwidth Consumption	2-18
Sample Topologies	2-19
Single Site Topology	2-19
Centralized Cisco Unified Attendant Console Advanced Server with Local and Remote Clients	2-20
AXL Connectivity	2-21
AXL Usage During Installation	2-21
AXL Usage After Installation	2-21
Standalone Installation Scenarios	2-22
Resilient Installation Scenarios	2-22
Cisco Unified Attendant Console Advanced Web Administration	2-23

CHAPTER 3**Cisco Unified Communications Manager Compatibility 3-1**

Calling Search Spaces and Partitions	3-1
Answering Calls	3-2
Consult Transfer	3-3
Blind Transfer (Standard Functionality)	3-4
Blind Transfer (Direct Transfer)	3-5
Night Service/Overflows/Out of Service	3-6
Queue Overflow - Best Practice	3-6
Holding Calls	3-8
Parking Calls	3-9
Call Flow Example With Partition/CSS	3-10
Configuring Controlled CTI Devices	3-11
Configuring CTI Manager and Cisco TSP	3-11
Supported Handsets	3-12
Jabber Support	3-20

CHAPTER 4**Dial Plans 4-1**

Number Validation Process	4-1
No Access Number or Country Code Configuration	4-2
External Access Number	4-2
External International Access Number	4-2

Exclude Local Country Code	4-3
Sample Configurations	4-4

CHAPTER 5

Cisco Unified Attendant Console Advanced Resilience 5-1

Full Resilience	5-1
Database Replication	5-2
System Configuration	5-5
Failover Scenarios	5-5
Full Failover	5-5
Partial Failover	5-5
Full CTI Failover	5-6
Providing Additional Resilience	5-6
CTI Manager Service Failure	5-6
Cisco Unified Communications Manager Failure	5-7
Client Handset Resets	5-7

CHAPTER 6

Directory Contacts, Devices and Line Status 6-1

Populating the Directory	6-1
Searching the Directory	6-2
Assigning Device Names to DNs (Cisco Unified Communications Manager)	6-2
Assigning Device Names to DNs (External Sources)	6-2
Caller ID and Contact Matching	6-3
Scenarios which trigger Caller ID and Contact Matching in Call Tags	6-3
Caller ID and Contact Matching Prioritization	6-3
Multiple Contact Matches within a Single Contact Matching Source	6-3
Cisco Unified Communications Manager PBX - Caller ID	6-4
Monitor Change Notifications	6-5
BLF Plug-in	6-5
Amending Device Names	6-7
Device Selection	6-7
Shared Line Support	6-10
Device-based Monitoring	6-10

CHAPTER 7

Presence Integration 7-1

Cisco IM&P Server Integration	7-2
MOC and Lync Integration	7-3

CHAPTER 8**Cisco Unity Voicemail Integration 8-1**

Configuring Cisco Unified Attendant Console Advanced Voicemail Access 8-1

Call Arrival Mode 8-2

CHAPTER 9**Antivirus and Remote Access Application Support 9-1**

Remote Access Application Support 9-1

APPENDIX A**AXL/Database Field Mappings A-1**

Phone Mappings A-1

CTI Route Point Mappings A-3

Directory Number (Line) Mappings A-4

Devicenumplanmap Mappings A-6



About This Document

This document contains information to help you plan, implement and administer your Cisco Unified Attendant Console Advanced system. It applies to all major releases of Cisco Unified Attendant Console Advanced, and it covers the following major topics:

- [Chapter 1, “Introduction to Cisco Unified Attendant Console Advanced”](#)
- [Chapter 2, “Cisco Unified Attendant Console Advanced Architecture”](#)
- [Chapter 3, “Cisco Unified Communications Manager Compatibility”](#)
- [Chapter 4, “Dial Plans”](#)
- [Chapter 5, “Cisco Unified Attendant Console Advanced Resilience”](#)
- [Chapter 6, “Directory Contacts, Devices and Line Status”](#)
- [Chapter 7, “Presence Integration”](#)
- [Chapter 8, “Cisco Unity Voicemail Integration”](#)
- [Chapter 9, “Antivirus and Remote Access Application Support”](#)
- [Appendix A, “AXL/Database Field Mappings”](#)

Audience

This document is for anyone involved with the planning, implementation and administration of a Cisco Unified Attendant Console Advanced system. It assumes basic knowledge of the Cisco Unified Attendant Console Advanced and Cisco Unified Communications Manager.

Use this document in conjunction with the *Cisco Unified Attendant Console Advanced Web Administration and Installation Guide*.

Abbreviations Used In This Document

This document uses the following abbreviations:

Abbreviation	Name
API	Application Programming Interface
AXL	AVVID XML Layer
BLF	Busy Lamp Field
CSS	Calling Search Spaces
CT	Computer Telephony
CTI	Computer Telephony Integration
CUACA	Cisco Unified Attendant Console Advanced
CUCM	Cisco Unified Communications Manager
CUP	Cisco Unified Presence
CUPS	Cisco Unified Presence server
DB	Database
DDI/DID	Direct Dial In/Direct Inward Dialing
DN	Directory Number
DND	Do Not Disturb
DNS	Domain Name System
HTTP	Hypertext Transport Protocol
LAN	Local Area Network
LDAP	Lightweight Directory Access Protocol
MAC	Media Access Control
MOC	Microsoft Office Communicator
MOH	Music On Hold
MSDTC	Microsoft Distributed Transaction Coordinator
OCS	Office Communications Server
PBX	Private Branch Exchange
PCM	Pulse Code Modulation
PSTN	Public Switched Telephone Network
RID	Resource Identifier
RSS	Really Simple Syndication
RTT	Round Trip Time
SCCP	Skinny Call Control Protocol
SIP	Session Initiation Protocol
SQL	A language for manipulating databases
SRTP	Secure Real-time Transport Protocol
SSL	Secure Sockets Layer

Abbreviation	Name
TAPI	Telephony Application Programming Interface
TCP/IP	Transmission Control Protocol/Internet Protocol
TSP	Telephony Service Provider
UC_SRND	Unified Communications Solution Reference Network Design
UCST	Unified Communications Sizing Tool
WAN	Wide Area Network
WMI	Windows Management Instrumentation
XML	Extensible Markup Language

Conventions

This document uses the following typographical conventions:

Convention	Indication
bold font	Commands and keywords and user-entered text appear in bold font .
<i>italic font</i>	Document titles, new or emphasized terms, and arguments for which you supply values are in <i>italic font</i> .
[]	Elements in square brackets are optional.
{x y z }	Required alternative keywords are grouped in braces and separated by vertical bars.
[x y z]	Optional alternative keywords are grouped in brackets and separated by vertical bars.
string	A non-quoted set of characters. Do not use quotation marks around the string.
<code>courier font</code>	Terminal sessions and information the system displays appear in <code>courier font</code> .
< >	Non-printing characters such as passwords are in angle brackets.
[]	Default responses to system prompts are in square brackets.
!, #	An exclamation point (!) or hash sign (#) at the start of a code line indicates a comment.



Note

Means *reader take note*.



Tip

Means *the following information will help you solve a problem*.

Obtaining Documentation and Submitting Service Requests

For information on:

- Obtaining documentation
- Obtaining support

- Submitting service requests
- Providing documentation feedback
- Security guidelines
- Recommended aliases
- Gathering additional information
- A list of all new and revised Cisco technical documentation

see the monthly *What's New in Cisco Product Documentation* at:
<http://www.cisco.com/en/US/docs/general/whatsnew/whatsnew.html>

Subscribe to *What's New in Cisco Product Documentation* as a Really Simple Syndication (RSS) feed and set content to be delivered directly to your desktop using a reader application. The RSS feeds are a free service and Cisco currently supports RSS Version 2.0.



Introduction to Cisco Unified Attendant Console Advanced

This chapter provides a brief introduction to Cisco Unified Attendant Console Advanced, including the following:

- [Controlled CTI Devices](#)
- [Cisco Unified Attendant Console Advanced User Accounts](#)
- [Cisco Unified Attendant Console Advanced Server](#)
- [Cisco Unified Attendant Console Advanced Server Virtualization](#)
- [Server Prerequisites](#)
- [SQL Database](#)

Cisco Unified Attendant Console Advanced is a Windows-based operator attendant console application for use exclusively with Cisco Unified Communications Manager. Cisco Unified Attendant Console Advanced emulates the functions of a manual telephone switchboard, and so enables Cisco Unified Attendant Console Advanced operators to quickly accept incoming calls and efficiently dispatch them to recipients within an organization. Cisco Unified Attendant Console Advanced has a Client/server architecture and uses the Cisco TSP to communicate with Cisco Unified Communications Manager for call control.

Controlled CTI Devices

Cisco Unified Communications Manager uses the following types of *Controlled CTI Devices*:

- Computer Telephony Integration (CTI) Ports—virtual phones that can terminate calls. They can be used for queuing calls and can play music on hold to the caller.
- Computer Telephony Integration (CTI) Route Points—virtual devices that can receive multiple, simultaneous calls for application-controlled redirection. They cannot terminate (answer) calls.

Cisco Unified Attendant Console Advanced uses these types of Controlled CTI Devices:

Cisco Unified Attendant Console Advanced Device	Cisco Unified Communications Manager Device Type	Description/Use
CT Gateway	CTI Port	When a call reaches a Queue DDI (see below), the Cisco Unified Attendant Console Advanced server informs the Cisco Unified Communications Manager to move the call to a CT Gateway device. The CT Gateway is used for queuing calls in the Cisco Unified Attendant Console Advanced system that have not yet been answered.
Queue DDI	CTI Route Point	Each Cisco Unified Attendant Console Advanced queue configured has a DDI. Incoming calls to the Cisco Unified Attendant Console Advanced system must be routed to these DDI devices, either directly or through translation.
Service Queues	CTI Port	Service Queues are used by Cisco Unified Attendant Console Advanced to manage calls after they leave the operator's handset. For example, to hold, transfer and call camp on. These devices are only used by Cisco Unified Attendant Console Advanced Clients.
Park Devices	CTI Port	Park devices are used by the Cisco Unified Attendant Console Advanced to park calls. Cisco Unified Attendant Console Advanced Call Park functionality is separate from Cisco Unified Communications Manager Call Park functionality.

Each Cisco Unified Attendant Console Advanced queue has its own resource group—a *Queue Device Group*—with its own audio source for music on hold; calls to the queue DDI number use the devices in a resource group pool.

The maximum number of system devices (including CT Gateway devices, Service devices, and Park devices) supported by a Cisco Unified Attendant Console Advanced Server is 1000. This total does not include Queue DDIs, which are CTI Route Points. The system devices can be distributed among up to 100 Queue Device Groups. You cannot save more than 100 devices per transaction.

Controlled CTI Device Provisioning

When installing Cisco Unified Attendant Console Advanced you must calculate how many Controlled CTI Devices to configure on the Cisco Unified Communications Manager.

To help you do this you can use the Unified Communications Sizing Tool (UCST) available at <http://tools.cisco.com/cucst>.

CTI Ports include CT Gateway device, Service Queues and Park Device. The maximum number of CTI Ports you can configure is 1000 per server.

Cisco recommends the following:

- CT Gateway—Configure one CT Gateway for each PSTN line and add 10 ports for other incoming calls, for example, internal calls to the queues.

- Queue DDI—Configure one Queue DDI for each DDI/DID routed into the Cisco Unified Attendant Console Advanced server.
- Service Queues—Configure a minimum of two Service Queues per Cisco Unified Attendant Console Advanced user.

**Note**

If the operators are using the advanced processing option to transfer calls directly to the destination, you can reduce the number of service queue devices.

- Park Devices—Configure at least one Park Device per Cisco Unified Attendant Console Advanced user. The number you configure depends on how often you expect to park calls from the operator.

Call Delivery Methods

The default, broadcast call delivery has the call holding/ringing a CTI Port and being displayed on the attendant console. When the call is answered it is redirected from the CTI Port to the attendant's handset.

Forced delivery makes an enquiry call from the CTI Port to the next attendant handset in a circular, round-robin pattern (determined by the order in which they log in). Attendants receive calls in a specific order, and after the last receives a call, the first receives the next one. Attendants are skipped if they are still busy on a previous call.

Cisco Unified Attendant Console Advanced User Accounts

The Cisco Unified Attendant Console Advanced server must be able to communicate with its assigned Cisco Unified Communications Manager cluster (using Cisco TSP and AXL) to enable Cisco Unified Attendant Console Advanced directory synchronization (if you are using the Cisco Unified Communications Manager directory), busy lamp field (endpoint line state) and call control. To achieve this, Cisco Unified Attendant Console Advanced uses an *Application User*. For more information about Application Users, including how to create them, see the *Cisco Unified Attendant Console Advanced Web Admin and Installation Guide*.

If you are using Cisco Unified Attendant Console Advanced in resilience mode, you require two Application Users—one for each server—and you must assign the same roles to both.

Cisco Unified Attendant Console Advanced Server

The Cisco Unified Attendant Console Advanced server consists of several components, including:

- Cisco Unified Attendant Console Advanced Server, responsible for call control and directory synchronization
- Cisco Unified Attendant BLF Plug-in, responsible for phone line status information
- Cisco Unified Attendant Presence Plug-in, responsible for presence information
- Cisco Unified Attendant Console Advanced Administration Server, responsible for administration interface
- Cisco Unified Attendant LDAP Plug-in, responsible for connecting the Cisco Unified Attendant Console Advanced Server to the Cisco Unified Communications Manager.

Cisco Unified Attendant Console Advanced Clients connect to the Cisco Unified Attendant Console Advanced server over the following ports:

- 1433 for the SQL server
- 1859 for call control
- 1863 for presence information
- 1864 for phone line status

For a full list of IP ports used by Cisco Unified Attendant Console Advanced, see [Sample Topologies](#).

In small installations with only one or two Cisco Unified Attendant Console Advanced Clients, one of the Console Clients is sometimes run on the machine hosting the Cisco Unified Attendant Console Advanced server. In such a situation, if the system is not resilient, the attendant using that Client must not turn off the machine.

You can install multiple Cisco Unified Attendant Console Advanced servers on a single Cisco Unified Communications Manager cluster; however:

- Each server must use separate TSP User Profile.
- Each Cisco Unified Attendant Console Advanced Client must communicate with just one Cisco Unified Attendant Console Advanced server.
- The total number of CTI devices used by all the Cisco Unified Attendant Console Advanced servers must not exceed the Cisco recommended maximum (see the Cisco UC Solution Reference Network Design for details).
- You must provide sufficient CTI resources for any other CTI applications that may require them.

Cisco Unified Attendant Console Advanced Server Virtualization

In a production environment, Cisco Unified Attendant Console Advanced server runs on either a:

- Physical server
- Virtual environment, compliant with Cisco's Specifications-Based Hardware Support program. For more information, see https://www.cisco.com/c/dam/en/us/td/docs/voice_ip_comm/uc_system/virtualization/virtualization-cisco-unified-attendant-consoles.html.



Note

Cisco Unified Attendant Console Advanced server is *not* supported in HyperV or any other virtualization products other than VMware.

For more information about VMware requirements, feature support and services visit:

https://www.cisco.com/c/dam/en/us/td/docs/voice_ip_comm/uc_system/virtualization/virtualization-software-requirements.html.

For more information about Unified Communications application and version compatibility with a virtualized hardware support models visit

https://www.cisco.com/c/dam/en/us/td/docs/voice_ip_comm/uc_system/virtualization/cisco-collaboration-virtualization.html.

VMware Guest Machine Requirements

Cisco Unified Attendant Console Advanced server has the following minimum VMware guest machine (instance) requirements:

- 2x vCPU unrestricted
- 6 GB RAM
- 120 GB of available hard disk space



Note

You can download an OVA template configured with the above specifications from the following location: <https://cisco.com/go/ac>.

VMware Guest Machine Disk Space

When assigning disk space while creating your guest machine you must consider the following:

- Logging Files
- Database Growth

Logging File Disk Space Requirements

Cisco Unified Attendant Console Advanced generates logging files on the server for use during troubleshooting. You can set different logging levels, although the default is generally sufficient for initial investigations.

For each relevant server process, you can set the number of stored files and the number of lines per file, and for the main server you can specify which processes to log.

The default space requirements are shown in the following table.

Server Application	Number of Files	Lines Per File	File Size (MB)
Attendant Server	10	10K	16.8
Attendant LDAP	10	200K	53.3
Attendant CUPS	50	10K	15
Attendant Admin	50	200K	182
BLF Plug-in	100	100K	1792
Middleware	15	Not applicable	631

Database Disk Space Requirements

Configuration and usage determine the size of the databases. This section describes configuration and logging database requirements based on a system consisting of:

- 10 operators
- 255 configured CTI devices
- 10 queues
- 10,000 imported contacts

Configuration Database

The following table shows the size of the Configuration Database.

Item	Default Size (KB)	Number of Items	Total Size (KB)
Default database Size (MDF+LDF)	102400	1	102400
Operator	1.1	10	11
CTI Device	0.468	255	119.34
Queue	46.7	10	467
Queued Message (MBUS)	69632	1	69632
Imported Contact	172	10000	1720000
Total Database Size			1892629.3

Once configured, the configuration database is unlikely to grow, unless more configuration is added. The number of contacts in the system has the largest impact on database size; when fully populated, each contact uses up 172KB of storage.

Logging Database

The following table shows the size of the Logging Database.

Item	Default Size (KB)	Number of Items	Total Size (KB)
Default database size (MDF+LDF)	378880	1	378880
Operator	1.1	50	55
Devices	0.468	255	119.34
Queues	46.7	100	4670
Calls	161	100000	16100000
Agent (Sessions)	79.872	100000	7987200
Total Database Size			24470924.34

This database always grows over time as it stores details of all calls and attendant transactions – including logging in/out, answering calls, and making transfers.

Cisco Unified Communications Manager and Cisco Unified Attendant Console Advanced Server Co-residency

Cisco Unified Attendant Console Advanced server can co-reside with Cisco Unified Communications Manager on both B and C series Unified Computing System (UCS) servers. For more information, visit http://docwiki.cisco.com/wiki/Virtualization_for_Cisco_Unified_Attendant_Consoles#IOPS_and_Storage_System_Performance_Requirement

Server Prerequisites

Once an operating system has been installed on a server machine several other things must be installed or configured before installing the Cisco Unified Attendant Console Advanced Server.

- [Server Identification, page 1-7](#)
- [Add Web Server Internet Information Services, page 1-7](#)

Server Identification

The server is the engine of the Cisco Unified Attendant Console Advanced system, and as such needs to communicate with all the computers that run the Cisco Unified Attendant Console Advanced Client. Cisco Unified Attendant Console Advanced communicates by machine name, using Dynamic Host Configuration Protocol (DHCP) to allocate IPv4 addresses.

During Client installation you are prompted for the Fully Qualified Domain Name (FQDN) or the machine name of the server, and this is tested to ensure that communication is working. Consequently, you need to ensure that the server has a proper, useful machine name.

Add Web Server Internet Information Services

Internet Information Services (IIS) must be added before installing Cisco Unified Attendant Console Advanced, as it required by the web browser-based Administration interface, which is accessible from any Windows PC with appropriate network access.

SQL Database

Cisco Unified Attendant Console Advanced uses Microsoft SQL Server for all its database storage, including its contact directory, system configuration data, and call activity logging. It uses two databases, which are created on the local machine (both the Publisher and Subscriber Servers) during installation.

To obtain a list of supported SQL Server versions, refer to the [Release Notes](#).

SQL Installation Prerequisites

This section describes the SQL Server installation prerequisites, which – if satisfied – will ensure that the Cisco Unified Attendant Console Advanced Resilience installation wizard will run without error.

SQL Prerequisites

If you are installing a replicated/resilient system, you must install SQL Server *exclusively* for use by Cisco Unified Attendant Console Advanced to ensure that the default collation settings are correct.

Before installing SQL Server, do the following:

- Provide a valid SQL user with SysAdmin privileges.
- Ensure that the Windows Hostname and SQL hostname are identical. If Windows gets renamed then SQL needs to be renamed to match.

SQL Server Prerequisites for SQL Replication/Resilience

The following prerequisites are for resilient SQL Server installations only:

- A full version of SQL Server must be installed on the Publisher Server.
- The network must possess fully functioning Name lookup (DNS). SQL replication can only use hostnames; it cannot use IP addresses.
- If using SQL replication:
 - Ensure that the CID of the Publisher and Subscriber Servers are unique. To confirm this run `regedit` and browse to `HKEY_CLASSES_ROOT\CID`. If any of the listed CIDs match any on the other server then you will need to generate a new CID by reinstalling the MSDTC service, as described in [Duplicate Server CIDs, page 1-8](#).

Database Problems

Cisco Unified Attendant Console Advanced databases must be set up correctly. This section describes common database problems.

SQL Server Express Host Name Too Long

The SQL Server Express host name cannot be more than 15 characters long.

Duplicate Server CIDs

Due to the way the database resilience is set up, every Publisher or Subscriber server configuration must have a unique CID, which is used by SQL server to identify machines in the network.



Note

To view a machine's CIDs, run **regedit** and browse to `HKEY_CLASSES_ROOT\CID`.

However, laboratory and production environments often use machine cloning or copying, and this can result in multiple machines (or virtual machines) having the same CID. If several machines do have the same CID, you can generate new, unique ones by reinstalling the Windows MSDTC service on both the Publisher and Subscriber servers.

To reinstall the MSDTC service, on each server do the following:

-
- Step 1** Open a command prompt with administrator rights.
 - Step 2** Enter **MSDTC -uninstall**.
 - Step 3** Enter **MSDTC -install**.
 - Step 4** Reboot the system.
 - Step 5** Re-set the MSDTC service to Automatic start-up.
-



Note

This procedure may also stop the MSDTC service on the other server.

Model Database Too Small

Cisco Unified Attendant Console Advanced creates its two databases during installation. The default installation size of each is 3MB, and your model database size must be at least this for Cisco Unified Attendant Console Advanced to be able to create its databases correctly. If your model database is smaller than 3MB the system will not function.

If SQL Server is already installed and has been configured with a different model database size, change the size in the following way:

-
- Step 1** Launch SQL Management Studio.
 - Step 2** Connect to the database.
 - Step 3** Expand **Parent > Databases > System Databases**.
 - Step 4** Right-click **Model**, and then select **Properties**.
 - Step 5** In the left navigation pane, select **Files**.
 - Step 6** Change the **Initial Size** of **modeldev** to **3**.
 - Step 7** Click **OK**.
 - Step 8** Close SQL Management Studio.
 - Step 9** Relaunch the Cisco Unified Attendant Console Advanced installer and proceed with installation.
-

System Hardening

To ensure system security, your operating system and SQL installations must be configured according to your company's system hardening guidelines. Make sure that all specific configuration requirements for Cisco Unified Attendant Console Advanced are still met after hardening.



Cisco Unified Attendant Console Advanced Architecture

This chapter describes:

- [System Architecture Overview](#)
- [CTI Architecture](#)— CTI request information flow and CTI setup
- [Call Flow Diagrams](#)—for standard and transferred calls
- [Centralized Installations and Transcoding](#)—networks that require transcoding
- [Network Bandwidth Consumption](#)—system requirements to assist network planning
- [Sample Topologies](#)—port numbers and their functions.
- [AXL Connectivity](#)—when AXL is used and when the AXL service needs to run.
- [Cisco Unified Attendant Console Advanced Web Administration](#)

System Architecture Overview

The Cisco Unified Attendant Console Advanced system comprises several services that run on a single physical or virtual Windows server. Two servers can be run simultaneously to provide a resilient solution, with one server acting as a hot standby for the other. The system requirements are described in *Cisco Unified Attendant Console Advanced Administration and Installation Guide*.

The necessary services are:

Service	Description
Cisco Unified Attendant Console Advanced server	This is the engine of the system and it controls the system configuration. It is also the service that the Clients connect to.
Cisco Unified Attendant BLF Plug-in	This handles all communications requests between the Cisco Unified Attendant Console Advanced system and the Cisco Unified Communications Manager system. This includes communication to the Cisco TSP installed on the Cisco Unified Attendant Console Advanced server, all CTI requests, and AXL communication, enabling the system to request information from the correct Cisco Unified Communications Manager. The BLF Plug-in uses information from the main configuration database to control how it functions.

Service	Description
Cisco Unified Attendant LDAP Plug-in	This handles all directory synchronization requests via LDAP to the Cisco Unified Communications Managers being used.
Cisco Unified Attendant Presence Plug-in	This provides direct connection to a Cisco CUP server to obtain the relevant presence information for contacts.

All these services are installed by a single installation script.

Cisco Unified Attendant Console Advanced also uses the Microsoft Active MQ service, which enables the two servers of a resilient installation to communicate with each other. This service is also installed during Cisco Unified Attendant Console Advanced installation.

Also required on the Cisco Unified Attendant Console Advanced server are SQL Server and Cisco TSP. Up to ten instances of Cisco TSP can run simultaneously, each configured with its own Primary and Secondary CTI Manager Connections, to enable for system resilience if there is a primary node CTI Manager failure. Each instance requires a unique Application User profile, which defines the instance's roles and permissions.

Cisco CTI Manager is a service that runs on one or more Cisco Unified Communications Manager subscriber servers operating in primary/secondary mode. It authenticates and authorizes telephony applications to control and/or monitor Cisco IP devices.

For more information about Cisco TSP, see [Configuring CTI Manager and Cisco TSP, page 3-11](#). For more information about SQL Server, see [Chapter 6, “Directory Contacts, Devices and Line Status”](#).

The following diagram shows the basic elements of a Cisco Unified Attendant Console Advanced system.

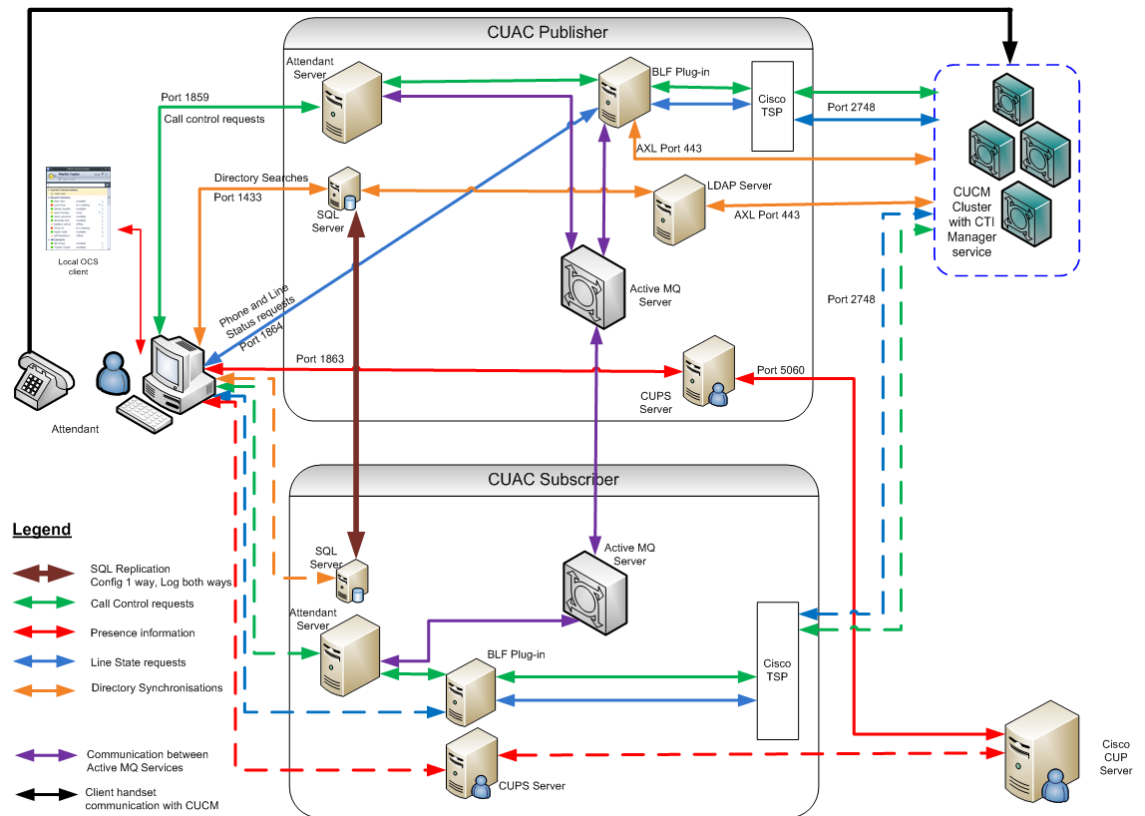

The server components all reside on the machine known as the Cisco Unified Attendant Console Advanced server. The Clients connect to the Cisco Unified Attendant Console Advanced attendant server over port 1859 for all call control communications. Other ports are used for other elements. For a full list of IP ports used by Cisco Unified Attendant Console Advanced, see [Sample Topologies, page 2-19](#).

Cisco Unified Attendant Console Advanced supports IPsec should you need to encrypt its network traffic.

Bandwidth and Latency

Communication critical to Cisco Unified Attendant Console Advanced are the messages between the server and the Clients (attendants). Cisco Unified Attendant Console Advanced supports a maximum latency of 150ms Round Trip Time (RTT) between any Client and the server, and you should ensure that this is achievable in your network.

The maximum RTT for communication between the Cisco Unified Attendant Console Advanced Publisher and Subscriber is 150ms. The maximum RTT for TAPI communication between Cisco Unified Attendant Console Advanced and Cisco Unified Communications Manager is 80ms.

For more information, see the Cisco Solution Reference Network Design.

Cisco TSP Timeouts

Cisco recommends that your TSP instances have the **Provider Open Completed Timeout** set to 300 seconds, rather than the default value of 50 seconds. This gives the TSP more time to register the system devices being used for the Cisco Unified Attendant Console Advanced server. If insufficient time is allowed, devices may fail to monitor correctly and this will affect the stability of the system.

To configure the timeout, do the following:

-
- Step 1** Launch Cisco TSP Configuration.
 - Step 2** Select the instance, and then click **Configure**.
 - Step 3** Select the **Advanced** tab.
 - Step 4** In **Provider Open Completed Timeout (secs)**, type 300.
 - Step 5** Click **OK**.
 - Step 6** Restart the server.
-

Cisco TSP Updates

We recommend that you install Cisco TSP updates during planned maintenance windows, as they will be service-impacting.

Cisco Unified Attendant Console Advanced does not support Cisco TSP Auto Updates. Updates executed during production will take your server offline and could potentially corrupt the Cisco TSP installation.

CTI Architecture

Cisco Unified Attendant Console Advanced provides call control and device monitoring via CTI connections between the Cisco Unified Attendant Console Advanced server and the Cisco Unified Communications Manager cluster. The Cisco Unified Attendant Console Advanced server sends call control requests via this interface, and the Cisco Unified Communications Manager acts upon those requests, returning confirmation messages when the action is complete. This interaction uses Cisco TSP, which is installed on the Cisco Unified Attendant Console Advanced server (as part of the Cisco Unified Attendant Console Advanced server installation), and which communicates with the CTI Manager service on the Cisco Unified Communications Manager. To increase CTI resources, you can install up to 10 TSP instances on a single server, but the Cisco Unified Attendant Console Advanced server cannot communicate with any specific instance.

It is important that you include your CTI requirements into the overall Cisco Unified Communications Manager design. At least one Cisco Unified Communications Manager node must have CTI Manager service enabled. If you require it, you can request that the CTI Manager service is activated on each Cisco Unified Communications Manager node in the cluster.

CTI Request Information Flow

The following diagram illustrates how information flows from the attendant Client through to the Cisco Unified Communications Manager, which actually routes the calls.

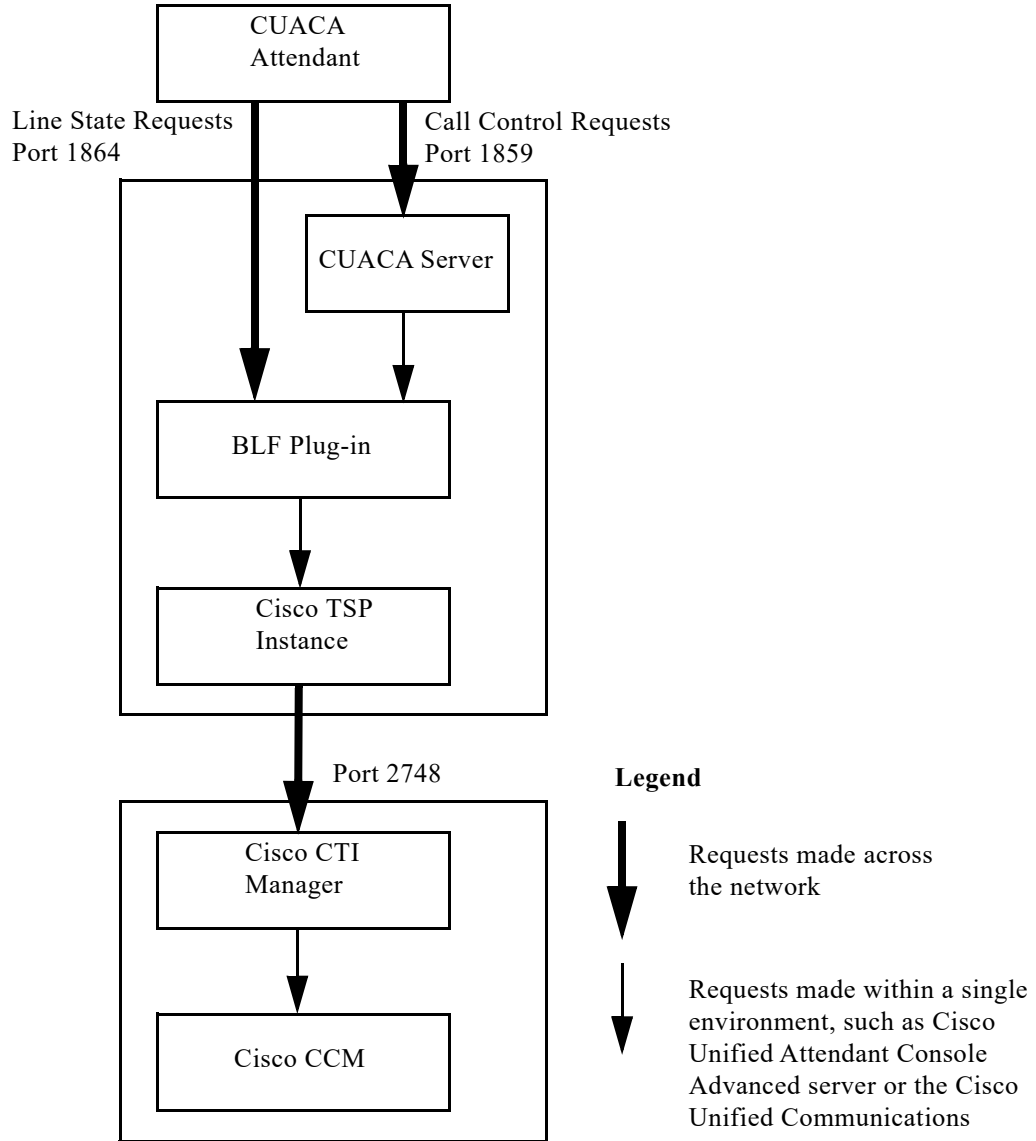

For CTI applications that require redundancy, each TSP instance can be configured with two IP addresses, thereby enabling an alternate CTI Manager to be used in the event of a failure.



Note

This redundancy is not stateful: no information is shared or made available between the two CTI Managers, and therefore, after a failover, the CTI application may have to re-initialize, depending on the type of failover.

If a CTI Manager fails-over, just the CTI application login process is repeated on the now-active CTI Manager.

If the Cisco Unified Communications Manager server itself fails, the re-initialization process is longer due to the re-registration of all the devices from the failed Cisco Unified Communications Manager to the now-active Cisco Unified Communications Manager, followed by the CTI application login process.

Cisco CTI consists of the following components, which interact to enable applications to take advantage of the Cisco Unified Communications Manager telephony feature set:

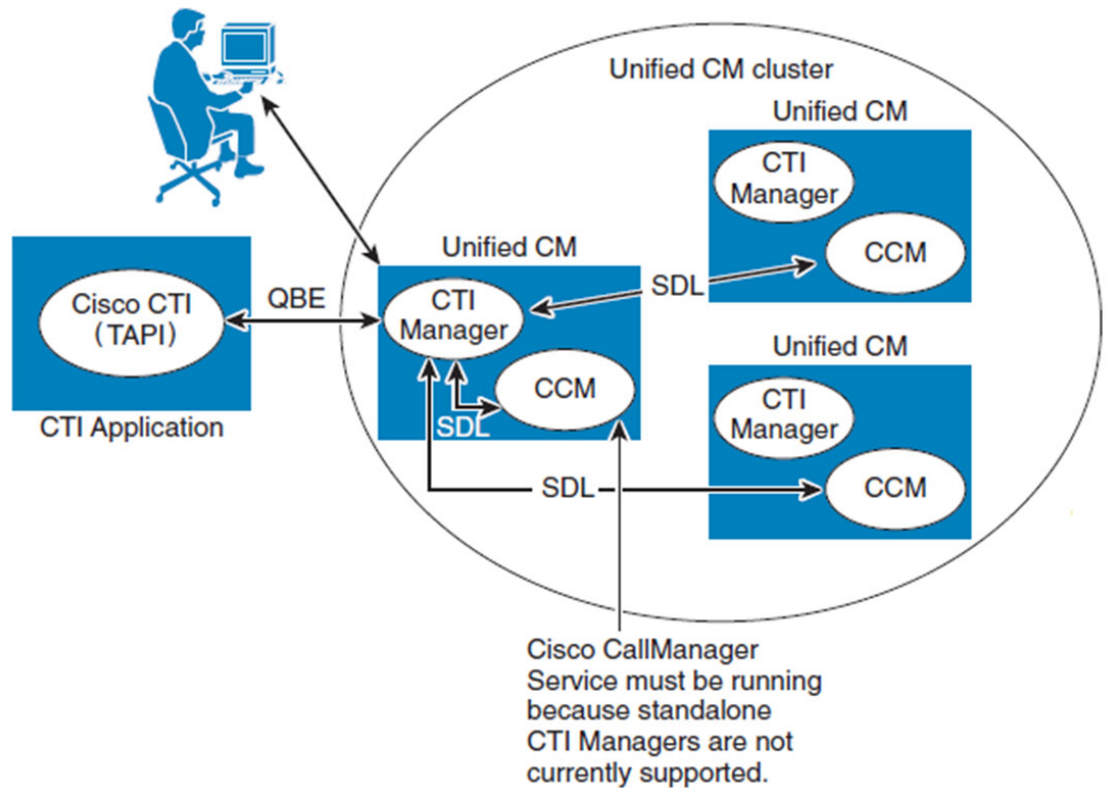

- CTI Application - Cisco or third-party application that provides telephony features and/or functionality. It uses the TAPI interface, which are supported by Cisco CTI. Developers can use either method library when writing applications. The Unified TSP Client converts external messages to Quick Buffer Encoding (QBE) messages used internally by Cisco Unified Communications Manager.
- CCM - Cisco CallManager Service (ccm.exe), the telephony processing engine.
- CTI Manager - A service that runs on one or more Cisco Unified Communications Manager subscriber servers operating in primary/secondary mode, and which authenticates and authorizes telephony applications to control and/or monitor Cisco IP devices.
- Signaling Distribution Layer (SDL) - Cisco Unified Communications Manager internal communication messages.

Cisco Unified Attendant Console Advanced CTI Setup

This section describes how to set up CTI for Cisco Unified Attendant Console Advanced to function correctly.

TSP must be configured and active on each Cisco Unified Attendant Console Advanced server before the server can start.

CTI Resilience

The Cisco Unified Attendant Console Advanced servers can be configured to use multiple TSP instances, providing them with a Backup CTI Manager should the Primary fail. This resilience is configured in the TSP itself.

This section describes some configurations.

Standalone Cisco Unified Attendant Console Advanced Server

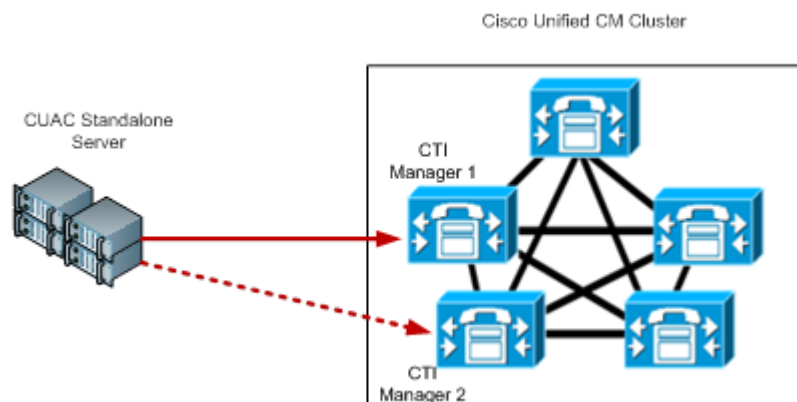

This example has a single, standalone Cisco Unified Attendant Console Advanced server, and a five node Cisco Unified Communications Manager cluster with two nodes running the CTI Manager service. The Cisco Unified Attendant Console Advanced server is running a single TSP instance with a Primary connection to CTI Manager 1 and a Backup connection to CTI Manager 2.

Resilient Cisco Unified Attendant Console Advanced Servers On a Small Cisco Unified Communications Manager Cluster

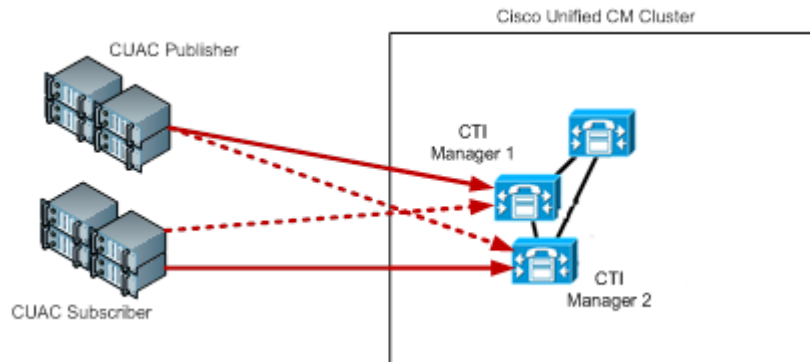

This example has only three nodes in the Cisco Unified Communications Manager cluster, the top node is the Publisher (primary) server and the lower two are Subscriber (secondary) servers. We recommended you do not use the CTI Manager on the Publisher node, therefore both Cisco Unified Attendant Console Advanced servers should use the CTI Managers on the two Subscribers, and should balance the load as best they can. Each server should use a different CTI Manager as the primary connection, and then fail over to the other node.

Resilient Cisco Unified Attendant Console Advanced Servers On a Large Cisco Unified Communications Manager Cluster

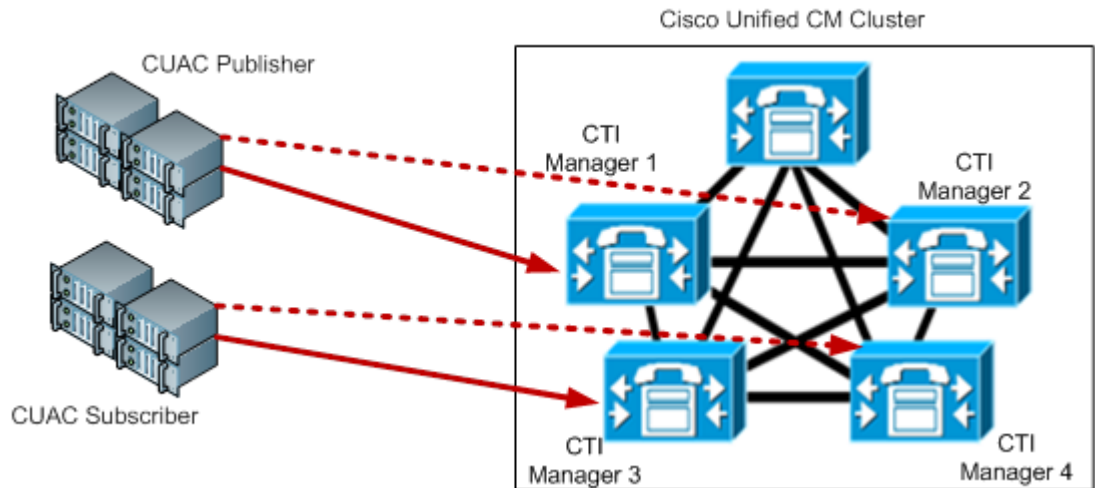

This example provides complete CTI redundancy. Each Cisco Unified Attendant Console Advanced server is configured with a single TSP instance that has primary and backup connections. To spread the load completely four of the CTI Managers in the cluster are used, with each Cisco Unified Attendant Console Advanced server using unique primaries and backups.

Call Flow Diagrams

This section contains the following call flow diagrams:

- [Standard Call Flow Within Cisco Unified Attendant Console Advanced](#), Figure 2-1
- [Call Flow During Blind Transfer](#), Figure 2-2 on page 2-10
- [Call Flow During Consultation Transfer](#), Figure 2-3 on page 2-11
- [Call Flow During Campon of Calling Party A to Called Party B](#), Figure 2-4 on page 2-12

Figure 2-1 *Standard Call Flow Within Cisco Unified Attendant Console Advanced*

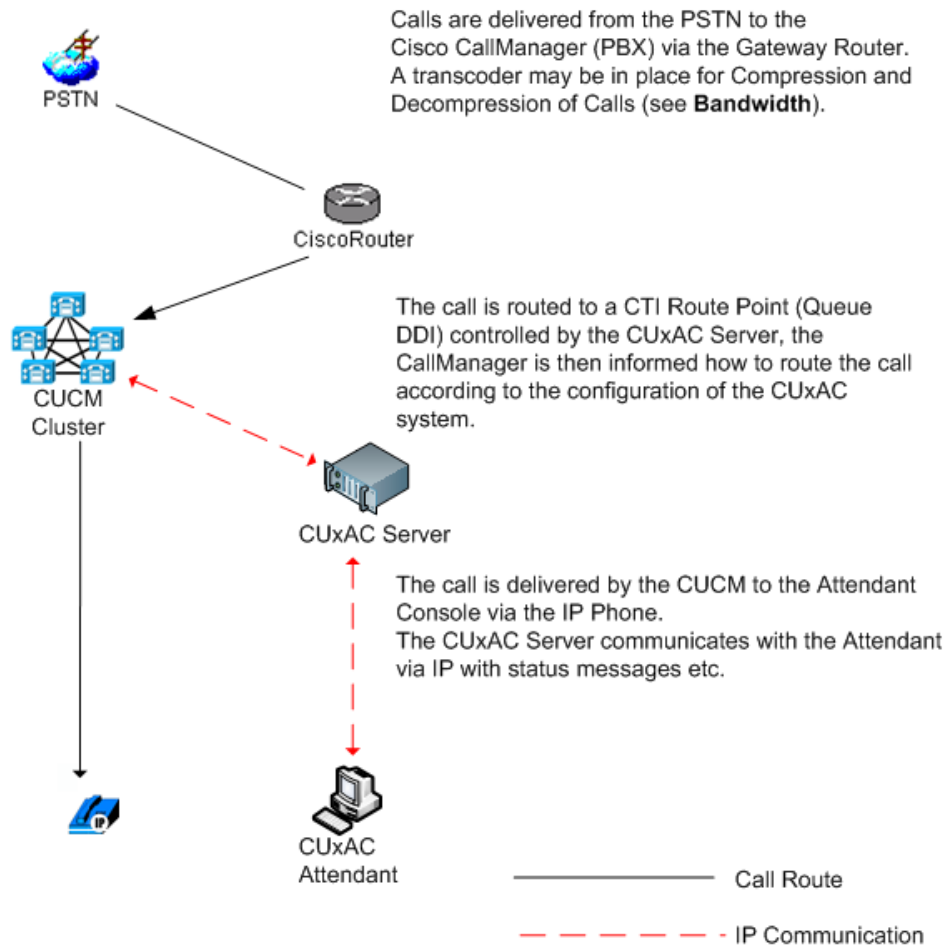

Figure 2-2 Call Flow During Blind Transfer

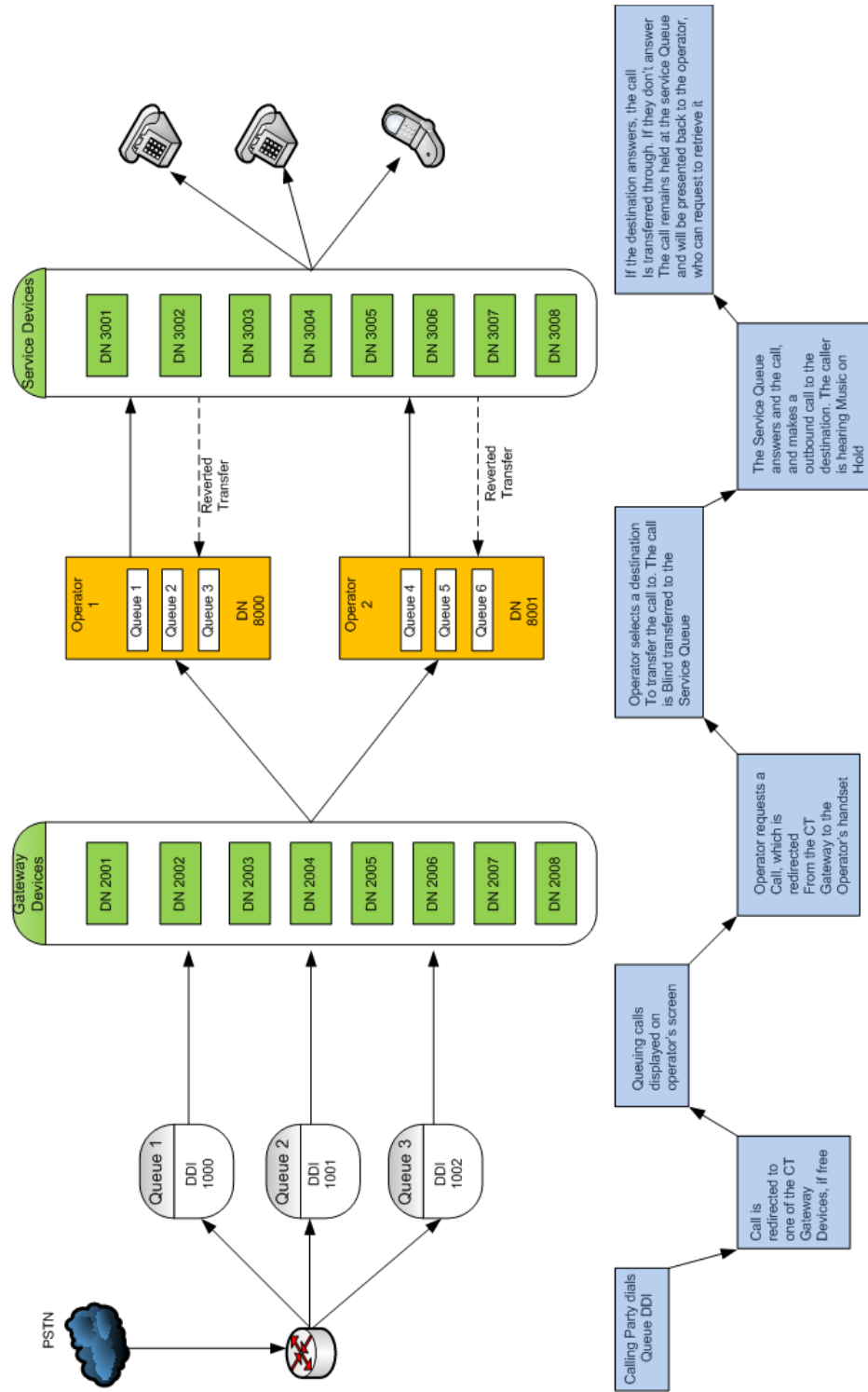

Figure 2-3 Call Flow During Consultation Transfer

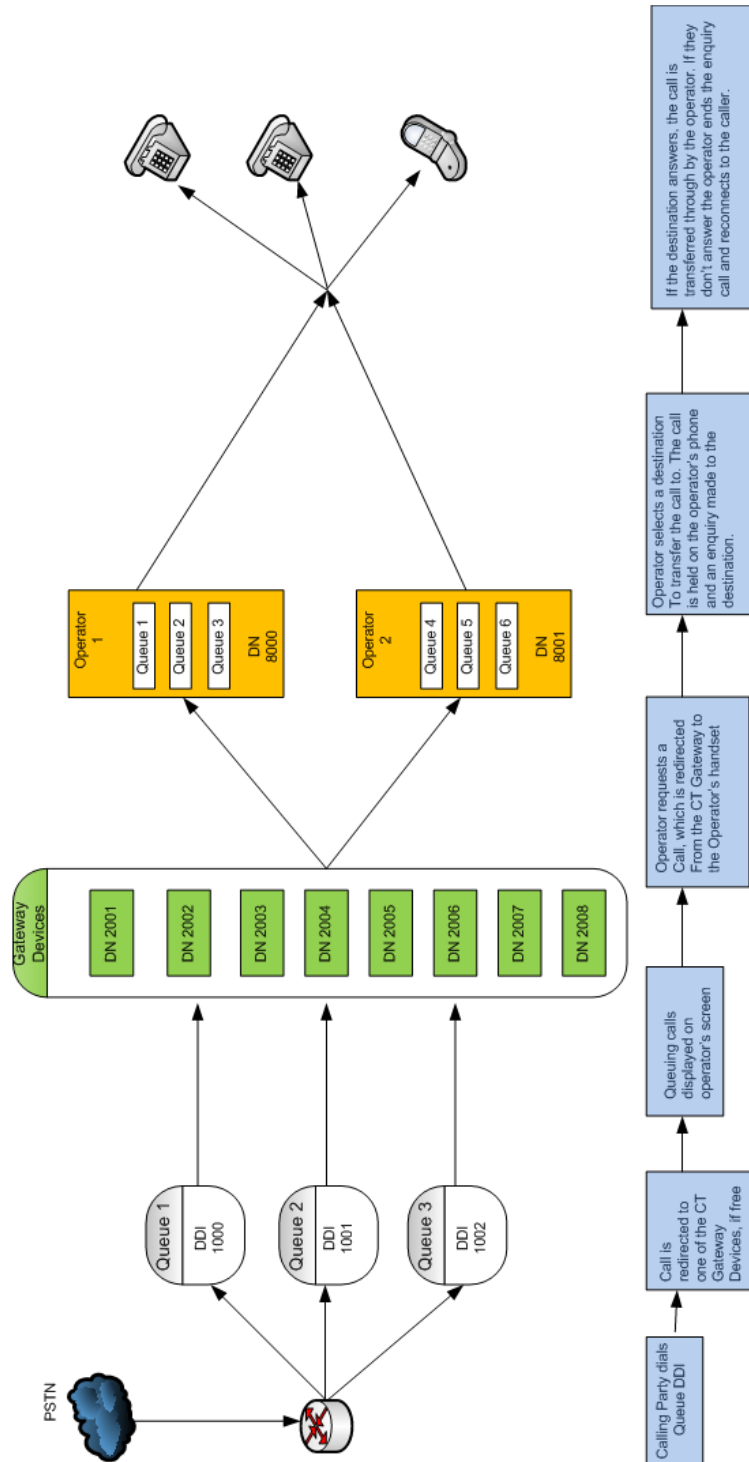
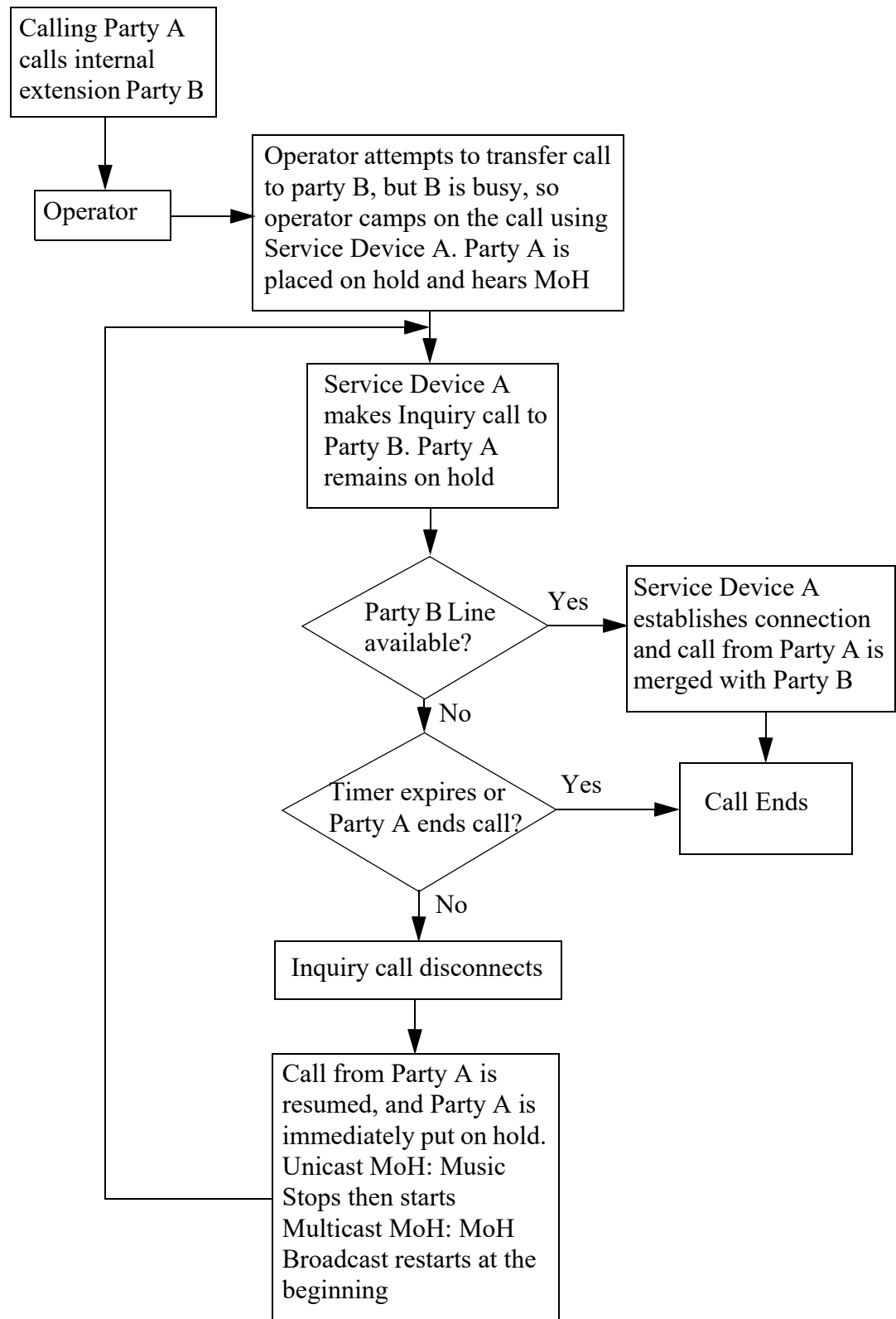

Figure 2-4 Call Flow During Campon of Calling Party A to Called Party B



Centralized Installations and Transcoding

In a centralized environment where the G729 codec is being used across WAN links, a transcoder must be installed wherever the Cisco Unified Attendant Console Advanced server is located. This means that when a call crosses the WAN link to an attendant's IP Phone as a G729 call, during any subsequent call transfer, hold or park, Cisco Unified Communications Manager changes the codec to G711 while the call is connected to the Service Queue or Call Park Device CTI Ports.

To support G729 natively with the New Media Driver you need to do the following:

- On the Cisco Unified Attendant Console Advanced server, change the registry key HKEY_USERS/S-1-5-20/Software/Cisco Systems, Inc./RTPLib/G729PassThrough to 1 in either Hex or Dec, and then reboot the server.
- Ensure that the Device Pool and the region in which the CTI Port(s) are assigned is *not* restricted to G729. If it is, calls will not be processed correctly, and will be unable to be redirected to the CTI Port.

For more information on transcoding refer to the Cisco Solution Reference Network Design.

Example Installation Requiring Transcoding

This example describes a call being received by a system with centrally-located Cisco Unified Communications Manager and Cisco Unified Attendant Console Advanced server, and an attendant at a remote location, connected across the WAN. This scenario requires transcoding, as does any other involving the call being transferred, parked, or camped-on.

Figure 2-5 Call Enters System

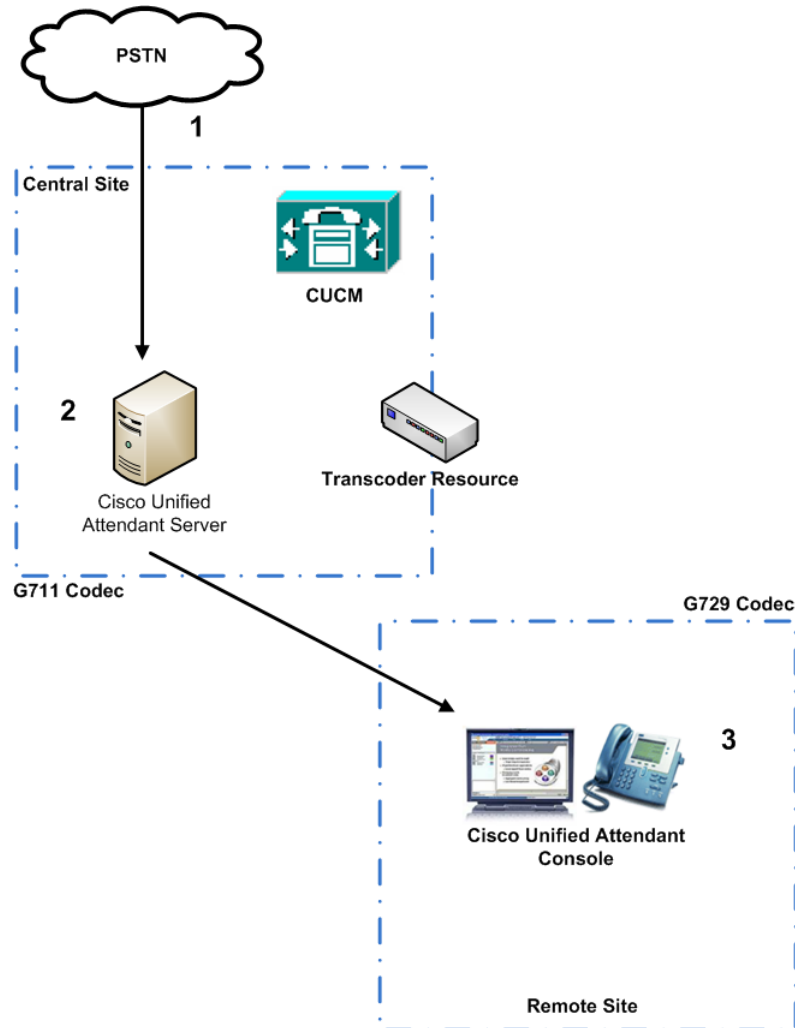

1. The call is received from an external telephone network.
2. The call is routed from the Queue DDI to the CT Gateway CTI Port.
3. The Cisco Unified Attendant Console Advanced Client can now see the call in the queue. The call is ringing on the CT Gateway and is in the queue waiting to be answered. The CT Gateway devices are registered to the Cisco Unified Communications Manager in the central site.

Figure 2-6 Remote Attendant Requests Call

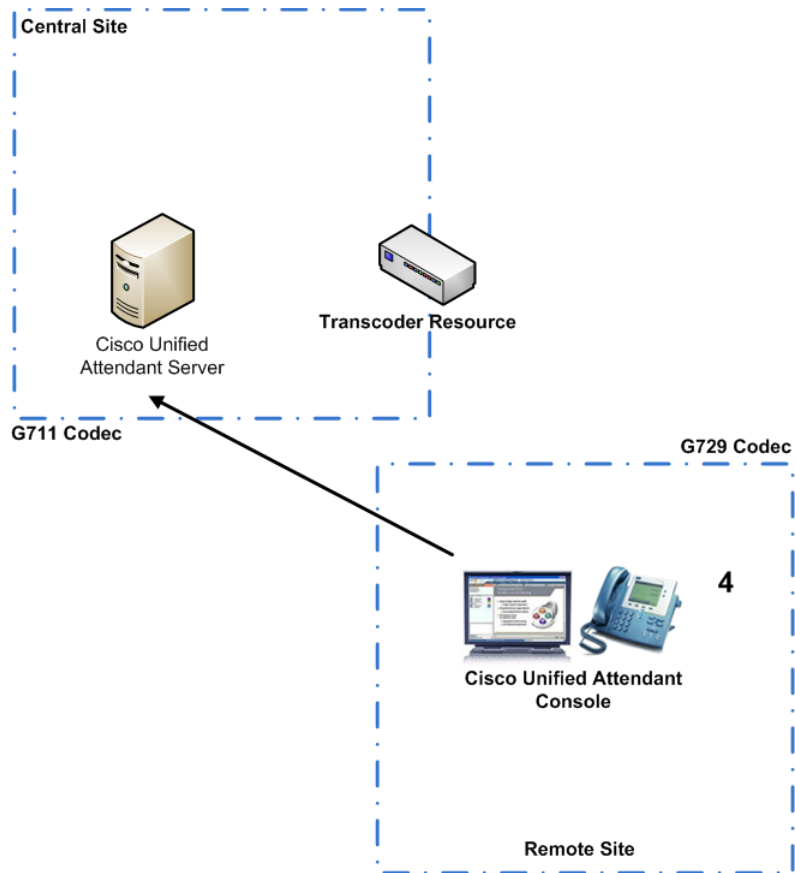

4. The Cisco Unified Attendant Console Advanced requests the call, which is delivered to the attendant extension in the remote site.

Figure 2-7 Cisco Unified Attendant Console Advanced Answers

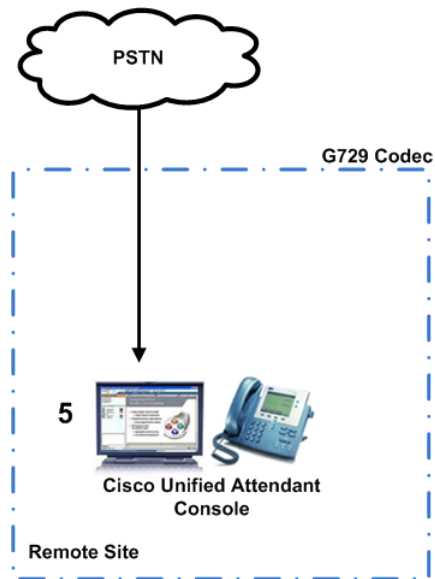

5. The Cisco Unified Attendant Console Advanced is talking to the caller. Because the attendant is on the remote site, the call is established using the G729 codec.

Figure 2-8 Cisco Unified Attendant Console Advanced Puts Call on Hold

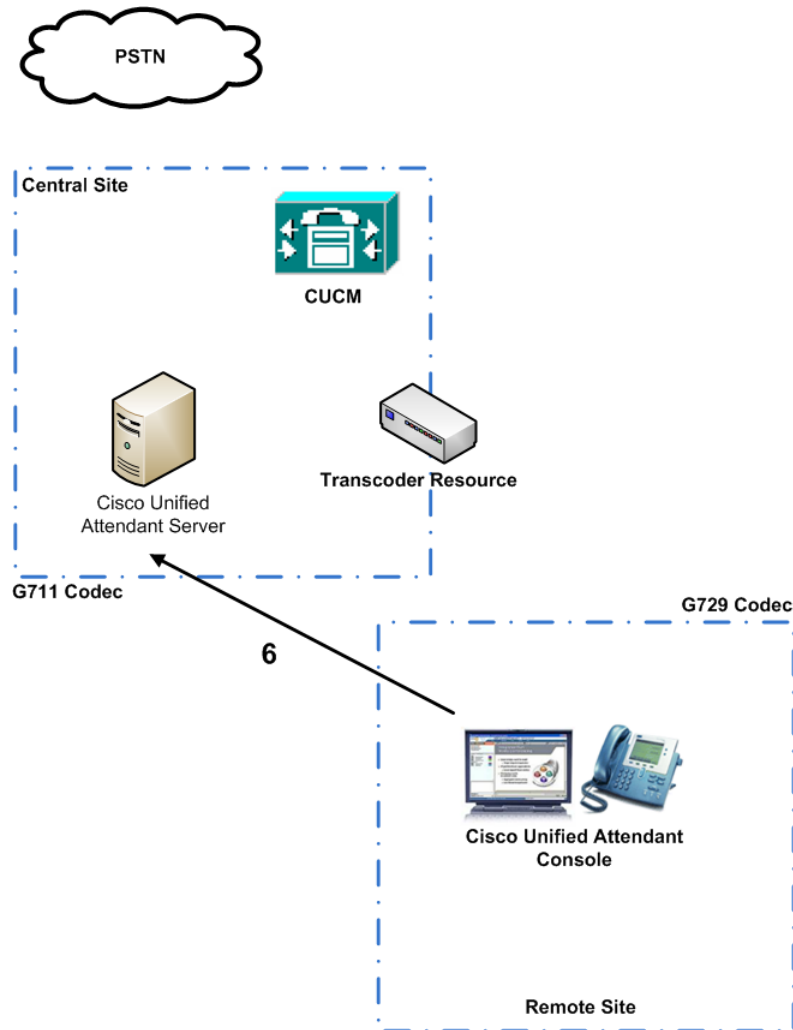

6. The Cisco Unified Attendant Console Advanced requests that the call be put on hold—the call is redirected back to the Cisco Unified Attendant Console Advanced server to be put on hold on a Service Queue Device (CTI Port). The transcoder must now convert the call back to the G711 codec so that the Wave enabled CTI Port can accept the call. If the call is still G729 when it reaches the Service Queue, the Cisco Unified Communications Manager will disconnect the call.

Network Bandwidth Consumption

You can implement location-based Call Admission Control to restrict bandwidth usage across the WAN, with maximum bandwidths set for calls to and from each remote location.

To ensure that devices are not subject to bandwidth restrictions, when you create controlled CTI devices, set their location to None. If you do set locations, bandwidth will be allocated according to the Region settings and the codec used between the endpoints:

- Calls across a LAN typically use the G711 or G722 codec (depending on the phone type), with each call using up to 80Kb/sec of bandwidth.
- Calls across a WAN may use the G729 codec, with each call using 24Kb/sec of bandwidth. If you use other codecs to reduce the bandwidth further, you may need a transcoder, as described in [Centralized Installations and Transcoding, page 2-13](#).

**Note**

Latency - A maximum round trip time (RTT) of 150ms should be ensured to enable provision for optimum network performance. For more information, see [Bandwidth and Latency, page 2-3](#).

The following IP communications between the Cisco Unified Attendant Console Advanced server and the Console Attendant also consume bandwidth:

- Contact Searching—Each search of the Contact Directory returns matches from the SQL database. The bandwidth consumption depends on:
 - Number of contacts returned
 - Amount of data in each contact
 - Number of operators searching simultaneously

Bandwidth consumption varies between 4Kb and 22KB per contact.

- Database Synchronization—The bandwidth consumption depends on:
 - Number of contacts returned
 - Amount of data in each contact

Bandwidth consumption is about 9Kb per contact.

Sample Topologies

This section contains diagrams of the following sample topologies:

- [Single Site Topology, page 2-19.](#)
- [Centralized Cisco Unified Attendant Console Advanced Server with Local and Remote Clients, page 2-20.](#)

Single Site Topology

In the example shown below, the Cisco Unified Attendant Console Advanced server and Cisco Unified Attendant Console Advanced Client machines are on the same LAN as the Cisco Unified Communications Manager servers. There are no remote Cisco Unified Attendant Console Advanced Clients, or IP Phones.

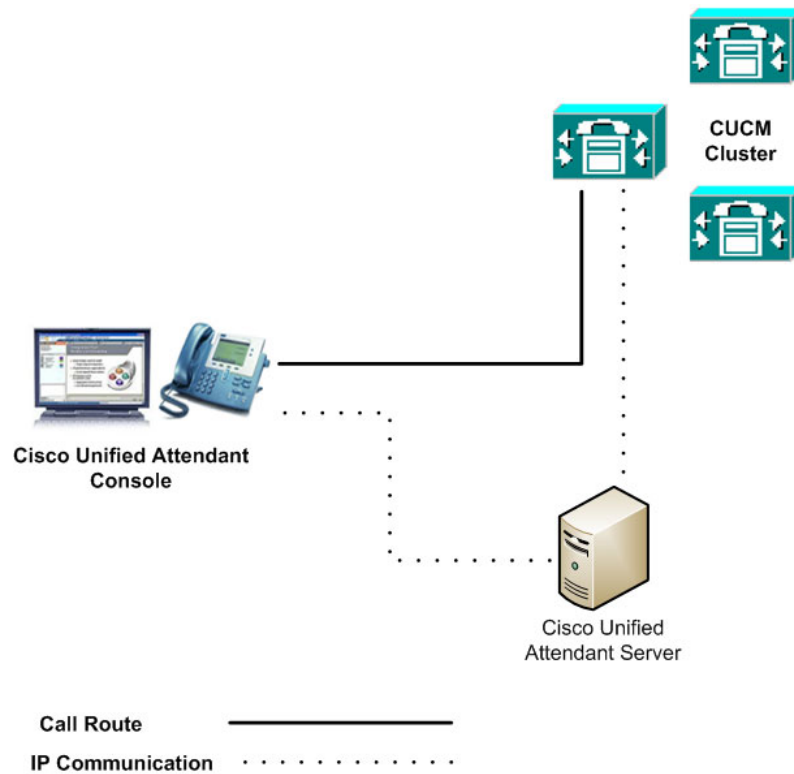

In this scenario resilience is configured using Call Forward No Answer to a Pilot Point Group, IP Phone or other device outside of the Cisco Unified Attendant Console Advanced environment.

Centralized Cisco Unified Attendant Console Advanced Server with Local and Remote Clients

In the example shown below, the Cisco Unified Attendant Console Advanced server and some Cisco Unified Attendant Console Advanced Client machines are on the same LAN as the Cisco Unified Communications Manager servers. Some Client machines are also on a remote site that uses G729.

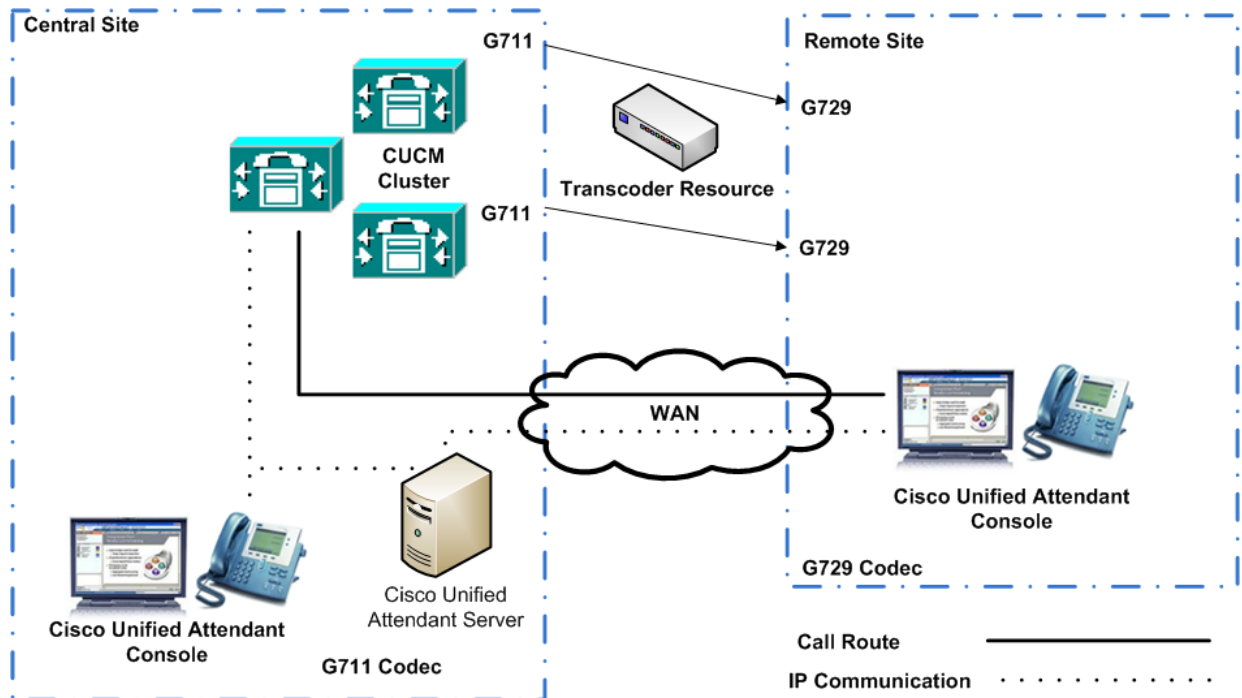

This topology has the following characteristics:

Resilience is configured using Call Forward No Answer to a Pilot Point Group, IP Phone or other device.

Because the TAPI wave method is being used and the G729 codec is being used at the remote site, a transcoder is installed at the central site, where the Cisco Unified Communications Manager is located and the CTI Ports are registered. When a Client at the remote site handles the call, it uses G729, but when the call is routed to the central site, it is changed to G711.

AXL Connectivity

The AVVID XML Layer (AXL) is used both during and after Cisco Unified Attendant Console Advanced installation.

AXL Usage During Installation

During Cisco Unified Attendant Console Advanced server installation (both standalone and resilient) you have to specify the following nodes:

- The Cisco Unified Communications Manager (CUCM) that will use it (see Step 14 of the Installation Procedure in the *Cisco Unified Attendant Console Advanced Administration and Installation Guide*). In resilient installations the Publisher and Subscriber servers both need this information. Specify the CUCM IP address / Host name so that the CTI server can use AXL to dynamically resolve devices for operator login and collect BLF status information. You can provide only one CUCM IP address / Host name.
- The Primary and Backup *CTI Manager* that will use it (see Step 16 of the Installation Procedure in the *Cisco Unified Attendant Console Advanced Administration and Installation Guide*). CTI Manager is a feature service that runs on one or more Cisco Unified Communications Manager subscribers operating in primary/secondary mode to authenticate and authorize Cisco Unified Attendant Console Advanced. A *CTI Manager node* is a Cisco Unified Communications Manager subscriber that runs only the CTI Manager service. Cisco TSP connects Cisco Unified Attendant Console Advanced server to the primary/backup CTI Managers, which can be on different machines.

The Cisco Unified Attendant Console Advanced server installer uses AXL to verify that the specified CTI manager(s) and Cisco Unified Communications Manager versions match, which is essential for successful implementation.

AXL Usage After Installation

Part of the Cisco Unified Attendant Console Advanced BLF Plug-in service known as Device Resolution Manager (DRM) uses AXL to communicate with Cisco Unified Communications Manager. The AXL communications enable DRM to resolve the BLFs of operator and system devices, and to synchronize system devices within the Cisco Unified Communications Manager database.

After Cisco Unified Attendant Console Advanced is installed, the CTI Manager nodes no longer require the AXL service; so you can disable it. However, if the main Cisco Unified Communications Manager node and the CTI Manager nodes are hosted on the same servers, you need to retain the AXL service on them. Usually, the CUCM IP / Host for AXL and the Primary CTI Manager are the same. If the Primary CTI Manager fails, CTI resilience will work, but AXL communications are not redirected to the backup CTI Manager.

Primary CTI Manager failure is caused by either:

- The CTI Manager service of the primary CUCM is down; the other services, including AXL, are still working.

A standalone CUACA in this scenario, is resilient, and everything should continue to work, because the CTI Server will still be able to reach the CUCM IP / Host for AXL-based device resolution, and Cisco TSP will continue to work using the backup CTI server.

- The primary CUCM is no longer reachable. The CTI Server will be unable to resolve the devices using AXL, even when Cisco TSP is working properly. If an operator tries to log in using a device that is not statically assigned to the Cisco TSP user - and is also not already resolved by CTI server

dynamically - the login will fail. Furthermore, BLF will not be available during this failover. In a standalone CUACA setup, we cannot provide a secondary CUCM IP / Host for AXL connectivity so we do not have any resilience.

Standalone Installation Scenarios

This section describes AXL usage in example standalone Cisco Unified Attendant Console Advanced server installations.

Scenario 1

This scenario uses the following node IP addresses:

- Cisco Unified Communications Manager = 172.29.252.111
- Primary CTI Manager = 172.29.252.111
- Backup CTI Manager = 172.29.252.112

DRM uses only the Cisco Unified Communications Manager at 172.29.252.111. Consequently, the AXL service can be disabled on 172.29.252.112 after installing Cisco Unified Attendant Console Advanced.

Scenario 2

This scenario uses the following node IP addresses:

- Cisco Unified Communications Manager = 172.29.252.111
- Primary CTI Manager = 172.29.252.112
- Backup CTI Manager = 172.29.252.113

DRM uses only the Cisco Unified Communications Manager at 172.29.252.111. Consequently, the AXL service can be disabled on 172.29.252.112 and 172.29.252.113 after installing Cisco Unified Attendant Console Advanced.

Resilient Installation Scenarios

This section describes AXL usage in example resilient Cisco Unified Attendant Console Advanced server installations.

Scenario 3

This scenario uses the following node IP addresses:

- Publisher Cisco Unified Communications Manager = 172.29.252.111
- Publisher Primary CTI Manager = 172.29.252.111
- Publisher Backup CTI Manager = 172.29.252.112
- Subscriber Cisco Unified Communications Manager = 172.29.252.111
- Subscriber Primary CTI Manager = 172.29.252.111
- Subscriber Backup CTI Manager = 172.29.252.112

DRM uses the Cisco Unified Communications Manager pointed to by both Publisher and Subscriber Cisco Unified Attendant Console Advanced servers (both 172.29.252.111). Consequently, the AXL service can be disabled on 172.29.252.112 after installing Cisco Unified Attendant Console Advanced.

Scenario 4

This scenario uses the following node IP addresses:

- Publisher Cisco Unified Communications Manager = 172.29.252.111
- Publisher Primary CTI Manager = 172.29.252.111
- Publisher Backup CTI Manager = 172.29.252.112
- Subscriber Cisco Unified Communications Manager = 172.29.252.112
- Subscriber Primary CTI Manager = 172.29.252.111
- Subscriber Backup CTI Manager = 172.29.252.112

DRM uses the Cisco Unified Communications Manager pointed to by both Publisher and Subscriber Cisco Unified Attendant Console Advanced servers (172.29.252.111 and 172.29.252.112). Consequently, we need AXL connectivity to both IP addresses, and cannot disable AXL service on either.

Scenario 5

This scenario uses the following node IP addresses:

- Publisher Cisco Unified Communications Manager = 172.29.252.111
- Publisher Primary CTI Manager = 172.29.252.111
- Publisher Backup CTI Manager = 172.29.252.113
- Subscriber Cisco Unified Communications Manager = 172.29.252.112
- Subscriber Primary CTI Manager = 172.29.252.111
- Subscriber Backup CTI Manager = 172.29.252.113

DRM uses the Cisco Unified Communications Manager pointed to by both Publisher and Subscriber Cisco Unified Attendant Console Advanced servers (172.29.252.111 and 172.29.252.112). Consequently, the AXL service can be disabled on Cisco Unified Communications Manager IP 172.29.252.113 after installing Cisco Unified Attendant Console Advanced.

Cisco Unified Attendant Console Advanced Web Administration

Web Administration is accessible at:

- <https://<ip address of Cisco Unified Attendant Console Advanced server>/WebAdmin/login.aspx>
- <https://<hostname of Cisco Unified Attendant Console Advanced server>/WebAdmin/login.aspx>

Web Administration is configured with a self-signed certificate at installation. Custom certificates can be deployed as required.

Detailed instruction regarding Web Administration is available in the *Administration and Installation Guide*.



Note

The Cisco Unified Attendant Console Advanced server is configured with redirect rules. The rule that redirects HTTP addresses to HTTPS may cause some security scanning utilities to deliver false positive results. Many scanning utilities alert if an HTTP address does not present a 404 error page. With the redirect in place, instead of presenting users with a 404 error page, they are routed to the Web Administration login page. These alerts should be dismissed, as Cisco Unified Attendant Console Web Administration requires an HTTPS connection.



Cisco Unified Communications Manager Compatibility

Cisco Unified Attendant Console Advanced Releases only support specific Cisco Unified Communications Manager Releases. To check whether your Cisco Unified Attendant Console Advanced and Cisco Unified Communications Manager are compatible, see the [Release Notes](#).

This chapter covers the following:

- [Calling Search Spaces and Partitions](#)
- [Configuring Controlled CTI Devices](#)
- [Configuring CTI Manager and Cisco TSP](#)
- [Supported Handsets](#)

Calling Search Spaces and Partitions

Calling Search Spaces (CSS) and partitions are used within Cisco Unified Communications Manager to control the calling abilities of the devices in the system. The architecture of the Cisco Unified Attendant Console Advanced system demands that incoming calls can be transferred to all the devices that could possibly be required - not just internal transfers but potential external-to-external transfers as well.

Cisco Unified Attendant Console Advanced moves calls from one device to the next using the `lineBlindTransfer` method, where the CSS of the call changes as it progresses through the system, according to the *transferring* device. Consequently, Cisco Unified Attendant Console Advanced CTI Route Points and CTI Ports need to have all the relevant CSSs and partitions assigned to enable them to receive and then transfer the call. Under the default Cisco Unified Attendant Console Advanced installation, Service Queue Ports must be able to call any destination to which any attendant may wish to transfer a call. If Direct Transfer is being used, it is the attendant's line that needs to be able to call any destination. We recommend that a separate partition and CSS be created for the System Devices.

The attendant Client IP phones do not need to have the same CSS and partition as the controlled CTI devices. However, they must be able to receive incoming calls from the Host PBX Gateways devices and from the Service Queue devices where calls return unanswered. The attendant Client IP phones also need to be able to dial both the Service Queue and any other destinations to which they may transfer calls. The Service Queue devices must, in turn, be able to dial the attendant's handset and all other destinations for transfers.

The remainder of this section describes some of the most common call routing scenarios, and how CSSs enable Cisco Unified Attendant Console Advanced to function correctly.

Answering Calls

This scenario describes a call being answered.

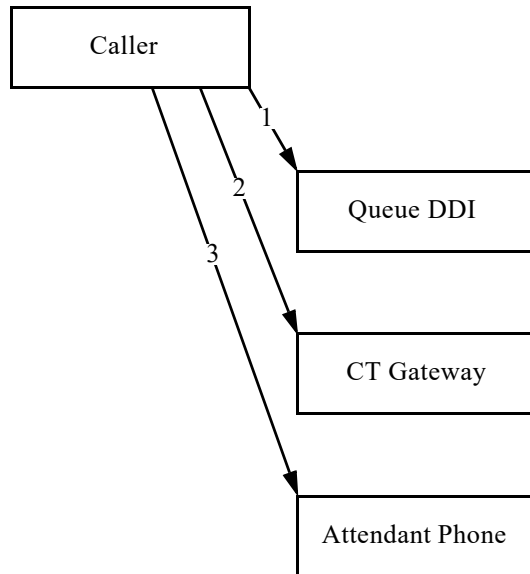

1. Call arrives at the Queue DDI device. This notifies Cisco Unified Attendant Console Advanced that the call has arrived for the specified queue, and allows for CLI filter checking. The CSS of the CTI Route Point (Queue DDI) is now being used.
2. Call is routed to the pool of CT Gateway devices, based on the Queue Device Group of the Pre CT Gateway. The call is now being made from the originating point to the CT Gateway. The CSS changes from that of the originating point to that of the CT Gateway port.
3. The attendant chooses to answer the call or the call is delivered by forced delivery. The call is routed from the CTI Port to the attendant's phone. They are now connected to the original caller.



Tip

If a call is displayed in the attendant console (F8) but does not move the attendant's phone when they try to answer it, check the CSS for the CT Gateway port. Does it contain the attendant phone's partition?

Consult Transfer

This scenario describes a call being answered and then consult transferred to a destination.

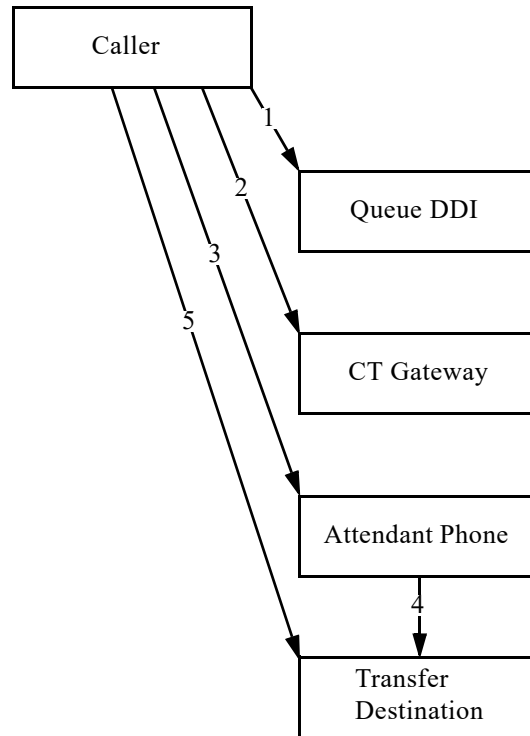

1. Call arrives at the Queue DDI device. This notifies Cisco Unified Attendant Console Advanced that the call has arrived for the specified queue, and allows for CLI filter checking. The CSS of the CTI Route Point (Queue) is now being used.
2. Call is routed to the pool of CT Gateway devices, based on the Queue Device Group of the Pre CT Gateway. The call is now being made from the originating point to the CT Gateway. The CSS changes from that of the originating point to that of the CT Gateway port.
3. The attendant chooses to answer the call or the call is delivered by forced delivery. The call is routed from the CTI Port to the attendant's phone. They are now connected to the original caller. The call now takes the CSS of the attendant's line/phone.
4. The attendant dials the destination for the consult transfer, using the CSS of the attendant's line/phone, as with any other call or transfer made using the IP handset.
5. When the end party answers the call, the transfer connects the original caller with the transfer destination.



Note

If the attendant waits for the transfer destination phone to start ringing before completing the transfer this cancels the consult transfer and initiates a blind transfer to the destination.

Blind Transfer (Standard Functionality)

This scenario describes a call being answered and then blind transferred to a destination, without using the direct transfer feature. When the call is answered, it will appear to be from the Service Queue device.

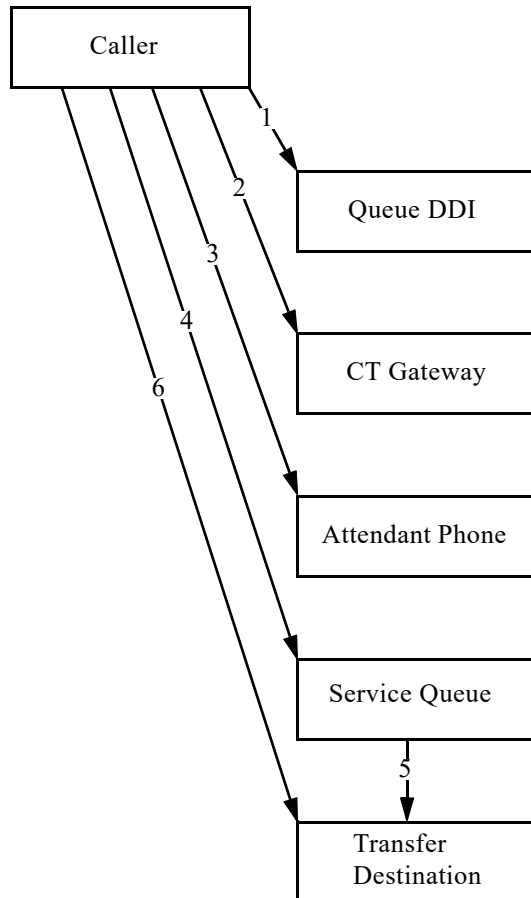

1. Call arrives at the Queue DDI device. This notifies Cisco Unified Attendant Console Advanced that the call has arrived for the specified queue, and allows for CLI filter checking. The CSS of the CTI Route Point (Queue DDI) is now being used.
2. Call is routed to the pool of CT Gateway devices, based on the Queue Device Group of the Pre CT Gateway. The call is now being made from the originating point to the CT Gateway. The CSS changes from that of the originating point to that of the CT Gateway port.
3. The attendant chooses to answer the call or the call is delivered by forced delivery. The call is routed from the CTI Port to the attendant's phone. They are now connected to the original caller. The call now takes the CSS of the attendant's line/phone.
4. The attendant dials the destination for the blind transfer, and the call is transferred to one of the pools of service queue devices, according to the Queue Device group it originally arrived at. The CSS changes from that of the attendant's line to that of the Service Queue port.
5. The Service Queue answers and puts the call on hold and then makes an enquiry call to the end destination.
6. When the call is answered by the destination the call is connected.

Blind Transfer (Direct Transfer)

This scenario describes a call being answered and then blind transferred to a destination, using the direct transfer feature of Arc. This labels the call as being from the original caller, rather than the Arc Service Queue device.

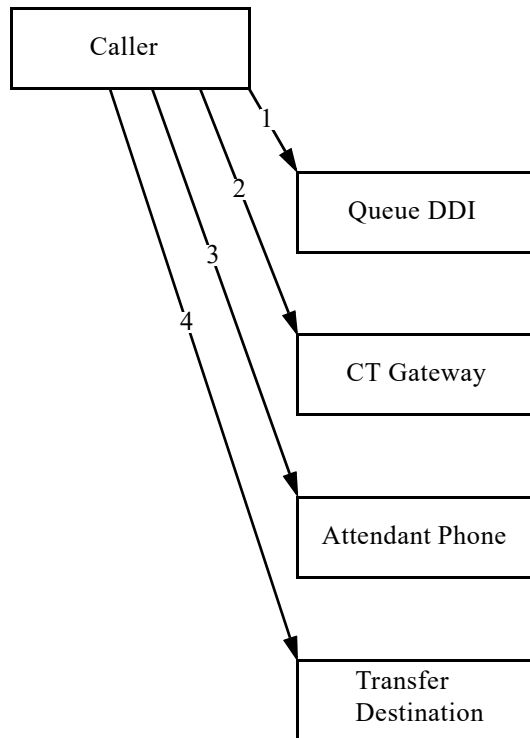

1. Call arrives at the Queue DDI device. This notifies Cisco Unified Attendant Console Advanced that the call has arrived for the specified queue, and allows for CLI filter checking. The CSS of the CTI Route Point (Queue DDI) is now being used.
2. Call is routed to the pool of CT Gateway devices, based on the Queue Device Group of the Pre CT Gateway. The call is now being made from the originating point to the CT Gateway. The CSS changes from that of the originating point to that of the CT Gateway port.
3. The attendant chooses to answer the call or the call is delivered by forced delivery. The call is routed from the CTI Port to the attendant's phone. They are now connected to the original caller. The call now takes the CSS of the attendant's line/phone.
4. The attendant dials the destination for the blind transfer, the call will be transferred from the attendant's extension to the transfer destination, using the attendant's line CSS.

Night Service/Overflows/Out of Service

This scenario describes calls that:

- End up at night service
- Overflow according to a condition
- Go to an out of service number and have a destination number that is a DN, rather than an internal queue.

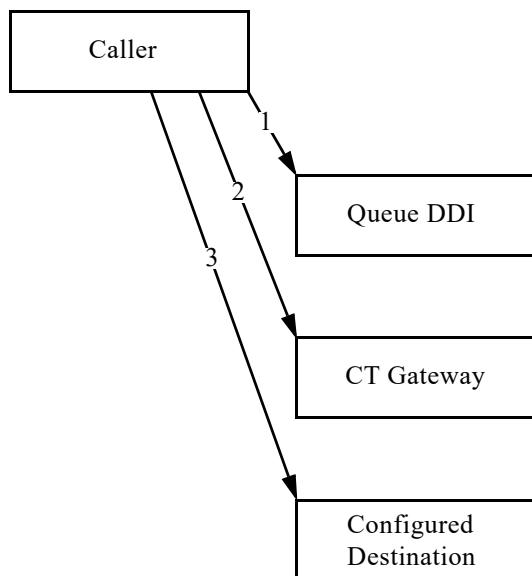

1. Call arrives at the Queue DDI device. This notifies Cisco Unified Attendant Console Advanced that the call has arrived for the specified queue, and allows for CLI filter checking. The CSS of the CTI Route Point (Queue DDI) is now being used.
2. Call is routed to the pool of CT Gateway devices, based on the Queue Device Group of the Pre-CT Gateway. The call is now being made from the originating point to the CT Gateway. The CSS changes from that of the originating point to that of the CT Gateway port.
3. Depending on how night service/overflow/out of service forwarding is configured, the call is forwarded to the destination DN.

Queue Overflow - Best Practice

While configuring any queue overflow to an alternate queue, it is important to avoid any call looping scenarios as they will result in unnecessary call handles and potentially call control errors. With this in mind, take the following use case and expand upon it to meet your individual queuing needs.

Two Queues

- Queue A
- Queue B

Requirement

While Queue A or B is offline, calls need to be routed to the adjacent Queue (that is, Queue A is offline, and any calls coming in to Queue A should be routed to Queue B).

Best Practice Solution

Create two additional Queues:

- Queue A
- *Queue B OFLOW*
- Queue B
- *Queue A OFLOW*

In the **Queue A - Queue Management** menu, specify **Queue Destination Type** and **No Operator Destination** as *Queue A OFLOW*.

In the **Queue B - Queue Management** menu, specify **Queue Destination Type** and **No Operator Destination** as *Queue B OFLOW*.

In the **Queue A OFLOW/Queue B OFLOW Queue Management** menus, refrain from configuring the overflows to route back to the original queues as this will result in the call looping behavior warned against. Instead, use a voicemail box, alternate queue, or alternate destination as a **Max Wait Time Overflow**, **Max Calls Overflow**, or **No Operator Overflow**.

After configuring your queue overflows appropriately, proceed with assigning your queues to respective operators:

- Operator A - Associate Queue A and Queue B OFLOW
 - Operator B - Associate Queue B and Queue A OFLOW
-

Outcome

While Operator A is not signed in to the console, all calls to Queue A will route to Operator B's Queue A OFLOW queue.

While Operator B is not signed in to the console, all calls to Queue B will route to Operator A's Queue B OFLOW queue..

Holding Calls

This scenario describes a call being answered, held, and then retrieved.

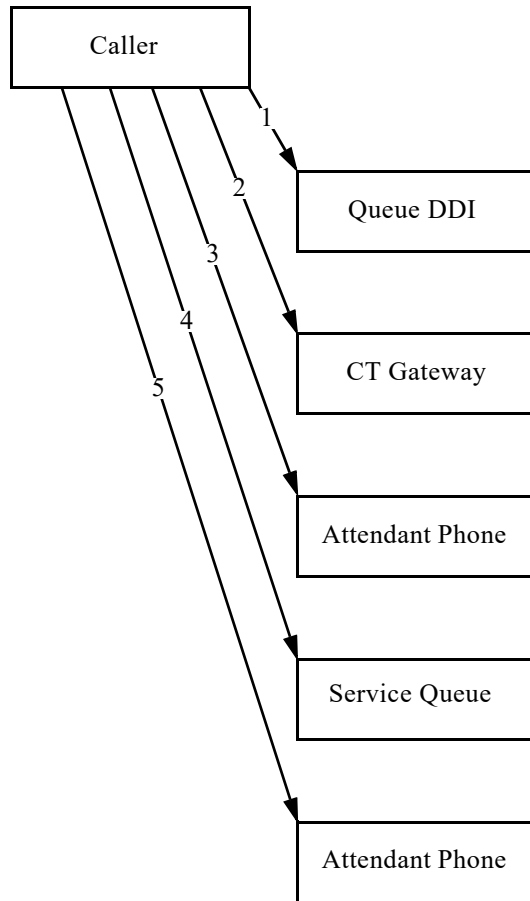

1. Call arrives at the Queue DDI device. This notifies Cisco Unified Attendant Console Advanced that the call has arrived for the specified queue, and allows for CLI filter checking. The CSS of the CTI Route Point (Queue DDI) is now being used.
2. Call is routed to the pool of CT Gateway devices, based on the Queue Device Group of the Pre CT Gateway. The call is now being made from the originating point to the CT Gateway. The CSS changes from that of the originating point to that of the CT Gateway port.
3. The attendant chooses to answer the call or the call is delivered by forced delivery. The call is routed from the CTI Port to the attendant's phone. They are now connected to the original caller. The call now takes the CSS of the attendant's line/phone.
4. The attendant places the call on hold, the call is routed to one of the service queue devices, according to the Queue Device group of the original queue though which the call entered. The call now has the CSS of the Service Queue port.
5. If the attendant retrieves the call, it is redirected back to their phone. The call then reverts back to the CSS of their line/phone.

Parking Calls

The scenario describes a call being parked and then picked up from the park location by the intended recipient.

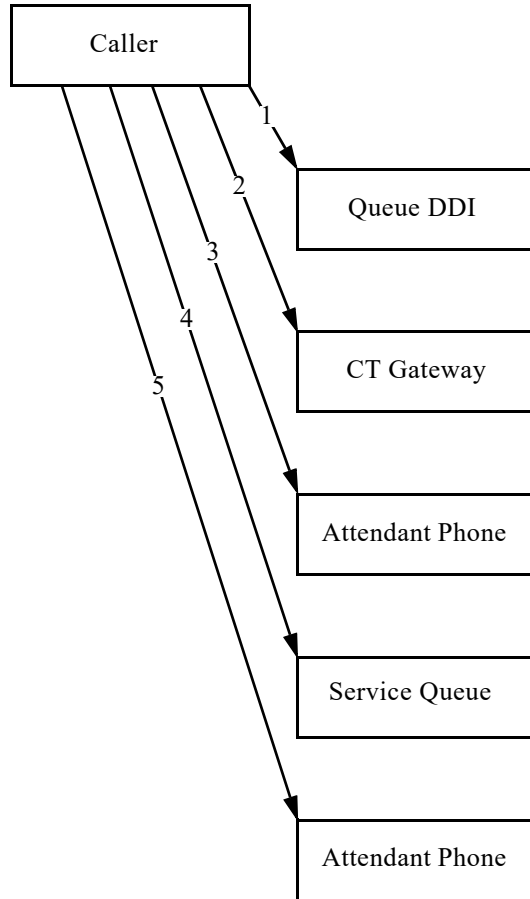

1. Call arrives at the Queue DDI device. This notifies Cisco Unified Attendant Console Advanced that the call has arrived for the specified queue, and allows for CLI filter checking. The CSS of the CTI Route Point (Queue DDI) is now being used.
2. Call is routed to the pool of CT Gateway devices, based on the Queue Device Group of the Pre CT Gateway. The call is now being made from the originating point to the CT Gateway. The CSS changes from that of the originating point to that of the CT Gateway port.
3. The attendant chooses to answer the call or the call is delivered by forced delivery. The call is routed from the CTI Port to the attendant's phone. They are now connected to the original caller. The call now takes the CSS of the attendant's line/phone.
4. The attendant parks the call for a user, the call is routed to one of the call park devices based on the original Queue Device group of the call. The call then takes the CSS of the CTI Port where it is parked.
5. An end user dials to the Call Park device. Their CSS must have access to the Call Park Devices. When that call is connected, it is connected with the call in the Call Park.



Note If the call is retrieved by the attendant, rather than getting picked up by the intended recipient, the call flow is as that of a held call.

Call Flow Example With Partition/CSS

This example explains how the theory above can be used:

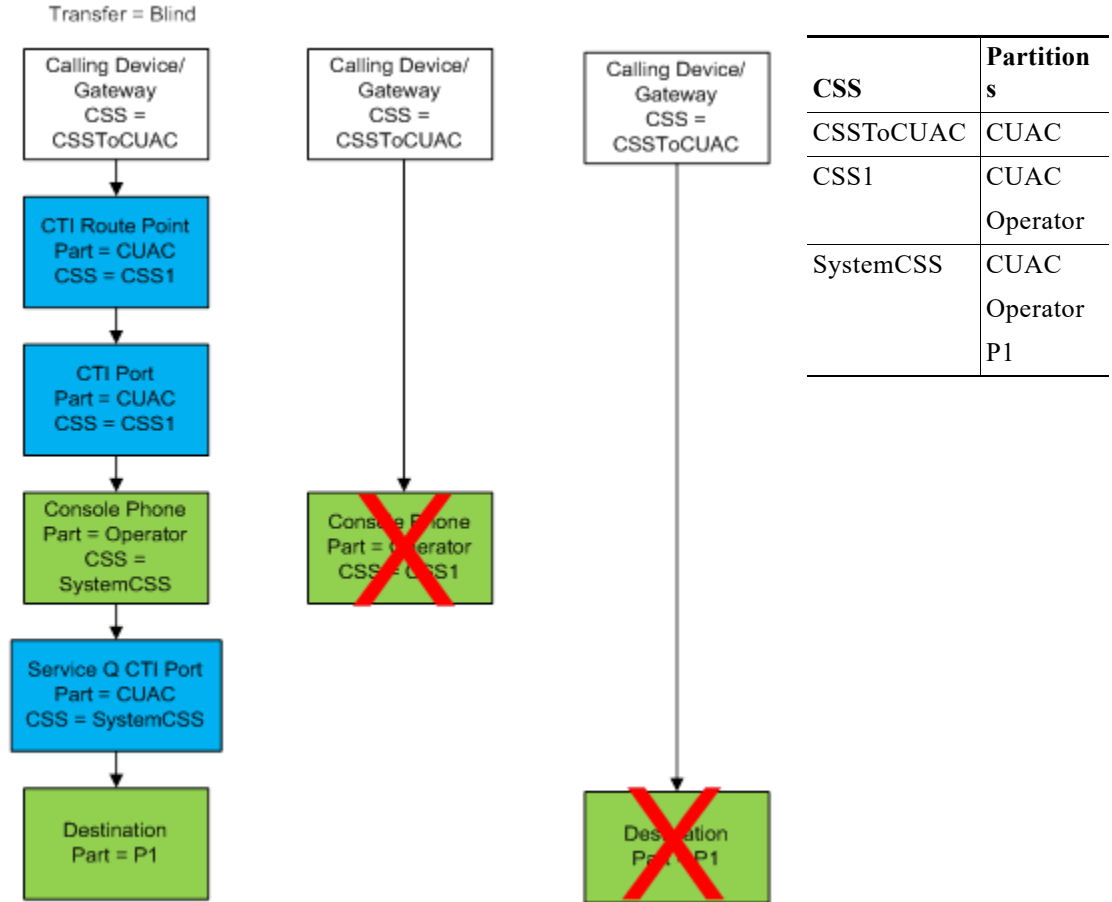

In this example a call is made into the system via a gateway. The Gateway's assigned CSS is CSSToCUAC, which contains just the CUAC partition. The devices in the blue boxes are the Cisco Unified Attendant Console Advanced System Devices, and are in the CUAC partition; so the call on the Gateway can dial any of those devices. However, the console phone is in a different partition, Operator, which is not in the CSS assigned to the Gateway; so a call cannot be routed from the Gateway directly to the attendant. Likewise, the final destination of the call is also in a partition, P1, that cannot be directly reached from the Gateway.

The following occurs:

1. The call is routed from the Gateway to the CTI Route Point (which uses the DDI to determine which queue the call will go into). The CTI Route Point changes the CSS to CSS1, which includes the CUAC partition and the Operator partition.
2. The call is routed to the Host PBX Gateway port (a CTI Port that queues calls), which has the same CSS as the CTI Route Point.
3. The call is routed to the attendant's handset in partition Operator, which is included in CSS1 and also the CSS SystemCSS.
4. Because the destination uses the P1 partition in the SystemCSS CSS, the call can be delivered to it as a blind transfer via a Service Queue CTI Port that also uses SystemCSS.

Configuring Controlled CTI Devices

To maintain the integrity and stability of Controlled CTI Devices, Cisco recommends that you assign them to a dedicated Device Pool. Register your Controlled CTI Devices on the least-used Cisco Unified Communications Managers within the cluster, and register your IP Phones to other Cisco Unified Communications Managers in the cluster.

Configuring CTI Manager and Cisco TSP

The CTI Manager service provides CTI information to the Cisco TSP Client, both of which run on the Cisco Unified Communications Manager server. In effect, the CTI Manager acts as a TAPI server and the Cisco TSP acts as the TAPI Client. CTI Manager is disabled by default, but you can enable it on a server-by-server basis.

The CTI Manager can view the CTI information for devices registered to any node on the Cisco Unified Communications Manager cluster.

When configuring the Cisco TSP on the Cisco Unified Attendant Console Advanced server, set the Primary and Backup CTI Manager to the IP Address of the Cisco Unified Communications Manager(s) for which they will handle communication. This will help balance the load across the cluster and provide stability for the Cisco Unified Attendant Console Advanced devices.

Cisco Unified Attendant Console Advanced supports Secure TSP instances. See the Cisco TAPI documentation for configuration instructions. Cisco Media Driver Configuration UDP Port Range should account for a minimum of 1000 Media Channels. By default, the Start Range is set to 50000 and End Range is set to 54000.



Note

Configure the CTI Manager using its IP address, not the DNS name of the server. This prevents TAPI connectivity from being reliant on any DNS servers within the network.

Supported Handsets

The following phone types are supported as attendant console handsets, or as End Points (display line state and can receive transferred calls).















Note











Note the following:

- Shared lines (multiple lines with the same number) are not supported for attendant console handsets.
- Third-party SIP phones cannot be supported as attendant console handsets or for line state.
- Cisco Unified Attendant Console Advanced does not support logging on any device that has a duplicate DN, or that uses Extension Mobility.
- When using a sign-in device like Cisco IP Phone or Jabber Softphone to execute call controls, consider the following:
 - To leverage all Cisco Unified Attendant Console Advanced call control features and build comprehensive reports, aside from answering and terminating calls, call controls (transfer, hold, park, conference and so on) must be executed within the console application.
 - Answering and terminating calls from the sign-in device or an equipped headset is supported. To avoid duplicate answer or terminate requests resulting in call control errors, execute the call control from either the console client application or the sign-in device.
 - Call controls initiated from within the console application must be completed within the console application. For example, if initiating a consult transfer from the console application, it must be completed using the console application. The same applies to using the sign-in device to execute call controls. For example, if initiating a consult transfer from the sign-in device, it must be completed using the sign-in device.











● = supported, ○ = unsupported.











Model	Image	Directory BLF Status		Console Login Device	
		SCCP	SIP	SCCP	SIP
3905		○	●	○	○
3911		○	●	○	○
3951		○	●	○	○
6901		●	●	○	○



6911		●	●	●	○
6921		●	●	●	○
6941		●	●	●	●
6945		●	●	●	○
6961		●	●	●	●
7811		○	●	○	●
7821		○	●	○	●
7841		○	●	○	●
7861		○	●	○	●

7905		●	●	●	●
7906		●	●	●	●
7910		●	○	○	○
7911		●	●	●	●
7912		●	●	●	○
7915		●	●	●	○
7916		●	●	●	○
7920		●	○	○	○
7921		●	○	○	○
7925		●	○	○	○
7925G		●	○	○	○

7925G-EX		<input checked="" type="checkbox"/>	<input type="checkbox"/>	<input type="checkbox"/>	<input type="checkbox"/>
7926		<input checked="" type="checkbox"/>	<input type="checkbox"/>	<input type="checkbox"/>	<input type="checkbox"/>
7931 ¹		<input checked="" type="checkbox"/>	<input checked="" type="checkbox"/>	<input checked="" type="checkbox"/> ²	<input checked="" type="checkbox"/> ²
7935		<input checked="" type="checkbox"/>	<input type="checkbox"/>	<input type="checkbox"/>	<input type="checkbox"/>
7936		<input checked="" type="checkbox"/>	<input type="checkbox"/>	<input type="checkbox"/>	<input type="checkbox"/>
7937		<input checked="" type="checkbox"/>	<input type="checkbox"/>	<input type="checkbox"/>	<input type="checkbox"/>
7937G		<input checked="" type="checkbox"/>	<input type="checkbox"/>	<input type="checkbox"/>	<input type="checkbox"/>
7940		<input checked="" type="checkbox"/>	<input checked="" type="checkbox"/>	<input checked="" type="checkbox"/>	<input type="checkbox"/>
7941		<input checked="" type="checkbox"/>	<input checked="" type="checkbox"/>	<input checked="" type="checkbox"/>	<input checked="" type="checkbox"/>
7941G-GE		<input checked="" type="checkbox"/>	<input checked="" type="checkbox"/>	<input checked="" type="checkbox"/>	<input checked="" type="checkbox"/>
7942		<input checked="" type="checkbox"/>	<input checked="" type="checkbox"/>	<input checked="" type="checkbox"/>	<input checked="" type="checkbox"/>

7942-G		●	●	●	●
7945		●	●	●	●
7945G		●	●	●	●
7960		●	●	●	○
7961		●	●	●	●
7961G-GE		●	●	●	●
7962		●	●	●	●
7965		●	●	●	●
7965G		●	●	●	●
7970		●	●	●	●
7971		●	●	●	●

7975		<input checked="" type="checkbox"/>	<input checked="" type="checkbox"/>	<input checked="" type="checkbox"/>	<input checked="" type="checkbox"/>
7985		<input checked="" type="checkbox"/>	<input type="checkbox"/>	<input checked="" type="checkbox"/>	<input type="checkbox"/>
8811		<input type="checkbox"/>	<input checked="" type="checkbox"/>	<input type="checkbox"/>	<input checked="" type="checkbox"/>
8841		<input type="checkbox"/>	<input checked="" type="checkbox"/>	<input type="checkbox"/>	<input checked="" type="checkbox"/>
8845		<input type="checkbox"/>	<input checked="" type="checkbox"/>	<input type="checkbox"/>	<input checked="" type="checkbox"/>
8851		<input type="checkbox"/>	<input checked="" type="checkbox"/>	<input type="checkbox"/>	<input checked="" type="checkbox"/>
8851NR		<input type="checkbox"/>	<input checked="" type="checkbox"/>	<input type="checkbox"/>	<input checked="" type="checkbox"/>
8861		<input type="checkbox"/>	<input checked="" type="checkbox"/>	<input type="checkbox"/>	<input checked="" type="checkbox"/>
8865		<input type="checkbox"/>	<input checked="" type="checkbox"/>	<input type="checkbox"/>	<input checked="" type="checkbox"/>
8865NR		<input type="checkbox"/>	<input checked="" type="checkbox"/>	<input type="checkbox"/>	<input checked="" type="checkbox"/>

8941		<input checked="" type="checkbox"/>	<input checked="" type="checkbox"/>	<input checked="" type="checkbox"/>	<input checked="" type="checkbox"/>
8945		<input checked="" type="checkbox"/>	<input checked="" type="checkbox"/>	<input checked="" type="checkbox"/>	<input checked="" type="checkbox"/>
8961		<input type="checkbox"/>	<input checked="" type="checkbox"/>	<input type="checkbox"/>	<input checked="" type="checkbox"/> ²
9951		<input type="checkbox"/>	<input checked="" type="checkbox"/>	<input type="checkbox"/>	<input checked="" type="checkbox"/> ²
9971		<input type="checkbox"/>	<input checked="" type="checkbox"/>	<input type="checkbox"/>	<input checked="" type="checkbox"/> ²
Calling for Webex Teams (Unified CM) ³		<input type="checkbox"/>	<input checked="" type="checkbox"/>	<input type="checkbox"/>	<input checked="" type="checkbox"/>
Cisco Jabber for Android		<input type="checkbox"/>	<input type="checkbox"/>	<input type="checkbox"/>	<input type="checkbox"/>
Cisco Jabber for iPad		<input type="checkbox"/>	<input type="checkbox"/>	<input type="checkbox"/>	<input type="checkbox"/>
Cisco Jabber for iPhone		<input type="checkbox"/>	<input type="checkbox"/>	<input type="checkbox"/>	<input type="checkbox"/>

Cisco Jabber for Mac		<input type="radio"/>	<input checked="" type="radio"/>	<input type="radio"/>	<input checked="" type="radio"/>
Cisco Jabber for Windows		<input type="radio"/>	<input checked="" type="radio"/>	<input type="radio"/>	<input checked="" type="radio"/>
Cius		<input type="radio"/>	<input checked="" type="radio"/>	<input type="radio"/>	<input type="radio"/>
DX650		<input type="radio"/>	<input checked="" type="radio"/>	<input type="radio"/>	<input checked="" type="radio"/>
DX70		<input type="radio"/>	<input checked="" type="radio"/>	<input type="radio"/>	<input checked="" type="radio"/>
DX80		<input type="radio"/>	<input checked="" type="radio"/>	<input type="radio"/>	<input checked="" type="radio"/>
IP Communicator		<input checked="" type="radio"/>	<input checked="" type="radio"/>	<input checked="" type="radio"/>	<input checked="" type="radio"/>

1. If the operator is using a Cisco 7931 IP phone, maximum calls on the Cisco Unified Communications Manager must be set to at least two.
2. Support with disable rollover.
3. When connected with Cisco Unified Communication Manager for CTI.

Jabber Support

Both standard installations (locally installed on the operator computer) and VXME installations (installed in a VXME environment) are supported as operator devices and end points.



Dial Plans

Cisco Unified Attendant Server applies the following dial plan processes to any overflow and outbound calls from console users:

- [Number Validation Process](#)
- [No Access Number or Country Code Configuration](#)
- [External Access Number](#)
- [External International Access Number](#)
- [Exclude Local Country Code](#)

For examples of dial plan processes, see [Sample Configurations](#).



Note

For more information about configuring Access Numbers, see the *Cisco Unified Attendant Console Advanced Administration and Installation Guide*.

Number Validation Process

Cisco Unified Attendant Console Advanced performs a validation process on all outbound calls, removing any character not present in the following table.

Valid Dial Characters	
+	*
#	0
1	2
3	4
5	6
7	8
9	

No Access Number or Country Code Configuration

In the absence of an External Access Number, External International Access Number and Exclude Local Country Code configuration, Cisco Unified Attendant Console Advanced processes internal and external calls identically, performing only the **Number Validation Process**.

Examples:

Original Number: +1 (234) 567-8910

Transformed Number: +12345678910

External Access Number

This is the number added to the start of a number to access an external line. Supported characters are 0-9 (digits zero to nine), * (star), # (hash), ((open bracket) and) (close bracket).

If configured, transformation result appears as: *<External Access Number><Number Validation Process Result>*

Examples:

Original Number: +1 (234) 567-8910

External Access Number: *1

Transformed Number: *1+12345678910

External International Access Number



Note

Successful application of the dial plan criteria **External International Access Number** and **Exclude Local Country Code** is contingent upon the provided number format.

The dial plan identifies an international number by searching for a country code which must be formatted as *<plus (+)><Valid Dial Character(s)><Invalid Dial Character (such as a space or bracket)>*

Examples:

- +44 123456: the identified country code is +44
- +44(123)456: the identified country code is +44
- 123+44 456: the identified country code is +44
- +44123456: the identified country code is +44123456

An **External International Access Number** is added to the start of a phone number to access an international line. The Outbound Number must contain a + (plus) to be processed as an international number. Supported characters are 0-9 (digits zero to nine), * (star), # (hash), ((open bracket) and) (close bracket).

If the phone number contains a + (plus) character, this classifies it as an international number and the following processing occurs in the order prescribed:

- a. The plus (+) and all numbers following it up to the first invalid dial character (characters not in [Table 4-1](#)) are classed as the country code and are temporarily removed.

Examples (country code is in bold):

1. 123+**456789** is transformed to 123

2. 123+45 6789 is transformed to 1236789
 3. +12 3456789 is transformed to 3456789
 4. +123456789 is transformed to <empty>
 5. 1+23-4-5(6)7(8)9 is transformed to 1-4-5(6)7(8)9
- b. The transformed number from a. removes any numbers within brackets and also the brackets themselves.
- For example, the transformed number from a.-5., 1-4-5(6)7(8)9, becomes 1-4-579.
- c. The **Number Validation Process** is executed.
- For example, the transformed number from b., 1-4-579, becomes 14579.
- d. The country code removed as part of a. is added to the front of transformed number from c.
- For example, the transformed number from c., 14579, becomes 2314579.
- e. Finally, the configured **External International Access Number** is added to the number from d.
- For example, if the External International Access Number is set to *111, then using the output from d., 2314579, it becomes *1112314579.

Exclude Local Country Code



Note

Successful application of the dial plan criteria **External International Access Number** and **Exclude Local Country Code** is contingent upon the provided number format.

The dial plan identifies an international number by searching for a country code which must be formatted as <plus (+)><Valid Dial Character(s)><Invalid Dial Character (such as a space or bracket)>

Examples:

- +44 123456: the identified country code is +44
- +44(123)456: the identified country code is +44
- 123+44 456: the identified country code is +44
- +44123456: the identified country code is +44123456

This is the country code of the CUCM where the calls are dialed out from. The purpose of this field is identify outbound calls to the local country by matching the provided country code to a transformed number. If a match is found, the call is processed as a local external call as opposed to an international external call.

For this to impact number transformation, the number must contain a (+) plus character. Valid characters are 0-9 (digits zero to nine).

The following processing occurs:

- a. The number is treated the same as in step a. where the country code is identified and removed.
- b. If the removed country code matches the specified **Exclude Local Country Code**, the transformed number from step a. is classed as a local number and handled by [No Access Number or Country Code Configuration](#) or [External Access Number](#).
- c. If the removed country code does not match the specified **Exclude Local Country Code**, the outbound call is processed as an [External International Access Number](#).

Sample Configurations

The following sample configurations illustrate the call processing options.

Internal\External Access Configuration		
External Access Number	<empty>	
External International Access Number	<empty>	
Exclude Local Country Code	<empty>	

Dial Plan Processing		
Original Number	Translated Number	Notes
020 8123 4567	02081234567	As no configuration has been specified, everything is treated as a local external number. Therefore, the only thing that happens is that invalid dial characters are removed. Invalid dial characters are any characters that don't appear in Table 4-1 .
020-8123-4567	02081234567	As above.
020.8123.4567	02081234567	As above.
+44(0)20#8123*45+67	+44020#8123*45+67	As above.
+44 (0)20 8123 4567	+4402081234567	As above.
+4402081234567	+4402081234567	As above.
+44 020 8123 4567	+4402081234567	As above.
+44-020-8123-4567	+4402081234567	As above.
+44.020.8123.4567	+4402081234567	As above.
1+23-4-5(6)7(8)9	1+23456789	As above.

Internal\External Access Configuration

External Access Number	9
External International Access Number	<empty>
Exclude Local Country Code	<empty>

Dial Plan Processing

Original Number	Translated Number	Notes
020 8123 4567	902081234567	Local external number. Remove invalid dial characters and add the External Access Number at the start of the translated number. Invalid dial characters are any characters that don't appear in Table 4-1 .
020-8123-4567	902081234567	As above.
020.8123.4567	902081234567	As above.
+44(0)20#8123*45+67	9+44020#8123*45+67	Because only the External Access Number is configured, this number is treated as a local external number, invalid dial characters are removed and the External Access Number is added at the start of the translated number.
+44 (0)20 8123 4567	9+4402081234567	As above.
+4402081234567	9+4402081234567	As above.
+44 020 8123 4567	9+4402081234567	As above.
+44-020-8123-4567	9+4402081234567	As above.
+44.020.8123.4567	9+4402081234567	As above.
1+23-4-5(6)7(8)9	91+23456789	As above.

Internal\External Access Configuration

External Access Number	9
External International Access Number	7
Exclude Local Country Code	<empty>

Dial Plan Processing

Original Number	Translated Number	Notes
020 8123 4567	902081234567	Local external number. Remove invalid dial characters and add the External Access Number , providing it has been configured, at the start of the translated number. Invalid dial characters are any characters that don't appear in Table 4-1 .
020-8123-4567	902081234567	As above.
020.8123.4567	902081234567	As above.
+44(0)20#8123*45+67	74420#8123*45+67	Because an External International Access Number has been specified and this number has a + (plus) character, this number is treated as an international number. The + (plus) is removed from the country code (+44) along with all the characters within the brackets and the brackets themselves. Invalid dial characters are also removed. Finally, the External International Access Number is added to the beginning of the number.
+44 (0)20 8123 4567	7442081234567	As above.
+4402081234567	74402081234567	As above, except that although this looks correct and the number is treated as an international number and hence the External International Access Number has been added to the beginning of the number, the processing thinks the country code is <i>+4402081234567</i> . This is because for the processing to identify a country code, the country code needs to be followed by an invalid dial character.
+44 020 8123 4567	74402081234567	Because an External International Access Number has been specified and this number has a + (plus) character, this number is treated as an international number. The + (plus) is removed from the country code (+44) and invalid dial characters are also removed. Finally, the External International Access Number is added to the beginning of the number.
+44-020-8123-4567	74402081234567	As above.

Internal\External Access Configuration		
+44.020.8123.4567	74402081234567	As above.
1+23-4-5(6)7(8)9	72314579	Because an External International Access Number has been specified and this number has a + (plus) character, this number is treated as an international number. The + (plus) is removed from the country code (+23) along with all the characters within the brackets and the brackets themselves. Invalid dial characters are also removed. Finally, the External International Access Number is added to the beginning of the number, followed by the removed country code (23).

Internal\External Access Configuration	
External Access Number	9
External International Access Number	7
Exclude Local Country Code	44

Dial Plan Processing		
Original Number	Translated Number	Notes
020 8123 4567	902081234567	Local external number. Remove invalid dial characters and add the External Access Number , providing it has been configured, at the start of the translated number. Invalid dial characters are any characters that don't appear in Table 4-1 .
020-8123-4567	902081234567	As above.
020.8123.4567	902081234567	As above.
+44(0)20#8123*45+67	9020#8123*45+67	Because the country code (44) for this number matches the Exclude Local Country Code , this number is treated as a local number. The + (plus) is removed along with the country code (44). Invalid dial characters are also removed. Finally, because this is a local number, the External Access Number , providing it has been configured, is added to the beginning of the number.
+44 (0)20 8123 4567	902081234567	As above.
+44 020 8123 4567	902081234567	Because the country code (44) for this number matches the Exclude Local Country Code , this number is treated as a local number. The + (plus) is removed along with the country code (44). Invalid dial characters are also removed. Finally, because this is a local number, the External Access Number , providing it has been configured, is added to the beginning of the number.
+44-020-8123-4567	902081234567	As above.
+44.020.8123.4567	902081234567	As above.

Internal\External Access Configuration

1+23-4-5(6)7(8)9	72314579	Because the country code for this number is identified as 23 which is different to the configured Exclude Local Country Code (44), this number is treated as an international number. The + (plus) is removed from the country code (+23) along with all the characters within the brackets and the brackets themselves. Invalid dial characters are also removed. Finally, the External International Access Number is added to the beginning of the number, followed by the removed country code (23).
+4402081234567	74402081234567	Although the original number looks correctly formatted, it is not treated correctly as it is unable to identify 44 as the country code so it treats it as an international number. Hence, the + (plus) is removed and the External International Access Number is added to the beginning of the string.



Cisco Unified Attendant Console Advanced Resilience

Like all software, Cisco Unified Attendant Console Advanced may occasionally fail. This chapter describes the following:

- [Full Resilience](#)
- [Providing Additional Resilience](#)

Full Resilience

Cisco Unified Attendant Console Advanced can be installed in a resilient configuration with two Cisco Unified Attendant Console Advanced servers:

- **Publisher** — the primary server used by the Clients. If this fails all Attendant Operators are switched to the Subscriber server. Once the Publisher is running again, the operators are prompted to reconnect to the Publisher.
- **Subscriber** — used when the Publisher stops.

Each server requires a separate Application User profile to be configured on the Cisco Unified Communications Manager. If possible, each server should be connected to a different CTI Manager, otherwise both will be lost if that Cisco Unified Communications Manager node fails or is taken off-line.

On both servers ensure that the machine date, time and time zone are correct, and that they match those on the other machine. Both servers must be in the same time zone to ensure that any daylight-saving time changes occur simultaneously. If the servers do not match, the operator console will be unable to automatically reconnect to the Publisher when it recovers from failure.

If you have a firewall on either server, you must configure firewall exceptions (using **Control Panel > Windows Firewall > Allow a program or feature through Windows Firewall**) for the following:

- Windows Management Instrumentation (WMI)
- Port 135 (TCP) used by WMI



Note

WMI calls use port 135 before choosing a random port. During the Resilience installation, the CUAC process uses WMI to connect to an alternate server. This port is only required during the installation/uninstallation and replication configuration.

- Distributed Transaction Coordinator (MSDTC)

- Port 1433 (used by the SQL server)
- Ports 61616 and 61618, to enable messages to pass between the servers.

This section describes the following:

- [Database Replication, page 5-2](#)
- [Failover Scenarios, page 5-5](#)

Figure 5-1 on page 5-2 summarizes server resilience.

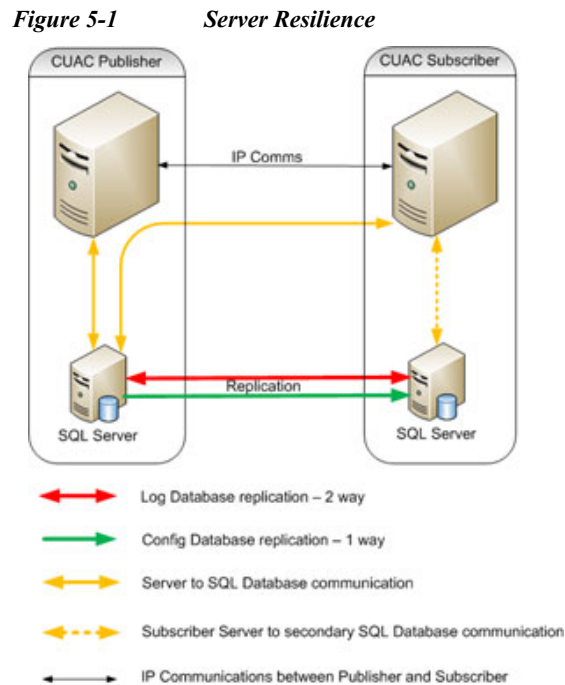

Database Replication

The Cisco Unified Attendant Console Advanced server contains two SQL databases:

- Logging database, contains a copy of the configuration and also holds all call transaction records for queues and operators.
- Configuration database, responsible for all user configurations. For more information, see [System Configuration, page 5-5](#).

SQL replication ensures that the databases in both servers are kept up to date and synchronized.

When running a resilience configuration the Publisher must use SQL 2008, 2012, 2014, 2016, 2017, 2019 (all Standard or Enterprise). The Subscriber can use SQL 2008, 2012, 2014, 2016 or 2019 Express, but because of its limitations you should use SQL Standard or Enterprise if you have more than ten operators. SQL Express only supports 4GB of data; so neither Publisher nor Subscriber database will grow larger than that, and when that limit is reached no new data will be written.

The configuration database is synchronized between the two servers using SQL replication (see below), and Push is used to replicate the data from Publisher to the Subscriber. The log databases are synchronized using Microsoft DTC to ensure that a full set of call transaction data is kept on both servers, thereby enabling you to run call reports from either.

SQL server replication involves:

- Snapshot replication
- Transactional replication

Snapshot replication makes an exact copy (snapshot) of the Publisher and distributes it to the Subscriber. It does not monitor for updates to the data. Snapshot replication is used to provide the initial data set for transactional replication; and it can also be used to completely refresh the data on the subscriber. After the initial snapshot, the Subscriber is kept up to date with the Publisher using transactional replication. Subsequent data transactions (INSERTed, UPDATED, and DELETED data) in the Publisher are captured by the transaction log and then stored in the distribution database, which acts as a data queue. The changes are then propagated and applied to the Subscriber in the order in which they occurred.

SQL server replication uses standalone programs called agents to track changes and distribute data between databases. The agents are:

- SQL server Agent-executes scheduled administrative tasks or jobs consisting of one or more jobsteps. Job information is stored in the SQL server. The other agents run as directed by this agent and it is required for the Publisher and Subscriber to be able to talk to each other.
- Distributor Agent-moves the snapshot and transactions from Publisher to Subscriber.
- Q Reader-a SQL server agent that handles the data queues.
- Snapshot Agent-prepares snapshot files containing schema and data of published tables and database objects, stores the files in the snapshot folder, and records synchronization jobs in the distribution database.
- Log Agent-monitors the transaction log of each database configured for transactional replication, and copies the transactions marked for replication from the transaction log into the distribution database.

Figure 5-2 illustrates the transactional replication used for the logging database.

Figure 5-2 *Logging Database Transactional Replication*

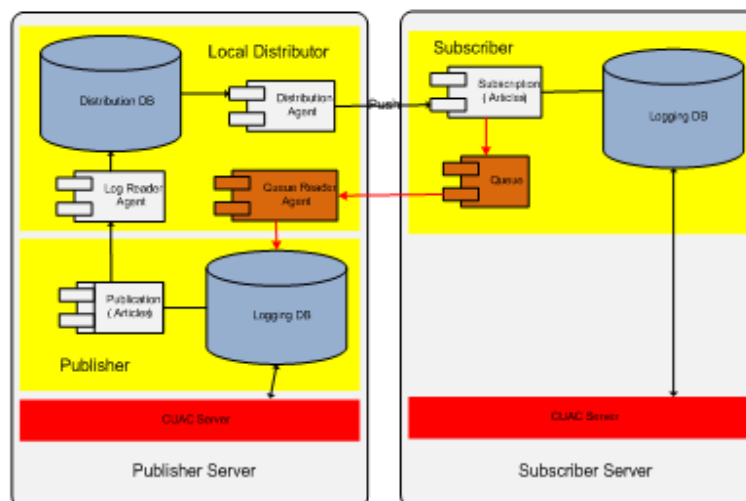
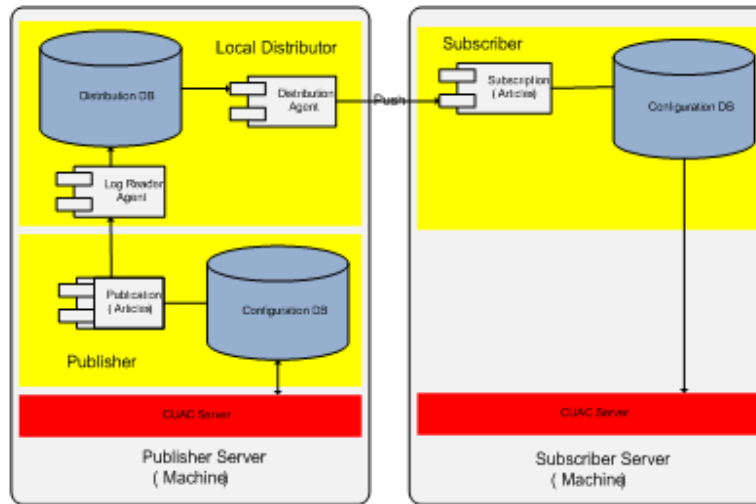

Figure 5-3 on page 5-4 illustrates the transactional replication used for configuration database.

Figure 5-3 Configuration Database Transactional Replication



The Publisher and Subscriber servers are linked using Apache Active MQ, an open-source message broker. When the system is updated with the user configuration on the Publisher, all the changes are sent to the Subscriber in real-time.



Note

If the inter-server communication link is down, all online updates will fail.

To check the status of the inter-server communication link:

1. Log in to Cisco Unified Attendant Console Advanced Web Admin and choose **Engineering > Service Management**.
2. View the activity and status of the Cisco Unified Attendant Server.

If the Inter Server Communication Status is **Suspended**, the ActiveMQ service may not be running.

To check and restart the ActiveMQ service:

1. In Control Panel, click **Accessories** and then click **Services**.
2. If the Status of the ActiveMQ service is blank (meaning that it is stopped), select the service and click **Start**.
3. Use Cisco Unified Attendant Console Advanced Web Admin to confirm that the Inter Server Communication Status is **Normal**.

Apache Active MQ is also used for real-time synchronization of operator and queue availability. It also enables the Publisher and Subscriber to detect whether the other has failed.

Cisco Unified Attendant Console Advanced can also be installed as a standalone, with no resilience. When installed in this mode, SQL Express Edition is automatically installed on the server, if no SQL server is detected. To convert a standalone installation to a resilient installation, you must first upgrade SQL Express to either SQL Standard or Enterprise.

For a resilient installation the Publisher server must be installed first, followed by the Subscriber server (the Subscriber installation communicates with the Publisher during its installation). Once installed a Publisher or Subscriber server cannot be converted into the other type. The Publisher requires at least

SQL server Standard to be installed, while the Subscriber can use SQL Express, although there are limitations on its use within the system, SQL Express will be installed automatically on a standalone installation if no existing SQL instances are detected on the server.

Both servers maintain a link to the Publisher SQL server. There is also a connection from the Subscriber to its local SQL server, which becomes a full connection if communication with the Publisher is lost.

System Configuration

The Cisco Unified Attendant Console Advanced configuration is mirrored on the two servers. However, each server has its own set of Controlled CTI devices. When you configure the Queue DDI DN on the Publisher the system sets *Forward on CTI Failure* and *Forward Unregistered Internal* to point to the Queue DDI of the mirrored queue on the Subscriber. These are used if the Publisher and its Queue DDI go out of service.

A Web Administration service running on both servers enables administrators to configure the system. However, most system configuration—including configuring the Controlled CTI Devices of both servers—can only be done when connected to the Publisher. You can view the configuration when connected to the Subscriber, as well as monitor replication and run reports, but the only things you can change are the Arrival Mode for each queue and the logging levels.

Failover Scenarios

Cisco Unified Attendant Console Advanced can experience the following types of failover scenario:

- Full failover
- Partial failover
- Full CTI failover

Full Failover

Full failovers result from the Publisher shutting down. For example:

- The CTI Manager fails or loses connection
- The server machine crashes
- The Cisco Unified Attendant Console Advanced server service is stopped manually

In these situations the server stops and the operators are logged out and prompted to connect to the Subscriber. Initially, incoming calls are routed to the Publisher Queue DDI, but then the Cisco Unified Communications Manager uses Call Forward to route them to the Subscriber Queue DDI. The calls then enter the Subscriber CT Gateway and are routed to an operator logged in to the Subscriber. Any calls that—at the time of the failure—were queuing or held on the Service Queue or Park device, are cut off. Calls that were connected to an operator remain connected.

Partial Failover

Partial failovers occur when all Queue DDI devices go out of service, but the other system devices remain active. This causes the calls to be routed to the Subscriber via the Call Forward, but the operators remain logged in to the Publisher. This results in calls ringing but with no operators able to see or answer them.

Full CTI Failover

Full CTI failover occurs when both the Publisher and Subscriber servers fail at the same time. You can try to prevent this happening by using different CTI Managers as primaries for each server. To mitigate the effects of a full CTI failover you can also set a destination against each queue. This will set *Forward on CTI Failure* and *Forward Unregistered Internal* destinations on the Queue DDI on Cisco Unified Communications Manager. Calls initially route to the Publisher Queue DDI, then forward to the Subscriber Queue DDI, and finally forward to the destination set against that.

Providing Additional Resilience

If the Cisco Unified Attendant Console Advanced server fails, all CTI devices go out of service and any calls ringing into or connected on any of those devices become disconnected.

Any new calls arriving at the system hear the unavailable tone. To ensure that new calls can be answered, access the Cisco Unified Communications Manager and set *Call Forward No Answer* or *Forward Unregistered Internal* on the CTI Route Points used for the Queue DDI numbers. These can be routed to any destination, including a hunt group or VM box. You can also use different destinations for different queues.

For further details, see the following:

- [CTI Manager Service Failure, page 5-6](#)
- [Cisco Unified Communications Manager Failure, page 5-7](#)
- [Client Handset Resets, page 5-7](#)

CTI Manager Service Failure

When a primary CTI Manager fails, the Cisco TSP sends the Cisco Unified Attendant Console Advanced server a message advising that the phone is suspended, followed by a *Line out of service* message for every phone and line device opened by the application. This results in the Controlled CTI devices and monitored phones being seen as *Out of Service*, and the Cisco Unified Attendant Console Advanced server shutting down within about 30 seconds. The Cisco TSP then tries to connect to the configured backup CTI Manager. When a connection to a backup CTI Manager is established and the device or line is successfully re-opened, the Cisco TSP sends a PHONESTATE_RESUME or LINEDEVSTATE_INSERTSERVICE message to the Cisco Unified Attendant Console Advanced server. At this point, the server is trying to restart itself. Once the CTI Manager is connected, the server resumes processing calls. If the Cisco TSP cannot open the device or line for a CTI Port or Route Point, it closes the device or line by sending the appropriate PHONE_CLOSE or LINE_CLOSE message to the Cisco Unified Attendant Console Advanced server.

After the Cisco TSP has connected to the backup CTI Manager, it will not reconnect to the primary CTI Manager until the connection is lost between the Cisco TSP and the backup CTI Manager, or the Cisco Unified Attendant Console Advanced server is restarted.

Once the Cisco Unified Attendant Console Advanced server stops, the operator Clients are logged out, TSP resilience is set up, and calls start being handled by the Backup CTI Manager. The server reconnects to the Backup CTI Manager and the Clients must log in again to take the calls. Ensure that the CTI Manager used by the Subscriber is on a different node to the Publisher. If both servers use the same CTI Manager they will fail simultaneously, and you will lose many more calls than otherwise.

Cisco Unified Communications Manager Failure

If the Cisco Unified Communications Manager node in a cluster on which the Cisco Unified Attendant Console Advanced Controlled CTI Devices are registered fails, the CTI Manager recovers the affected CTI Ports and Route Points by re-opening these devices on another Cisco Unified Communications Manager node. When the Cisco TSP detects the failure it sends a PHONE_STATE (PHONESTATE_SUSPEND) message to the Cisco Unified Attendant Console Advanced server. During the failure, the CTI Devices controlled by the Cisco Unified Attendant Console Advanced server will be *out of service* and unavailable. Calls cannot enter the Cisco Unified Attendant Console Advanced system during the failure. If the CTI Manager is also on the failed Cisco Unified Communications Manager node, the Cisco TSP on the Cisco Unified Attendant Console Advanced server switches to the backup CTI Manager.

When the CTI Port/Route Point is successfully re-opened on another Cisco Unified Communications Manager, the Cisco TSP sends a phone PHONE_STATE (PHONESTATE_RESUME) message to the server. If no Cisco Unified Communications Manager is available, the CTI Manager waits until one comes back in service and tries again to open the device. The lines on the affected device go out-of-service and in-service in accordance with the events sent by the Cisco TSP to the Cisco Unified Attendant Console Advanced server. If the device or lines cannot be opened, even when all the Cisco Unified Communications Manager nodes come back into service, the devices or lines are closed and Cisco TSP sends a PHONE_CLOSE or LINE_CLOSE message to Cisco Unified Attendant Console Advanced server.

The Cisco Unified Attendant Console Advanced server repeatedly stops and attempt to restart itself until the CTI functionality has returned. This process forces the CTI devices back into service. However, the Client applications lose their connections to the server as soon as it stops itself. Once the server is back on-line, the Client applications can reconnect to it and log in.

When a failed Cisco Unified Communications Manager node comes back in service, the CTI Manager re-opens the affected CTI Ports or Route Points to their original Cisco Unified Communications Manager. This re-opening takes place only when calls are no longer being processed and are inactive on the affected device. Consequently, the re-opening may not be made for a long time for Route Points, which can handle many simultaneous calls.

Client Handset Resets

If your Cisco handset reboots, the Client displays the message *Your phone has gone out of service. You will not be able to make or receive calls at this time.* On the Operator Console, the phone icon at the bottom of the window bears a red cross to indicate that the handset is out of service. The message continues to be displayed by the Client until the handset has re-registered and is ready for use. When this happens, the icon in the Operator Console reverts to its original appearance.



Directory Contacts, Devices and Line Status

This chapter covers the following topics:

- [Populating the Directory](#)
- [Caller ID and Contact Matching](#)
- [Monitor Change Notifications](#)
- [Shared Line Support](#)

Cisco Unified Attendant Console Advanced contacts can be imported directly from the following sources:

- Microsoft Active Directory
- Active Directory Lightweight Directory Service (AD LDS)
- Cisco Unified Communications Manager
- iPlanet Netscape Directory
- Bulk import/update via CSV
- Console users can manually add contacts via the console client

Populating the Directory

You can populate the Cisco Unified Attendant Console Advanced contact directory from Cisco Unified Communications Manager directory by importing user accounts using LDAP synchronization. The following information is imported:

- User ID
- Last Name
- Middle Name
- First Name
- Telephone Number from User Profile (the main number for the contact). This supplies the DN. If this is blank the contact is not imported.
- Mail ID
- Department

Change notification is not supported on Cisco Unified Communications Manager; so the whole data set is synchronized to the Cisco Unified Attendant Console Advanced server. You can synchronize the data as frequently as once per hour, but this is really only suitable for very small installations. With the larger installations you should only synchronize the data once a day, preferably outside of business hours.

Searching the Directory

The contact directory is used by operators when answering and transferring calls, and is a critical part of the system. To enable rapid database searching, the following fields are indexed so that they can be used as the configurable search fields in the Cisco Unified Attendant Console Advanced Client:

- Extension Number
- Department
- First Name
- Last Name
- Job Title
- Location
- User Field 1

Assigning Device Names to DNs (Cisco Unified Communications Manager)

The imported Device Name (strictly-speaking, the Resource Identifier or RID) is normally the MAC address. DNs are assigned Device Names in the following way:

1. The contact is imported from Cisco Unified Communications Manager.
2. The DN is assigned from the Telephone Number field.
3. A new look-up is performed using AXL, based on the DN and the partition configured using the Directory synchronization web page.
4. All DNs matching the assigned DN are imported.
5. Devices are named in the following way:
 - The top-ranked match has its Device Name inserted into the Cisco Unified Attendant Console Advanced directory, unless an Extension Mobility (EM) profile is in the list, when the Device Name is left blank.
 - Contacts with the same DN are assigned the same Device Name. If shared lines must use different Device Names you can change this manually in the Cisco Unified Attendant Console Advanced Client (Contact Details [F12]). For more information, see [Shared Line Support, page 6-10](#).

Assigning Device Names to DNs (External Sources)

To assign Device Names to DNs when using external directory sources:

1. Map the fields to be imported using Cisco Unified Attendant Console Advanced Web Admin. The telephone number is mandatory. First Name, Last Name and Company are recommended.
2. Import the data using an LDAP synchronization. None of the records are yet resolved against Cisco Unified Communications Manager.

3. When an operator searches for DN for the first time, the BLF plug-in resolves the device on the Cisco Unified Communications Manager.

The DN must be an exact match with the number as presented in the Cisco Unified Communications Manager to allow accurate line state information. In other words, if the number is on E164 in Active Directory, it must be stored in the Cisco Unified Communications Manager in the same format.

Caller ID and Contact Matching

When populating call tags, Cisco Unified Attendant Console Advanced performs a series of background activities on the calling/called party number to present an identifying name within the respective call tag. Cisco Unified Attendant Console Advanced used to perform a process known as **Contact Matching** where it matched the number with the local directory. Since version 14.0, additional functionality has been added to ensure console client users are presented with all available information about their calls. The application now performs the traditional Contact Matching activities and, in absence of a local directory match, it presents the Caller ID as presented in the Cisco Unified Communications Manager TSP feed wherein the name presented in the console client call tag matches the name presented on the login device.

Scenarios which trigger Caller ID and Contact Matching in Call Tags

- Inbound calls (via console queues and login extension)
- Outbound calls (via console client and login extension)
- Diverted calls (via console queues and login extension)

Caller ID and Contact Matching Prioritization

In scenarios where name data is available across one or more sources, the selection process uses the following priority listed from highest to lowest:

- Contact Matching - Cisco Unified Attendant Console Advanced - Full Directory
- Contact Matching - Cisco Unified Attendant Console Advanced - Shared Personal Directory Groups
- Contact Matching - Cisco Unified Attendant Console Advanced - Private Personal Directory Groups
- Caller ID - Cisco Unified Communications Manager PBX - Name pulled from API Property: DeviceDisplayName
- No Match - results in the name 'Unknown Caller' being attributed in the call tag

Multiple Contact Matches within a Single Contact Matching Source

Unfortunate scenarios where multiple matches exist within any one of the Cisco Unified Attendant Console Advanced Contact Matching sources result in the selection of a single contact match to present in the Call Tag. Priority is given to the lowest alphanumeric-ordered system-generated *Contact_Unique_Ref* associated with each contact residing in the directory source.

There is no means of modifying the selection criteria within the application outside of deleting and repopulating contacts in the order in which they should be populated for contact matches, or modifying the telephone number to result in a unique match.

To obtain a list of all matches within the Cisco Unified Attendant Console Advanced Contact Matching source, a solution administrator requires local access to the Cisco Unified Attendant Console SQL Server.

1. Launch and log in to **SQL Server Management Studio**.
2. Expand **Server name > Databases > ATTCFG > Tables**.
3. Right-click *dbo.Contact_Summary_Details*.
4. Click **Select Top 1000 Rows**.
5. In the query window, add a new row after the last one, reading as follows:

Where <Extension, Business_1, Business_2, Home, or Mobile depending on the match being referenced> = 'number'.

For example, if you're looking for all matches against extension 1014, the new line would read as:
Where Extension = '1014'.

6. Add an additional new row with the following text: **Order by Contact_Unique_Ref**.
7. Click **Execute**.

Contacts with a **Source_Unique_Ref** value belong to a directory sync source; therefore, any modifications must be made at the directory source level. Contacts with no **Source_Unique_Ref** were created manually or imported via CSV file; therefore, they can be updated either on the console client or in WebAdministration as required.

Cisco Unified Communications Manager PBX - Caller ID

Caller ID as presented in the Cisco Unified Communications Manager is most often populated via:

- Cisco Unified CM Administration > Device > Phone/CTI Route Point > Line > Alerting Name
- Cisco Unified CM Administration > Device > Phone/CTI Route Point > Line > Display (Caller ID)
- Cisco Unified CM Administration > Call Routing > Directory Number > Alerting Name

For more information, see the Cisco Unified Communications Manager product literature.

Cisco Unified Attendant Console Advanced pulls the Console Call Tag Name from the CTI field **PlatformDisplayName**.

Monitor Change Notifications

Monitor Change Notifications is a feature introduced to enhance the directory integration with Microsoft Active Directory and Active Directory Lightweight Directory Services. When enabled, new, modified, and deleted directory contacts are immediately reflected in the Cisco Unified Attendant Console Advanced directory.



Note

Microsoft advises against using LDAP_SCOPE_SUBTREE when monitoring change notifications. Due to inconsistencies in the delivery of updates (new, edits, deletion) and performance implications, issues tied to the specification of LDAP_SCOPE_SUBTREE will be unsupported.

BLF Plug-in

Cisco Unified Attendant Console Advanced uses the BLF plug-in to enable you to view device and line state information on any device in the directory. The BLF plug-in monitors devices only when they are required. Using the BLF plug-in requires the *Standard CTI Allow Control of All Devices* role to be associated with the TSP User.

As console attendants search for contacts, the devices in the F3 Directory windows are opened and their device/line status monitored. Once a device is open, its state information remains available to the attendant without the BLF plug-in having to open it again.

The BLF plug-in holds the monitored devices in a cache, with a limit of 2000 simultaneous devices. Consequently, devices are monitored continuously only on small Cisco Unified Attendant Console Advanced systems.

Attendants communicate directly with the BLF plug-in to determine the line state. The following contact information is sent to the plug-in:

- DN
- Device Name (if available)
- Partition details

If a device with matching attributes is already in the cache, its state is immediately returned. If a matching device is not in the cache, the plug-in must open and monitor the device to determine its state.

Figure 6-1 BLF Plug-in Architecture

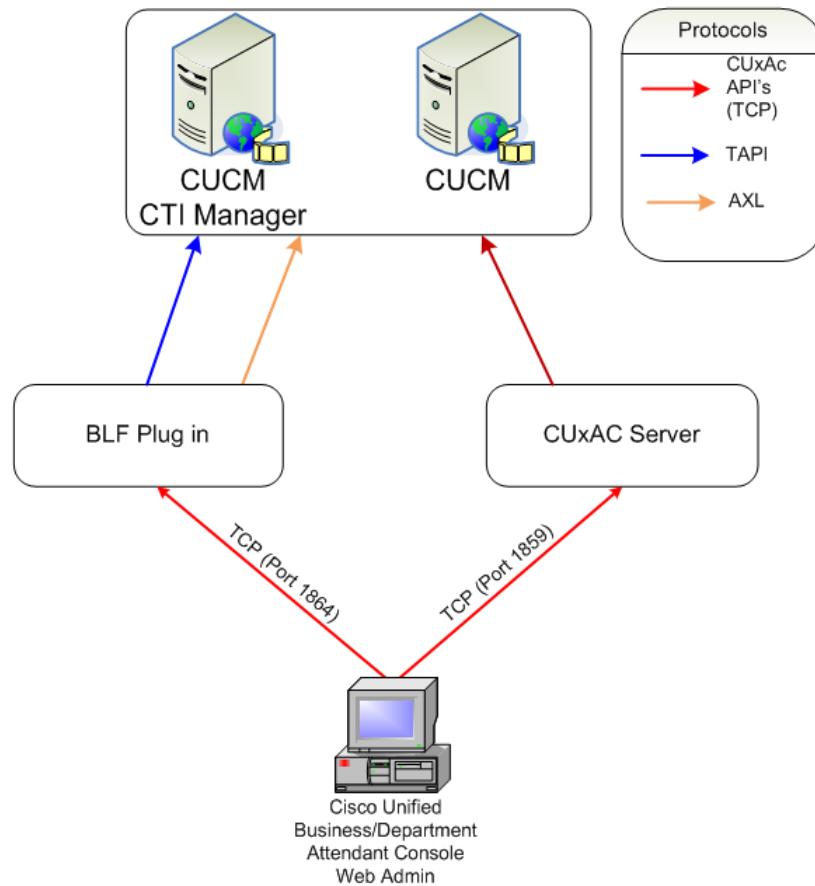
**Note**

Device/line state information is not available across multiple clusters.

If a contact has no Device Name or the *Limit BLF to device name* option is not set in that contact's details, the BLF plug-in must determine which device to monitor. It does this in the following way:

1. It sends an AXL request that includes the DN and Partition Identifier to the Cisco Unified Communications Manager.
2. All instances of that DN are returned to the BLF plug-in, along with the following additional information, which is used to rank the devices:
 - MAC address
 - Device name
 - Partition
 - Line index
 - Device profile
 - Extension Mobility count.
3. The BLF plug-in requests the state of the top ranked device.

If a device is replaced with one having the same DN, the Device Name of the new device does not get updated during synchronization. Instead, you must manually amend the Device Name, as described below.

When you have amended the Device Name you must then restart the BLF plug-in.

Amending Device Names

To amend a Device Name do the following:

-
- Step 1** Run Cisco Unified Attendant Console Advanced and log in.
- Step 2** In the F3 Directory window select the contact.
- Step 3** Press F12 to display the **Contact Details** dialog box.
- Step 4** In the **Contact Details** dialog box, select **Contact Numbers**.
- Step 5** Edit the **Device Name** as required.
- Step 6** Click **OK**.
- Step 7** Restart the BLF plug-in using either:
- Cisco Unified Attendant Console Advanced Web Admin*
- Run Cisco Unified Attendant Console Advanced Web Admin and log in.
 - Choose **Engineering > Service Management**.
 - For **Cisco Unified Attendant BLF Plug-in**, clicking the red **Stop** button
 - Restart the plug-in by clicking the green button.
- OR
- Control Panel*
- Log in to the Cisco Unified Attendant Console Advanced server
 - In Control Panels, select **Administration Tools > Services**
 - Right-click the BLF plug-in and select **Restart**.
-

Device Selection

The Cisco Unified Attendant Console Advanced system uses the BLF Plug-in to monitor all devices.

The attendant requests data for a device from the BLF Plug-in and displays the busy lamp status that is returned:

- The attendant sends the following information to the CTI server:
 - DN
 - Device Name (if the option is set to use this)
 - Partition
 - Resource Identifier (RID) - This is the MAC address populated in the Contact Directory if this is set to be used.

2. The BLF server sends the following information to the Cisco Unified Communications Manager via AXL:
 - DN
 - Partition
 - Resource Identifier
3. The Cisco Unified Communications Manager returns all instances of devices matching the criteria it receives.
4. The BLF server then resolves (filters and sorts) the list of device instances, leaving it with a single device for which it requests the line state.

When resolving device numbers, the BLF Plug-in gives priority to those using Extension Mobility (EM), if they are logged in to a phone at the time. EM is supported in the directory but is not supported for any System Devices, such as CTI Ports and Route Points, nor for the devices used by attendants.

1. All matching DNs are sorted by EM Count, which ensures that all Extension Mobility profiles are prioritized. If any returned devices have an EM count, the other instances are deleted from data.
2. Existing lines are sorted by Line Index. A primary line has a Line Index of 0, a secondary line has an Index of 1, and so on. The line with the lowest index is selected.
3. If multiple instances remain, they are sorted by Device Description.
4. If there are still multiple matches, they are parsed by Device name: a unique alphanumeric sort of the MAC addresses of the devices.
5. The device at the top of the list is used and its Resource Identifier returned to the attendant. This device will also be queried by the CTI server via the TAPI TSP to ascertain its Device state and the states of its individual lines.

The following examples show the results that would be generated from various device line configurations.

Example 1

DN	MAC	Line Index	Partition	EM Count	Device Name	Profile Type	Device Profile
1000	SEP222222222222	0			Martin Primary	Static device	0
1000	EM_222222222222	1	PartB	279a22ab-9cb2-42c9-be81-3f26376060cc	Martin Secondary EM	EM Profile	
1000	EM_111111111111	0			Martin Primary EM	EM Profile	1
1000	SEP333333333333	1	PartA		Martin Secondary	Static Device	0
1000	SEP111111111111	1			Martin Softphone	Softphone	1

Depending on the information provided and the configuration settings, the expected resolution results are:

DN	Partition	Resource Identifier
1000		EM_222222222222
1000	PartA	SEP333333333333
1000	PartB	EM_222222222222

Example 2

DN	MAC	Line Index	Partition
1000	PHONEMAC_A	2	
1000	PHONEMAC_B	1	
1000	PHONEMAC_C	1	PARTITION_X
1000	PHONEMAC_D	2	PARTITION_Y

1. Resolve => (DN:1000, Partition: <empty>)
Result: [PHONEMAC_B]
2. Resolve => (DN:1000, Partition: PARTITION_X)
Result: [PHONEMAC_C]

Example 3

DN	MAC	Line Index	Partition
1000	PHONEMAC_C	2	PARTITION_X
1000	PHONEMAC_D	1	PARTITION_Y

1. Resolve => (DN:1000, Partition: <empty>)
Result: [PHONEMAC_D]
2. Resolve => (DN:1000, Partition: PARTITION_X)
Result: [PHONEMAC_C]

Example 4

DN	MAC	Line Index	Partition
1000	PHONEMAC_A	2	
1000	PHONEMAC_B	1	
1000	PHONEMAC_C	2	PARTITION_X
1000	PHONEMAC_D	1	PARTITION_Y

1. Resolve => (DN:1000, Partition: PARTITION_Z)
Result: not found
2. Resolve => (DN:1000, Partition: PARTITION_X)
Result: [PHONEMAC_C]

Shared Line Support

Cisco Unified Attendant Console Advanced provides full support for shared lines using device-based monitoring logic, which enables the user to view the state of a device, rather than just a single line in the main directory. For more information, see [Device-based Monitoring, page 6-10](#).

If two Cisco Unified Communications Manager End/Application Users have the same Telephone Number, they may both be allocated the same Device Name. This means that when an operator tries to see the state of either contact, the same DN/Device Name combination is requested, and they may not see the correct information.

To fix this issue you must amend the device name as described in [Amending Device Names, page 6-7](#).

Device-based Monitoring





























Cisco Unified Attendant Console Advanced provides the following levels of information:

- Device/phone status
- Line status for individual lines on the selected device.

Phone status information for each contact is shown in the main directory (F3) window. Irrespective of which line on a device is active, the attendant sees the Active  icon for the device. When the attendant presses F2 they are shown the status of each line on that device.

If a line is shared with another device with a different Device Name, that device is not shown as active in the F3 directory view. However, if the attendant uses F2 to view that device's line status, the line is shown as active.

The device and line states are shown in the table below:

Device State	Device	Directory View	F2 View of shared DN	Notes
Off Hook	Actual			
	Other			
Ringing Out	Actual			
	Other			
Connected	Actual			
	Other			
Hold	Actual			
	Other			
Ringing In	Actual			
	Other			
DND	Actual			Do Not Disturb shown against each line on the device
	Other			
Call Forward All*	Actual			Call Forward All icon is shown in Directory View only if both lines are primary lines. The icon is shown in F2 against each forwarded line.
	Other			



Presence Integration

Cisco Unified Attendant Console Advanced can use the following presence sources:

- Cisco Unified Presence (CUP)
- Cisco Unified IM and Presence
- Microsoft Office Communicator (MOC) and Lync
- Skype for Business

You can only use one presence source at a time.

This chapter describes the following:

- [Cisco IM&P Server Integration](#)
- [MOC and Lync Integration](#)

Cisco IM&P Server Integration

Figure 7-1 summarizes Cisco Unified Attendant Console Advanced integration with the CUP server (CUPS).

Figure 7-1 Cisco Unified Attendant Console Advanced Integration with CUPS

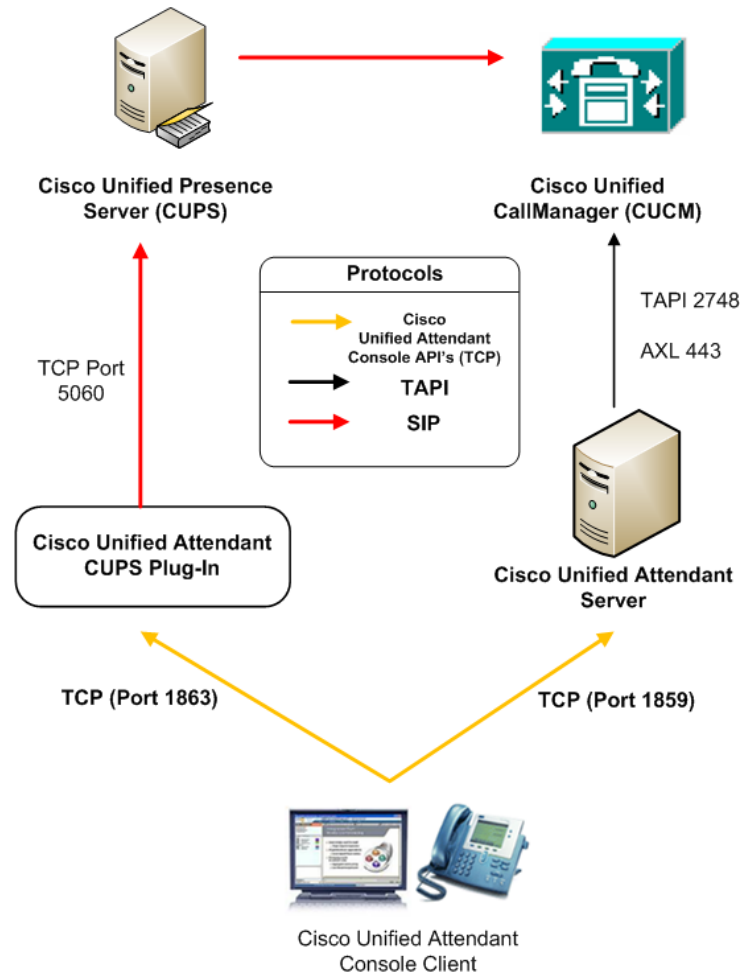

The CUPS plug-in connects to the CUPS using SIP SIMPLE protocol extensions. The Cisco Unified Attendant Console Advanced connects to the CUPS plug-in to manage presence status procurement.



Note

To be able to run the CUPS plug-in you must install the Microsoft .Net framework 2 Service Pack 1 or later. This is done automatically (if not already installed) when you install Cisco Unified Attendant Console Advanced.

For the CUPS plug-in to be able to request presence information, you must specify the Cisco Unified Attendant Console Advanced server as a *Incoming ACL* within the Cisco Unified Presence Server firewall configuration. You must then configure the CUPS plug-in using Cisco Unified Attendant Console Advanced Web Admin so that it can communicate with the CUPS and with all the Cisco Unified Attendant Console Advanced Clients. For information on how to do all this, see the *Cisco Unified Attendant Console Advanced Administration and Installation Guide*.

The CUPS configuration is stored in an XML file with the same name as the CUPS executable and the .config extension. For example, Cisco Presence server plug-in.exe.config.

MOC and Lync Integration

The Cisco Unified Attendant Console Advanced Clients can be configured to link to Microsoft Office Communicator Server (OCS versions 2007, 2007 R2 and Lync) APIs to display live presence and to exploit MOC functionality, such as instant messaging. The MOC Client must be installed on the same PC as the Cisco Unified Attendant Console Advanced Client.

The Cisco Unified Attendant Console Advanced Client and MOC Client communicate locally to get the status of each contact. If the presence status is available it is updated in the Cisco Unified Attendant Console Advanced as the attendant performs a search.



Note

The link is based on the contact's SIP address which may not be there email address.



Cisco Unity Voicemail Integration

Cisco Unified Communications Manager Release 8.0.3 can integrate with Cisco Unity Voicemail through:

- Voicemail Prefix
- Unified Messaging

It can then transfer data to Cisco Unified Attendant Console Advanced.

Within Cisco Unified Communications Manager you can configure a voicemail prefix which you enter to access the corresponding mailbox. For example, if the prefix is *, you dial *1002 to enter the mailbox of extension 1002. For more details of this functionality read the white paper at http://www.cisco.com/en/US/partner/products/sw/voicesw/ps556/products_tech_note09186a00800dea82.shtml.

Cisco Unified Attendant Console Advanced can use the Cisco Unified Communications Manager voicemail prefix to transfer calls directly to a contact's mailbox. When an attendant is connected to the call, they can right-click a contact to access the **Transfer to Voicemail** option. Clicking this option blind transfers the call to the contact's voice mailbox.

Configuring Cisco Unified Attendant Console Advanced Voicemail Access

To configure voicemail access in Cisco Unified Attendant Console Advanced, do the following:

-
- Step 1** Configure the voicemail prefix on Cisco Unified Communications Manager using the instructions in the Cisco white paper mentioned above.
 - Step 2** In Cisco Unified Attendant Console Advanced, choose **Options > Preferences**
 - Step 3** Select the **Dialling** tab, and set the **Voicemail Prefix** to match what is set on Cisco Unified Communications Manager (typically, this is *).
 - Step 4** Click **OK**.
-

Call Arrival Mode

Cisco Unified Attendant Console Advanced supports the following arrival modes:

- *Alerting* – incoming calls to CTI ports in the CT Gateway ring until they are answered by a console attendant.
- *Held* – calls answered on the CTI port can be put on hold and the caller played Music On Hold (MOH) while they are holding. Held calls are charged from the time they are answered and put on hold. You can also have Unity answer the call and play a welcome message, before using a call handler to transfer the call to the Queue DDI and play the caller music.



Note

The following points:

- The MOH source configured against Cisco Unified Attendant Console Advanced CTI ports *must* be set to *unicast*, otherwise call control issues may arise. *CTI devices do not support the multicast Music On Hold feature.*
 - Cisco Unified Communications Manager 8.0(3) and later enables you to configure a queue with Call Arrival Mode to **Hold Queued Calls when it arrives on the CTI Port**. This function places calls on hold so that Music on Hold can be played to the caller while they wait for an operator to answer. **If you use this mode the call is charged from the time that it is answered and put on hold on the CT Gateway.**
-



Antivirus and Remote Access Application Support

Cisco Unified Attendant Console Advanced server supports many antivirus products. You can find guidelines on antivirus software at:
http://www.cisco.com/en/US/prod/collateral/voicesw/ps6788/vcallcon/ps556/prod_bulletin0900aecd806f6221.html.

For more information about antivirus requirements and exclusions, see the *Cisco Unified Attendant Console Advanced Administration and Installation Guide*.

Remote Access Application Support

Cisco customer support staff often require remote access to the Cisco Unified Attendant Console Advanced server

The following remote access applications are supported by the Cisco Unified Attendant Console Advanced server:

- Real VNC
- Symantec pcAnywhere

Install the applications as per the manufacturers' instructions.



AXL/Database Field Mappings

This appendix lists the following AXL to Cisco Unified Communications Manager DB field mappings:

- [Phone Mappings](#)
- [CTI Route Point Mappings](#)
- [Directory Number \(Line\) Mappings](#)
- [Devicenumplanmap Mappings](#)

Phone Mappings

This table lists the mappings related to *Phone* in the DB *device* table.

AXL Tag	DB Field/ Default Value	CUCM Property (CTI Port only)
<name>	name	Device Name
<description>	description	Description
<product>	tkproduct CTI Port	N/A
<model>	tkmodel CTI Port	N/A
<class>	tkclass Phone	N/A
<protocol>	tkdeviceprotocol SCCP	N/A
<protocolSide>	tkprotocolside User	N/A
<callingSearchSpaceName>	fkcallingsearchspace	Calling Search Space
<devicePoolName>	fkdevicepool As per Cisco recommendations, this is the most used device pool.	Device Pool
<networkLocation>	tknetworklocation	N/A

AXL Tag	DB Field/ Default Value	CUCM Property (CTI Port only)
<locationName>	fklocation	Location
<commonDeviceConfigName>	Fkcommonphoneconfig	Common Device Configuration
<mediaResourceListName>	fkmediaresourcecelist	Media Resource Group List
<networkHoldMOHAudioSourceId>	networkholdmohaudiosourceid	Network Hold MOH Audio Source
<userHoldMOHAudioSourceId>	userholdmohaudiosourceid	User Hold MOH Audio Source
<automatedAlternateRoutingCSSName>	fkcallingsearchspace_aar	AAR Calling Search Space
<aarNeighborhoodName>	fkaarneighborhood	AAR Group
<mlppDomainId>	fkmlppdomain	MLPP Domain
<cgpnTransformationCSSName>	fkcallingsearchspace_cgpntransform	Calling Party Transformation CSS
<geoLocationName>	fkgeolocation	Geo Location
<joinAcrossLines>	tkstatus_joinacrosslines	Join Across Lines
<useTrustedRelayPoint>	tkstatus_usetrustedrelaypoint	Use Trusted Relay Point
<alwaysUsePrimeLine>	tkstatus_alwaysuseprimeline	Always Use Prime Line
<alwaysUsePrimeLineforVoiceMessage>	tkstatus_alwaysuseprimelineforvm	Always Use Prime Line for Voice Message
<userLocale>	tkuserlocale	User Locale
<builtInBridgeStatus>	tkstatus_builtinbridge	N/A
<callInfoPrivacyStatus>	tksipprivacy	Privacy
<hlogStatus>	Not known	N/A
<ownerUserId>	fkenduser	Owner User ID
<ignorePresentationIndicators>	ignorepi	Ignore Presentation Indicators (internal calls only)
<subscribeCallingSearchSpaceName>	fkcallingsearchspace_restrict	SUBSCRIBE Calling Search Space
<unattendedPort>	unattended_port	Unattended Port
<phoneSuite>	Not known	N/A
<deviceMobilityMode>	tkstatus_devicemobilitymode	Device Mobility Mode
<remoteDevice>	remotedevice	N/A
<dndOption>	tkdndoption	DND Option
<dndRingSetting>	tkdndoption	DND Incoming Call Alert
<dndStatus>	dndtimeout	Do Not Disturb
<label>	label	Line Text Label

CTI Route Point Mappings

This table lists the mappings related to *CTI Route Point* in the DB *device* table.

AXL Tag	DB Field/ Default Value	CUCM Property (CTI Port only)
<name>	name	Device Name
<description>	description	Description
<product>	tkproduct CTI Route Point	N/A
<model>	tkmodel CTI Route Point	N/A
<class>	tkclass CTI Route Point	N/A
<protocol>	tkdeviceprotocol SCCP	N/A
<protocolSide>	tkprotocolside User	N/A
<callingSearchSpaceName>	kcallingsearchspace	Calling Search Space
<devicePoolName>	fkdevicepool	Device Pool As per Cisco recommendations, this is the most used device pool.
<networkLocation>	tknetworklocation	N/A
<locationName>	fklocation	Location
<commonDeviceConfigName>	fkcommonphoneconfig	Common Device Configuration
<mediaResourceListName>	fkmediaresourcelist	Media Resource Group List
<networkHoldMOHAudioSourceId>	networkholdmohaudiosourceid	Network Hold MOH Audio Source
<userHoldMOHAudioSourceId>	userholdmohaudiosourceid	User Hold MOH Audio Source
<automatedAlternateRoutingCSSName>	fkcallingsearchspace_aar	AAR Calling Search Space
<aarNeighborhoodName>	fkaarneighborhood	AAR Group
<cgpnTransformationCSSName>	fkcallingsearchspace_cgpntransform	Calling Party Transformation CSS
<geoLocationName>	fkgeolocation	Geo Location

Directory Number (Line) Mappings

This table lists the mappings related to *Line* or *Directory Number* in the *dnorpattern* DB table.

AXL Tag	DB Field/ Default Value	CUCM Property (CTI Port only)
<pattern>	dnorpattern Directory number provided	Directory Number
<description>	description ASD-<Mac>-<DN>	Description
<usage>	tkpatternusage Conference	N/A
<routePartition>	fkroutepartition none	Route Partition
<aarNeighborhoodName>	fkaarneighborhood	AAR Group
<aarDestinationMask>	aardestinationmask	AAR Destination Mask
<aarKeepCallHistory>	aarkeepcallhistory	Retain this destination in the call forwarding history
<aarVoiceMailEnabled>	aarvoicemailenabled	Voice Mail
<presenceGroup>	fkmatrix_presence	Presence Group
<callForwardAll>		Forward All
<forwardToVoiceMail>	Cfaptvoicemailenabled	Voice Mail
<callingSearchSpace>	fkcallingsearchspace_cfapt	Calling Search Space
<secondaryCallingSearchSpace>	Not known	Secondary Calling Search Space for Forward All
<destination>	Cfaptdestination	Destination
<callForwardBusy>		Forward Busy External
<forwardToVoiceMail>	Cfbintvoicemailenabled	Voice Mail
<callingSearchSpace>	fkcallingsearchspace_cfbint	Calling Search Space
<destination>	Cfbintdestination	Destination
<callForwardBusyInt>		Forward Busy Internal
<forwardToVoiceMail>	cfbintvoicemailenabled	Voice Mail
<callingSearchSpace>	fkcallingsearchspace_cfbint	Calling Search Space
<destination>	cfbintdestination	Destination
<callForwardNoAnswer>		Forward No Answer External
<forwardToVoiceMail>	Cfnavoicemailenabled	Voice Mail

AXL Tag	DB Field/ Default Value	CUCM Property (CTI Port only)
<callingSearchSpace>	fkcallingsearchspace_cfnat	Calling Search Space
<destination>	Cfnadestination	Destination
<callForwardNoAnswerInt>		Forward No Answer Internal
<forwardToVoiceMail>	Cfnaintvoicemailenabled	Voice Mail
<callingSearchSpace>	fkcallingsearchspace_cfnaint	Calling Search Space
<destination>	Cfnaintdestination	Destination
<callForwardNoCoverage>		Forward No Coverage External
<forwardToVoiceMail>	Pffvoicemailenabled	
<callingSearchSpace>	fkcallingsearchspace_pff	
<destination>	pffdestination	
<callForwardNoCoverageInt>		Forward No Coverage Internal
<forwardToVoiceMail>	pffintvoicemailenabled	
<callingSearchSpace>	fkcallingsearchspace_pffint	
<destination>	pffintdestination	
<callForwardOnFailure>		Forward on CTI Failure
<forwardToVoiceMail>	Cfdvoicemailenabled	
<callingSearchSpace>	fkcallingsearchspace_devicefailure	
<destination>	Devicefailedn	
<callForwardNotRegistered>		Forward Unregistered External
<forwardToVoiceMail>	Cfurvoicemailenabled	
<callingSearchSpace>	fkcallingsearchspace_cfur	
<destination>	Cfurdestination	
<callForwardNotRegisteredInt>		Forward Unregistered Internal
<forwardToVoiceMail>	Cfurintvoicemailenabled	
<callingSearchSpace>	fkcallingsearchspace_cfurint	
<destination>	Cfurintdestination	
<callForwardAlternateParty>		MLPP Alternate Party Settings
<CallingSearchSpace>	fkcallingsearchspace_cfapt	MLPP Calling Search Space
<destination>	Cfaptdestination	Target (Destination)

AXL Tag	DB Field/ Default Value	CUCM Property (CTI Port only)
<duration>	cfaptduration	MLPP No Answer Ring Duration (seconds)
<callPickupGroup>	Not known	Call Pickup Group
<networkHoldMOHAudioSourceId>	networkholdmohaudiosourceid	Network Hold MOH Audio Source
<userHoldMOHAudioSourceId>	userholdmohaudiosourceid	User Hold MOH Audio Source
<alertingName>	alertingname	Alerting Name
<asciiAlertingName>	alertingnameascii	ASCII Alerting Name
<shareLineAppearanceCSS>	fkcallingsearchspace_sharedlineappear	N/A
<voiceMailProfile>	fkvoicemessagingprofile	Voice Mail Profile
<hrInterval>	hrInterval	Hold Reversion Notification Interval (seconds)
<hrDuration>	hrDuration	Hold Reversion Ring Duration (seconds)
<ParkMonForwardNoRetrieveDN>	parkmonforwardnoretrievedn	Park Monitoring Forward No Retrieve Destination External
<ParkMonForwardNoRetrieveIntDN>	parkmonforwardnoretrieveintdn	Park Monitoring Forward No Retrieve Destination Internal
<ParkMonForwardNoRetrieveVMEnabled>	parkmonforwardnoretrievevmenabled	Voice Mail
<ParkMonForwardNoRetrieveIntVMEnabled>	Parkmonforwardnoretrieveintvmenabled	Voice Mail
<ParkMonForwardNoRetrieveCSSName>	fkcallingsearchspace_pkmonfwdnoret	Calling Search Space
<ParkMonForwardNoRetrieveIntCSSName>	fkcallingsearchspace_pkmonfwdnoretint	Calling Search Space
<ParkMonReversionTimer>	Parkmonreversiontimer	Park Monitoring Reversion Timer
<partyEntranceTone>	tkstatus_partyentrancetone	Party Entrance Tone

Devicenumplanmap Mappings

This table lists the mappings related to the *Device* and *Line* join table (the properties appear on the Directory number GUI).

AXL Tag	DB Field/ Default Value	CUCM Property (CTI Port only)
<label>	label	Line Text Label
<display>	Display	Display (Internal Caller ID)
<displayASCII>	Displayascii	ASCII Display (Internal Caller ID)
<ringSetting>	tkringsetting_activepickupalert	N/A
<e164Mask>	e164mask	External Phone Number Mask
<dialPlanWizardId>	Dialplanwizardgenid	N/A

AXL Tag	DB Field/ Default Value	CUCM Property (CTI Port only)
<maxNumCalls>	maxnumcalls 2 for CTI Route point, 4 for CTI port	Maximum Number of Calls
<busyTrigger>	busytrigger 1 for CTI Route point, 2 for CTI port	Busy Trigger
<monitoringCSSName>	fkcallingsearchspace_monitoring	Monitoring Calling Search Space
<callInfoDisplay>	Callinfodisplaymask 9	Forwarded Call Information Display on Device