

Collaboration Endpoint software version 9.5  
SEPTEMBER 2018



# Administrator guide

for Cisco Webex Codec Pro

Thank you for choosing Cisco!

Your Cisco product has been designed to give you many years of safe, reliable operation.

This part of the product documentation is aimed at administrators working with the setup and configuration of the video system.

Our main objective with this Administrator guide is to address your goals and needs. Please let us know how well we succeeded!

May we recommend that you visit the Cisco web site regularly for updated versions of this guide.

The user documentation can be found on  
▶ <https://www.cisco.com/go/roomkit-docs>

## How to use this guide

The top menu bar and the entries in the Table of contents are all hyperlinks. You can click on them to go to the topic.

## Table of contents

<b>Introduction</b> .....	<b>4</b>
User documentation and software .....	5
What's new in CE9.....	6
Codec Pro at a glance .....	8
Power On and Off .....	9
LED behavior.....	10
How to administer the video system.....	11
<b>Configuration</b> .....	<b>15</b>
User administration .....	16
Change the system passphrase .....	17
Restrict the access to the Settings menu.....	18
System configuration .....	19
Add a sign in banner .....	20
Add a welcome banner.....	21
Manage the service certificates of the video system.....	22
Manage the list of trusted certificate authorities (CAs) .....	23
Set up secure audit logging .....	24
Manage pre-installed certificates for CUCM via Expressway provisioning.....	25
Delete CUCM trust lists.....	26
Change the persistency mode.....	27
Set strong security mode .....	28
Set up Intelligent Proximity for content sharing .....	29
Adjust the video quality to call rate ratio.....	34
Add corporate branding to the screen and Touch 10 user interface .....	36
Add a custom wallpaper .....	38
Choose a ringtone and set the ringtone volume .....	39
Manage the Favorites list .....	40
Set up accessibility features.....	41
<b>Peripherals</b> .....	<b>42</b>
Connect monitors .....	43
Connect input sources.....	45
Extend the number of input sources.....	47
Information about displays .....	48
Information about 4K resolution.....	49
Information about HDMI cables.....	50
Set up the SpeakerTrack feature .....	51
Set up the Snap to Whiteboard feature .....	52

Set up the PresenterTrack feature .....	55	Security settings .....	150
Briefing room set-up .....	60	SerialPort settings .....	153
Classroom set-up .....	66	SIP settings .....	154
Connect the Touch 10 controller .....	71	Standby settings .....	158
Connect the ISDN Link .....	75	SystemUnit settings .....	159
<b>Maintenance .....</b>	<b>76</b>	Time settings .....	160
Upgrade the system software .....	77	UserInterface settings .....	163
Add option keys .....	78	UserManagement settings .....	166
System status .....	79	Video settings .....	168
Run diagnostics .....	80	Experimental settings .....	179
Download log files .....	81	<b>Appendices .....</b>	<b>180</b>
Create a remote support user .....	82	How to use Touch 10 .....	181
Backup and restore configurations and custom elements .....	83	Set up remote monitoring .....	182
CUCM provisioning of custom elements .....	84	Access call information and answer a call while using the web interface .....	183
TMS provisioning of custom elements .....	85	Place a call using the web interface .....	184
Revert to the previously used software image .....	86	Share content using the web interface .....	186
Factory reset the video system .....	87	Local layout control .....	187
Factory reset Cisco Touch 10 .....	90	Control a local camera .....	188
Factory reset Cisco TelePresence Touch 10 .....	91	Control a far end camera .....	189
Capture user interface screenshots .....	92	Packet loss resilience - ClearPath .....	190
<b>System settings .....</b>	<b>93</b>	Room analytics .....	191
Overview of the system settings .....	94	Customize the video system's Touch 10 user interface .....	192
Audio settings .....	99	Customize the video system's behavior using macros .....	194
CallHistory settings .....	106	Input source composition .....	195
Cameras settings .....	107	Presentation source composition .....	197
Conference settings .....	114	Manage startup scripts .....	199
FacilityService settings .....	119	Access the video system's XML files .....	200
GPIO settings .....	120	Execute API commands and configurations from the web interface .....	201
H323 settings .....	121	Advanced customization of audio .....	202
Logging settings .....	124	Connector panel .....	203
Macros settings .....	125	Serial interface for maintenance .....	204
Network settings .....	126	Open TCP Ports .....	205
NetworkServices settings .....	133	Get a new HTTPFeedback address from TMS .....	206
Peripherals settings .....	140	Technical specification .....	207
Phonebook settings .....	142	Supported RFCs .....	209
Provisioning settings .....	143	User documentation on the Cisco web site .....	210
Proximity settings .....	146	Cisco contacts .....	211
RoomAnalytics settings .....	147		
RoomReset settings .....	148		
RTP settings .....	149		



## Chapter 1

# Introduction

## User documentation and software

### Products covered in this guide

- Cisco Webex Codec Pro

### User documentation

This guide provides you with the information required to administrate the video system.

The guide primarily addresses capabilities and configurations of on-premise registered video systems (CUCM, VCS), but a sub-set of the capabilities and configurations also applies to devices that are registered to our cloud service (Cisco Webex).

Refer to the ► [User documentation on the Cisco web site](#) appendix for more information about the guides for this product.

### Documentation on the Cisco web site

Visit the Cisco web site regularly for updated versions of the guides:

► <https://www.cisco.com/go/roomkit-docs>

### Documentation for cloud registered devices

For more information on Cisco Webex room devices, visit:

► <https://collaborationhelp.cisco.com>

### Cisco Project Workplace

Explore the Cisco Project Workplace to find inspiration and guidelines when preparing an office or meeting room for video conferencing:

► <https://www.cisco.com/go/projectworkplace>

### Software

Download software for the endpoint from the Cisco web site:

► <https://software.cisco.com/download/home>

We recommend reading the Software release notes (CE9):

► <https://www.cisco.com/c/en/us/support/collaboration-endpoints/spark-room-kit-series/tsd-products-support-series-home.html>

## What's new in CE9

This chapter provides an overview of the new and changed system settings, and the new features and improvements in the Cisco Collaboration Endpoint software version 9 (CE9) compared to CE9.4.

For more details, we recommend reading the Software release notes:

### New features and improvements in CE9.5

#### Presentation source composition

With using two or more content sources and sending them as one image, you can create a new experience for sharing in meetings.

This gives users more flexibility with what they present to remote sites. You can configure the presentation composition through in-room controls together with macros or an external controller.

The maximum number of different sources is determined by the device in use:

- *MX200 G2, MX300 G2, Room Kit, and SX20*: two sources
- *Room 55, Room 55 Dual, Room 70, and Room Kit Plus*: three sources
- *MX700, MX800, Room 70 G2, Room Kit Pro, and SX80*: four sources

You can only compose content that has been shared through a cable.

#### Audio Console on the web interface

The new Audio Console is natively available on the web interface. The audio console gives you simplified tools to route audio from an input to an output. The Audio Console replaces the old java-based CE Console that is no longer maintained.

When you access the Audio Console for the first time you will see the default system audio routes. The Audio Console is controlled by an underlying macro, which is saved and started once you select Choose to overwrite the current device configurations.

For more information, see the *CE Customization guide* at ► <https://www.cisco.com/go/in-room-control-docs>

#### Classroom set-up

The Classroom template uses macros to tailor a room set-up that works well for presenting and teaching scenarios. The template provides easy setup, management, and use of the room.

The Classroom set-up works similarly to the Briefing Room set-up, but it doesn't require three screens.

#### Support for Korean keyboard

Korean keyboard input is supported on Touch 10 when the user interface language is set to Korean.

#### Welcome banner

You can set up a welcome banner that users see after they sign in to the video system's web interface or command line interface. The banner can for example contain information you need in order to get started, or things you must be aware of when setting up the system.

## System configuration changes in CE9.5

### New configurations

Audio Input ARC [n] Mode  
Audio Output ARC [1] Delay DelayMs  
Audio Output ARC [1] Delay Mode  
Audio Output ARC [1] Mode  
NetworkServices SSH HostKeyAlgorithm

### Configurations that are removed

Audio Output InternalSpeaker Mode  
Provisioning RoomType ClassroomEnabled

### Configurations that are modified

Audio Ultrasound MaxVolume  
**OLD:** Default value: 70  
**NEW:** Default value: 60

Cameras PresenterTrack Connector  
**OLD:** Default value: 1  
**OLD:** Value space: Integer (1..5)  
**NEW:** Default value: 6  
**NEW:** Value space: Integer (1..6)

Video Input Connector [3,4,5] PreferredResolution  
**OLD:** Default value: 3840\_2160\_30  
**NEW:** Default value: 1920\_1080\_60

## Codec Pro at a glance

Cisco Webex Codec Pro, is a powerful collaboration solution that delivers up to 2160p60 end-to-end Ultra High Definition (UHD) video. The codec' has a rich set of video and audio inputs, flexible media engine and support for up to three screens. The Codec Pro is built for both cloud (Cisco Webex) and on-premise (CUCM and VCS) deployments. Codec Pro is suitable for large meeting rooms, boardrooms and purpose-built or vertical application rooms.

- Cisco Webex Room Kit Pro: Codec Pro, Cisco Quad Camera and Cisco Touch 10 user interface. External microphones are required. The Quad Camera has integrated loudspeakers and integrated microphones for speaker tracking; it detects meeting participants and shows the best overview; it detects and switches between active speakers (speaker tracking).
- Cisco Webex Room Kit Pro Precision 60: Codec Pro, Precision 60 camera and Cisco Touch 10 user interface. External microphones and loudspeakers are required. The Precision 60 camera is a flexible camera with magnetic pan and tilt, as well as optical zoom.
- Codec Pro can be used with SpeakerTrack 60 camera - Dual camera system featuring a unique direct, fast-switching approach for speaker tracking with two Precision 60 cameras.

## Features and benefits

- Automatic wake-up feature, detecting when someone walks into the room
- Can recognize people through their mobile device when the Webex app is installed
- Controlled by Cisco Touch 10, or with a Cisco Webex app-enabled device
- Support for 3 displays for video and content
- Support for 8 microphones, each with separate echo cancellers and noise reduction; all microphones can be set for balanced line level.
- Support for 6 balanced line level outputs
- Presentation of three content sources in local meetings
- 4K content sharing (30 fps in local meetings; 15 fps when sharing with far-end)
- Wired or wireless content sharing
- Counts people in the room, enabling analytics for better resource planning
- Ethernet and Wi-Fi support
- Controls peripherals such as lights and blinds through the Cisco Touch 10 (in-room control)

See the datasheet for more information:  
 ▶ <https://www.cisco.com/go/roomkit>

Cisco Webex Room Kit Pro

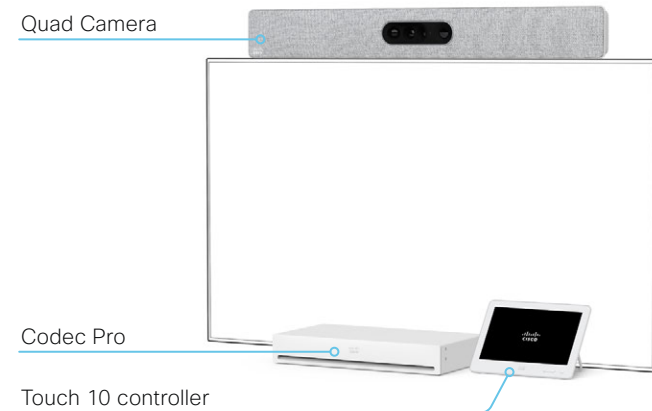

Cisco Webex Room Kit Pro Precision 60

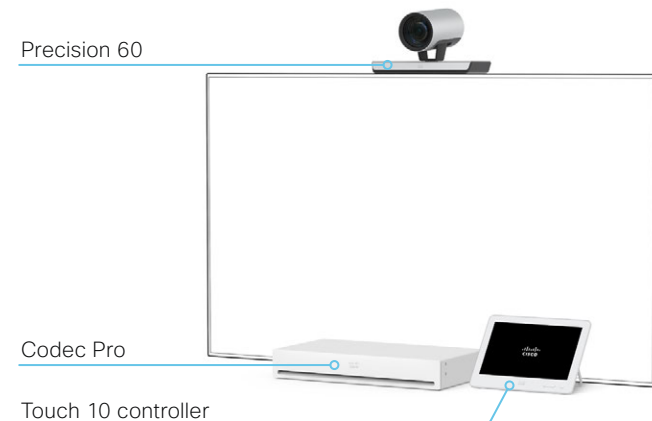



## Power On and Off

### Power On/Off with the Power switch

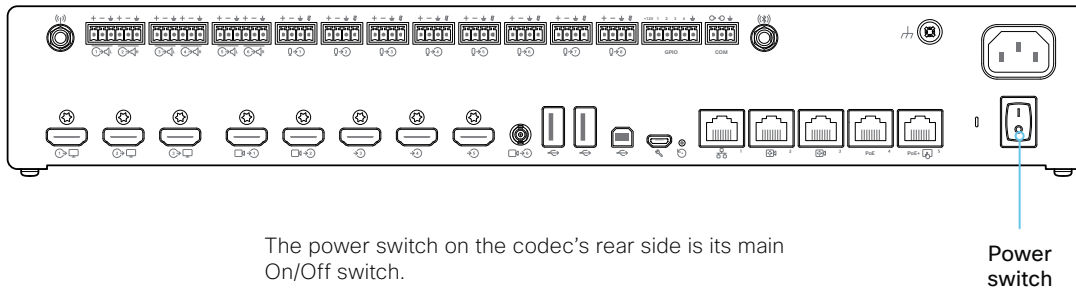

The power switch on the codec's rear side is its main On/Off switch.

It may take a few minutes for the codec to start up. The LED lights steadily when the system is ready for use.

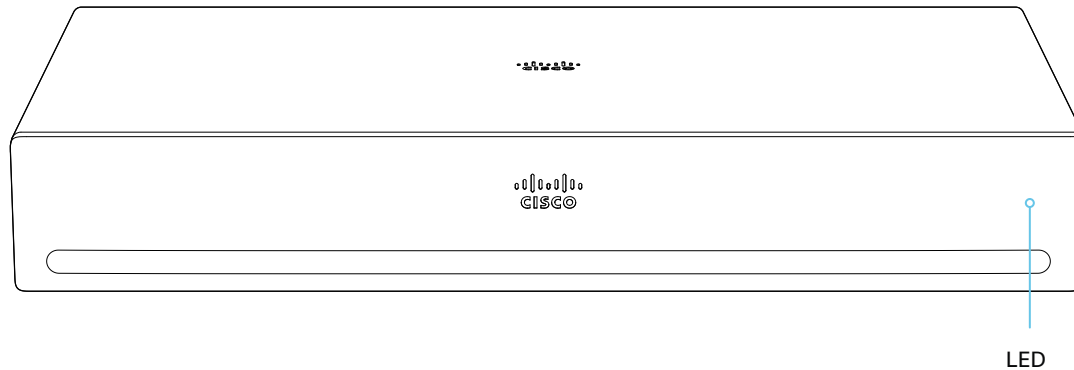

### Restart and standby using the user interface

#### Restart the system

1. Select the contact information in the upper left corner of the user interface.
2. Select [Settings](#), followed by [Restart](#).
3. Select [Restart](#) again to confirm your choice.

#### Enter/exit standby mode

1. Select the contact information in the upper left corner of the user interface.
2. Select [Standby](#).

### Power Off or restart the system remotely

Sign in to the web interface and navigate to [Maintenance > Restart](#).

#### Restart the system

Click [Restart device...](#) and confirm your choice.

It takes a few minutes before the system is ready for use.

#### Power Off the system

Click [Shutdown device...](#) and confirm your choice.

-  You cannot power the system on again remotely. For the system to power up after a remote shutdown, turn the power switch Off and then On.

## LED behavior

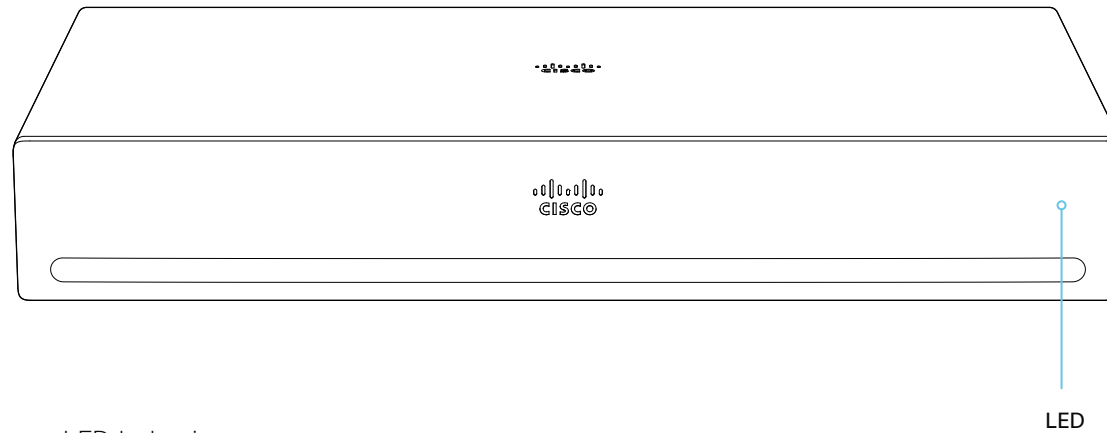

### LED behavior

*In idle mode (screens are awake):*

Steady light.

*In standby mode (screens are off):*

Steady light.

*The system needs attention (e.g. no network connection):*

The LED repeatedly flashes twice.

*During startup (boot):*

The LED flashes. It turns steady when the system is ready for use.

## How to administer the video system (page 1 of 4)

In general, we recommend you to use the web interface to administer and maintain the video system, as described in this administrator guide.

Alternatively, you can access the API of the video system by other methods:

- HTTP or HTTPS (also used by the web interface)
- SSH
- Serial interface (RS-232)

If you want more information about the different access methods, and how to use the API, refer to the *API guide* for the video system.

### Tip

If the configuration or status is available in the API, the web interface setting or status translates into an API configuration or status as follows:

Set `X > Y > Z` to **Value** (web)  
is the same as  
`xConfiguration X Y Z: Value` (API)

Check `X > Y > Z` status (web)  
is the same as  
`xStatus X Y Z` (API)

For example:

Set `SystemUnit > Name` to **MySystem**  
is the same as  
`xConfiguration SystemUnit Name: MySystem`

Check `SystemUnit > Software > Version` status  
is the same as  
`xStatus SystemUnit Software Version`

More settings and statuses are available in the web interface than in the API.

Access method	Notes	How to enable/disable the methods
<b>HTTP/HTTPS</b>	<ul style="list-style-type: none"> <li>• Used by the web interface of the video system</li> <li>• Non-secure (HTTP) or secure (HTTPS) communication</li> <li>• HTTPS: <i>Enabled</i> by default</li> <li>• HTTP: <i>Enabled</i> by default only for video systems that have been upgraded to CE9.4 (or later) from an earlier software version, provided that the video system has not been factory reset after the upgrade.</li> </ul>	<p><a href="#">NetworkServices &gt; HTTP &gt; Mode</a></p> <p>Restart the video system for changes to take effect</p>
<b>SSH</b>	<ul style="list-style-type: none"> <li>• Secure TCP/IP connection</li> <li>• <i>Enabled</i> by default</li> </ul>	<p><a href="#">NetworkServices &gt; SSH &gt; Mode</a></p> <p>You do not need to restart the video system. It may take some time for changes to take effect</p>
<b>Serial interface (RS-232)</b>	<ul style="list-style-type: none"> <li>• Connect to the video system with a cable. IP-address, DNS, or a network is not required</li> <li>• <i>Enabled</i> by default</li> <li>• For security reasons, you are asked to sign in by default (<a href="#">SerialPort &gt; LoginRequired</a>)</li> </ul>	<p><a href="#">SerialPort &gt; Mode</a></p> <p>Restart the video system for changes to take effect</p>



If all access methods are disabled (set to **Off**), you can no longer configure the video system. You are not able to re-enable (set to **On**) any of the access methods, and you must factory reset the video system to recover.

How to administer the video system (page 2 of 4)

## The web interface of the video system

The web interface is the administration portal for the video system. You can connect from a computer and administer the system remotely. It provides full configuration access and offers tools and mechanisms for maintenance.

**Note:** The web interface requires that HTTP or HTTPS is enabled (refer to [NetworkServices > HTTP > Mode](#) setting).

We recommend that you use the latest release of one of the major web browsers.

### Connect to the video system

Open a web browser and enter the IP address of the video system in the address bar.



#### How to find the IP address

1. Select the contact information in the upper left corner of the user interface.
2. Select [Settings](#), followed by [About this device](#).

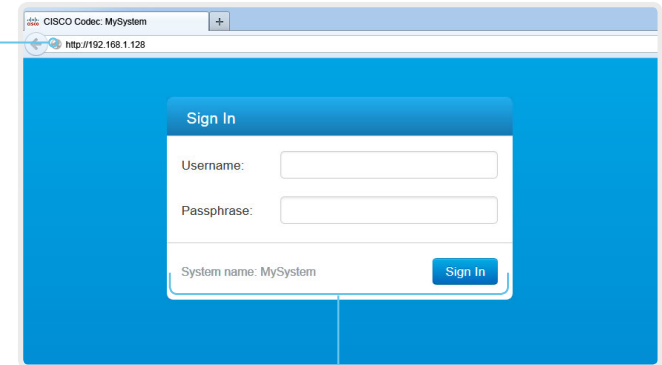

### Sign in

Enter user name and passphrase for the endpoint and click [Sign In](#).



The system is delivered with a default user named *admin* with no passphrase. Leave the [Passphrase](#) field blank when signing in for the first time.

It is mandatory to set a password for the *admin* user.

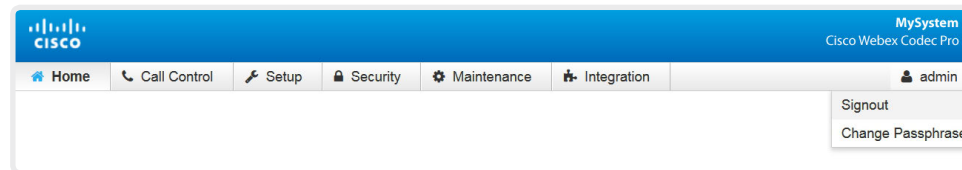

### Sign out

Hover the mouse over the user name and choose [Signout](#) from the drop-down list.

How to administer the video system (page 3 of 4)

## How the web interface is organized

The web interface is organized in sub-pages. All sub-pages shown below are available if the video system is registered to an on-premise service (CUCM, VCS); the pages shown in grey color are not available if the video system is registered to the Cisco cloud service (Cisco Webex).

In both cases, a user that is signed in, sees only the pages that he has access rights for.

Read more about user administration, user roles and access rights in the [User administration](#) chapter.

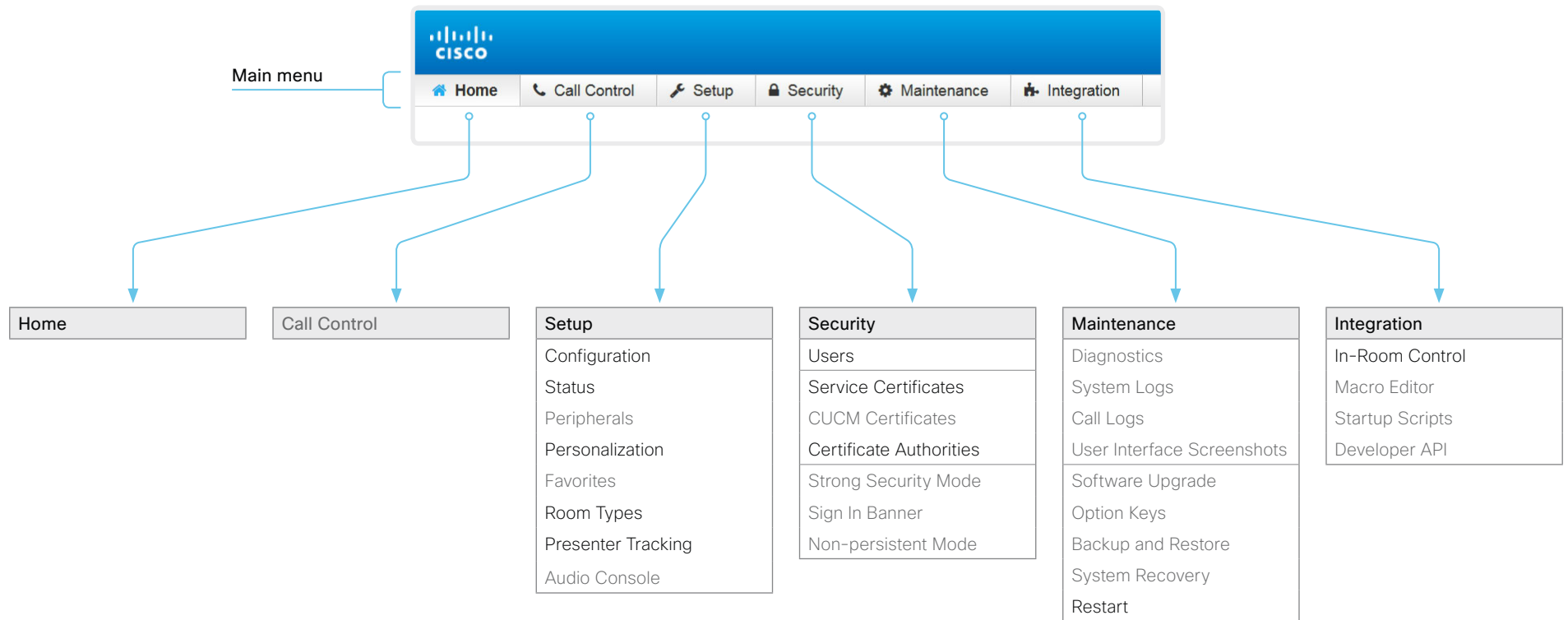

How to administer the video system (page 4 of 4)

## Settings and system information on the user interface

You have access to system information, and some basic configurations and system tests on the video system's user interface.

System-critical settings and functions, such as network settings, service activation, and factory reset, may be protected by a passphrase, refer to the ► [Restrict the access to the Settings menu](#) chapter.

Some of the settings and tests are also part of the *Setup assistant* that is launched when the video system is powered up for the first time. The Setup assistant is described in the *Getting Started Guide* for systems running CE software.

### Access Settings

1. Select the contact information in the upper left corner of the user interface.
2. Select [Settings](#).

A padlock symbol  indicates that a setting is protected (locked down).

3. Select the setting you want to change, or the test you want to run.

If a setting is locked down, an authentication window pops up, and you have to sign in with ADMIN credentials to proceed.



## Chapter 2

# Configuration

## User administration

You have to sign in to get access to the web and command line interfaces. You can assign different roles to users, to determine what they should have access to.

### The default user account

The video system comes with a default administrator user account with full access rights. The user name is *admin* and no passphrase is initially set.



It is mandatory to set a passphrase for the *admin* user.

Read how to set the passphrase in the [► Change the system passphrase](#) chapter.

### Create a new user account

1. Sign in to the web interface, and navigate to [Security > Users](#).
2. Click [Add new user...](#)
3. Fill in the *Username*, *Passphrase* and *Repeat passphrase* input fields.  
As a default, the user has to change the passphrase when he signs in for the first time.  
Fill in the *Client Certificate DN* (Distinguished Name) field only if you use client certificates for authentication.
4. Check the appropriate *Roles* check boxes.  
If you assign the ADMIN role to a user, enter your own passphrase in the *Your passphrase* input field for verification.
5. Set the *Status* to **Active** to activate the user.
6. Click [Create User](#).  
Use the [Back](#) button to leave without making any changes.

### Edit an existing user account

If you make changes to a user that holds the Admin role, you must always enter your own passphrase in the *Your passphrase* input field for verification.

#### Change the user privileges

1. Sign in to the web interface, and navigate to [Security > Users](#).
2. Click the appropriate user in the list.
3. Choose user roles, set the status to **Active** or **Inactive**, and decide if the user has to change the passphrase on the next sign in.  
Fill in the *Client Certificate DN* (Distinguished Name) field only if you use certificate login on HTTPS.
4. Click [Edit User](#) to save the changes.  
Use the [Back](#) button to leave without making any changes.

#### Change the passphrase

1. Sign in to the web interface, and navigate to [Security > Users](#).
2. Click the appropriate user in the list.
3. Enter the new passphrase in the appropriate input fields.
4. Click [Change passphrase](#) to save the change.  
Use the [Back](#) button to leave without making any changes.

#### Delete the user account

1. Sign in to the web interface, and navigate to [Security > Users](#).
2. Click the appropriate user in the list.
3. Click [Delete user...](#) and confirm when prompted.

### User roles

A user account may hold one or a combination of *user roles*. A user account with full access rights, like the default *admin* user, should possess the ADMIN, USER and AUDIT roles.

These are the *user roles*:

**ADMIN:** A user with this role can create new users, change most settings, make calls, and search the contact lists. The user cannot upload audit certificates and change the security audit settings.

**USER:** A user with this role can make calls and search the contact lists. The user can modify a few settings, for example adjust the ringtone volume and set the time and date format.

**AUDIT:** A user with this role can change the security audit settings and upload audit certificates.

**ROOMCONTROL:** A user with this role can create in-room controls. The user has access to the In-room control editor and corresponding development tools.

**INTEGRATOR:** A user with this role has access to settings, commands and status that are required to set up advanced AV scenarios, and to integrate our video systems with 3<sup>rd</sup> party equipment. Such a user can also create in-room controls.

### Cisco Webex registered systems

If a video system is registered to Cisco's cloud service (Cisco Webex), only local users with the INTEGRATOR and ROOMCONTROL user roles are available.



## Change the system passphrase

You need to know the system passphrase in order to:

- Sign in to the web interface
- Sign in and use the command line interfaces

### The default user account

The video system is delivered with a default user account with full access rights. The user name is *admin*, and initially, no passphrase is set.

 It is mandatory to set a passphrase for the default *admin* user in order to restrict access to system configuration. It is also mandatory to set a passphrase for any other user with ADMIN rights.

A warning, saying that the system passphrase is not set, is shown on screen until a passphrase is set for the *admin* user.

### Other user accounts

You can create many user accounts for the video system.

Read more about how to create and manage user accounts in the [User administration](#) chapter.

## Change your passphrase

1. Sign in to the web interface, hover the mouse over the user name, and choose [Change Passphrase](#) in the drop down list.
2. Enter the current passphrase and new passphrase in the input fields, and click [Change passphrase](#).

The passphrase format is a string with 0–64 characters.

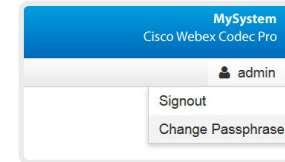

 If the passphrase currently is not set, leave the [Current passphrase](#) field blank.

## Change another user's passphrase

If you have administrator access rights, you can change the password of any user.

1. Sign in to the web interface, and navigate to [Security > Users](#).
2. Click the appropriate user in the list.
3. Enter the new passphrase in the *Passphrase* and *Repeat passphrase* input fields.  
If the user holds the Admin role, you must enter your own passphrase in the *Your passphrase* input field for verification.
4. Click [Change passphrase](#) to save the change.  
Use the [Back](#) button to leave without making any changes.

## Restrict the access to the Settings menu

By default, any user has access to the Settings menu on the user interface.

We recommend that you restrict the access to prevent unauthorized users from changing the configuration of the video system.

### Lock down the Settings menu

1. Sign in to the web interface, and navigate to [Setup > Configuration](#).
2. Go to [UserInterface > SettingsMenu > Mode](#), and select **Locked**.
3. Click [Save](#) for the change to take effect.

Now a user has to sign in with ADMIN credentials to get access to the system-critical settings on the user interface (Touch controller).

### Unlock the Settings menu

1. Sign in to the web interface, and navigate to [Setup > Configuration](#).
2. Go to [UserInterface > SettingsMenu > Mode](#), and select **Unlocked**.
3. Click [Save](#) for the change to take effect.

Now any user has access to the complete Settings menu on the user interface (Touch controller).

### The Settings menu on the user interface

If the menu is locked down, you must sign in to access the system-critical settings.

Select the contact information in the upper left corner of the user interface followed by [Settings](#), in order to open the Settings menu.

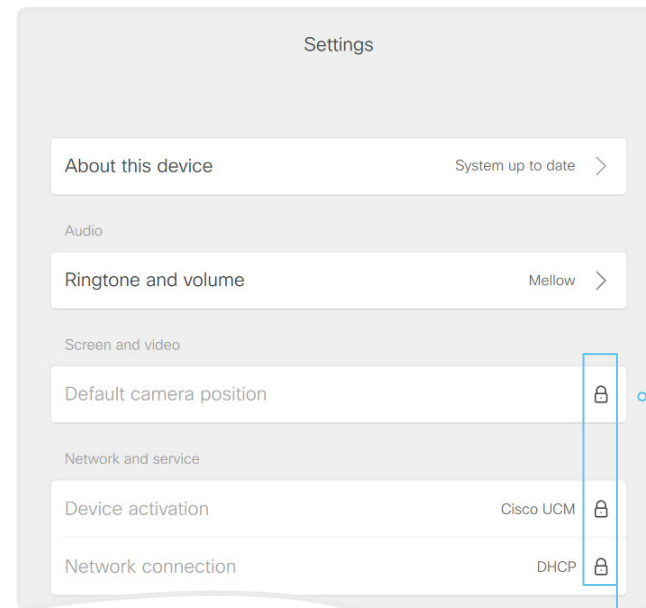

#### Locked down settings

Locked down settings are marked with a padlock.

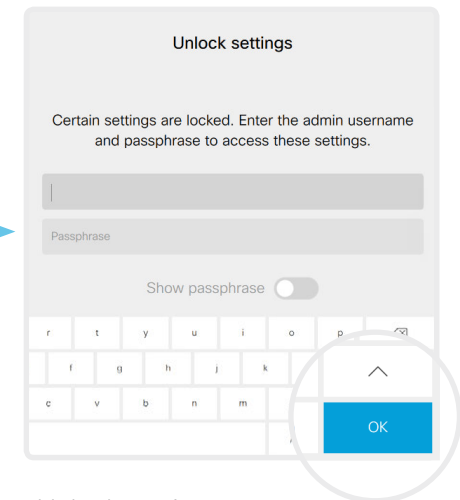

#### Unlock settings

If you click on the padlock, you are asked to sign in with an ADMIN user.

Once signed in, you can access all settings until you close the Settings menu.

## System configuration

Sign in to the web interface, and navigate to [Setup > Configuration](#).

### Find a system setting

#### Search for settings

Enter as many letters as needed in the search field. All settings that contain these letters are shown in the right pane. Settings that have these letters in their value space are also shown.

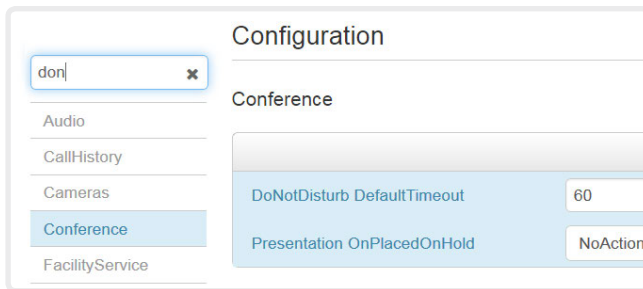

#### Select a category and navigate to settings

The system settings are grouped in categories. Choose a category in the left pane to show the associated settings.

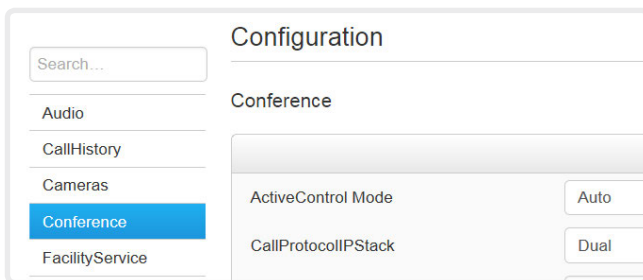

### Change a system setting

#### Check the value space

A settings's value space is specified either by text following the input field or in a drop-down list that opens when you click the arrow.

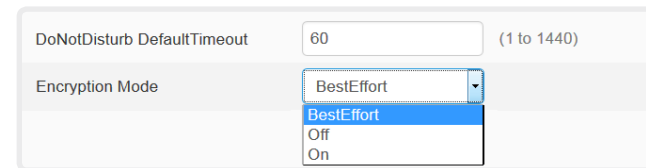

#### Change a value

1. Choose the preferred value from the drop-down list, or enter new text in the input field.
2. Click [Save](#) for the change to take effect.

Use the [Undo](#) or [Revert](#) buttons if you do not want to make any changes.

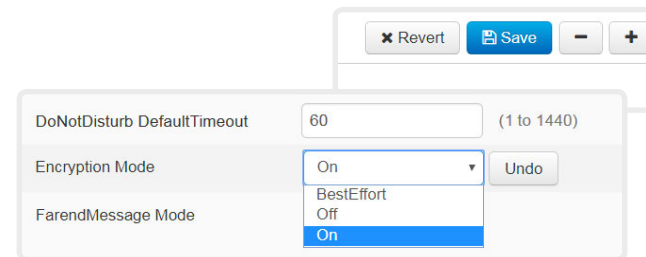

Categories with unsaved changes are marked with an edit symbol (✎).

### About system settings

All system settings can be changed from the web interface.

Each system setting is described in the [System settings](#) chapter.

Different settings may require different user credentials. In order to be sure that an administrator is able to change all system settings, an administrator user must possess all user roles.

You can read more about user administration and user roles in the [User administration](#) chapter.

## Add a sign in banner

Sign in to the web interface, and navigate to [Security > Sign In Banner](#).

1. Enter the message that you want to present to the user when he signs in.
2. Click [Save](#) to activate the banner.

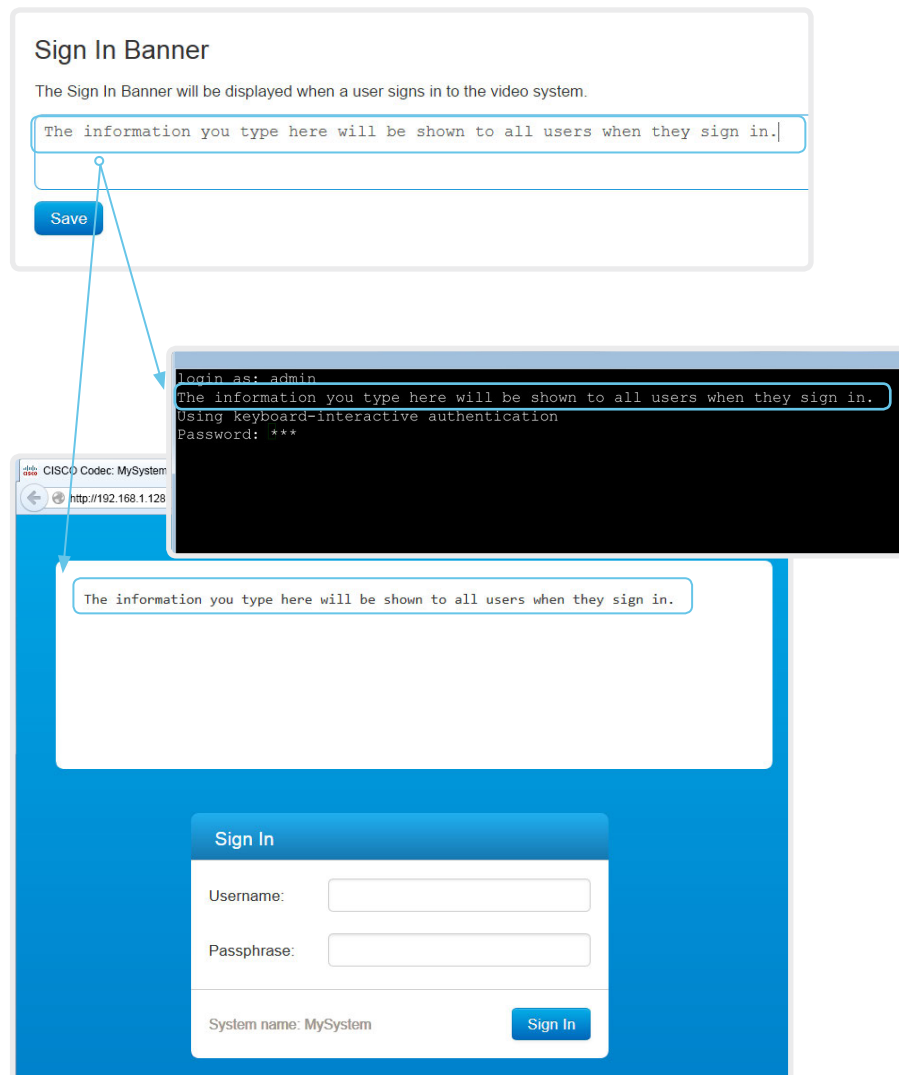

### About sign in banner

If a system administrator wants to provide initial information to all users, he can create a sign in banner. The message is shown when the user signs in to the web interface or the command line interface.

The maximum size is: 4 kByte

### Welcome banner versus sign in banner

Sign in banner:

- The banner is shown *before* the user signs in to the web interface or the command line interface.

Welcome banner:

- The banner is shown *after* the user has signed in to the web interface or the command line interface.

## Add a welcome banner

Adding a Welcome banner is only available using API commands; we don't provide a dedicated user interface for it.

### API commands

```
xCommand SystemUnit WelcomeBanner Set
```

This is a multiline command. Anything you input after you issue the command, is input to the command (including line breaks). Finish the input with a separate line containing just a period ending with a line break.

There are also a few more welcome banner commands, refer to the API-guide for more details.

```
xCommand SystemUnit WelcomeBanner Clear
```

```
xCommand SystemUnit WelcomeBanner Get
```

### Example

```
xCommand SystemUnit WelcomeBanner Set <enter>
```

```
This is a welcome banner. <enter>
```

```
A welcome banner may have multiple lines. <enter>
```

```
. <enter>
```

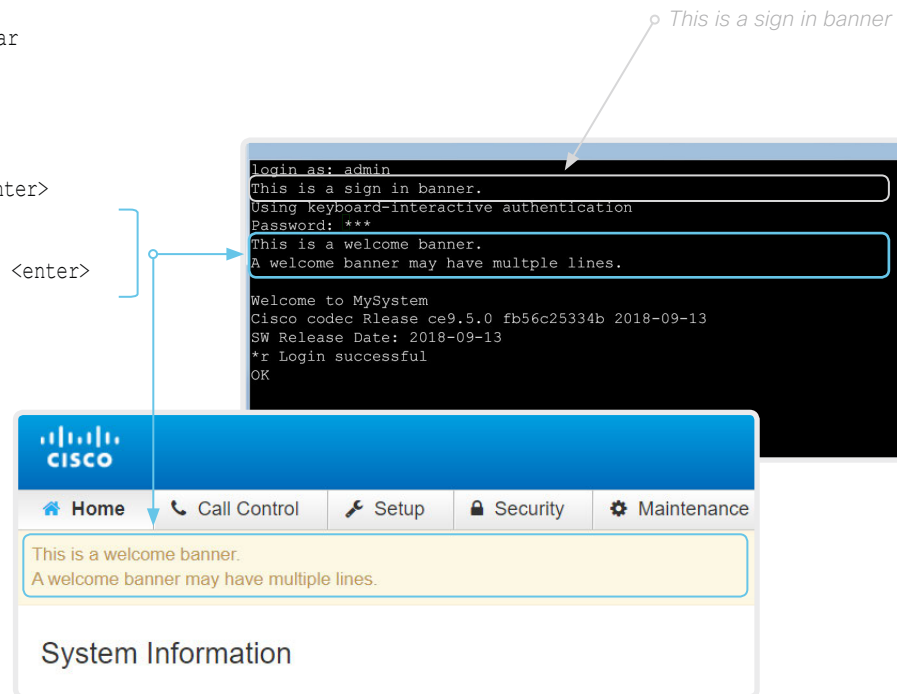

### About welcome banner

You can set up a welcome banner that users see after they sign in to the video system's web interface or command line interface. The banner can have multiple lines.

The banner can for example contain information you need in order to get started, or things you must be aware of when setting up the system.

The maximum size is: 4 kByte

### Welcome banner versus sign in banner

Sign in banner:

- The banner is shown *before* the user signs in to the web interface or the command line interface.

Welcome banner:

- The banner is shown *after* the user has signed in to the web interface or the command line interface.

## Manage the service certificates of the video system

Sign in to the web interface and navigate to [Security > Service Certificates](#).

You need the following files:

- Certificate (file format: .PEM)
- Private key, either as a separate file or included in the same file as the certificate (file format: .PEM format)
- Passphrase (required only if the private key is encrypted)

The certificate and the private key will be stored in the same file on the video system.

### About the service certificates of the video system

Certificate validation may be required when using TLS (Transport Layer Security).

A server or client may require that the video system presents a valid certificate to them before communication can be set up.

The video system's certificates are text files that verify the authenticity of the system. These certificates may be issued by a certificate authority (CA).

Certificates are used for the following services: HTTPS server, SIP, IEEE 802.1X and audit logging.

You can store many certificates on the video system, but only one certificate can be enabled for each service at a time.

If authentication fails, the connection will not be established.

Enable or disable, view or delete a certificate

Use the On and Off buttons to enable or disable a certificate for the different services.

Use the corresponding button to view or delete a certificate.

Certificate	Issuer	802.1X	Audit	HTTPS	SIP		
Certificate_A	CertificateAuthority_A	Off	Off	Off	Off	Delete	View Certificate
Certificate_B	CertificateAuthority_B	On	Off	Off	Off	Delete	View Certificate

**Add Certificate**

Certificate  No file selected.

Private key (optional)  No file selected.

Passphrase (optional)

This system supports PEM formatted certificate files (.pem). The certificate file may contain the certificate and a RSA or DSA encrypted private key with or without a passphrase. Optionally the private key file may be supplied separately.

The certificates and certificate issuers in the illustration are examples. Your system has other certificates.

### Add a certificate

1. Browse to find the Certificate file and Private key file (optional) on your computer.
2. Fill in the *Passphrase* if required.
3. Click [Add certificate...](#) to store the certificate on the video system.

## Manage the list of trusted certificate authorities (CAs)

Sign in to the web interface, navigate to [Security > Certificate Authorities](#), and open the [Custom CAs](#) tab.

You need the following file:

- CA certificate list (file format: .PEM).

### View or delete a certificate

Use the corresponding button to view or delete a certificate.

### Upload a list of certificate authorities

1. Browse to find the file containing a list of CA certificates on your computer (file format: .PEM).
2. Click [Add certificate authority...](#) to store the new CA certificates on the video system.

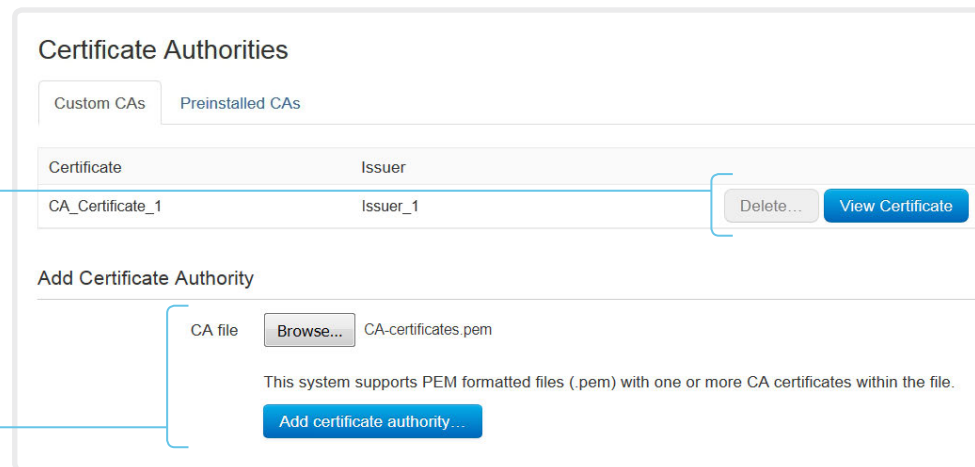

The certificates and certificate issuers in the illustration are examples. Your system has other certificates.



Previously stored certificates are not deleted automatically.

The entries in a new file with CA certificates are appended to the existing list.

### About trusted CAs

Certificate validation may be required when using TLS (Transport Layer Security).

The video system may be set up to require that a server or client presents its certificate to the video system before communication can be set up.

The certificates are text files that verify the authenticity of a server or client. The certificates must be signed by a trusted CA.

In order to verify the signature of the certificates, a list of trusted CAs must reside on the video system.

The list must include all CAs needed in order to verify certificates for both audit logging and other connections.

If authentication fails, the connection will not be established.

## Set up secure audit logging

Sign in to the web interface, navigate to [Setup > Configuration](#).



The certificate authority (CA) that verifies the certificate of the audit server must be in the video system's list of trusted certificate authorities. Otherwise, logs will not be sent to the external server.

Refer to the [Manage the list of trusted certificate authorities \(CAs\)](#) chapter how to update the list.

1. Open the [Security](#) category.
2. Find the [Audit > Server](#) settings, and enter the [Address](#) of the audit server.  
If you set [PortAssignment](#) to **Manual**, you must also enter a [Port](#) number for the audit server.
3. Set [Audit > Logging > Mode](#) to **ExternalSecure**.
4. Click [Save](#) for the change to take effect.

The screenshot shows the 'Configuration' window for 'Security'. The 'Audit' section is expanded, revealing the following settings:

- Logging Mode:** A dropdown menu with 'ExternalSecure' selected. An 'Undo' button is to its right.
- OnError Action:** A dropdown menu with 'ExternalSecure' selected.
- Server:** A sub-section containing:
  - Address:** An empty text input field with an 'Undo' button and '(0 to 255 characters)' to its right.
  - Port:** A text input field containing '514' with '(0 to 65535)' to its right.
  - PortAssignment:** A dropdown menu with 'Auto' selected.

### About secure audit logging

When audit logging is enabled, all sign in activity and configuration changes on the video system are recorded.

Use the [Security > Audit > Logging > Mode](#) setting to enable audit logging. Audit logging is disabled by default.

In ExternalSecure audit logging mode the video system sends encrypted audit logs to an external audit server (syslog server), which identity must be verified by a signed certificate.

The signature of the audit server is verified using the same CA list as other servers/clients.

If the audit server authentication fails, no audit logs are sent to the external server.



## Manage pre-installed certificates for CUCM via Expressway provisioning

Sign in to the web interface, navigate to [Security > Certificate Authorities](#), and open the [Preinstalled CAs](#) tab.

**Certificate Authorities**

Custom CAs | **Preinstalled CAs**

This CA list is used for Cisco UCM via Expressway (Edge) provisioning only.  
[Configure provisioning now.](#)

These certificates are used to validate the servers contacted over the Internet when the endpoint uses Cisco UCM via Expressway provisioning.

Certificate	Issuer		
Certificate_01	Issuer_1	Details...	Disable
Certificate_02	Issuer_2	Details...	Disable
Certificate_03	Issuer_3	Details...	Disable

Disable All

### View or disable certificates

Use the [Details...](#) and [Disable](#) buttons respectively, to view or disable certificates.



As an alternative to using the pre-installed certificates, you can append the certificates you need to the certificate list manually.

Refer to the [Manage the list of trusted certificate authorities \(CAs\)](#) chapter how to update the list of trusted certificates.

### About pre-installed certificates

The pre-installed certificates in this list are only used when the video system is provisioned by Cisco Unified Communications Manager (CUCM) via Expressway (Edge).

Only Cisco Expressway infrastructure certificates are checked against this list.

If the validation of the Cisco Expressway infrastructure certificate fails, the video system will not be provisioned and registered.

Factory resetting the video system does not delete the list of pre-installed certificates.

## Delete CUCM trust lists

The information in this chapter is only relevant for video systems that are registered to a Cisco Unified Communications Manager (CUCM).

Sign in to the web interface, navigate to [Security > CUCM Certificates](#).

### Delete the CUCM trust lists

Click [Delete CTL/ITL](#) to remove the trust lists.

 As a general rule, you should not delete old CTL (Certificate Trust List) and ITL (Initial Trust List) files.

In these cases, you must still delete them:

- When you change the CUCM IP address.
- When you move the endpoint between CUCM clusters.
- When you need to re-generate or change the CUCM certificate.

### Overview of trust list fingerprints and certificates

The trust lists' fingerprints and an overview of the certificates in the lists are displayed on the web page.

This information may be useful for troubleshooting.

### More information about trust lists

For more information about CUCM and trust lists, read the *Deployment guide for TelePresence endpoints on CUCM* that is available on the Cisco web site.

## Change the persistency mode

Sign in to the web interface and navigate to [Security > Non-persistent Mode](#).

### Check the persistency status

The active radio buttons show the current persistency status of the video system.

Alternatively, you can navigate to [Setup > Status](#), and then open the [Security](#) category to see the [Persistency](#) status.

### Change the persistency settings

All persistency settings are set to **Persistent** by default. You only have to change these settings if you want to make them **Non-persistent**.

1. Click the radio buttons to set the persistency for configurations, call history, internal logging, local phonebook (local directory and favorites) and IP connectivity (DHCP) information.
2. Click [Save and reboot...](#)

The video system restarts automatically. After the restart, the behavior changes according to the new persistency settings.



Logs, configurations, and other data that was stored before you switched to Non-persistent mode, are NOT cleared or deleted.

### Persistency mode

Configurations, call history, internal logs, local phonebook (local directory and favorites list), and IP connectivity information are stored by default. Because all persistency settings are set to **Persistent**, a system restart does not delete this information.

Generally, we recommend you NOT to change the persistency settings. Only change to **Non-persistent** mode if you have to prevent users from being able to see or traceback to any logged information from the previous session

In Non-persistent mode, the following information is lost or cleared each time the system restarts:

- System configuration changes
- Information about placed and received calls (call history)
- Internal log files
- Changes to the local contacts or favorites list
- All IP related information (DHCP) from the last session



Information that was stored before changing to Non-persistent mode is not automatically cleared or deleted. You must factory reset the video system to delete such information.

There is more information about performing a factory reset in the [▶ Factory reset the video system](#) chapter.

## Set strong security mode

Sign in to the web interface, navigate to [Security > Strong Security Mode](#).

### Set strong security mode

Read carefully about the consequences of strong security mode before you continue.

1. If you want to use strong security mode, click [Enable Strong Security Mode...](#) and confirm your choice in the dialog box that appears.  
The video system restarts automatically.
2. Change the passphrase when you are prompted. The new passphrase must meet the strict criteria as described.

How to change the system passphrase is described in the [Change the system passphrase](#) chapter.

### Return to normal mode

Click [Disable Strong Security Mode...](#) in order to restore the video system to normal mode. Confirm your choice in the dialog box that appears.

The video system restarts automatically.

### Strong Security Mode

Strong Security Mode is **not** enabled.

Strong Security Mode is required to adhere to U.S. Department of Defense JITC regulations.

It will introduce the following:

- All users and administrators must change their passphrase and PIN on the next sign in
- New passphrases must meet the following criteria:
  - Minimum 15 characters
  - Minimum 2 uppercase alphabetic characters
  - Minimum 2 lowercase alphabetic characters
  - Minimum 2 numerical characters
  - Minimum 2 non-alphanumeric (special) characters
  - No more than 2 consecutive characters may be the same
  - Must be different from the last 10 previous passphrases used
  - Not more than 2 characters from the previous passphrase can be in the same position
- Passphrases must be changed at least every 60 days
- Passphrases cannot be changed more than once per 24 hours
- 3 failed signins will lock the user account until an administrator re-activates the account

[Enable Strong Security Mode...](#)

### Strong Security Mode

Strong Security Mode is enabled.

[Disable Strong Security Mode...](#)

### About strong security mode

Use strong security mode only when compliance with DoD JITC regulations is required.

Strong security mode sets very strict passphrase requirements, and requires all users to change their passphrase on the next sign in.

## Set up Intelligent Proximity for content sharing (page 1 of 5)

Cisco Proximity allows users to see, control, capture and share content directly on their own mobile devices (smartphone, tablet, or laptop), when the device is near a video system.

The mobile device can automatically pair with the video system when it comes within range of ultrasound transmitted by the video system.



The number of simultaneous Proximity connections depends on the type of video system. The client warns new users if the maximum number of connections has been reached.

Video system	Maximum number of connections
Room Kit, Room 55, Room 55 Dual, Room 70, Room 70 G2	30 / 7 *
Codec Plus, Codec Pro	30 / 7 *
SX80	10
SX10, SX20	7
MX700, MX800	10
MX200 G2, MX300 G2	7
DX70, DX80	3

\* 30 connections when the *View shared content on a mobile device* Proximity service is disabled; 7 connections when this service is enabled.

### Proximity services

*Place calls and control the video system:*

- Dial, mute, adjust volume, hang up
- Available on smartphones and tablets (iOS and Android)

*View shared content on a mobile device:*

- View shared content, review previous slides, save selected slides
- Available on smartphones and tablets (iOS and Android)
- For DX70 and DX80, this service is available only when in a call

*Wireless share from a desktop client:*

- Share content without connecting a presentation cable
- Available on laptops (OS X and Windows)

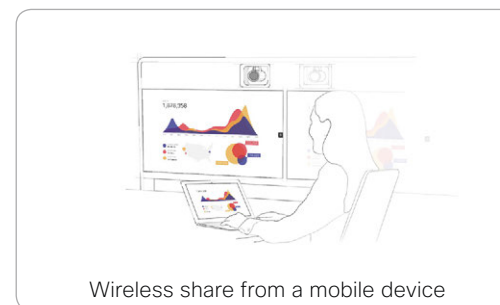
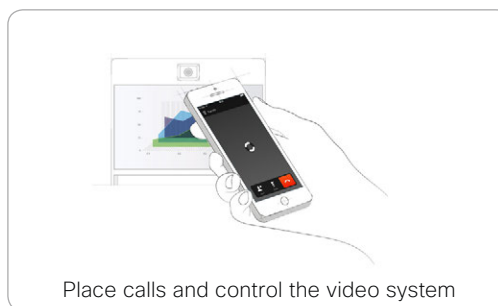

## Set up Intelligent Proximity for content sharing (page 2 of 5)

### Install a Cisco Proximity client

#### Where to find the clients

You can download the Cisco Proximity clients for smartphones and tablets (Android and iOS), and laptops (Windows and OS X) free of charge from ► <https://proximity.cisco.com>

Clients for smartphones and tablets are also available directly through Google Play (Android) and Apple App Store (iOS).

#### End-user license agreement

Read the end-user license agreement carefully, ► [https://www.cisco.com/c/en/us/td/docs/general/warranty/English/EU1KEN\\_.html](https://www.cisco.com/c/en/us/td/docs/general/warranty/English/EU1KEN_.html)

#### Supported operating systems

- iOS 7 and above
  - Android 4.0 and above
  - Mac OS X 10.9 and above
  - Windows 7 and above
- The tile based interface introduced with Windows 8 is not supported.

## Set up Intelligent Proximity for content sharing (page 3 of 5)

### Ultrasound emission

Cisco video systems emit ultrasound as part of the Proximity feature.

Use the [Proximity > Mode](#) setting to switch the Proximity feature – and thereby also ultrasound emission – **On** and **Off**.

Most people are exposed to ultrasound more or less daily in many environments, including industry, commercial applications and home appliances.

Even if airborne ultrasound may cause subjective effects for some individuals, it is very unlikely that any effects will occur for levels below 75 dB.

*Room 70, Room 70 G2, Room 55, Room 55 Dual, Room Kit, Room Kit Plus, SX10N and MX Series:*

- The ultrasound sound pressure level is below 75 dB at a distance of 50 cm or more from the loudspeaker.

*DX70 and DX80:*

- The ultrasound sound pressure level is below 75 dB at a distance of 20 cm or more from the loudspeaker.

*Codec Plus, Codec Pro, SX10, SX20, and SX80:*

- We cannot foresee the ultrasound sound pressure level on these video systems, because they emit ultrasound on third-party loudspeakers.

The volume control on the loudspeaker itself, and the [Audio > Ultrasound > MaxVolume](#) setting affect the ultrasound sound pressure level; the volume control on the remote control or Touch controller does not have any effect.

### Headsets

*DX70, DX80, and SX10N:*

You can always use a headset with these systems because:

- DX70 and DX80 have dedicated headset outputs, on which we never emit ultrasound.
- SX10N plays ultrasound on the built-in loudspeakers. Ultrasound is never emitted on the HDMI or audio outputs.

*Room 70, Room 70 G2, Room 55, Room 55 Dual, Room Kit, Room Kit Plus, Codec Plus, Codec Pro, SX10, SX20, SX80, and MX Series:*

- These systems are not designed for headset use.
- We strongly recommend you to switch off ultrasound emission if you use a headset with these video systems (set [Proximity > Mode](#) to **Off**). Then you *cannot* use the Proximity feature.
- Since these systems don't have dedicated headset outputs, we are not able to control the sound pressure level from the connected headsets.

## Set up Intelligent Proximity for content sharing (page 4 of 5)

### Enable Proximity services

1. Sign in to the web interface, and navigate to [Setup > Configuration](#).
2. Go to [Proximity > Mode](#), and switch Proximity **On**.

The video system starts sending ultrasound pairing messages. Enable the services you want to allow. Only *Wireless share from a desktop client* is enabled by default.

In order to fully utilise the Proximity functionality, we recommend that you enable all services.

*Place calls and control the video system:*

- Go to [Proximity > Services > CallControl](#) and choose **Enabled**.

*View shared content on a mobile device:*

- Go to [Proximity > Services > ContentShare > ToClients](#) and choose **Enabled**.

*Wireless share from a desktop client:*

- Go to [Proximity > Services > ContentShare > FromClients](#) and choose **Enabled**.

### The Proximity indicator



You can see the Proximity indicator on the screen as long as at least one Proximity client is paired with the system.

The indicator doesn't disappear immediately when the last client unpairs. It may take a few minutes.

### About Proximity

The Proximity feature is switched **Off** by default, because the use of third-party speakers may need additional testing for Proximity to work as expected. In rare cases the ultrasound may cause audio artifacts. If so, consider to decrease the maximum ultrasound volume with the [Audio > Ultrasound > MaxVolume](#) setting.

When Proximity is switched **On**, the video system transmits ultrasound pairing messages.

The ultrasound pairing messages are received by nearby devices with Proximity clients, and triggers the authentication and authorization of the device.

Provided that you have verified that Proximity is suitable in your setup, Cisco recommends – for the best user experience – that Proximity always is switched **On**\*

In order to get full access to Proximity, the Proximity services ([Proximity > Services > ...](#)) must be **Enabled** as well.

---

\* We recommend *not* to use a headset, if you have switched **on** Proximity (ultrasound).



## Set up Intelligent Proximity for content sharing (page 5 of 5)

### Room considerations

#### Room acoustics

- Rooms with hard surfaces may cause challenges due to severe audio reflections. Acoustical treatment of meeting rooms is always highly recommended for the best meeting experience as well as Intelligent Proximity performance.
- Cisco recommends only one video system with Intelligent Proximity enabled in a room. Otherwise, interference is likely to occur, which may lead to problems with device discovery and session maintenance.

### About privacy

In the Cisco Privacy statement and the Cisco Proximity Supplement you find information about data collection in the clients and privacy concerns that needs to be considered when deploying this feature in the organization. Refer to:

► <https://www.cisco.com/web/siteassets/legal/privacy.html>

### Basic troubleshooting

#### Cannot detect devices with Proximity clients

- Check if the video system is in standby mode. Ultrasound is not transmitted if the speakers (for example a TV in standby mode) are turned off. Check the speaker volume. The volume control on a speaker itself (not the volume controlled with the remote control or Touch 10) affects the ultrasound volume. If the volume is too low, the listening devices cannot detect the ultrasound pairing messages. Some Windows laptops are not able to record sound in the ultrasound frequency range (20kHz-22kHz). This can be due to frequency limitations with the sound card, sound driver or the internal microphone of the particular device. Refer to the Support forum for more information.
- Check *Settings > Issues and diagnostics* on the user interface, or *Maintenance > Diagnostics* on the web interface of the video system. If there are no ultrasound related Issues listed ("Unable to verify the ultrasound signal"), ultrasound pairing messages are emitted by the video system as they should. Refer to the Proximity *Support forum* for further assistance with the client detection issues.

#### Audio artifacts

- If you can hear audio artifacts, like humming or clipping noise, decrease the maximum ultrasound volume (*Audio > Ultrasound > MaxVolume*).

#### Cannot share content from a laptop

- For content sharing to work, the video system and the laptop must be on the same network. For this reason Proximity sharing might fail if your video system is connected to your company network via Expressway, and your laptop is connected via VPN (VPN client dependent).

### Additional resources

Cisco Intelligent Proximity site:

► <https://www.cisco.com/go/proximity>

Support forum:

► <https://www.cisco.com/go/proximity-support>

## Adjust the video quality to call rate ratio (page 1 of 2)

### Video input quality settings

When encoding and transmitting video there is a trade-off between high resolution (sharpness) and high frame rate (motion).

The *Video Input Connector n Quality* setting must be set to **Motion** for the optimal definition settings to take any effect. With the video input quality set to **Sharpness**, the endpoint will transmit the highest resolution possible, regardless of frame rate.

### Optimal definition profile

The optimal definition profile should reflect the lighting conditions in the video conferencing room and the quality of the camera (video input source). The better the lighting conditions and the better the quality of the camera, the higher the profile should be used.

Generally, the Medium profile is recommended. However, if the lighting conditions are very good, we recommend that you test the endpoint on the various Optimal Definition Profile settings before deciding on a profile. The High profile may be set in order to increase the resolution for a given call rate.

Some typical resolutions used for different optimal definition profiles, call rates and transmit frame rates are shown in the tables on the next page. The resolution and frame rate must be supported by both the calling and called systems.

Sign in to the web interface and navigate to [Setup > Configuration](#).

1. Go to [Video > Input > Connector n > Quality](#) and set the video quality parameter to **Motion**.
2. Go to [Video > Input > Connector n > OptimalDefinition > Profile](#) and choose the preferred optimal definition profile.

## Adjust the video quality to call rate ratio (page 2 of 2)

Resolutions and frame rate [w×h@fps] obtained for different optimal definition profiles and call rates						
Call rate [kbps]	H.264, maximum 30 fps			H.264, maximum 60 fps		
	<i>Normal</i>	<i>Medium</i>	<i>High</i>	<i>Normal</i>	<i>Medium</i>	<i>High</i>
128	320×180@30	320×180@30	512×288@30	320×180@30	512×288@20	512×288@30
256	512×288@30	640×360@30	768×448@30	512×288@30	640×360@30	768×448@30
384	640×360@30	768×448@30	768×448@30	640×360@30	768×448@30	768×448@30
576	768×448@30	1024×576@30	1280×720@30	768×448@30	1024×576@30	1280×720@30
768	1024×576@30	1280×720@30	1280×720@30	1024×576@30	1280×720@30	1280×720@30
1152	1280×720@30	1280×720@30	1280×720@30	1280×720@30	1280×720@30	1280×720@60
1472	1280×720@30	1280×720@30	1920×1080@30	1280×720@30	1280×720@30	1280×720@60
1536	1280×720@30	1280×720@30	1920×1080@30	1280×720@30	1280×720@60	1280×720@60
2176	1280×720@30	1920×1080@30	1920×1080@30	1280×720@60	1280×720@60	1280×720@60
3232	1920×1080@30	1920×1080@30	1920×1080@30	1280×720@60	1920×1080@60	1920×1080@60
4736	1920×1080@30	1920×1080@30	1920×1080@30	1920×1080@60	1920×1080@60	1920×1080@60
6000	1920×1080@30	1920×1080@30	1920×1080@30	1920×1080@60	1920×1080@60	1920×1080@60

Resolutions and frame rate [w×h@fps] obtained for different optimal definition profiles and call rates						
Call rate [kbps]	H.265, maximum 30 fps			H.265, maximum 60 fps		
	<i>Normal</i>	<i>Medium</i>	<i>High</i>	<i>Normal</i>	<i>Medium</i>	<i>High</i>
128	512×288@30	512×288@30	640×360@30	512×288@30	512×288@30	640×360@30
256	640×360@30	768×448@30	768×448@30	640×360@30	768×448@30	768×448@30
384	768×448@30	1024×576@30	1280×720@30	768×448@30	1024×576@30	1280×720@30
576	1024×576@30	1280×720@30	1280×720@30	1024×576@30	1280×720@30	1280×720@30
768	1280×720@30	1280×720@30	1920×1080@30	1280×720@30	1280×720@30	1280×720@60
1152	1280×720@30	1920×1080@30	1920×1080@30	1280×720@30	1280×720@60	1280×720@60
1472	1280×720@30	1920×1080@30	1920×1080@30	1280×720@60	1280×720@60	1280×720@60
1536	1920×1080@30	1920×1080@30	1920×1080@30	1280×720@60	1280×720@60	1920×1080@60
2176	1920×1080@30	1920×1080@30	1920×1080@30	1280×720@60	1920×1080@60	1920×1080@60
3232	1920×1080@30	1920×1080@30	1920×1080@30	1920×1080@60	1920×1080@60	1920×1080@60
4736	1920×1080@30	1920×1080@30	1920×1080@30	1920×1080@60	1920×1080@60	1920×1080@60
6000	1920×1080@30	1920×1080@30	1920×1080@30	1920×1080@60	1920×1080@60	1920×1080@60

## Add corporate branding to the screen and Touch 10 user interface (page 1 of 2)

Sign in to the web interface, and navigate to [Setup > Personalization](#), and open the [Branding](#) tab.

From this page you can add your own branding elements (background brand image, logo, custom message) to the video system.

### Branding in the awake state

In the awake state you can:

- Add a logo in the bottom right corner (screen and Touch 10)
- Add a short message (text only) in the bottom left corner (only on screen, not on Touch 10)

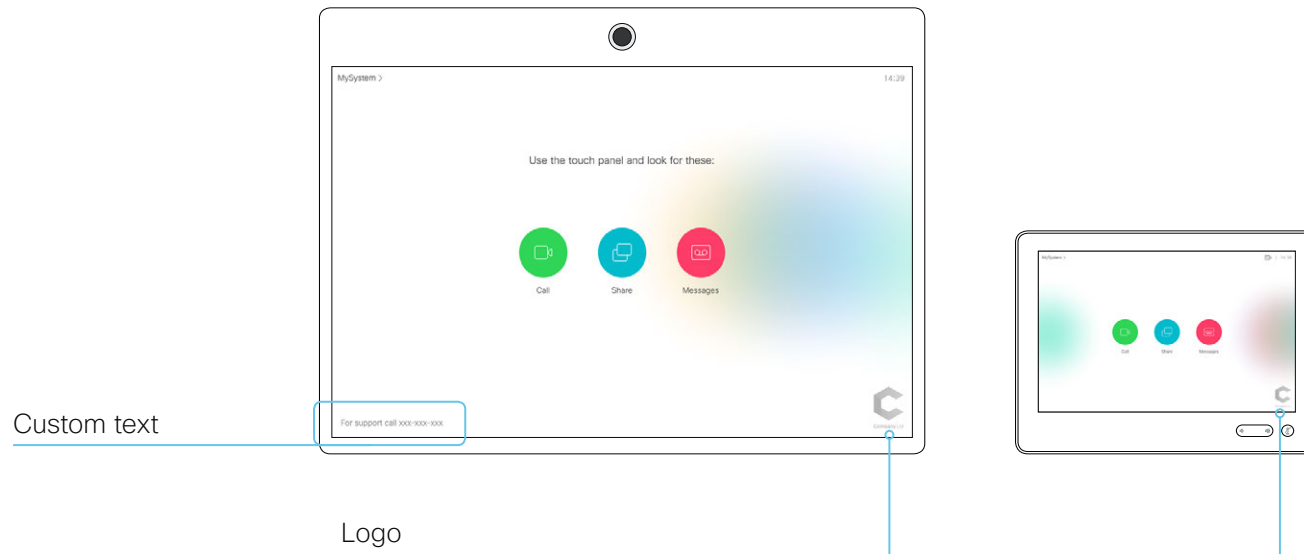

#### Logo

We recommend:

- A black logo (the video system will add a white overlay with 40% opacity so that the logo and the other user interface elements go well together)
- PNG-format with transparent background
- Minimum 272x272 pixels (it will be scaled automatically)

### About Branding

The Branding feature, as describe in this chapter, allows you to customize the screen and Touch user interface appearance without compromising the overall Cisco user experience.

We recommend that you use this feature rather than our legacy Custom wallpaper feature, which prevents the use of functionality such as One Button to Push.

**You cannot use the Branding feature and a Custom wallpaper at the same time.**

If your video system is set up with a Custom wallpaper, you must click [Disable the custom wallpaper](#) before adding branding elements.

## Add corporate branding to the screen and Touch 10 user interface (page 2 of 2)

### Branding in the halfwake state

In halfwake state you can:

- Add a background brand image (screen and Touch 10)
- Add a logo in the bottom right corner (screen and Touch 10)
- Customize or remove the message at the center of the screen (only on screen, not on Touch 10). This is the message that informs the user how to start using the video system

In general, we recommend that you keep the standard message. Change the message only if you have to adapt it to a different scenario, for example if you have a third party user interface.

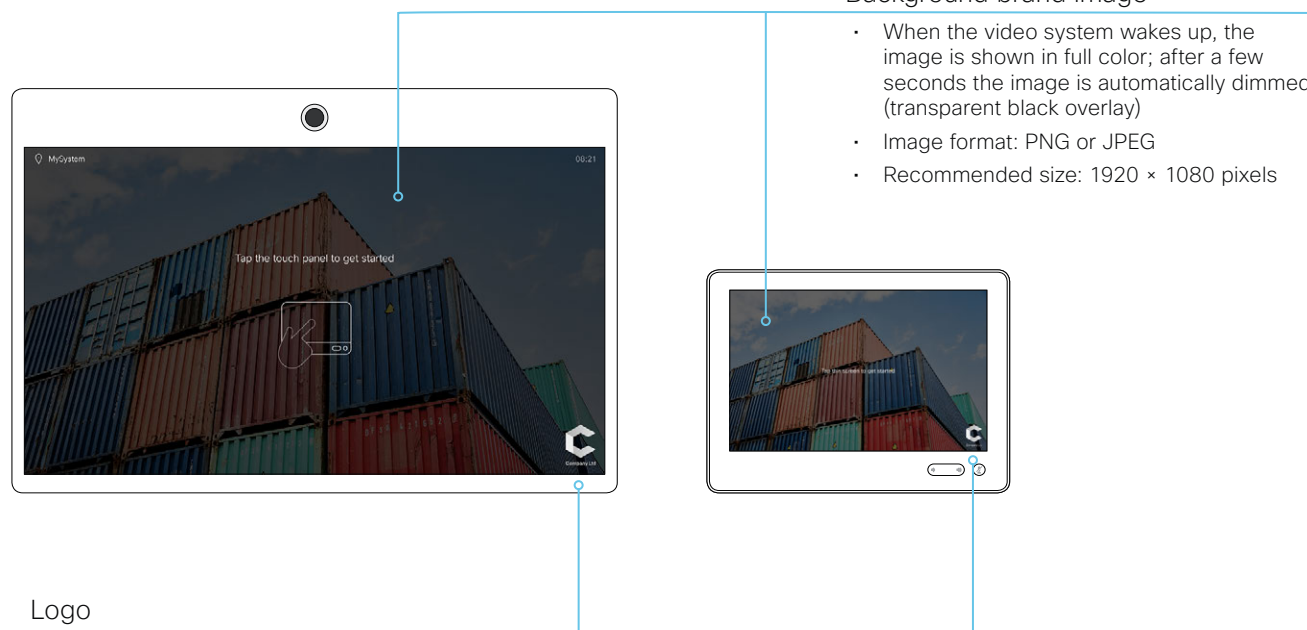

#### Background brand image

- When the video system wakes up, the image is shown in full color; after a few seconds the image is automatically dimmed (transparent black overlay)
- Image format: PNG or JPEG
- Recommended size: 1920 × 1080 pixels

#### Logo

We recommend:

- A white logo (so that it goes well with the dark background brand image)
- PNG-format with transparent background
- Minimum 272×272 pixels

## Add a custom wallpaper

Sign in to the web interface, and navigate to [Setup > Personalization](#), and open the [Custom wallpaper](#) tab.

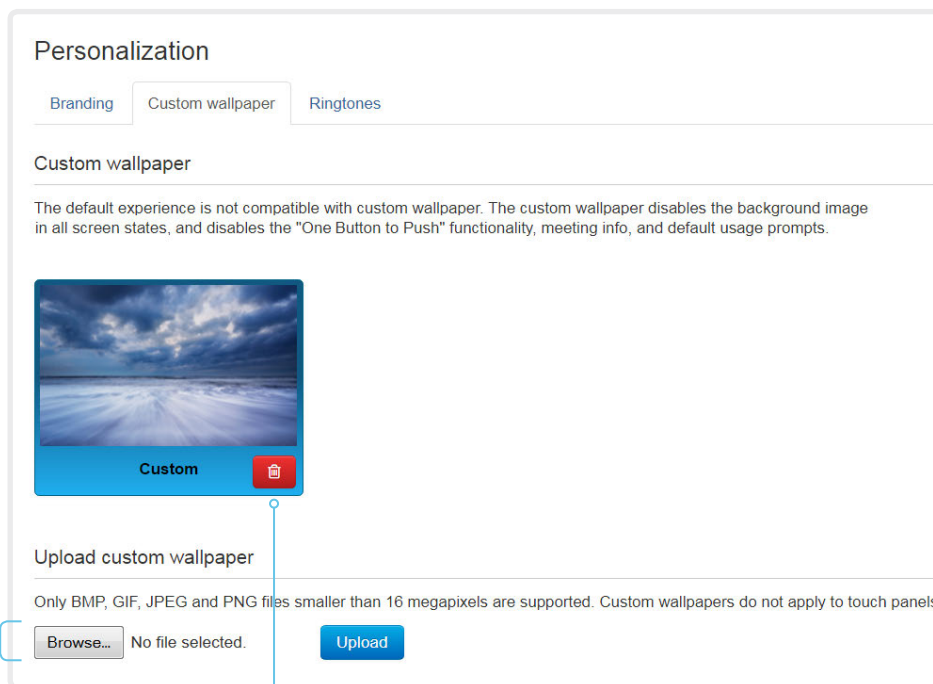

### Upload a custom wallpaper

Overwrites any old custom wallpaper.

1. Browse to find the custom wallpaper image file.
2. Click [Upload](#) to save the file on the video system.

Supported file formats: BMP, GIF, JPEG, PNG

Maximum file size: 16 megapixels

The custom wallpaper is automatically activated once uploaded.

### Delete the custom wallpaper

[Delete](#) fully removes the custom wallpaper from the video system.

You have to upload it anew if you want use it again.

### About a custom wallpaper

If you want a custom picture as background on your screen, you may upload and use a *custom wallpaper*. A custom wallpaper will not appear on the Touch controller.

You can only store one custom wallpaper on the video system at a time; a new custom wallpaper overwrites the old one.

We recommend that you use our new Branding feature rather than this legacy Custom wallpaper feature. You will get a better overall Cisco user experience, and avoid losing functionality such as One Button To Push and meeting information. See the [Add corporate branding to the screen and Touch 10 user interface](#) chapter.

**You cannot use the Branding feature and a Custom wallpaper at the same time.**

If your video system is set up with branding elements you must click [Continue without branding](#) before adding a custom wallpaper.

## Choose a ringtone and set the ringtone volume

Sign in to the web interface, and navigate to [Setup > Personalization](#), and open the [Ringtones](#) tab.

### Change the ringtone

1. Choose a ringtone from the drop-down list.
2. Click [Save](#) to make it the active ringtone.

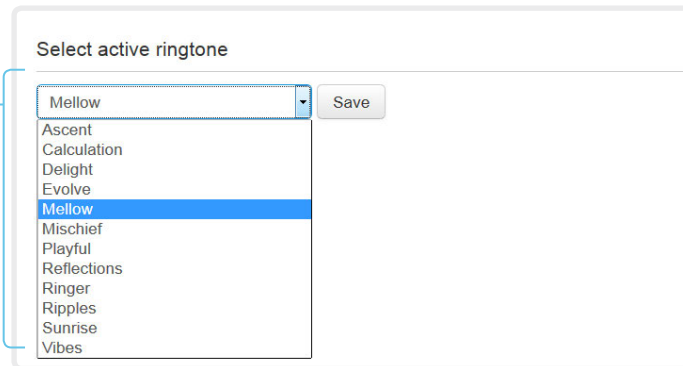

### Set the ringtone volume

Use the slide bar to adjust the ringtone volume.

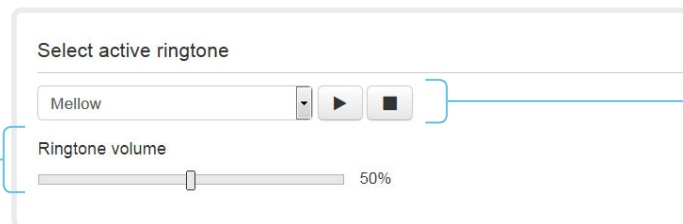

### Play back the ringtone

Click the play button (▶) to play back the ringtone.

Use the stop button (■) to end the playback.

### About ringtones

A set of ringtones are installed on the video system. Use the web interface to choose a ringtone, and set the ringtone volume.

You can play back the chosen ringtone from the web interface. Note that the ringtone will be played back on the video system itself, and not on the computer running the web interface.

## Manage the Favorites list

Sign in to the web interface and navigate to [Setup > Favorites](#).

### Import/Export contacts from file

Click [Export](#) to save the local contacts in a file; and click [Import](#) to bring in contacts from a file.

The current local contacts are discarded when you import new contacts from a file.

### Add or edit a contact

1. Click [Add contact](#) to make a new local contact, or click a contact's name followed by [Edit contact](#).

2. Fill in or update the form that pops up.

Choose a folder in the folder drop down list in order to store the contact in a sub-folder.

Click [Add contact method](#) and fill in the new input fields if you want to store more than one contact method for the contact (for example video address, telephone and mobile number).

3. Click [Save](#) to store the local contact.

### Delete a contact

1. Click a contacts name followed by [Edit contact](#).
2. Click [Delete](#) to remove the local contact.

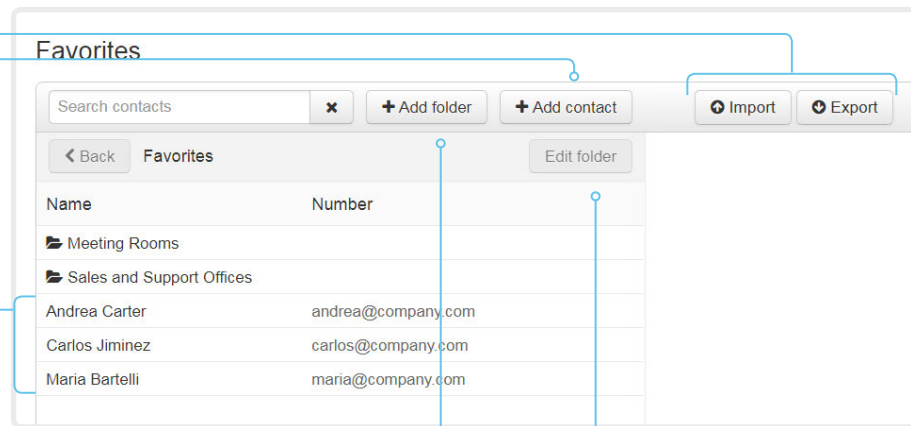

### Add or edit a sub-folder

1. Click [Add folder](#) to make a new sub-folder, or click one of the listed sub-folders followed by [Edit folder](#) to change an existing sub-folder.
2. Fill in or update the form that pops up.
3. Click [Save](#) to create or update the folder.

### Delete a sub-folder

1. Click a folder's name followed by [Edit folder](#).
2. Click [Delete](#) to remove the folder and all its contacts and sub-folders. Confirm your choice in the dialog that pops up.

## Manage Favorites using the video system's user interface

### Add a contact in the Favorites list

1. Select [Call](#) on the home screen.
2. Select the contact you want to add.
3. Select [Add to favorites](#).

The contact you add will be placed in the top folder. You cannot select or create a sub-folder.

### Remove a contact from the Favorites list

1. Select [Call](#) on the home screen.
2. Select the [Favorites](#) tab.
3. Select the contact you want to remove.
4. Select [Remove favorite](#).



## Set up accessibility features

### Flashing screen for incoming calls

To make it easier for the hearing impaired users to notice when someone is calling, the screen can be setup to flash red and gray on incoming calls.

1. Sign in to the web interface, and navigate to [Setup > Configuration](#).
2. Go to [UserInterface > Accessibility > IncomingCallNotification](#) and select **AmplifiedVisuals**.
3. Click [Save](#).

## Chapter 3

# Peripherals

## Connect monitors (page 1 of 2)

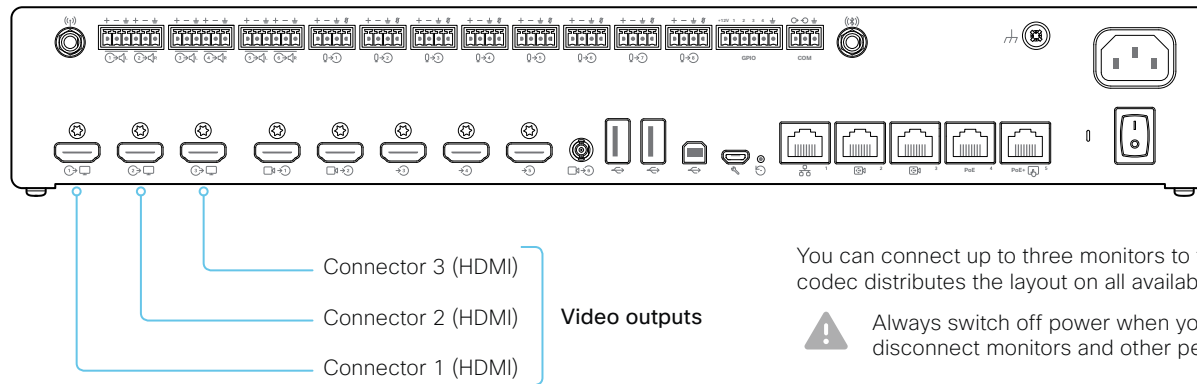

You can connect up to three monitors to the codec. The codec distributes the layout on all available monitors.



Always switch off power when you connect and disconnect monitors and other peripherals.

### Automatic setup

There is no special configuration needed on the video system in order to support dual monitors or triple monitors scenarios. By default the number of monitors are auto-detected, and the role of each monitor - whether it is intended to be the first, or second, or third monitor - is automatically set according to the physical connections.

For example, if the total number of monitors are three, the following settings will be assumed when set to **Auto**:

- [Video > Monitors](#): **Triple**
- [Video > Output > Connector 1 > MonitorRole](#): **First**
- [Video > Output > Connector 2 > MonitorRole](#): **Second**
- [Video > Output > Connector 3 > MonitorRole](#): **Third**

### When do you need manual setup

You can override the default behavior by setting one or more settings manually. You need manual setup when you want to:

- Dedicate a monitor to only show presentations
- Use one of the outputs for a recorder
- Replicate the same layout on more than one monitor
- Show the on-screen messages and indicators (OSD) on another monitor than the video output with the lowest number
- Set the resolution manually, e.g. if the video system fails to detect the native resolution and refresh rate of a monitor

### About video outputs

Codec Pro has three HDMI outputs. These outputs can be used simultaneously.

Typically, the outputs are used for monitors or other displays. You can also connect a recorder.

The HDMI outputs support resolutions up to 3840 × 2160 at 60 fps. You need Premium HDMI cables to support the high resolutions and frame rates.

If the connected camera has loudspeakers (Quad Camera) there is no audio on the HDMI outputs. If all connectors are set to Auto and no Quad Camera is connected, the system will try HDMI 1, then HDMI 2, and finally HDMI 3 and play the audio on the first available screen. See full description of the Audio Output HDMI [n] Mode in the System Settings section.

## Connect monitors (page 2 of 2)

### Manual setup

The automatic setup works well for common single monitor, dual monitors, and triple monitors scenarios. For more complex scenarios, you may need manual configuration.

Sign in to the web interface and navigate to [Setup > Configuration](#), to find the settings referred below.

#### Set a role for each monitor

Define a role for each monitor with the [Video > Output > Connector n > MonitorRole](#) setting.

Choose monitor roles that match your monitor setup.

#### Set the number of monitors

Set the number of monitors with different layouts in your setup with the [Video > Monitors](#) setting.

When set to **Auto**, the video system automatically detects if a monitor is connected to a connector, and thereby also determines the number of monitors in the setup.

The other options allow you to fix a single dual monitor setup; and to dedicate one monitor for presentations.

#### Choose on which monitor to display messages and indicators

Define on which monitor to display the messages and indicators on-screen with the [UserInterface > OSD > Output](#) setting.

When set to **Auto**, the video system determines which monitor to use based on the number of the connector.

#### Set the monitor resolution and refresh rate

The video system reads the native resolution of a monitor and outputs this if possible. Typically, this gives the best possible picture for the monitor.

If auto-detection of resolution and refresh rate fails, you must set the resolution manually with the [Video > Output > Connector n > Resolution](#) setting.

### About the number of monitors and the role of each monitor

The [Video > Output > Connector n > MonitorRole](#) setting assigns a role to the monitor that is connected to the output. The monitor role decide which layout (call participants and presentation) will appear on the monitor.

Monitors with the same monitor role get the same layout; monitors with different monitor roles get different layouts.

The [Video > Monitors](#) setting must reflect *the number of different layouts* in your room setup.

Most often the number of different layouts are the same as the number of physical monitors, but not always. If exactly the same layout shall be repeated on two or more monitors, the number of different layouts is less. Note that a monitor can be reserved for presentations.

#### Example:

Three monitors in total, and the third monitor is dedicated to only show presentations:

- [Video > Monitors](#): **TriplePresentationOnly**
- [Video > Output > Connector 1 > MonitorRole](#): **Auto**
- [Video > Output > Connector 2 > MonitorRole](#): **Auto**
- [Video > Output > Connector 3 > MonitorRole](#): **Auto**
- [UserInterface > OSD > Output](#): **1**

#### Example 2:

Two monitors in total, and a recording device is attached to Connector 3 (HDMI). OSD is on the monitor on Connector 2:

- [Video > Monitors](#): **Auto**
- [Video > Output > Connector 1 > MonitorRole](#): **Auto**
- [Video > Output > Connector 2 > MonitorRole](#): **Auto**
- [Video > Output > Connector 3 > MonitorRole](#): **Recorder**
- [UserInterface > OSD > Output](#): **2**

## Connect input sources (page 1 of 2)

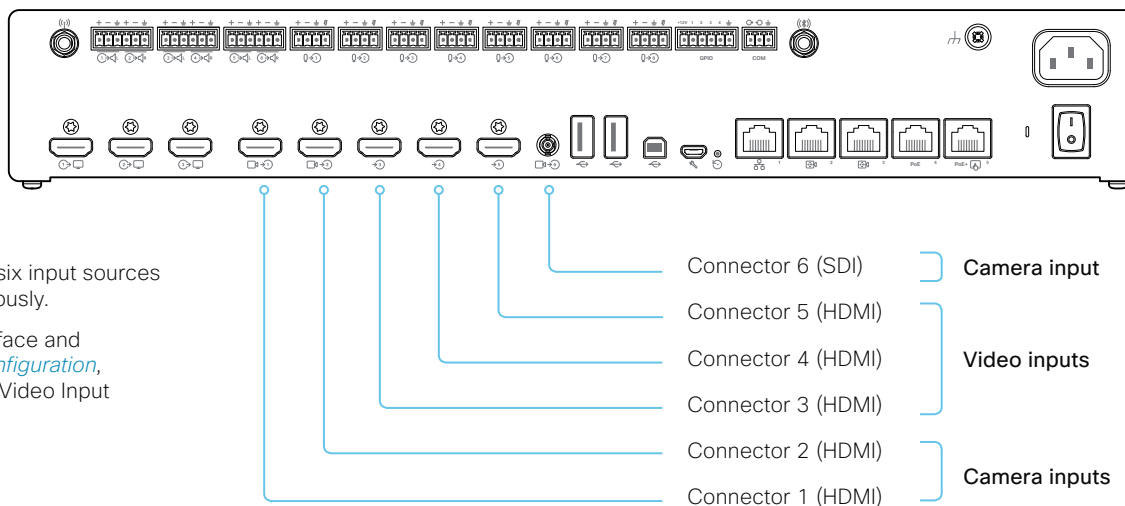

You can connect up to six input sources to the codec simultaneously.

Sign in to the web interface and navigate to [Setup > Configuration](#), for configuration of the Video Input Connector settings.

### About the video inputs

The system has six video inputs, where five are HDMI inputs and one SDI input. Typically, the inputs are used for cameras and computers. You can also connect other types of video and content sources.

### Connect a camera

The codec supports maximum three cameras. The cameras are connected to the HDMI inputs (Connector 1-2), or to the 3G-SDI/HD-SDI (Connector 6).

Always use Connector 1 (HDMI) for the main camera. If you have a SpeakerTrack 60 camera assembly, connect its two cameras to Connector 1 (HDMI) and Connector 2 (HDMI).

See the Codec Pro Installation Guide, or the camera's documentation, about how to connect the cables for the different cameras.

### Connect a computer

Connect a computer to a video input in order to share content locally or with conference participants. The codec supports two computers simultaneously.

Typically, computers are connected to Connector 3-5 (HDMI).

## Connect input sources (page 2 of 2)

### Set type and name for an input source

We recommend that you set type and name for an input source:

- [Video > Input > Connector n > InputSourceType](#)
- [Video > Input > Connector n > Name](#)

These settings determine the names and icons that are shown on the user interfaces. Intuitive names and icons make source selection easier.

### About video and content quality

Use the [Video > Input > Connector n > Quality](#) setting to optimize quality with respect to motion or sharpness.

Typically, you should choose **Motion** when a large number of participants are present or when there is a lot of motion in the picture. Choose **Sharpness** when you want the highest quality of detailed images and graphics.

The default value is **Motion** for Connector

The default value is **Motion** for Connector 1, 2 and 6; and **Sharpness** for Connector 3, 4 and 5

## Extend the number of input sources

You can customize our touch user interfaces to include input sources that are connected to a third-party external video switch.

The sources will appear and behave as any other video source that is connected directly to the video system.

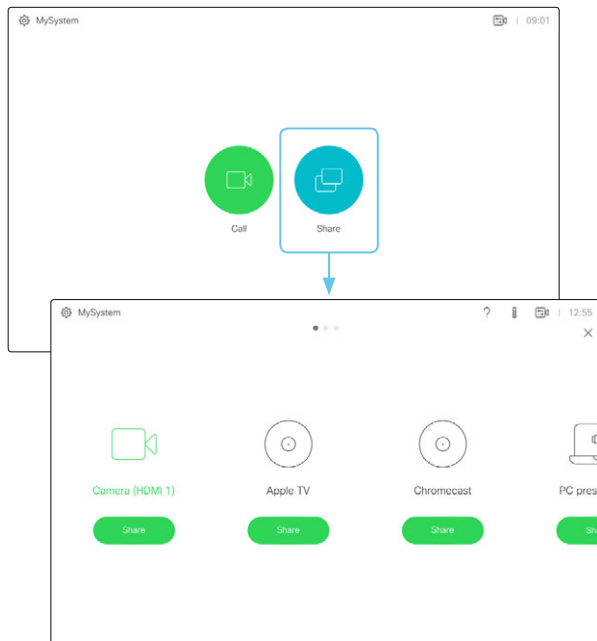

User interface with multiple external input sources (example)

Consult the *CE Customization guide* for full details about how to extend the user interface, and how to use the video system's API to set it up. Go to:

► <https://www.cisco.com/go/in-room-control-docs>

## Architecture

You need a Cisco video system with a touch interface, a third-party control system, for example Crestron or AMX, and a third-party video switch. It is the control system, not the video system, that controls the video switch.

When you program the control system you must use the video system's API (events and commands)\* in order to connect with the video switch and the controls on the touch interface. This way you can synchronize what is shown and done on the user interface with the actual state of the input sources.

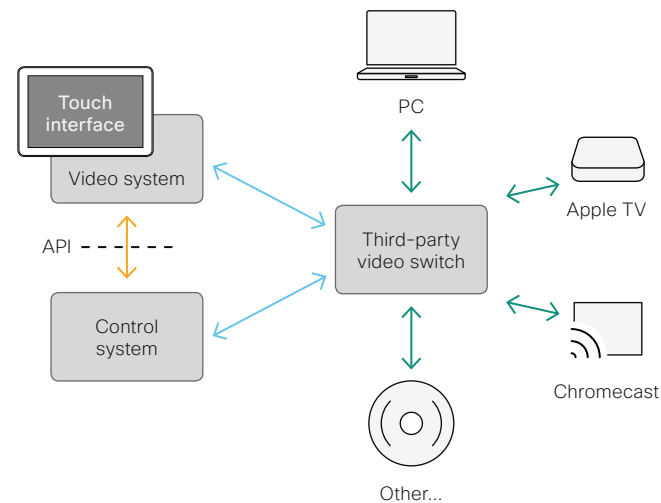

\* You need a user that holds the ROOMCONTROL, INTEGRATOR, or ADMIN user roles in order to access the API commands that you need when programming the control system.

## Information about displays

### Real-time communication requirements

We have put in a lot of effort to minimize the camera to screen delay on our video systems, and also to detect and compensate for total delay between the audio and video components.

We recommend that you use displays with low delay to increase the naturalness of communications. We also recommend that you test a sample before ordering a large number of displays.

Delay through most displays is often very high (>100 ms) and is therefore detrimental to real-time communication quality.

The following display settings may reduce the delay:

- Activate *Game* mode, *PC* mode or similar modes that are designed to reduce the response time and normally also the delay
- Deactivate motion smoothing, like *Motion Flow*, *Natural Motion*, or any other video processing that introduces additional delay
- Deactivate advanced audio processing, like *Virtual Surround* effects and *Dynamic Compression*, which will make any acoustic echo canceller malfunction
- Change to a different HDMI input

### Consumer Electronics Control (CEC)

The active video input on a display is sometimes changed by a user. The video input that is active is set from the manufacturer's user interface.

When you make a call the video system detects if the active video input on the display has been switched to another input. The video system then switches the input back so the video system is the active video input source.

If the video system goes into standby without being the active input source, the display will not be set to standby.

### Cisco recommended displays

Cisco recommends using the following displays for the best experience and verified compatibility. The list of displays is subject to change, check the CE9 Software Release Notes for updates.

Model	LG global website link
49" UHD (49UH5C)	<a href="http://www.lg.com/global/business/information-display/digital-signage/lg-49UH5C">http://www.lg.com/global/business/information-display/digital-signage/lg-49UH5C</a>
55" UHD (55UH5C)	<a href="http://www.lg.com/global/business/information-display/digital-signage/lg-55UH5C">http://www.lg.com/global/business/information-display/digital-signage/lg-55UH5C</a>
65" UHD (65UH5C)	<a href="http://www.lg.com/global/business/information-display/digital-signage/lg-65UH5C">http://www.lg.com/global/business/information-display/digital-signage/lg-65UH5C</a>
75" UHD (75UH5C)	<a href="http://www.lg.com/global/business/information-display/digital-signage/lg-75UH5C">http://www.lg.com/global/business/information-display/digital-signage/lg-75UH5C</a>
86" UHD (86UH5C)	<a href="http://www.lg.com/global/business/information-display/digital-signage/lg-86UH5C">http://www.lg.com/global/business/information-display/digital-signage/lg-86UH5C</a>
98" UHD (98UH5C)	<a href="http://www.lg.com/global/business/information-display/digital-signage/lg-98LS95D">http://www.lg.com/global/business/information-display/digital-signage/lg-98LS95D</a>

Model	Samsung global website link
QMN Series (43", 49", 55", 65", 75")	<a href="https://displaysolutions.samsung.com/digital-signage/detail/1269/QM43N">https://displaysolutions.samsung.com/digital-signage/detail/1269/QM43N</a>
QMH Series (49", 55", 65")	<a href="https://displaysolutions.samsung.com/digital-signage/detail/1144/QM49H">https://displaysolutions.samsung.com/digital-signage/detail/1144/QM49H</a>
QBN Series (43", 49", 55", 65", 75")	<a href="https://displaysolutions.samsung.com/digital-signage/detail/1274/QB43N">https://displaysolutions.samsung.com/digital-signage/detail/1274/QB43N</a>
QBH Series (65" , 75")	<a href="https://displaysolutions.samsung.com/digital-signage/detail/1205/QB65H">https://displaysolutions.samsung.com/digital-signage/detail/1205/QB65H</a>



## Information about 4K resolution

### Connecting a display

When you start the system for the first time, the setup assistant starts automatically. This is where you test the display and adjust the settings. Follow the on-screen instructions.

If you need to adjust the settings at a later stage, sign in to the web interface, and navigate to [Setup > Configuration > Video > Output > Connector n > Resolution](#) and adjust the screen resolution. Set the resolution according to what your display supports.

If your screen is black or flickering, you can set the resolution to a lower setting. If there still are problems, check that the HDMI cable is connected to an HDMI port on your display that supports Ultra HD. Check also that the HDMI Ultra HD settings are set to On on your display.

Cisco provides a list of displays that we have tested. Refer to the [Cisco recommended displays](#) chapter.

### Connecting a computer

If an error occurs when you connect a computer, a message will show on screen and on the Touch 10 controller.

The default preferred resolution on the video input connector is 1080p60 (1920\_1080\_60). If you want to use 4K resolution with the computer, sign in to the web interface, and navigate to [Setup > Configuration > Video > Input > Connector n > PreferredResolution](#) and adjust the value.

Alternatively, you can override the resolution from the display/monitor configuration offered by the operating system of the connected computer.

### Checklist

For guaranteed operation, order HDMI cables from Cisco, or use certified HDMI cables. Refer to the [Information about HDMI cables](#) chapter.

Check that the video systems input/output connector(s) are configured correctly.

Check that the device (TV/display, computer) has support for 4K and that it is configured correctly.

The manufacturer may advertise that a TV/display supports 4K, but you should test the TV/display to make sure it works.

The need for high quality cables increases with 4K usage:

- 4kp30 uses about twice the data rate of 1080p60
- 4kp60 uses about four times the data rate of 1080p60

## Information about HDMI cables

HDMI cables are required for cameras, displays and presentation sources.

 For guaranteed operation we recommend that you order HDMI cables from Cisco\*, or use certified HDMI cables.

### HDMI cables for cameras and displays

The resolution formats larger than 1920×1200@60fps require use of high speed HDMI cables. For guaranteed operation, use HDMI cables that are pre-qualified from Cisco for use at 3840×2160@60fps, or use a cable that has passed the Premium HDMI Cable Certification Programme.

### HDMI cables for presentation sources

A presentation source can be a PC/laptop, document camera, media player, whiteboard, or other device.

The resolution formats larger than 1920×1080@60fps require use of high speed HDMI cables. For guaranteed operation, use a HDMI cable from Cisco, or use a cable that complies with the high speed HDMI 1.4b Category 2 specification.

We recommend that you order the HDMI presentation cable from Cisco (HDMI 1.4b Category 2).

You can find more information about HDMI cables at ► <http://www.hdmi.org>

---

\* The following products do not support Cisco's presentation cable for HDMI, Display Port, and Mini Display Port (CAB-HDMI-MULT-9M=): Room Kit, Room Kit Plus, Codec Plus, Room 55, and Room 70.

## Set up the SpeakerTrack feature

Sign in to the web interface and navigate to [Setup > Configuration](#), to find the settings referred.

The speaker track feature uses automatic camera framing to select the best view based on how many people are in the room.

When closeup is enabled and a person in the room speaks, the system will find the person and select the best camera framing. The closeup may not include all the persons in the room. If you want all the persons in the room to be in the picture at all times you can turn off the closeup functionality.

### Best overview

The camera uses digital face detection to automatically create the best view of a single person or a group of people in the conference room. If people are moving around in the room or additional participants enters the conference room, the feature will adopt to the changes and automatically adjust the view to include all persons in the picture. This feature works together with speaker tracking to provide the best possible conferencing experience.

## Configure speaker tracking

Use the [Cameras > SpeakerTrack](#) settings to configure speaker tracking.

### [Cameras > SpeakerTrack > Mode](#)

**Auto:** Speaker tracking is enabled in general. The system will detect people in the room and automatically select the best camera framing. Users can switch speaker track on or off instantly in the camera control panel on the Touch controller.

**Off:** Speaker tracking is switched off. The speaker track on/off button will disappear from the Touch controller. The closeup function will be disabled.

### [Cameras > SpeakerTrack > Closeup](#)

This setting only applies when the Cameras SpeakerTrack Mode is set to Auto

**Auto:** The system will zoom in on the person speaking.

**Off:** The system will keep all the persons in the room in the camera framing at all times.

## Tracking mode

The tracking mode defines how fast the camera view switch to a new speaker when the tracking algorithm detects a change.

Use the [Cameras > SpeakerTrack > TrackingMode](#) setting to select between the two modes.

**Auto:** This is the default setting.

**Conservative:** The system reacts slower to detected changes, and the camera view will switch to a new speaker later.

## Products that support speaker tracking

The following Cisco products support speaker tracking:

- MX700 and MX800 with dual camera
- SX80 with SpeakerTrack 60 camera or Quad camera
- Room Kit
- Room Kit Plus (Codec Plus and Quad Camera)
- Room Kit Pro (Codec Pro and Quad Camera)
- Room 55
- Room 55 Dual
- Room 70
- Room 70 G2

## Set up the Snap to Whiteboard feature (page 1 of 3)

The Snap to Whiteboard feature extends the speaker tracking functionality, thus you need a camera that supports SpeakerTrack:

- MX700 and MX800 with dual camera
- SX80 with SpeakerTrack 60 camera or Quad camera
- Room Kit
- Room Kit Plus (Codec Plus and Quad Camera)
- Room Kit Pro (Codec Pro and Quad Camera)
- Room 55
- Room 55 Dual
- Room 70
- Room 70 G2

With the Snap to Whiteboard extension, the camera captures both the person and the whiteboard when a person next to the whiteboard is speaking.

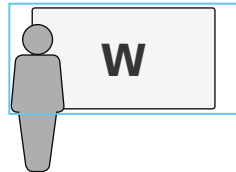

Without the Snap to Whiteboard extension, the camera captures only the person.

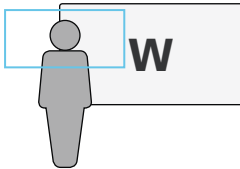

### Preparations

#### Whiteboard position

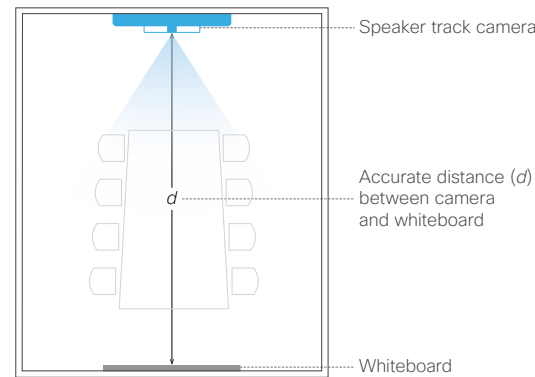

The whiteboard must be placed across the room from the camera, as shown in the illustration.

When configuring the feature, you need to know the accurate distance between the camera and the whiteboard.

#### Speaker position

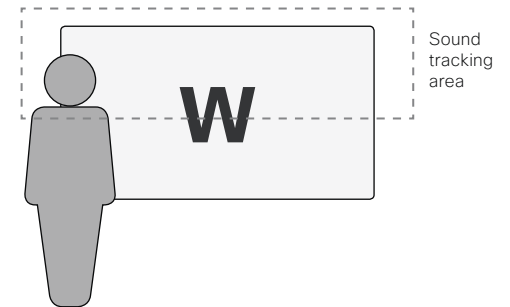

The *Sound tracking area* is from half the whiteboard and up.

Thus, the person presenting on the whiteboard must stand upright next to the whiteboard. He or she cannot move about in the room.

## Set up the Snap to Whiteboard feature (page 2 of 3)

The Snap to Whiteboard wizard is only available when:

- [Cameras](#) > [SpeakerTrack](#) > [Mode](#) is **Auto**.



### Define the whiteboard area

Use the wizard on the Touch controller to define the whiteboard area.

1. Tap the contact information in the upper left corner of the Touch controller and open the [Settings](#) menu.
2. Tap [Snap to Whiteboard](#).

Sign in with ADMIN credentials if the [Settings](#) menu is passphrase protected on your video system.

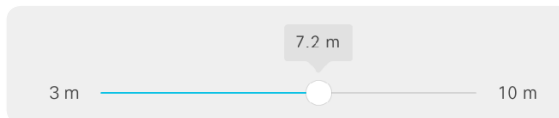

3. Tap [Configure](#) or [Reconfigure](#) to start the wizard (depends whether you configure the feature for the first time or not).

4. Follow the instructions in the wizard - use the back button  if you want to redo a step, and the next button  to move to the next step:
  - Move the slider to set the distance between the camera and the whiteboard. It is important that the distance is measured accurately.

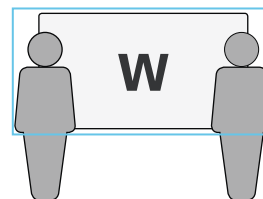

- Adjust the camera view (pan, tilt, zoom) to frame the whiteboard. Leave some space on both sides for the person that will be speaking.



- Stand next to the whiteboard and start speaking.  
If the camera zooms to the view that you have chosen for the whiteboard, the feature is correctly set up, and ready to use. If not, see the troubleshooting notes to the right.
- Tap  to close the wizard, and  to close the Settings panel.

### Troubleshooting

If the camera does not move to the whiteboard position when the person who is speaking stands next to the whiteboard, check the following and redo the required steps in the wizard:

- Check that the whiteboard is placed across the room from the camera.
- Check that the distance between the camera and whiteboard is measured accurately.
- The person who is speaking must be close to the whiteboard. Furthermore, the person must stand upright so that the sound comes from the upper half of the whiteboard area.

## Set up the Snap to Whiteboard feature (page 3 of 3)

### Enable and disable Snap to Whiteboard

You can enable or disable the Snap to Whiteboard feature from the *Settings* menu on the Touch controller or from the web interface.

**i** If the Settings menu on the Touch controller is open (not protected by the ADMIN passphrase), any user can switch the feature On and Off during a meeting or between meetings. Moreover, any user can reconfigure the feature.

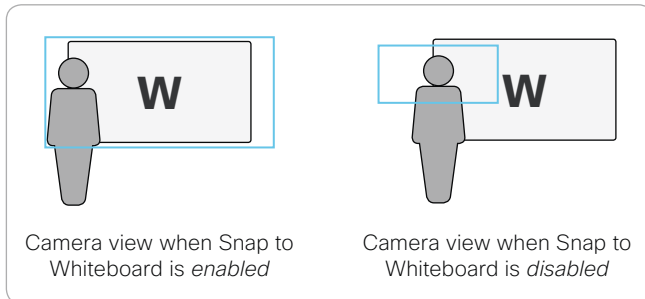

#### From the Touch controller

1. Tap the contact information in the upper left corner of the Touch controller and open the *Settings* menu.
2. Tap *Snap to Whiteboard*.

Sign in with ADMIN credentials if the *Settings* menu is protected by a passphrase on your video system.

3. Set the toggle switch to:

**Enabled:** Snap to Whiteboard is enabled, and the camera will capture both the person that speaks and the whiteboard he or she is standing next to.

**Disabled:** Snap to Whiteboard is disabled, and the camera will capture only the person that speaks.

#### From the web interface

1. Sign in to the web interface and navigate to *Setup > Configuration*.
2. Find the *Cameras > SpeakerTrack > Whiteboard > Mode* setting.

**On:** Snap to Whiteboard is enabled, and the camera will capture both the person that speaks and the whiteboard he or she is standing next to.

**Off:** Snap to Whiteboard is disabled, and the camera will capture only the person that speaks.

### How to switch on speaker tracking

Speaker tracking, which can be switched on and off by the user at any time, must be switched on for the Snap to Whiteboard extension to work.

Tap the camera icon in the status bar of the Touch controller, and use the toggle button to switch speaker tracking on and off.

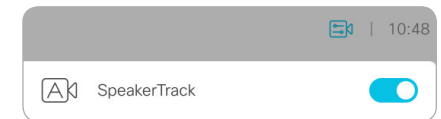

## Set up the PresenterTrack feature (page 1 of 5)

The PresenterTrack feature enables the camera to follow the presenter, while the presenter moves about on stage. When the presenter leaves the stage the tracking stops.

A system administrator must define the *stage area* and the *trigger zone*. We recommend you to be in the room while setting up PresenterTrack.

### Prerequisites

The PresenterTrack is supported with:

- Codec Plus with Precision 60 camera
- Room 70 with Precision 60 as external camera
- Codec Pro with Precision 60 camera or SpeakerTrack 60 camera
- Room 70 G2 with Precision 60 as external camera
- MX700 or MX800 with single or dual camera
- SX80 with Precision 60 camera or SpeakerTrack 60 camera

### PresenterTrack feature

- Supports two persons in the cropped image.
- Can be used in combination with Briefing Room mode.
- You can use one of the SpeakerTrack 60 cameras for PresenterTrack.
- The camera uses digital pan, tilt and zoom, so it will not move physically.
- PresenterTrack and SpeakerTrack cannot be used simultaneously. When you activate PresenterTrack, SpeakerTrack is disabled, and vice versa.

The exception is when using the Briefing Room set-up – both are active simultaneously in Q&A mode (when someone in the local audience asks a question, while the system is in *Local Presenter* mode).

### Plan the room and the stage area

Consider where to place the camera, that is used for presenter tracking, to obtain an optimal user experience.

Allow the audience or meeting participants to move naturally in the room, without being tracked unintended.

The stage area is the zoomed-out overview image. Make it large enough so the presenter can move about on stage. When the presenter leaves the stage area the tracking stops.

### Plan the trigger zone

The trigger zone is the area where presenter tracking is triggered. The trigger zone must cover an area that enables the detection of a presenter's face.

Choose a location where the presenter(s) naturally will enter the stage, for example by the speakers podium or presenters desk. The trigger zone is not visible for person(s) coming up on stage, so make it easy for the person to be detected.

To avoid false face detection, make sure the background of the trigger zone is neutral. Avoid having the trigger zone in front of a monitor.

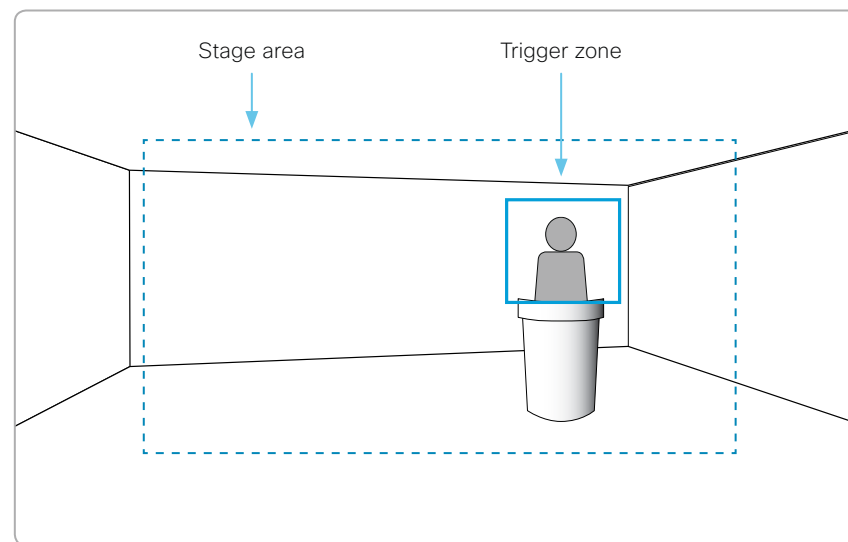

## Set up the PresenterTrack feature (page 2 of 5)

**Step 1: Position the camera** Sign in to the web interface:

1. Navigate to [Setup > Presenter Tracking](#).
2. Check the [Enable PresenterTrack](#) check box.
3. Click [Configure...](#) to open the configuration page.

When you click the [Configure...](#) button on the video system's web interface, this will happen:

- Standby is deactivated.
- Full screen self-view is enabled.
- The trigger zone rectangle is shown on screen.
- If already active, the PresenterTrack feature is deactivated.



Note that if you leave this web page at this stage, without doing any changes, the trigger zone rectangle is still visible on the video system's screen.

- If you are not in the room: Click the [Done](#) button to remove the trigger zone rectangle on the screen.
- If you are in the room: Tap the [Camera](#) icon on the Touch controller and choose a camera position from the list.

4. Choose a camera from the [Camera source](#) drop down list. A Precision 60 or SpeakerTrack 60 camera is required to enable the PresenterTrack feature. If the camera does not meet the requirements you will see a notification. Define the stage area. Use the Touch controller to adjust the full screen self-view (zoom, pan, tilt) if necessary. The camera must cover the stage area that is used by a presenter. When the presenter leaves the stage the camera will stop following the presenter.

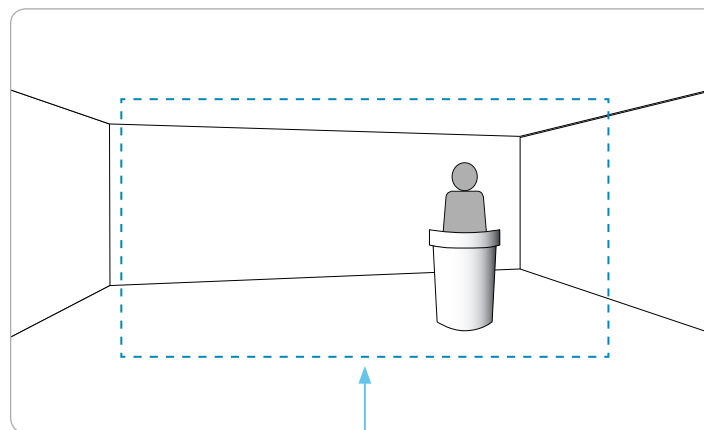

**Stage area:** The zoomed out overview image. Make it large enough so that the presenter can move around. When the presenter leaves the stage area the tracking stops.

### Tip

- We recommend that you are in the room when you configure the PresenterTrack feature.
- Use the Touch controller to adjust the camera (zoom, pan, tilt) to define the stage area.
- Use the video system's web interface to define the trigger zone. At the same time, watch the screen of the video system to see the result.
- Activate the PresenterTrack feature from the camera panel on the Touch controller.



## Set up the PresenterTrack feature (page 3 of 5)

### Step 2: Set the trigger zone

The trigger zone defines the area where presenter tracking is triggered.

You cannot see the video from the room in the web interface. An empty gray area represents the camera view and a dashed rectangle represents the trigger zone. Watch the video system screen to see the video from the room, together with the same dashed rectangle as you see in the web interface.

- Adjust the size and location of the trigger zone to cover a suitable area to detect a presenter's face. The change you do on the video system's web interface is reflected on the video system screen.
- The trigger zone must be large enough to detect a presenter face. Have in mind that people are of different heights.

Click [Save](#).

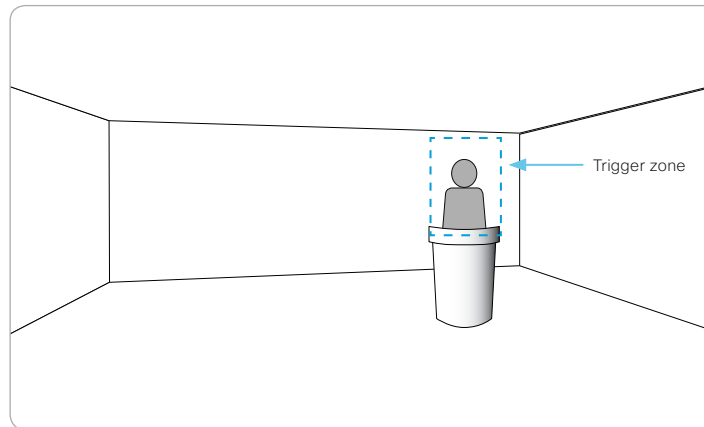

Video system screen: See the video from the room when you set the trigger zone.

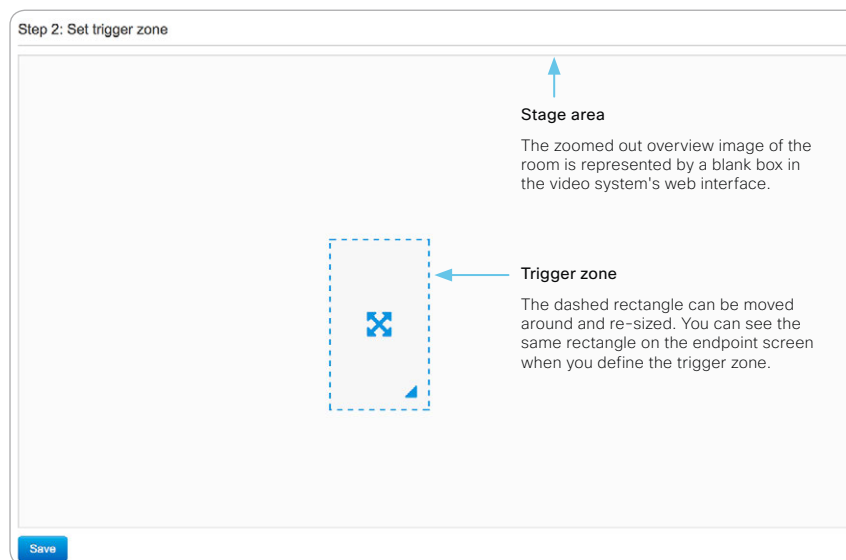

Web interface: Set the trigger zone.

### A polygonal trigger zone

You can set up a rectangular trigger zone from the [Presenter Tracking](#) web page.

If you want to define a polygonal trigger zone, you must go to the [Setup > Configuration](#) page, and find the [Cameras > PresenterTrack > TriggerZone](#) setting.

The value of this setting is a string composed of the coordinate pairs of the vertices of the polygon.

#### Example:

Define the following trigger zone, which has 12 vertices.

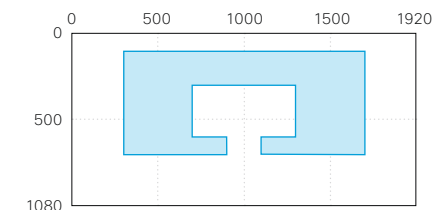

The coordinates of the vertices are:

(300,100)	→	(1100,600)	→	(700,600)
(1700,100)	→	(1300,600)	→	(900,600)
(1700,700)	→	(1300,300)	→	(900,700)
(1100,700)	→	(700,300)	→	(300,700)

The corresponding setting value is:

[Cameras > PresenterTrack > TriggerZone](#):  
 300,100,1700,100,1700,700,1100,700,  
 1100,600,1300,600,1300,300,700,300,  
 700,600,900,600,900,700,300,700

## Set up the PresenterTrack feature (page 4 of 5)

### Step 3: Test PresenterTrack in action

Activate PresenterTrack.

1. Tap the *Camera* icon in the upper right corner of the Touch controller.
2. Select *Presenter* from the list of camera positions to activate presenter tracking.
3. The camera is now ready for presenter tracking, and you can test the feature:
  - a. Position yourself in the trigger zone.
  - b. When you are detected the camera zooms in on you. Walk back and forth on stage and check that the camera follows you.
  - c. Leave the stage area to stop presenter tracking.

If necessary, go back to Step 1 or Step 2 to adjust the size of the stage area or the trigger zone.

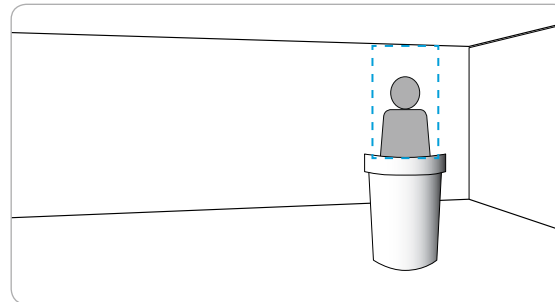

a. Position yourself in the trigger zone.

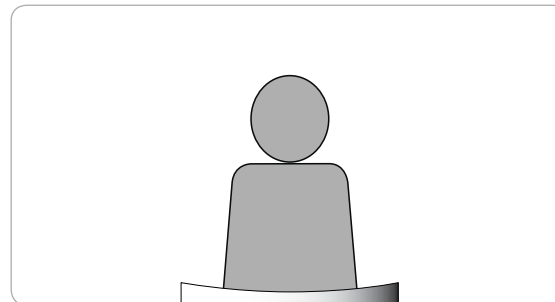

b. The camera zooms in on the presenter.

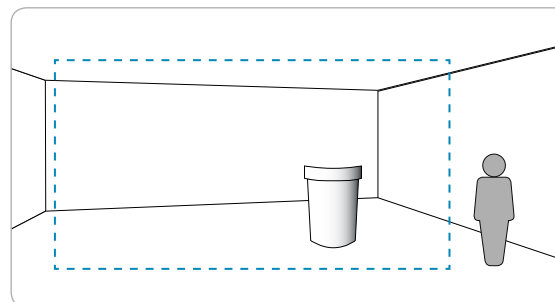

c. Leave the stage to stop presenter tracking.

### User scenarios

We do not support tracking of more than one person, but sometimes more than one person is in the cropped image.

When multiple faces are in the cropped image, the faces will be tracked as long as they all move in the same direction. If they move in different directions the tracking stops and the image zooms out and show the stage area. To start the presenter tracking again, the presenter must go to the trigger zone to be detected.

*Scenario 1:* A person is interviewed by another. They are both followed by the camera as long as they stand still or move in the same direction.

*Scenario 2:* When a presenter is replaced by another the tracking stops. The new presenter must move into the trigger zone to be detected by the camera.

If you need to disable, and thereafter enable, presenter tracking in a controlled manner this can be done on the Touch controller.

1. Tap the *Camera* icon in the status bar.
2. Deselect *Presenter* from the list of camera positions to disable PresenterTrack, and select *Presenter* again to enable the feature.

## Set up the PresenterTrack feature (page 5 of 5)

### Diagnostics mode

In order to troubleshoot you can set the video system in PresenterTrack diagnostics mode.

- Sign in to the xAPI and run the following command.  
`xCommand Cameras PresenterTrack Set Mode: Diagnostic`

In diagnostics mode the video system screen shows the stage area (the zoomed out overview image), and the indicators:

- RED: The trigger zone.
- YELLOW: The cropped image that shows a zoomed in view of the presenter.
- GREEN: A face is detected and it is tracked.
- GREEN BLINKING, FILLED: Indicates a positive face detection. If the tracked individual does not get a valid face-read the square will become red.
- RED BLINKING, FILLED: Indicates a false face detection. After some seconds the tracking will stop.
- BLUE: A face is detected but the face is not tracked.

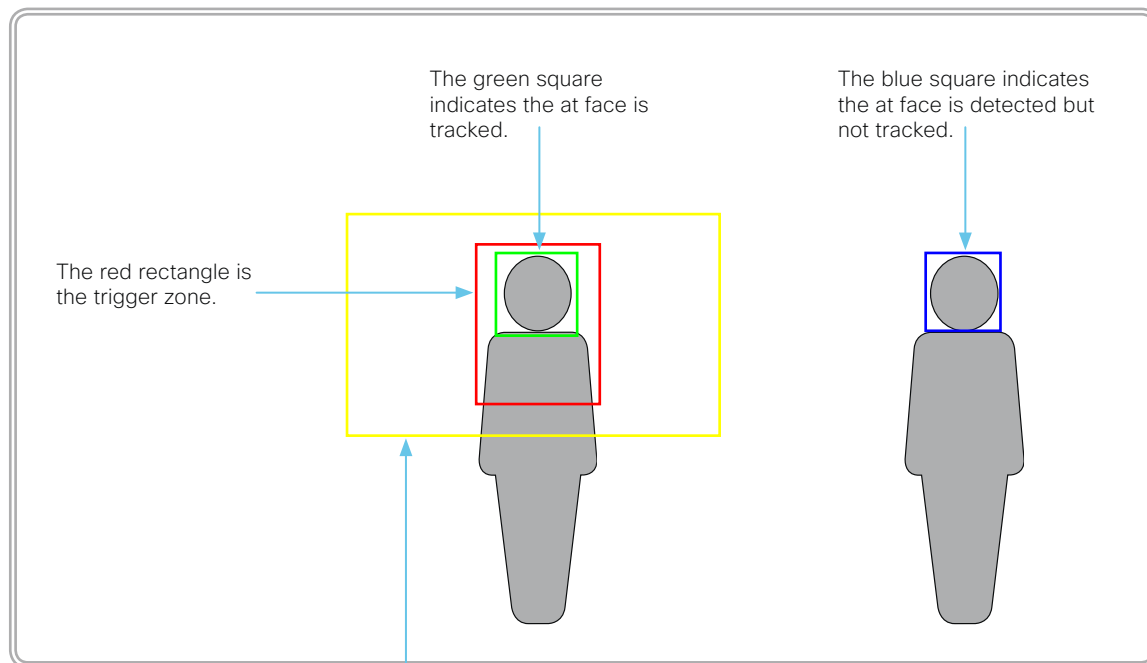

The yellow rectangle is the cropped image that follows the presenter. The yellow rectangle is not visible until a person steps into the trigger zone and is being tracked.

## Briefing room set-up (page 1 of 6)

The briefing room set-up is designed to provide easy set up, management and use of a room for education, training or similar.

The set-up is tailored around the following room modes:

- *Local Presenter* (the presenter is in the room)
- *Remote Presenter* (the presenter is calling in)
- *Discussions* (for discussions between different sites with a local presenter in the room)

The briefing room is available as a room type template, which means that the required configurations are pushed automatically to the video system when you select the template.

In order for these configurations to match the room, it is important that the room is set up correctly, and that cameras and displays are connected exactly as specified in this chapter.

### Products supporting Briefing room

Codecs:

- SX80
- Codec Pro

Integrated video systems:

- MX700, MX800 Single, MX800 Dual
- Room 70 Single G2, Room 70 Dual G2

### Required equipment

- Three displays (Presentation display, Remote presenter display, and Remote audience display)
- Two cameras (Audience camera and Presenter camera)
- Microphones
- Speakers
- Touch 10 user interface.



Briefing room set-up \*

\* The illustration shows a codec with Speaker Track 60 camera as audience camera. The same principle applies also to the supported integrated systems, and other supported codec and camera combinations.

## Briefing room set-up (page 2 of 6)

### Room modes

The set-up is tailored around the following pre-defined room modes\*:

#### Local Presenter mode



The presenter is in the room.

The local presenter mode also covers the case when someone in the local audience asks a question (Q&A).

#### Remote Presenter mode



The presenter is calling in.

#### Discussion mode



For discussions between different sites with a local presenter in the room.

	Local Presenter mode	Remote Presenter mode	Discussion mode
<b>Video sent to the far end</b>	Sends video from the Presenter camera Q&A: Sends split-screen video from the Presenter camera and the person asking the question (Audience camera)	Sends video from the Audience camera	Sends video from the Audience camera
<b>Remote presenter display</b>	Shows the presentation	Shows the presenter that is calling in, and other remote sites (you can decide the layout locally)	Shows the remote sites that are part of the discussion (you can decide the layout locally)
<b>Presentation display</b>	Shows the presentation	Shows the presentation	Shows the presentation
<b>Remote audience display</b>	Shows the remote participants that are calling in from different sites	Shows the presentation	Shows the presentation

If there is no presentation, nothing will be shown on the corresponding screens (gray).

\* The illustrations show a codec with Speaker Track 60 camera as audience camera. The same principle applies also to the supported integrated systems, and other supported codec and camera combinations.

## Briefing room set-up (page 3 of 6)

### Room arrangement examples

#### Recommendation

- *Remote presenter display*: 1<sup>st</sup> screen, placed at front. For integrated systems, this is its (left) screen.
- *Presentation display*: 2<sup>nd</sup> screen, placed at front. For integrated systems with two screens, this is its right screen.
- *Remote audience display*: 3<sup>rd</sup> screen, placed further back.
- *Audience camera*: The integrated camera for systems that have that, or a Cisco Quad Camera or Cisco TelePresence SpeakerTrack 60 camera assembly. It is also possible to use a camera without speaker tracking capabilities.
- *Presenter camera*: Cisco TelePresence Precision 60 with presenter tracking enabled.
- *Microphones*: Cisco TelePresence Ceiling Microphone for good coverage of the room. Other microphone solutions can also be used.
- *Speakers*: The integrated speakers for systems that have that, or good quality stereo speakers placed next to the Presentation display and the Remote presenter display.

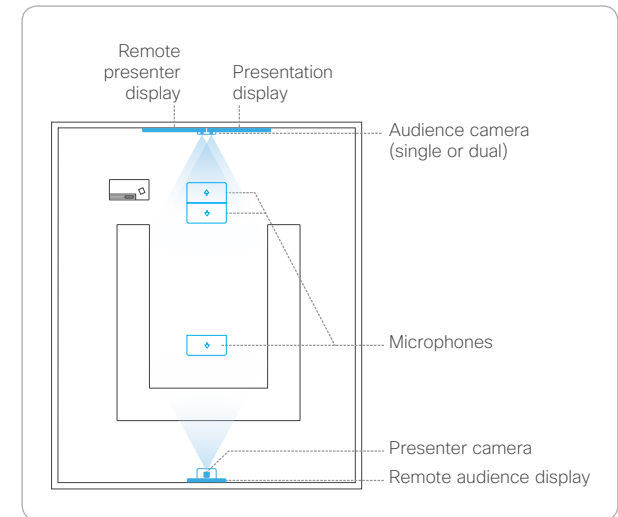
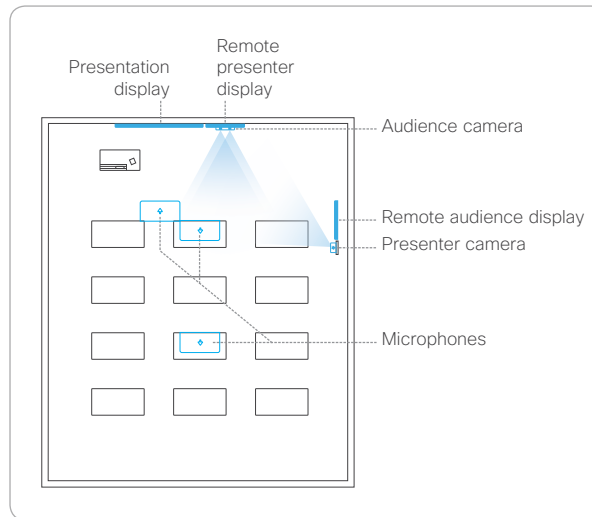

## Briefing room set-up (page 4 of 6)

### Connect cables

 It is very important to connect the cameras and monitors to the video system as illustrated; otherwise the configuration that is pushed to the video system when selecting the *Briefing* room type template will not match your actual set-up.

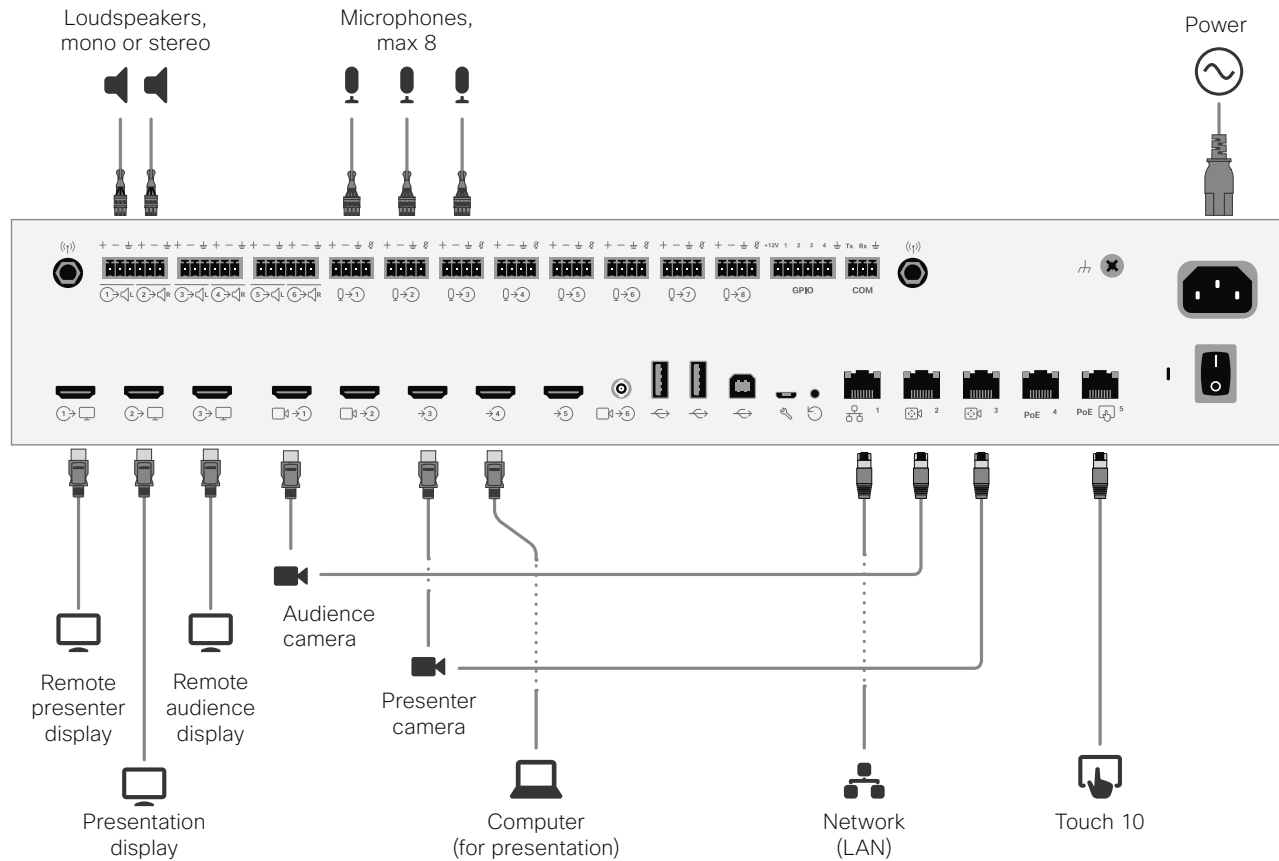

<sup>1</sup> If the Audience camera is a Cisco TelePresence SpeakerTrack 60 camera, you should use camera input 1 and 2 for the Audience camera and camera input 3 for the Presenter camera.

## Briefing room set-up (page 5 of 6)

### Configure the video system

1. Connect cameras and screens as described on the previous page.
2. It is important that the *Presenter camera* is not being shared. Use the Touch interface to stop sharing the video from the Presenter camera.
3. Sign in to the web interface, and navigate to [Setup > Configurations](#).
4. Go to the [Video > Input > Connector 3](#) section, and set the following:
  - *InputSourceType*: **camera**
  - *PresentationSelection*: **Manual**
  - *Quality*: **Motion**
  - *Visibility*: **Never**
  - *CameraControl Mode*: **On**
 Click [Save](#) for the changes to take effect.
5. Set up PresenterTrack for the *Presenter camera*, see the [▶ Set up the PresenterTrack](#) feature chapter.
6. Navigate to [Setup > Room Types](#) in the web interface.
7. Click the [Briefing](#) thumbnail to push the corresponding configuration to the video system.

### Change room mode while in a conference

Switching between room modes (*Local Presenter*, *Remote Presenter*, *Discussions*), which implies that camera input sources, and remote and local screen layouts, are changed, can be done in two ways:

- Automatically, based on who is speaking and whether a local presenter are present on stage.
- Manually, using the buttons on the Touch user interface.

### Choose between automatic or manual switching between room modes

1. Sign in to the web interface, and navigate to [Setup > Configuration](#).
2. Use the [Cameras > PresenterTrack > PresenterDetectedStatus](#) setting to determine whether to enable (default) or disable automatic switching between *Local Presenter* and *Remote Presenter* modes. The room mode will not change automatically if the current mode is *Discussions*.

### Switch room modes automatically

Only supported with Cisco TelePresence Precision 60 as Presenter camera, and the PresenterTrack feature enabled (*Cameras PresenterTrack Enabled* set to **True**).

Automatic switching implies:

- The system switches to *Local Presenter* mode when a person is detected in the PresenterTrack trigger zone.
- The system switches to *Remote Presenter* mode when the local presenter, who is tracked, leaves the stage.
- If someone in the local audience asks a question, while the system is in *Local Presenter* mode, the system sends split-screen video of both the presenter and the person asking the question. This requires Cisco TelePresence SpeakerTrack 60 or Cisco Webex Quad Camera as Audience camera, and that speaker tracking is switched on.

### Switch to another room mode manually

While in a conference, you can switch to another mode using the Touch controller.

1. Tap [Briefing Room](#) on the Touch controller.
2. Tap the mode you want to change to.

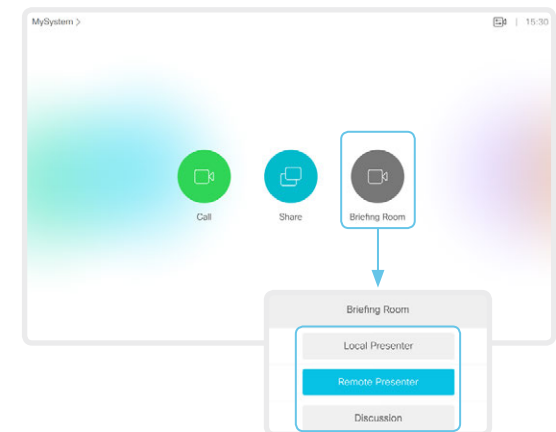



## Briefing room set-up (page 6 of 6)

### Limitations

These features are not supported when using *Briefing Room*:

- MultiSite (embedded multipoint switch)
- H.265 video encoding
- Content sharing to Proximity clients
- Directional audio
- Snap to Whiteboard
- Active control (selection of layouts from CMS)

## Classroom set-up (page 1 of 5)

The *Classroom* set-up is designed to provide easy set up, management and use of a room for education, training or similar.

The *Classroom* is available as a room type template, which means that the required configurations are pushed automatically to the video system when you select the template.

In order for these configurations to match the room, it is important that the room is set up correctly, and that the cameras are connected exactly as specified in this chapter.

### Required equipment

- One or more screens (configurable).
- Two cameras (Audience camera and Presenter camera)
- Microphones
- Speakers
- Touch 10 user interface.

### Classroom versus Briefing Room set-up

The *Classroom* set-up is more flexible than the *Briefing room* set-up, which is available for SX80, Codec Pro, MX700, MX800 and Room 70 G2, when it comes to the number of screens and how the layout is distributed on the screens.

In *Classroom* you can use any number of screens, as long as it is supported by the video system, typically two or three. You must use the video monitor settings to configure the distribution of layouts on the screens, if the default behavior does not fulfil your requirements.

In *Briefing room* you have to use three screens, and the layouts on the screens are pre-configured (and fixed) to match that particular scenario.

### Room modes

The *Classroom* set-up is tailored around the following pre-defined room modes: Local Presenter, Remote Presenter, and Discussion.

#### Local Presenter mode

- The presenter is in the room.
  - The local presenter mode also covers the case when someone in the local audience asks a question (Q&A).
- Sends video from the Presenter camera to the far end.
  - Q&A: Sends split-screen video from the Presenter camera and the person asking the question (Audience camera) to the far end.

#### Remote Presenter mode

- The presenter is calling in.
- Sends video from the Audience camera to the far end

#### Discussion mode

- For discussions between different sites with a local presenter in the room.
- Sends video from the Audience camera to the far end

### Products supporting Classroom

Codecs:

- SX80, Codec Pro, Codec Plus

Integrated video systems:

- MX700, MX800 Single, MX800 Dual
- Room 55 Dual
- Room 70 Single, Room 70 Dual
- Room 70 Single G2, Room 70 Dual G2

## Classroom set-up (page 2 of 5)

### Room arrangement examples

#### Recommendation

##### *Audience camera:*

- The integrated camera for systems that have that, or a Cisco Quad Camera or Cisco TelePresence SpeakerTrack 60 camera assembly. In general we recommend a camera with speaker tracking, but it is also possible to use a camera without speaker tracking capabilities.

##### *Presenter camera:*

- Cisco TelePresence Precision 60 with presenter tracking enabled.

##### *Microphones:*

- Cisco TelePresence Ceiling Microphone for good coverage of the room. Other microphone solutions can also be used.

##### *Speakers:*

- The integrated speakers for systems that have that, or good quality stereo speakers placed next to the main screen in the front of the room.

##### *Screens:*

- You can use one or more screens (the maximum number of screens are determined by the video system).
- For most set-ups, Cisco recommends that you use two screens (or more): A main screen placed at the front of the room, and a second screen on the side or at the back, so that the local presenter can see the remote audience.

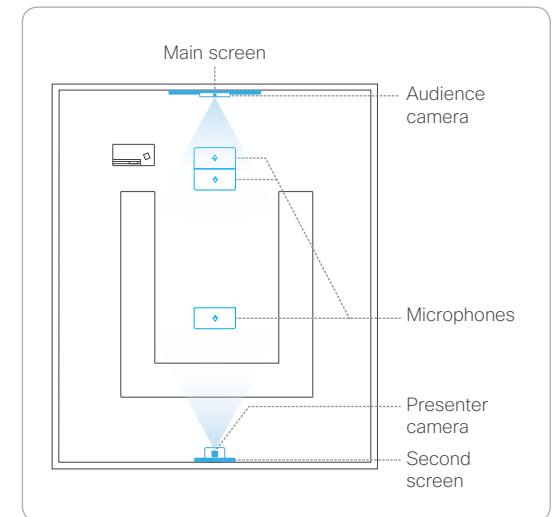
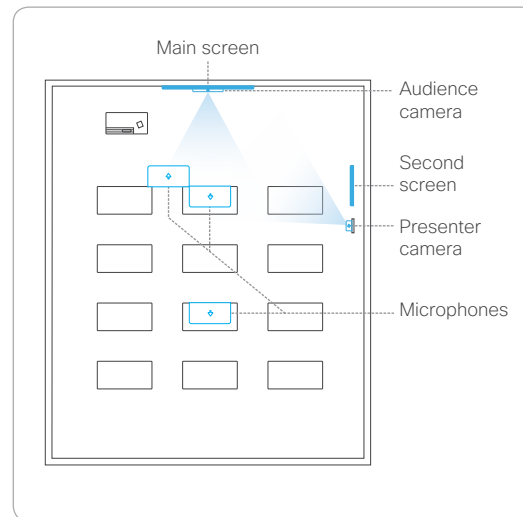

## Classroom set-up (page 3 of 5)

### Connect cables

 It is important to connect the cameras to the video system as illustrated; otherwise the configuration that is pushed to the video system when selecting the *Classroom* room type template will not match your actual set-up.

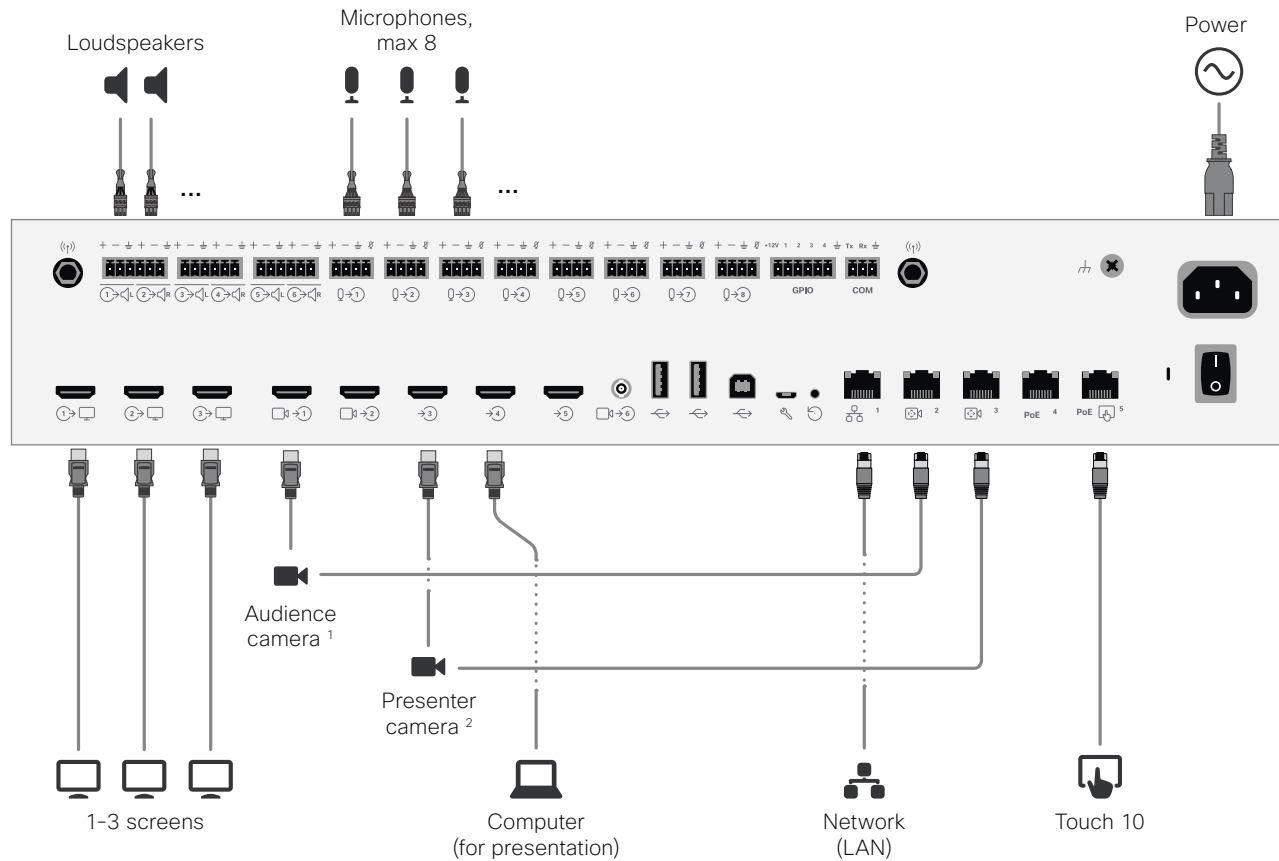

<sup>1</sup> If the Audience camera is a Cisco TelePresence SpeakerTrack 60 camera, you should use camera input 1 and 2 for the Audience camera and camera input 3 for the Presenter camera.  
<sup>2</sup> You may connect the Presenter camera to HDMI input 2 instead of input 3, if input 2 is available.

## Classroom set-up (page 4 of 5)

### Configure the video system

1. Connect cameras and screens as described on the previous page.
2. It is important that the *Presenter camera* is not being shared. Use the Touch interface to stop sharing the video from the Presenter camera.
3. Sign in to the web interface, and navigate to [Setup > Configurations](#).
4. Go to the [Video > Input > Connector 3](#) section, and set the following: \*
  - **InputSourceType:** camera
  - **PresentationSelection:** Manual
  - **Quality:** Motion
  - **Visibility:** Never
  - **CameraControl Mode:** On

Click [Save](#) for the changes to take effect.

5. Set up PresenterTrack for the *Presenter camera*, see the [▶Set up the PresenterTrack](#) feature chapter.
6. If the default screen and layout behavior does not suit your set-up, you must configure the screens and layouts using the following settings:
  - [Video > Monitors](#): Defines the number of different layouts in your room set-up.
  - [Video > Output > Connector n > MonitorRole](#): Defines which layout each screen will get. Screens with different monitor roles get different layouts.

Refer to the chapter about connecting monitors for details.

7. Navigate to [Setup > Room Types](#) in the web interface.
8. Click the [Classroom](#) thumbnail to push the corresponding configuration to the video system.

### Change room mode while in a conference

Switching between room modes (*Local Presenter*, *Remote Presenter*, *Discussions*), which implies that camera input sources, and remote and local screen layouts, are changed, can be done in two ways:

- Automatically, based on who is speaking and whether a local presenter are present on stage.
- Manually, using the buttons on the Touch user interface.

### Choose between automatic or manual switching between room modes

1. Sign in to the web interface, and navigate to [Setup > Configuration](#).
2. Use the [Cameras > PresenterTrack > PresenterDetectedStatus](#) setting to determine whether to enable (default) or disable automatic switching between *Local Presenter* and *Remote Presenter* modes. The room mode will not change automatically if the current mode is *Discussions*.

### Switch room modes automatically

Only supported with Cisco TelePresence Precision 60 as Presenter camera, and the PresenterTrack feature enabled ([Cameras PresenterTrack Enabled](#) set to **True**).

Automatic switching implies:

- The system switches to *Local Presenter* mode when a person is detected in the PresenterTrack trigger zone.
- The system switches to *Remote Presenter* mode when the local presenter, who is tracked, leaves the stage.
- If someone in the local audience asks a question, while the system is in *Local Presenter* mode, the system sends split-screen video of both the presenter and the person asking the question. This requires Cisco TelePresence SpeakerTrack 60 or Cisco Webex Quad Camera as Audience camera, and that speaker tracking is switched on.

### Switch to another room mode manually

While in a conference, you can switch to another mode using the Touch controller.

1. Tap [Classroom](#) on the Touch controller.
2. Tap the mode you want to change to.

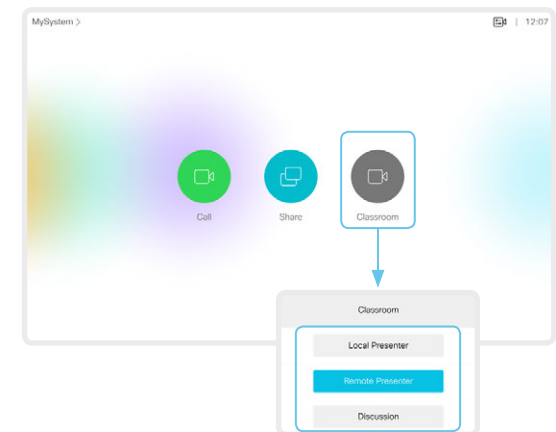

\* Assuming that the Presenter camera is connected to Connector 3. If you have connected the Presenter camera to Connector 2, go to the [Video > Input > Connector 2](#) section instead.

## Classroom set-up (page 5 of 5)

### Limitations

These features are not supported when using *Classroom*:

- MultiSite (embedded multipoint switch)
- Content sharing to Proximity clients
- Directional audio
- Snap to Whiteboard

## Connect the Touch 10 controller (page 1 of 4)

Touch 10 must either be directly connected to the video system as described on this page, or paired to the video system via the network (LAN) as described on the next page. The latter is referred to as remote pairing.

### Connect Touch 10 directly to the video system

Connect Touch 10 to the video system's dedicated Touch (RJ-45) port as illustrated.

#### Touch 10 set-up

Once Touch 10 is connected to power, the set-up procedure begins. Follow the instructions on screen.

If Touch 10 needs software upgrade, new software will be downloaded from the video system and installed on the unit automatically as part of the set-up procedure. Touch 10 restarts after the upgrade.

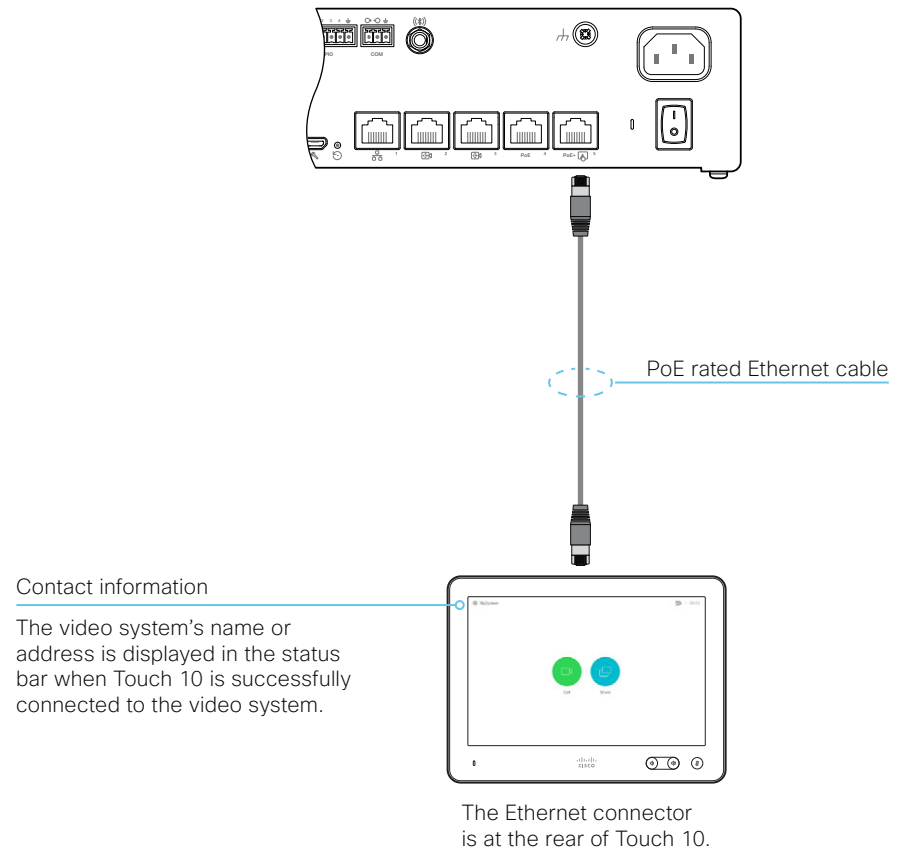

## Connect the Touch 10 controller (page 2 of 4)

### Connect Touch 10 to the video system via the network (LAN)

Connect Touch 10 and the video system to network wall sockets or to a network switch as illustrated.

#### Touch 10 set-up

Once Touch 10 is connected to power, the set-up procedure begins. Follow the instructions on screen.

When the [Select a room system](#) screen appears, note the following:

- A list of video systems signalling that they are available for pairing will show up on the screen. Tap the name of the video system you want to pair with.

Note that the following must be fulfilled for a video system to show up in the list:

- The video system and Touch 10 must be on the same subnet.
- The video system must have been restarted within the last 10 minutes. If the video system does not appear in the list, try restarting it.
- If the video system does not appear in the list of available systems, enter its IP address or hostname in the input field. Tap [Connect](#).
- You have to log in with username and passphrase for the pairing process to commence. Tap [Login](#).

A user with the USER role is sufficient; you do not need the ADMIN role to perform this task.

Read more about how to create a user account and assign a role to it in the [User administration](#) chapter.

If Touch 10 needs software upgrade, new software will be downloaded from the video system and installed on the unit automatically as part of the set-up procedure. Touch 10 restarts after the upgrade.

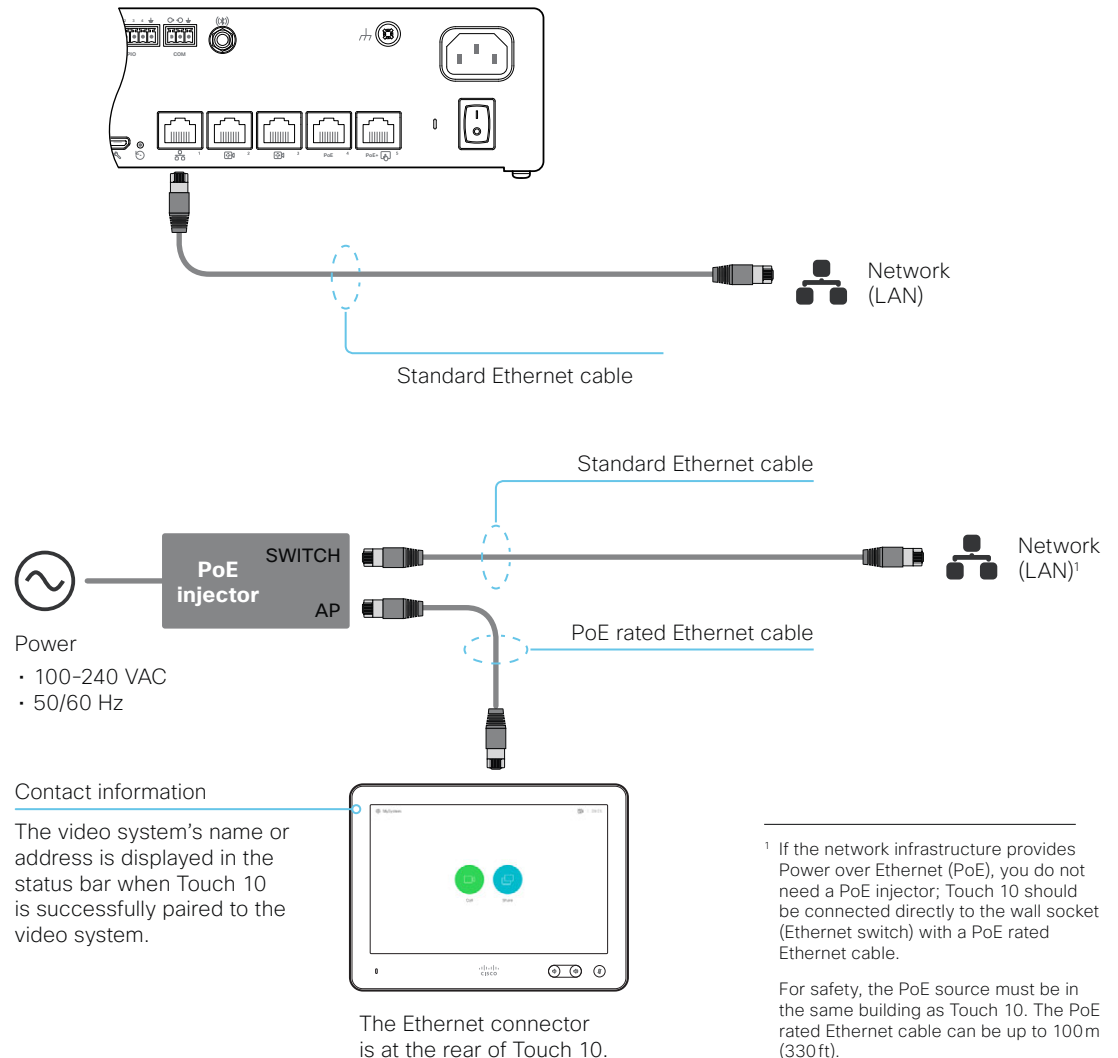



## Connect the Touch 10 controller (page 3 of 4)

### Cisco Touch 10 physical interface

This is the new version of the Touch 10 controller launched late 2017. It has the same functionality as the previous version, but has a slightly different physical interface. The new device is identified by the logo on front, and fewer connectors at the back.

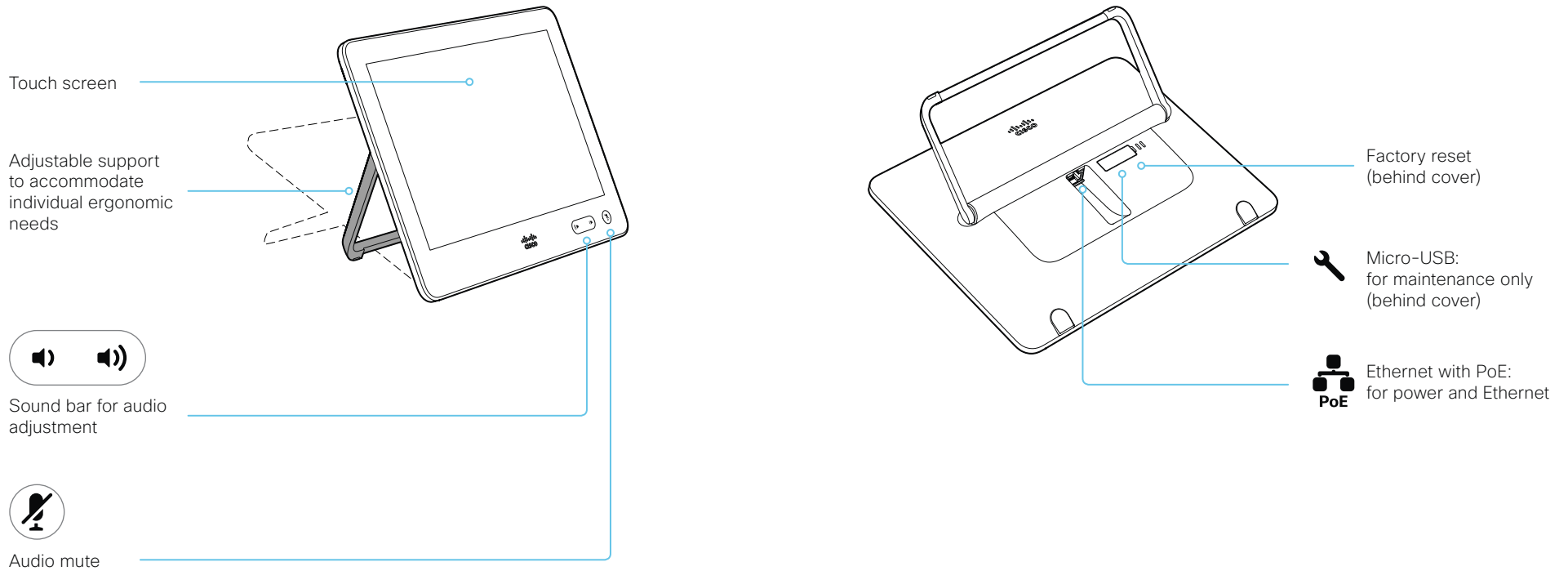

## Connect the Touch 10 controller (page 4 of 4)

### Cisco TelePresence Touch 10 physical interface

See next page for a newer version of the Touch 10 controller.

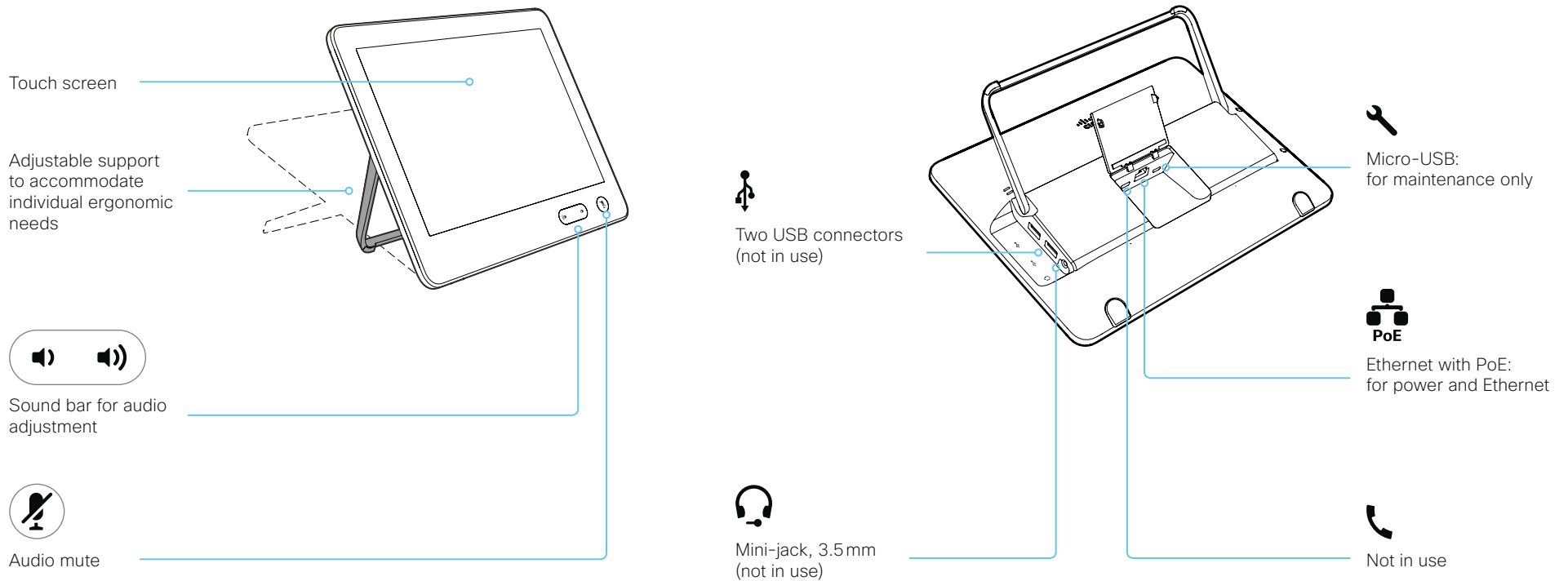

## Connect the ISDN Link

The ISDN Link enables a video system to use ISDN lines for connectivity, and enables both video calls and telephone calls over the PSTN (Public Switched Telephone Network).

ISDN Link support ISDN BRI, ISDN PRI and V.35. ISDN can be used in addition to regular IP connectivity for SIP or H.323 calls, or without any IP infrastructure.

ISDN Link is managed from the video systems web interface. Sign in to the web interface, and navigate to [Setup > Peripherals](#).

### Requirements:

- The ISDN Link must be running IL1.1.7 software or later
- The video system (codec) must be running CE9.3 software or later. The ISDN Link must be re-paired with the video system after the video system has been converted from TC software to CE software.
- The video endpoint must have IPv6 enabled in the web interface or API in order to communicate with the ISDN Link
- Observe the network topology in the ISDN Link Installation Guide in order to guarantee a successful installation
- The video system and ISDN Link must be on the same subnet. If the endpoint or ISDN Link are assigned new IP addresses they will only remain paired as long as they are kept in the same subnet.

### Limitations:

- Video systems that are registered to the Cisco Webex cloud service are not able to use ISDN Link.

## Setup and configuration

When converting the video system from TC (TC6 or later) to CE software (CE9.3 or later) the ISDN Link will automatically be unpaired due to security reasons.

More information about ISDN Link (Release Notes, Installation Guide, Administrator Guide, API Guide, Compliance and Safety guide) is found here: <https://www.cisco.com/go/isdnlink-docs>

## Setup with LAN and direct connection between the video system and ISDN Link

This is the recommended setup. But there are other options, so see the user documentation for additional examples: <https://www.cisco.com/go/isdnlink-docs>

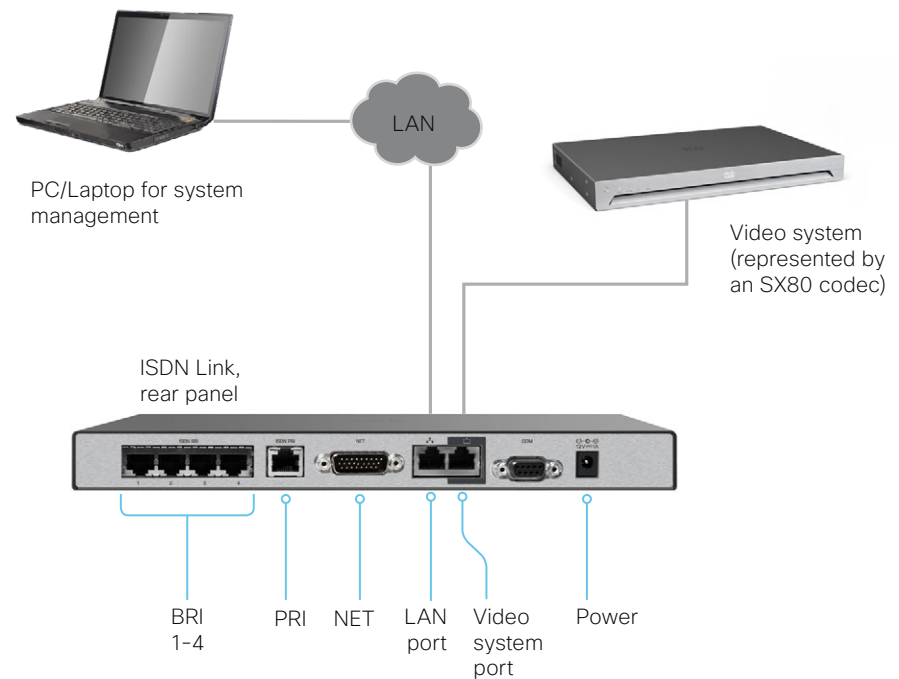



## Chapter 4

# Maintenance

## Upgrade the system software

Sign in to the web interface and navigate to [Maintenance > Software Upgrade](#).

### Download new software

For software download, go to the Cisco Download Software web page, and select your product:

► <https://software.cisco.com/download/home>

Each software version has a unique file name. The format of the file name is "s53200ce9\_5\_x.cop.sgn."

### Install new software

Download the appropriate software package and store it on your computer. This is a .cop.sgn file. Don't change the file name.

1. Click [Browse...](#) and find the .cop.sgn file that contains the new software.

The software version will be detected and shown.

2. Click [Install software](#) to start the installation process.

The complete installation normally take no longer than 15 minutes. You can follow the progress on the web page. The video system restarts automatically after the installation.

You must sign in anew in order to continue working with the web interface after the restart.

### Software release notes

For a complete overview of the news and changes, we recommend reading the Software Release Notes (CE9).

Go to: ► <https://www.cisco.com/c/en/us/support/collaboration-endpoints/spark-room-kit-series/tsd-products-support-series-home.html>

### About software versions

This video conference system is using CE software. The version described in this document is CE9.5.x.

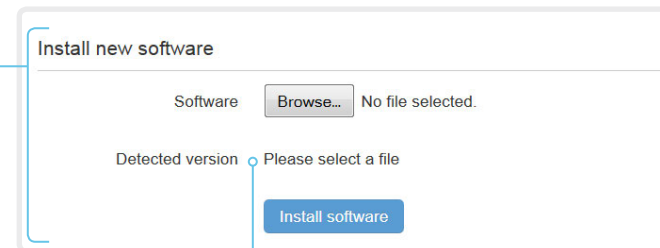

### Check new software version

When you have selected a file, the software version is shown here

## Add option keys

Sign in to the web interface and navigate to [Maintenance > Option Keys](#).

You see a list of all option keys, also the ones that are not installed on your video system.

Contact your Cisco representative for information about how to get option keys for the uninstalled options.

### The video system's serial number

You need the video system's serial number when ordering an option key.

### Add an option key

1. Enter an *Option Key* in the text input field.
2. Click [Add option key](#).

If you want to add more than one option key, repeat these steps for all keys.

Serial number .....

Option key

Contact your Cisco representative to obtain option keys.  
You need to provide the serial number to get option keys.

[Add option key](#)

## About option keys

Your video system may or may not have one or more software options installed. In order to activate the optional functionality the corresponding *option key* must be present on the video system.

Each video system has unique option keys.

Option keys are not deleted when performing a software upgrade or factory reset, so they need to be added only once.

## System status

### System information overview

Sign in to the web interface to see the *System Information* page.

This page shows the product type, system name and basic information about the hardware, software, installed options and network address. Registration status for the video networks (SIP and H.323) is included, as well as the number/URI to use when making a call to the system.

### Detailed system status

Sign in to the web interface, and navigate to [Setup > Status](#) in order to find more detailed status information\*.

### Search for a status entry

Enter as many letters as needed in the search field. All entries that contain these letters are shown in the right pane. Entries that have these letters in their value space are also shown.

The screenshot shows the 'Status' page with a search field containing 'vol'. The left pane has 'Audio' selected. The right pane displays the 'Audio' status with the following table:

Audio	
Ultrasound Volume	70
Volume	48

### Select a category and navigate to the correct status

The system status is grouped in categories. Choose a category in the left pane to show the related status to the right.

The screenshot shows the 'Status' page with a search field. The left pane has 'Conference' selected. The right pane displays the 'Conference' status with the following table:

Conference	
ActiveSpeaker CallId	0
DoNotDisturb	Inactive
Line 1 Mode	Private
MultiSite Mode	MultiSite

\* The status shown in the illustration serve as an example. The status of your system may be different.

## Run diagnostics

Sign in to the web interface and navigate to [Maintenance > Diagnostics](#).

The diagnostics page lists the status for some common sources of errors\*.

Errors and critical issues are clearly marked in red color; warnings are yellow.

### Run diagnostics

Click [Re-run diagnostics](#) to ensure that the list is up to date.

### Leave standby mode

Click [Wake up the system](#) to wake up a video system that is in standby mode.

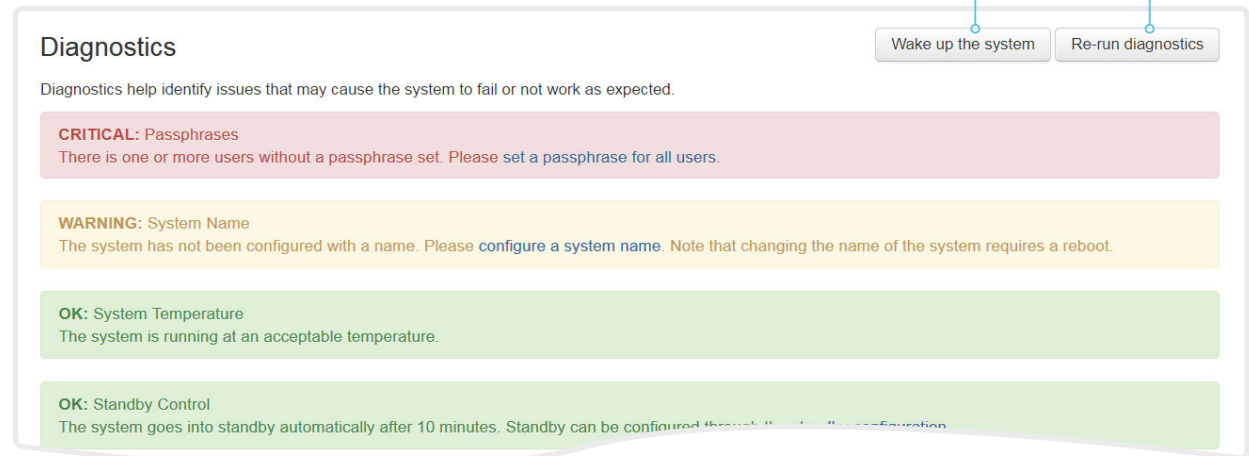

\* The messages shown in the illustration serve as examples. Your system may show other information.



## Download log files

Sign in to the web interface and navigate to [Maintenance > System Logs](#).

### Download all log files

Click [Download logs archive...](#) and follow the instructions.

An anonymized call history is included in the log files by default.

Use the drop down list if you want to exclude the call history from the log files, or if you want to include the full call history (non-anonymous caller/callee).

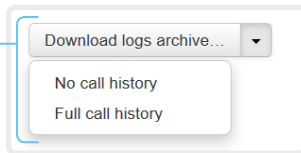

### Open/save one log file

Click the file name to open the log file in the web browser; right click to save the file on the computer.

### Start extended logging

Click [Start extended logging...](#)

Extended logging lasts for 3 or 10 minutes, depending on whether full capture of network traffic is included or not.

Click [Stop extended logging](#) if you want to stop the extended logging before it times out.

As default, the network traffic is not captured. Use the drop down menu if you want to include partial or full capture of network traffic.

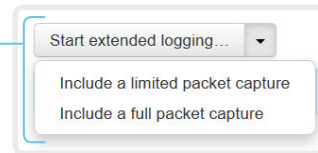

## About log files

The log files are Cisco specific debug files which may be requested by the Cisco support organization if you need technical support.

The *current log files* are time stamped event log files.

All current log files are archived in a time stamped *historical log file* each time the video system restarts. If the maximum number of historical log files is reached, the oldest one will be overwritten.

### Extended logging mode

Extended logging mode may be switched on to help diagnose network issues and problems during call setup. While in this mode more information is stored in the log files.

Extended logging uses more of the video system's resources, and may cause the video system to under-perform. Only use extended logging mode when you are troubleshooting an issue.



### Refresh a log file list

Click the refresh button for *Current logs* or *Historical logs* to update the corresponding lists.

## Create a remote support user

Sign in to the web interface, navigate to [Maintenance > System Recovery](#) and select the *Remote Support User* tab.

 The remote support user should only be enabled for troubleshooting reasons when instructed by Cisco TAC.

### Create remote support user

1. Click [Create user](#).
2. Open a case with Cisco TAC.
3. Copy the text in the *Token* field and send it to Cisco TAC.
4. Cisco TAC will generate a *password*.

The remote support user is valid for seven days, or until it is deleted.

The system does not have an active Remote Support User.

[Create user](#) [Delete user](#)

**This user is valid until**  
2018-10-05 16:50:18

**Token**

```
bgD9FjGyIUNn0TB71KcmT1FPnx6uY0vTFy9kpiUa5z1+b
TQek1PaSpsQJNEMfzThgbvK4J7pgOyt4lmCyvxWPGipJQ
GL0ynjvHBvhfqYEsSWwCSSZxQ1wP6bUPQzOSgztZnkOG7
e9CpAoRNq+mZMqEG1lsswKPZ7HYu1vyVTH/XuPzU7Nues
9pwzLc8BFgBt1xV0fKeoeOmMX+it1Ecamln4lnXlScgOt
yPSXiFWLdKAJsQHJQH20PCxxYcnEUYNpAoJiD39edLy4
etY+/SATwBIiohrgF9JLW9FfNEF+IyDlwUmYkPoEirBj7
N3Zvpivlv1Z7+NUalQW9qWTj4Ag==
```

The system has an active Remote Support User.

[Create user](#) [Delete user](#)

### Delete remote support user

Click [Delete user](#).

### About the remote support user

In cases where you need to diagnose problems on the video system you can create a remote support user.

The remote support user is granted read access to the system and has access to a limited set of commands that can aid troubleshooting.

You will need assistance from Cisco Technical Assistance Center (TAC) to acquire the password for the remote support user.

## Backup and restore configurations and custom elements

Sign in to the web interface and navigate to [Maintenance > Backup and Restore](#).

You can include custom elements as well as configurations in a backup file (zip-format). You can choose which of the following elements to include in the bundle:

- Branding images
- Macros
- Favorites
- Sign-in banner
- In-room control panels
- Configurations/settings (all or a sub-set)

The backup file can either be restored manually from the video system's web interface, or you can generalize the backup bundle so that it can be provisioned across multiple video systems, for example using Cisco UCM or TMS (see the **next** chapters).

### Create a backup file

1. Open the [Create backup](#) tab.
2. Select the elements you want to include in the backup file.  
Elements that currently don't exist on the video system are greyed out.
3. Select which settings - if any - you want to include in the backup file. Note the following:
  - As default, all settings are included in the backup file.
  - You can remove one or more settings manually by deleting them from the list on the web page.
  - If you want to remove all settings that are specific to one video system, click [Remove system-specific configurations](#).  
This is useful if you are going to restore the backup bundle on other video systems.
4. Click [Download backup](#) to store the elements in a zip-file on your computer.

### Restore a backup file

1. Choose the [Restore backup](#) tab.
2. Click [Browse...](#) and find the backup file you want to restore.  
All settings and elements in the backup file will be applied.
3. Click [Upload file](#) to apply the backup.  
Some settings may require that you restart the video system before they take effect.

### Additional information

#### Restoring macros

If a backup file that contains macros is restored on a video system the following applies:

- The macro runtime is started or restarted.
- The macros are automatically activated (started).

#### Restoring branding images

If a backup bundle contains branding images, the *UserInterface Wallpaper* setting is automatically set to **Auto**.

This means that the branding images will automatically be displayed, possibly replacing a custom wallpaper.

#### The backup file

The backup file is a zip-file that contains several files. It is important that the files are at the top level within the zip-file, and not include in a folder.

## CUCM provisioning of custom elements

A backup file, as described in the ► [Backup and restore configurations and custom elements](#) chapter, can be used as a *customization template* for multiple video systems.

The customization template (backup file) may be hosted on either:

- the CUCM TFTP file service, or
- a custom web server that can be reached by the video systems on HTTP or HTTPS.

When a video system get information from CUCM (Cisco Unified Communications Manager) about the name and location of a customization template, the video system will contact the server, download the file, and restore the custom elements.



Configurations will not be restored on the video system, even if they are part of the backup file that you use as a customization template.

Upload a customization template to the TFTP file server

1. Sign in to *Cisco Unified OS Administration*.
2. Navigate to *Software Upgrades > TFTP File Management*.
3. Click *Upload File*. Enter the name and path of the customization template in the input field.
4. Click *Upload File*.

Add customization provisioning information for each video system

1. Sign in to *Cisco Unified CM Administration*.
2. Navigate to *Device > Phone*.
3. Fill in the **Customization Provisioning** fields in the product specific configuration section of the relevant devices:
  - *Customization File*: The customization template file name (for example: backup.zip) \*
  - *Customization Hash Type*: **SHA512**
  - *Customization Hash*: The SHA512 checksum for the customization template.

If these fields are not present, you must install a newer Device Package on CUCM.

4. Click *Save* and *Apply Config* to push the configuration to the video systems.

\* If not using the TFTP Service, you must enter the complete URI for the customization template: <hostname>:<portnumber>/<path-and-filename>

For example:

- http://host:6970/backup.zip, or
- https://host:6971/backup.zip

### SHA512 checksum

**Tip!** You can find the SHA512 checksum of a file by restoring it to a video system using its web interface.

1. Sign in to the web interface and navigate to *Maintenance > Backup and Restore*.
2. Choose the *Restore backup* tab.
3. Click *Browse...* and find the file you want to calculate the checksum for.

Then you can see the SHA512 checksum at the bottom of the page.

### CUCM documentation

► <https://www.cisco.com/c/en/us/support/unified-communications/unified-communications-manager-callmanager/tsd-products-support-series-home.html>

## TMS provisioning of custom elements

A backup file, as described in the [► Backup and restore configurations and custom elements](#) chapter, can be used as a *customization template* for multiple video systems.

The backup file must be hosted on a custom web server that can be reached by the video systems on HTTP or HTTPS.

When a video system get information from TMS (TelePresence Management Suite) about the name and location of the backup file, the video system will contact the server, download the file, and restore the custom elements.

### Create and apply a configuration template

1. Create a configurations template.
2. Add a custom command containing the following XML string in the configuration template:

```
<Command>
  <Provisioning>
    <Service>
      <Fetch>
        <URL>web-server-address</URL>
        <Checksum>checksum</Checksum>
        <Origin>origin</Origin>
      </Fetch>
    </Service>
  </Provisioning>
</Command>
```

where

*web-server-address*: The URI to the backup file (for example, `http://host/backup.zip`).

*checksum*: The SHA512 checksum of the backup file.

*origin*: **Provisioning**\*

3. Select the video systems you want to push the configuration template to, and click [Set on systems](#).

Read the [► Cisco TMS administrator guide](#) for details how to create TMS configurations templates and make custom commands.

### SHA512 checksum

**Tip!** You can find the SHA512 checksum of a file by restoring it to a video system using its web interface.

1. Sign in to the web interface and navigate to [Maintenance > Backup and Restore](#).
2. Choose the [Restore backup](#) tab.
3. Click [Browse...](#) and find the file you want to calculate the checksum for.

Then you can see the SHA512 checksum at the bottom of the page.

---

\* If not setting this parameter to **Provisioning**, also configurations that are part of the backup file will be pushed to the video system. If the backup file contains configurations that are specific to one video system, for example static IP addresses, system name, and contact information, you may end up with video systems that you cannot reach.

## Revert to the previously used software image

Sign in to the web interface and navigate to [Maintenance > System Recovery](#).

We recommend you to back up the log files, configurations, and custom elements of the video system before you swap to the previously used software image.

### Back up log files, configurations and custom elements

1. Select the *Backup* tab.
2. Click [Download logs](#) and follow the instructions to save the log files on your computer.
3. Click [Download backup](#) and follow the instructions to save the backup bundle on your computer.

### Revert to the previously used software image

Only administrators, or when in contact with Cisco technical support, should perform this procedure.

1. Select the *Software Recovery Swap* tab.
2. Click [Switch to software: cex.y.z...](#), where x.y.z indicates the software version.
3. Click [Yes](#) to confirm your choice, or [Cancel](#) if you have changed your mind.

Wait while the system resets. The system restarts automatically when finished. This procedure may take a few minutes.

### About the previously used software image

If there is a severe problem with the video system, switching to the previously used software image may help solving the problem.

If the system has not been factory reset since the last software upgrade, the previously used software image still resides on the system. You do not have to download the software again.

## Factory reset the video system (page 1 of 3)

If there is a severe problem with the video system, the last resort may be to reset it to its default factory settings.



It is not possible to undo a factory reset.

Always consider reverting to the previously used software image before performing a factory reset. In many situations this will recover the system. Read about software swapping in the [► Revert to the previously used software image](#) chapter.

We recommend that you use the web interface or user interface to factory reset the video system. If these interfaces are not available, use the reset pin-hole .

A factory reset implies:

- Call logs are deleted.
- Passphrases are reset to default.
- All system parameters are reset to default values.
- All files that have been uploaded to the system are deleted. This includes, but is not limited to, custom wallpaper, certificates, and favorites lists.
- The previous (inactive) software image is deleted.
- Option keys are not affected.

The video system restarts automatically after the factory reset. It is using the same software image as before.

**We recommend that you back up the log files, configurations, and custom elements of the video system before you perform a factory reset; otherwise these data will be lost.**

## Factory reset the video system (page 2 of 3)

### Factory reset using the web interface

We recommend that you back up the log files and configuration of the video system before you continue with the factory reset.

Sign in to the web interface and navigate to [Maintenance > System Recovery](#).

1. Select the *Factory Reset* tab, and read the provided information carefully.
2. Click [Perform a factory reset...](#)
3. Click [Yes](#) to confirm your choice, or [Cancel](#) if you have changed your mind.
4. Wait while the video system reverts to the default factory settings. When finished, the video system restarts automatically. This may take a few minutes.

When the system has been successfully reset to factory settings, the Setup assistant starts with the *Welcome* screen.

### Factory reset from the user interface

We recommend that you back up the log files and configuration of the video system before you continue with the factory reset.

1. Select the contact information in the upper left corner of the user interface.
2. Select [Settings](#).
3. Select [Factory reset](#).
4. Select [Reset](#) to confirm your choice, or [Back](#) if you have changed your mind.
5. Wait while the video system reverts to the default factory settings. When finished, the video system restarts automatically. This may take a few minutes.

When the system has been successfully reset to factory settings, the Setup assistant starts with the *Welcome* screen.

### Back up log files, configurations, and custom elements

Sign in to the web interface and navigate to [Maintenance > System Recovery](#).

### Back up log files, configurations, and custom element

1. Select the *Backup* tab.
2. Click [Download logs](#) and follow the instructions to save the log files on your computer.
3. Click [Download backup](#) and follow the instructions to save the backup bundle on your computer.



## Factory reset the video system (page 3 of 3)

### Factory reset using the reset button

We recommend that you back up the log files and configuration of the video system before you continue with the factory reset.

1. Locate the reset button (pin hole) at the rear side of the codec.
2. Use a paper clip (or similar) to press and hold the recessed reset button until the screen turns black (approximately 10 seconds). Then release the button.
3. Wait while the video system reverts to the default factory settings. When finished, the video system restarts automatically. This may take a few minutes.

When the system has been successfully reset to factory settings, the Setup assistant starts with the *Welcome* screen.

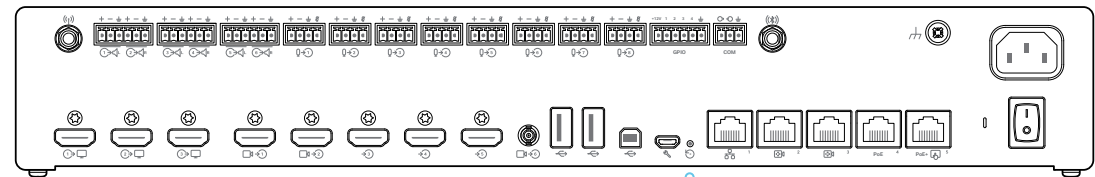

Reset button (pin hole)

## Factory reset Cisco Touch 10

**This chapter applies to the new Touch 10 controller that was launched late 2017 (Cisco Touch 10).** This device is identified by the logo on front, and fewer connectors at the back.

See the next page for the older version.

In an error situation it may be required to factory reset the Touch controller to recover connectivity. This should be done only when in contact with the Cisco support organization.

When factory resetting the Touch controller the pairing information is lost, and the Touch itself (not the video system) is reverted to factory defaults.

 It is not possible to undo a factory reset.

1. Open the small cover at the rear to find the reset button.
2. Press and hold the reset button until the mute button at the front starts blinking (approximately 5 seconds). Then release the button.

Touch 10 automatically reverts to the default factory settings and restarts.

If Touch 10 is directly connected to the video system it receives a new configuration automatically from the video system.

If Touch 10 is connected via LAN the device must be paired to the video system anew. When successfully paired it receives a new configuration automatically from the video system.

### About pairing and how to connect Touch 10 to the video system

In order to use the Touch 10 controller, Touch 10 must either be directly connected to the codec, or paired to the codec via LAN. The latter is referred to as remote pairing.

Read about pairing and how to connect Touch 10 to the video system in the [Connect the Touch 10 controller](#) chapter.

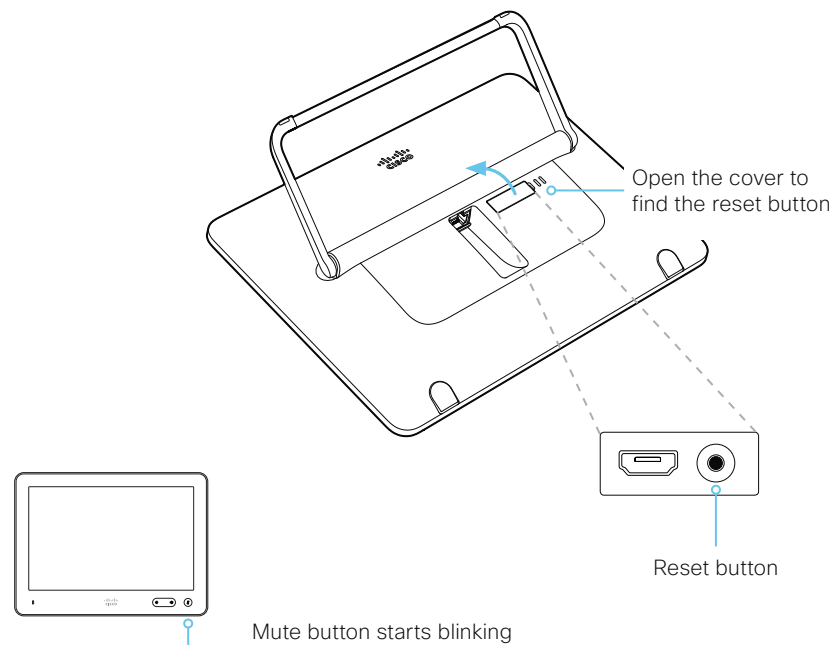

## Factory reset Cisco TelePresence Touch 10

**This chapter applies to the first Touch 10 controller (Cisco TelePresence Touch 10).** This device has no logo on front.

See the previous page for the newer version that was launched late 2017.

In an error situation it may be required to factory reset the Touch controller to recover connectivity. This should be done only when in contact with the Cisco support organization.

When factory resetting the Touch controller the pairing information is lost, and the Touch itself (not the video system) is reverted to factory defaults.



It is not possible to undo a factory reset.

1. Locate the *Mute* and *Volume down* buttons.
2. Press and hold the *Mute* button until it starts blinking (red and green). It takes approximately 10 seconds.
3. Press the *Volume down* button twice.

Touch 10 automatically reverts to the default factory settings and restarts.

If Touch 10 is directly connected to the video system it receives a new configuration automatically from the video system.

If Touch 10 is connected via LAN the device must be paired to the video system anew. When successfully paired it receives a new configuration automatically from the video system.

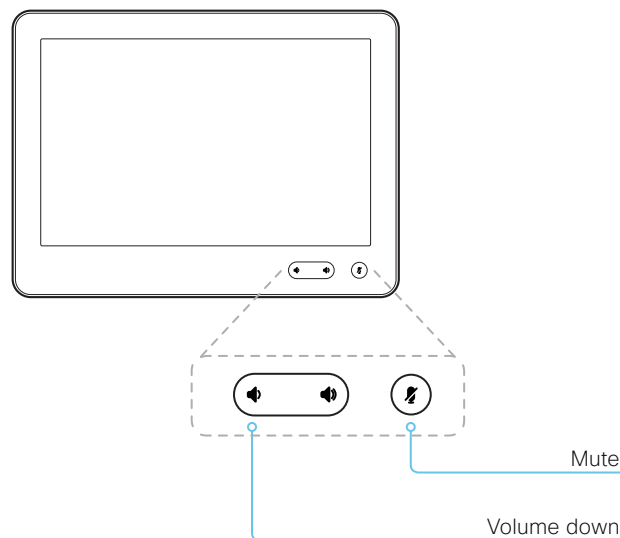

### About pairing and how to connect Touch 10 to the video system

In order to use the Touch 10 controller, Touch 10 must either be directly connected to the codec, or paired to the codec via LAN. The latter is referred to as remote pairing.

Read about pairing and how to connect Touch 10 to the video system in the [Connect the Touch 10 controller](#) chapter.

## Capture user interface screenshots

Sign in to the web interface and navigate to [Maintenance > User Interface Screenshots](#).

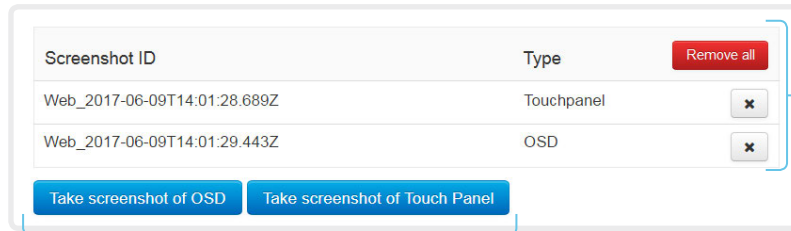

### Capture a screenshot

Click [Take screenshot of Touch Panel](#) to capture a screenshot of the Touch controller, or click [Take screenshot of OSD](#) to capture a screenshot of the on-screen display.

The screenshot displays in the area below the buttons. It may take up to 30 seconds before the screenshot is ready.

All captured snapshots are included in the list above the buttons. Click the screenshot ID to display the image.

### Delete screenshots

If you want to delete all screenshots, click [Remove all](#).

To delete just one screenshot, click the  button for that screenshot.

### About user interface screenshots

You can capture screenshots both of a Touch controller that is connected to the video system, and of the on-screen display (menus, indicators and messages on the main display).

## Chapter 5

# System settings

## Overview of the system settings

In the following pages you will find a complete list of the system settings which are configured from the [Setup > Configuration](#) page on the web interface.

Open a web browser and enter the IP address of the video system then sign in.



### How to find the IP address

1. Select the contact information in the upper left corner of the user interface.
2. Select [Settings](#), followed by [About this device](#).

<b>Audio settings</b> .....	<b>99</b>
Audio DefaultVolume.....	99
Audio Input ARC [1..3] Mode.....	99
Audio Input HDMI [1..5] Level.....	99
Audio Input HDMI [1..5] Mode.....	99
Audio Input HDMI [1..5] VideoAssociation MuteOnInactiveVideo.....	99
Audio Input Microphone [1..8] EchoControl Dereverberation.....	100
Audio Input Microphone [1..8] EchoControl Mode.....	100
Audio Input Microphone [1..8] EchoControl NoiseReduction.....	100
Audio Input Microphone [1..8] Equalizer ID.....	100
Audio Input Microphone [1..8] Equalizer Mode.....	100
Audio Input Microphone [1..8] Level.....	100
Audio Input Microphone [1..8] Mode.....	101
Audio Input Microphone [1..8] PhantomPower.....	101
Audio Input Microphone [1..8] VideoAssociation MuteOnInactiveVideo.....	101
Audio Input Microphone [1..8] VideoAssociation VideoInputSource.....	101
Audio KeyClickDetector Attenuate.....	101
Audio KeyClickDetector Enabled.....	101
Audio Microphones Mute Enabled.....	102
Audio Output ARC [1..1] Delay DelayMs.....	102
Audio Output ARC [1..1] Delay Mode.....	102
Audio Output ARC [1..1] Mode.....	102
Audio Output HDMI [1..3] Delay DelayMs.....	103
Audio Output HDMI [1..3] Delay Mode.....	103
Audio Output HDMI [1..3] Mode.....	103
Audio Output Line [1..6] Channel.....	103
Audio Output Line [1..6] Delay DelayMs.....	104
Audio Output Line [1..6] Delay Mode.....	104
Audio Output Line [1..6] Equalizer ID.....	104
Audio Output Line [1..6] Equalizer Mode.....	104
Audio Output Line [1..6] Level.....	104
Audio Output Line [1..6] Mode.....	104
Audio SoundsAndAlerts RingTone.....	105
Audio SoundsAndAlerts RingVolume.....	105
Audio Ultrasound MaxVolume.....	105
Audio Ultrasound Mode.....	105

<b>CallHistory settings</b> .....	<b>106</b>	Conference Encryption Mode.....	115
CallHistory Mode.....	106	Conference FarEndControl Mode.....	115
<b>Cameras settings</b> .....	<b>107</b>	Conference FarEndControl SignalCapability.....	116
Cameras Camera [1..7] AssignedSerialNumber.....	107	Conference FarEndMessage Mode.....	116
Cameras Camera [1..7] Backlight DefaultMode.....	107	Conference IncomingMultisiteCall Mode.....	118
Cameras Camera [1..7] Brightness DefaultLevel.....	107	Conference MaxReceiveCallRate.....	116
Cameras Camera [1..7] Brightness Mode.....	107	Conference MaxTotalReceiveCallRate.....	116
Cameras Camera [1..7] Flip.....	108	Conference MaxTotalTransmitCallRate.....	117
Cameras Camera [1..7] Focus Mode.....	108	Conference MaxTransmitCallRate.....	116
Cameras Camera [1..7] Gamma Level.....	108	Conference MicUnmuteOnDisconnect Mode.....	117
Cameras Camera [1..7] Gamma Mode.....	108	Conference Multipoint Mode.....	117
Cameras Camera [1..7] Mirror.....	109	Conference MultiStream Mode.....	117
Cameras Camera [1..7] MotorMoveDetection.....	109	Conference Presentation OnPlacedOnHold.....	118
Cameras Camera [1..7] Whitebalance Level.....	109	Conference Presentation RelayQuality.....	118
Cameras Camera [1..7] Whitebalance Mode.....	109	Conference VideoBandwidth Mode.....	118
Cameras PowerLine Frequency.....	110	<b>FacilityService settings</b> .....	<b>119</b>
Cameras PresenterTrack CameraPosition Pan.....	110	FacilityService Service [1..5] CallType.....	119
Cameras PresenterTrack CameraPosition Tilt.....	110	FacilityService Service [1..5] Name.....	119
Cameras PresenterTrack CameraPosition Zoom.....	110	FacilityService Service [1..5] Number.....	119
Cameras PresenterTrack Connector.....	110	FacilityService Service [1..5] Type.....	119
Cameras PresenterTrack Enabled.....	110	<b>GPIO settings</b> .....	<b>120</b>
Cameras PresenterTrack PresenterDetectedStatus.....	111	GPIO Pin [1..4] Mode.....	120
Cameras PresenterTrack TriggerZone.....	111	<b>H323 settings</b> .....	<b>121</b>
Cameras SpeakerTrack Closeup.....	111	H323 Authentication LoginName.....	121
Cameras SpeakerTrack ConnectorDetection CameraLeft.....	112	H323 Authentication Mode.....	121
Cameras SpeakerTrack ConnectorDetection CameraRight.....	112	H323 Authentication Password.....	121
Cameras SpeakerTrack ConnectorDetection Mode.....	112	H323 CallSetup Mode.....	121
Cameras SpeakerTrack Mode.....	111	H323 Encryption KeySize.....	122
Cameras SpeakerTrack TrackingMode.....	112	H323 Gatekeeper Address.....	122
Cameras SpeakerTrack Whiteboard Mode.....	113	H323 H323Alias E164.....	122
<b>Conference settings</b> .....	<b>114</b>	H323 H323Alias ID.....	122
Conference ActiveControl Mode.....	114	H323 NAT Address.....	123
Conference AutoAnswer Delay.....	114	H323 NAT Mode.....	122
Conference AutoAnswer Mode.....	114	H323 PortAllocation.....	123
Conference AutoAnswer Mute.....	114	<b>Logging settings</b> .....	<b>124</b>
Conference CallProtocolIPStack.....	114	Logging External Mode.....	124
Conference DefaultCall Protocol.....	115	Logging External Protocol.....	124
Conference DefaultCall Rate.....	115		
Conference DoNotDisturb DefaultTimeout.....	115		

Logging External Server Address.....	124	Network [1..1] TrafficControl Mode.....	132
Logging External Server Port.....	124	Network [1..1] VLAN Voice Mode.....	132
Logging Mode.....	124	Network [1..1] VLAN Voice VlanId.....	132
<b>Macros settings.....</b>	<b>125</b>	<b>NetworkServices settings.....</b>	<b>133</b>
Macros AutoStart.....	125	NetworkServices CDP Mode.....	133
Macros Mode.....	125	NetworkServices H323 Mode.....	133
<b>Network settings.....</b>	<b>126</b>	NetworkServices HTTP Mode.....	133
Network [1..1] DNS DNSSEC Mode.....	126	NetworkServices HTTP Proxy LoginName.....	133
Network [1..1] DNS Domain Name.....	126	NetworkServices HTTP Proxy Mode.....	134
Network [1..1] DNS Server [1..3] Address.....	126	NetworkServices HTTP Proxy PACUrl.....	134
Network [1..1] IEEE8021X AnonymousIdentity.....	127	NetworkServices HTTP Proxy Password.....	134
Network [1..1] IEEE8021X Eap Md5.....	127	NetworkServices HTTP Proxy Url.....	134
Network [1..1] IEEE8021X Eap Peap.....	128	NetworkServices HTTPS OCSP Mode.....	134
Network [1..1] IEEE8021X Eap Tls.....	128	NetworkServices HTTPS OCSP URL.....	134
Network [1..1] IEEE8021X Eap Ttls.....	127	NetworkServices HTTPS Server MinimumTLSVersion.....	135
Network [1..1] IEEE8021X Identity.....	127	NetworkServices HTTPS StrictTransportSecurity.....	135
Network [1..1] IEEE8021X Mode.....	126	NetworkServices HTTPS VerifyClientCertificate.....	135
Network [1..1] IEEE8021X Password.....	127	NetworkServices HTTPS VerifyServerCertificate.....	135
Network [1..1] IEEE8021X TlsVerify.....	126	NetworkServices NTP Mode.....	135
Network [1..1] IEEE8021X UseClientCertificate.....	127	NetworkServices NTP Server [1..3] Address.....	136
Network [1..1] IPStack.....	128	NetworkServices SIP Mode.....	136
Network [1..1] IPv4 Address.....	128	NetworkServices SNMP CommunityName.....	136
Network [1..1] IPv4 Assignment.....	128	NetworkServices SNMP Host [1..3] Address.....	136
Network [1..1] IPv4 Gateway.....	128	NetworkServices SNMP Mode.....	136
Network [1..1] IPv4 SubnetMask.....	129	NetworkServices SNMP SystemContact.....	136
Network [1..1] IPv6 Address.....	129	NetworkServices SNMP SystemLocation.....	137
Network [1..1] IPv6 Assignment.....	129	NetworkServices SSH AllowPublicKey.....	137
Network [1..1] IPv6 DHCPOptions.....	129	NetworkServices SSH HostKeyAlgorithm.....	137
Network [1..1] IPv6 Gateway.....	129	NetworkServices SSH Mode.....	137
Network [1..1] MTU.....	130	NetworkServices UPnP Mode.....	137
Network [1..1] QoS Diffserv Audio.....	130	NetworkServices UPnP Timeout.....	138
Network [1..1] QoS Diffserv Data.....	131	NetworkServices WelcomeText.....	138
Network [1..1] QoS Diffserv ICMPv6.....	131	NetworkServices Wifi Allowed.....	138
Network [1..1] QoS Diffserv NTP.....	131	NetworkServices Wifi Enabled.....	138
Network [1..1] QoS Diffserv Signalling.....	131	NetworkServices XMLAPI Mode.....	139
Network [1..1] QoS Diffserv Video.....	130	<b>Peripherals settings.....</b>	<b>140</b>
Network [1..1] QoS Mode.....	130	Peripherals InputDevice Mode.....	140
Network [1..1] RemoteAccess Allow.....	132	Peripherals Pairing CiscoTouchPanels EmcResilience.....	140
Network [1..1] Speed.....	132	Peripherals Profile Cameras.....	140



Peripherals Profile ControlSystems .....	140	Security Audit Server PortAssignment .....	151
Peripherals Profile TouchPanels .....	141	Security Session FailedLoginsLockoutTime .....	151
<b>Phonebook settings .....</b>	<b>142</b>	Security Session InactivityTimeout .....	151
Phonebook Server [1..1] ID .....	142	Security Session MaxFailedLogins .....	151
Phonebook Server [1..1] Type .....	142	Security Session MaxSessionsPerUser .....	151
Phonebook Server [1..1] URL .....	142	Security Session MaxTotalSessions .....	152
<b>Provisioning settings .....</b>	<b>143</b>	Security Session ShowLastLogon .....	152
Provisioning Connectivity .....	143	<b>SerialPort settings .....</b>	<b>153</b>
Provisioning ExternalManager Address .....	143	SerialPort BaudRate .....	153
Provisioning ExternalManager AlternateAddress .....	143	SerialPort LoginRequired .....	153
Provisioning ExternalManager Domain .....	144	SerialPort Mode .....	153
Provisioning ExternalManager Path .....	144	<b>SIP settings .....</b>	<b>154</b>
Provisioning ExternalManager Protocol .....	143	SIP ANAT .....	154
Provisioning LoginName .....	144	SIP Authentication Password .....	154
Provisioning Mode .....	144	SIP Authentication UserName .....	154
Provisioning Password .....	145	SIP DefaultTransport .....	154
<b>Proximity settings .....</b>	<b>146</b>	SIP DisplayName .....	154
Proximity Mode .....	146	SIP Ice DefaultCandidate .....	155
Proximity Services CallControl .....	146	SIP Ice Mode .....	155
Proximity Services ContentShare FromClients .....	146	SIP Line .....	155
Proximity Services ContentShare ToClients .....	146	SIP ListenPort .....	155
<b>RoomAnalytics settings .....</b>	<b>147</b>	SIP Mailbox .....	155
RoomAnalytics PeopleCountOutOfCall .....	147	SIP MinimumTLSVersion .....	156
RoomAnalytics PeoplePresenceDetector .....	147	SIP PreferredIPMedia .....	156
<b>RoomReset settings .....</b>	<b>148</b>	SIP PreferredIPSignaling .....	156
RoomReset Control .....	148	SIP Proxy [1..4] Address .....	156
<b>RTP settings .....</b>	<b>149</b>	SIP TlsVerify .....	156
RTP Ports Range Start .....	149	SIP Turn DiscoverMode .....	156
RTP Ports Range Stop .....	149	SIP Turn DropRflx .....	157
RTP Video Ports Range Start .....	149	SIP Turn Password .....	157
RTP Video Ports Range Stop .....	149	SIP Turn Server .....	157
<b>Security settings .....</b>	<b>150</b>	SIP Turn UserName .....	157
Security Audit Logging Mode .....	150	SIP Type .....	157
Security Audit OnError Action .....	150	SIP URI .....	157
Security Audit Server Address .....	150	<b>Standby settings .....</b>	<b>158</b>
Security Audit Server Port .....	151	Standby BootAction .....	158
		Standby Control .....	158
		Standby Delay .....	158

Standby StandbyAction .....	158	<b>Video settings</b> .....	<b>168</b>
Standby WakeupAction.....	158	Video ActiveSpeaker DefaultPIPPosition .....	168
Standby WakeupOnMotionDetection.....	158	Video DefaultLayoutFamily Local.....	168
<b>SystemUnit settings</b> .....	<b>159</b>	Video DefaultLayoutFamily Remote .....	169
SystemUnit CrashReporting Advanced .....	159	Video DefaultMainSource .....	169
SystemUnit CrashReporting Mode .....	159	Video Input Connector [1..5] CEC Mode .....	169
SystemUnit CrashReporting Url.....	159	Video Input Connector [1..5] HDCP Mode.....	170
SystemUnit Name .....	159	Video Input Connector [1..5] PreferredResolution.....	171
<b>Time settings</b> .....	<b>160</b>	Video Input Connector [1..5] RGBQuantizationRange .....	172
Time DateFormat .....	160	Video Input Connector [1..6] CameraControl Camerald .....	169
Time TimeFormat.....	160	Video Input Connector [1..6] CameraControl Mode.....	169
Time Zone.....	161	Video Input Connector [1..6] InputSourceType.....	170
<b>UserInterface settings</b> .....	<b>163</b>	Video Input Connector [1..6] Name .....	170
UserInterface Accessibility IncomingCallNotification .....	163	Video Input Connector [1..6] OptimalDefinition Profile .....	170
UserInterface ContactInfo Type .....	163	Video Input Connector [1..6] PresentationSelection .....	171
UserInterface CustomMessage .....	163	Video Input Connector [1..6] Quality .....	172
UserInterface KeyTones Mode.....	164	Video Input Connector [1..6] Visibility.....	172
UserInterface Language .....	164	Video Input Connector [6] OptimalDefinition Threshold60fps .....	170
UserInterface OSD EncryptionIndicator.....	164	Video Monitors.....	173
UserInterface OSD HalfwakeMessage .....	164	Video Output Connector [1..3] CEC Mode .....	173
UserInterface OSD Output.....	165	Video Output Connector [1..3] Location HorizontalOffset.....	174
UserInterface Security Mode.....	165	Video Output Connector [1..3] Location VerticalOffset.....	174
UserInterface SettingsMenu Mode.....	165	Video Output Connector [1..3] MonitorRole .....	175
UserInterface Wallpaper .....	165	Video Output Connector [1..3] Resolution.....	175
<b>UserManagement settings</b> .....	<b>166</b>	Video Output Connector [1..3] RGBQuantizationRange .....	176
UserManagement LDAP Admin Filter .....	166	Video Presentation DefaultPIPPosition .....	176
UserManagement LDAP Admin Group .....	166	Video Presentation DefaultSource.....	176
UserManagement LDAP Attribute.....	166	Video Selfview Default FullscreenMode .....	176
UserManagement LDAP BaseDN .....	166	Video Selfview Default Mode.....	177
UserManagement LDAP Encryption .....	166	Video Selfview Default OnMonitorRole.....	177
UserManagement LDAP MinimumTLSVersion.....	167	Video Selfview Default PIPPosition.....	177
UserManagement LDAP Mode .....	167	Video Selfview OnCall Duration .....	178
UserManagement LDAP Server Address .....	167	Video Selfview OnCall Mode .....	177
UserManagement LDAP Server Port.....	167	<b>Experimental settings</b> .....	<b>179</b>
UserManagement LDAP VerifyServerCertificate.....	167		

## Audio settings

### Audio DefaultVolume

Define the default volume for the speakers. The volume is set to this value when you switch on or restart the video system. Use the controls on the user interface to change the volume while it is running. You may also use API commands (xCommand Audio Volume) to change the volume while the video system is running, and to reset to default value.

Requires user role: ADMIN, INTEGRATOR, USER

Default value: 50

Value space: Integer (0..100)

Range: Select a value between 1 and 100. This corresponds to the dB range from -34.5 dB to 15 dB, in steps of 0.5 dB. If set to 0 the audio is switched off.

### Audio Input ARC [1..3] Mode

The ARC (Audio Return Channel) is an HDMI feature that lets you have an audio channel from external TVs. Define if the ARC channel on the HDMI output connector shall be enabled.

Requires user role: ADMIN, INTEGRATOR

Default value: On

Value space: Off/On

Off: Disable ARC channel on the HDMI output.

On: Enable ARC channel on the HDMI output.

### Audio Input HDMI [1..5] Level

Set the gain on the HDMI input connector. The gain can be tuned in steps of 1 dB.

Requires user role: ADMIN, INTEGRATOR

Default value: 0

Value space: Integer (-24..0)

Range: Select the gain in decibel (dB).

### Audio Input HDMI [1..5] Mode

Define if the audio on the HDMI input connector shall be enabled.

Requires user role: ADMIN, INTEGRATOR

Default value: On

Value space: Off/On

Off: Disable audio on the HDMI input.

On: Enable audio on the HDMI input.

### Audio Input HDMI [1..5] VideoAssociation MuteOnInactiveVideo

Use this setting to decide whether to stop the audio playback of a connected presentation source if that presentation source is not currently shown on-screen, or to always playback the audio as long as the presentation source is connected.

Requires user role: ADMIN, INTEGRATOR

Default value: HDMI[1-2]: Off HDMI[3-5]: On

Value space: Off/On

Off: Audio is played, locally and to far end, as long as a presentation source is connected; you do not have to present the HDMI input source.

On: Audio is played, locally and to far end, only when the connected presentation source is shown on-screen.

## Audio Input Microphone [1..8] EchoControl Mode

The echo canceller continuously adjusts itself to the audio characteristics of the room, and compensates for any changes it detects in the audio environment. If the changes in the audio conditions are significant, the echo canceller may take a second or two to re-adjust.

Requires user role: ADMIN, INTEGRATOR

Default value: On

Value space: Off/On

Off: Turn off the echo control. Recommended if external echo cancellation or playback equipment is used.

On: Turn on the echo control. Recommended, in general, to prevent the far end from hearing their own audio. Once selected, echo cancellation is active at all times.

## Audio Input Microphone [1..8] EchoControl Dereverberation

The system has built-in signal processing to reduce the effect of room reverberation. Dereverberation requires that Audio Input Microphone [n] EchoControl Mode is enabled.

Requires user role: ADMIN, INTEGRATOR

Default value: Off

Value space: Off/On

Off: Turn off the dereverberation.

On: Turn on the dereverberation.

## Audio Input Microphone [1..8] EchoControl NoiseReduction

The system has built-in noise reduction, which reduces stationary background noise, for example noise from air-conditioning systems, cooling fans etc. In addition, a high pass filter (Humfilter) reduces very low frequency noise. Noise reduction requires that Audio Input Microphone [n] EchoControl Mode is enabled.

Requires user role: ADMIN, INTEGRATOR

Default value: On

Value space: Off/On

Off: Turn off the noise reduction.

On: Turn on the noise reduction. Recommended in the presence of low frequency noise.

## Audio Input Microphone [1..8] Equalizer ID

Select the equalizer ID of the source that is connected to the microphone input.

Requires user role: ADMIN, INTEGRATOR

Default value: 1

Value space: Integer (1..8)

Set the equalizer ID.

## Audio Input Microphone [1..8] Equalizer Mode

Define the equalizer mode for the source that is connected to the microphone input.

Requires user role: ADMIN, INTEGRATOR

Default value: Off

Value space: Off/On

Off: No equalizer.

On: Enable the equalizer for the source that is connected to the microphone input.

## Audio Input Microphone [1..8] Level

Set the gain on the Microphone input connector. The gain should be adjusted to suit the output level of the connected audio source. The gain can be tuned in steps of 1 dB.

If the gain is set too high, the audio signal will be clipped. If the gain is set too low, the audio signal-to-noise ratio will be degraded; however, this is usually preferable to clipping.

Note that unprocessed speech signals typically contain significant level variations, making it very important to allow for sufficient signal headroom.

The maximum input level with 0 dB gain, is 24 dBu.

Example: If your microphone has a maximum output level of -44 dBu, then you should set the gain to 24 dBu - (-44 dBu) = 68 dB.

Requires user role: ADMIN, INTEGRATOR

Default value: 58

Value space: Integer (0..70)

Range: Select the gain in decibel (dB).

## Audio Input Microphone [1..8] Mode

Disable or enable audio on the microphone connector.

Requires user role: ADMIN, INTEGRATOR

Default value: On

Value space: Off/On

Off: Disable the audio input microphone connector.

On: Enable the audio input microphone connector.

## Audio Input Microphone [1..8] PhantomPower

Define whether or not to have phantom power (48 V +/- 1 V) on the microphone input.

Requires user role: ADMIN, INTEGRATOR

Default value: On

Value space: Off/On

Off: Disable the phantom power on the microphone input. Use this when connecting to equipment that do not need phantom power, such as external mixers.

On: Enable the phantom power on the microphone input. Use this when connecting directly to microphones that require phantom power, including the Cisco Table Microphone and Cisco Ceiling Microphone.

## Audio Input Microphone [1..8] VideoAssociation MuteOnInactiveVideo

The microphone can be associated with a video source on the video input connector, and you can determine whether to play or mute audio depending on whether the video source is presented or not. By default, audio is not muted.

Requires user role: ADMIN, INTEGRATOR

Default value: On

Value space: Off/On

Off: No video source is associated.

On: A video source is associated, and the audio will be muted if the associated video source is not displayed.

## Audio Input Microphone [1..8] VideoAssociation VideoInputSource

Select the video input connector to associate the audio source with.

Requires user role: ADMIN, INTEGRATOR

Default value: 1

Value space: 1/2/3/4/5

Select the video input connector to associate the audio source with.

## Audio KeyClickDetector Attenuate

The video system (codec) can detect clicking noise from a keyboard and automatically attenuate the microphone signal. This is useful when a meeting participant starts typing on the keyboard, because the noise can disturb the other participants. If the participant types on the keyboard and speaks at the same time the microphone signal will not be attenuated. Requires that the Audio KeyClickDetector Enabled setting is set to On.

Requires user role: ADMIN, INTEGRATOR, USER

Default value: On

Value space: Off/On

Off: The attenuation of the microphone signal is disabled.

On: The system will attenuate the microphone signal if clicking noise from keyboards is detected. If voice or voice + keyboard clicks are detected the microphone signal will not be attenuated.

## Audio KeyClickDetector Enabled

The video system (codec) can detect clicking noise from a keyboard and automatically attenuate the microphone signal. This is useful when a meeting participant starts typing on the keyboard, because the noise can disturb other participants. To enable attenuation on the microphone signal, set the Audio KeyClickDetector Attenuate to On.

Requires user role: ADMIN, INTEGRATOR, USER

Default value: Off

Value space: Off/On

Off: The key click detection is disabled.

On: The system will detect clicking noise from keyboards.

## Audio Microphones Mute Enabled

Define the microphone mute behavior on the video system.

Requires user role: ADMIN, INTEGRATOR

Default value: True

Value space: True/InCallOnly

True: Muting of audio is always available.

InCallOnly: Muting of audio is only available when the device is in a call. When Idle it is not possible to mute the microphone. This is useful when an external telephone service/ audio system is connected via the codec and is to be available when the codec is not in a call. When set to InCallOnly this will prevent the audio-system from being muted by mistake.

## Audio Output ARC [1..1] Delay DelayMs

To obtain lip-synchronization, you can configure each ARC output with an extra delay that compensates for delay in other connected devices, for example TVs and external loudspeakers. The delay that you set here is either fixed or relative to the delay measured on or reported by an external monitor, as defined in the Audio Output ARC [n] Delay Mode setting.

Requires user role: ADMIN, INTEGRATOR

Default value: 0

Value space: Integer (0..290)

The delay in milliseconds.

## Audio Output ARC [1..1] Delay Mode

You may add extra delay to an audio ARC output with the Audio Output ARC [n] Delay DelayMs setting. The extra delay added is either a fixed number of milliseconds, or a number of milliseconds relative to the detected delay on or reported by an external monitor.

Requires user role: ADMIN, INTEGRATOR

Default value: RelativeToHDMI

Value space: Fixed/RelativeToHDMI

Fixed: Any extra delay (DelayMs) added to the output, will be a fixed number of millisecond.

RelativeToHDMI: Any extra delay (DelayMs) added to the output, will be relative to the detected delay on or reported by an external monitor. The actual delay is detected-delay + DelayMs. The Audio Output Connectors ARC [n] DelayMs status reports the actual delay.

## Audio Output ARC [1..1] Mode

Use for audio playback on the Quad Camera. Define if the ARC channel on the HDMI input connector shall be enabled.

Requires user role: ADMIN, INTEGRATOR

Default value: Auto

Value space: Auto/Off/On

Auto: The ARC channel is enabled on the HDMI input.

Off: Disable ARC channel on the HDMI input.

On: Enable ARC channel on the HDMI input.

## Audio Output HDMI [1..3] Delay DelayMs

To obtain lip-synchronization, you can configure each HDMI output with an extra delay that compensates for delay in other connected devices, for example TVs and external loudspeakers. The delay that you set here is either fixed or relative to the delay measured on or reported by an external monitor, as defined in the Audio Output HDMI [n] Delay Mode setting.

Requires user role: ADMIN, INTEGRATOR

Default value: 0

Value space: Integer (0..290)

The delay in milliseconds.

## Audio Output HDMI [1..3] Delay Mode

You may add extra delay to an audio hdmi output with the Audio Output HDMI [n] Delay DelayMs setting. The extra delay added is either a fixed number of milliseconds, or a number of milliseconds relative to the detected delay on or reported by an external monitor.

Requires user role: ADMIN, INTEGRATOR

Default value: Fixed

Value space: Fixed/RelativeToHDMI

Fixed: Any extra delay (DelayMs) added to the output, will be a fixed number of millisecond.

RelativeToHDMI: Any extra delay (DelayMs) added to the output, will be relative to the detected delay on or reported by an external monitor. The actual delay is detected-delay + DelayMs. The Audio Output Connectors HDMI [n] DelayMs status reports the actual delay.

## Audio Output HDMI [1..3] Mode

Define if the audio channel on the HDMI output connector shall be enabled.

Requires user role: ADMIN, INTEGRATOR

Default value: Auto

Value space: Auto/Off/On

Auto: If all connectors are set to Auto and a Quad Camera is in use, the audio will be played on the camera. If, in addition, one or more screens are connected to the codec, the audio will be played on the camera, and the system will measure the delay on the first available screen that is connected to HDMI output 1, 2 or 3. The codec sends a signal to the screen and the screen sends the signal back on the Audio Return Channel (ARC). This delay measurement is used to synchronize the audio on the camera with the video on screen (lip-synch). Consumer Electronics Control (CEC) is used for the screen to use ARC.

If all connectors are set to Auto and no Quad Camera is connected, the system will try HDMI 1, then HDMI 2, and finally HDMI 3 and play the audio on the first available screen. No additional lip-synchronization delay will be automatically added by the codec, instead this responsibility falls on the screen on which the audio is played out.

Requirements for the Auto setting: The camera control (Ethernet) from the Quad Camera must be connected to LAN through one of the codecs camera control connectors (Ethernet 2 or 3). The cameras HDMI output must be connected to the codecs camera input (HDMI 1), which is the ARC (Audio Return Channel) output connector, and the corresponding Video Input Connector [n] CEC Mode must be set to On. Audio Output InternalSpeaker Mode must be set to On and Audio Output ARC (1) Mode must be set to On or Auto.

Off: The connector will not be used for audio out and no delay measurement will be performed.

On: The connector will be used for audio out.

## Audio Output Line [1..6] Channel

Define whether the Audio Line output is a mono signal or part of a multichannel signal.

Requires user role: ADMIN, INTEGRATOR

Default value: Line[1,3,5]: Left Line[2,4,6]: Right

Value space: Left/Mono/Right

Left: The Audio Line output signal is the left channel of a stereo signal.

Mono: The Audio Line output signal is a mono signal.

Right: The Audio Line output signal is the right channel of a stereo signal.

## Audio Output Line [1..6] Delay DelayMs

To obtain lip-synchronization, you can configure each audio line output with an extra delay that compensates for delay in other connected devices, for example TVs and external loudspeakers. The delay that you set here is either fixed or relative to the delay on the HDMI output, as defined in the Audio Output Line [n] Delay Mode setting.

Requires user role: ADMIN, INTEGRATOR

Default value: 0

Value space: Integer (0..290)

The delay in milliseconds.

## Audio Output Line [1..6] Delay Mode

You may add extra delay to an audio line output with the Audio Output Line [n] Delay DelayMs setting. The extra delay added is either a fixed number of milliseconds, or a number of milliseconds relative to the detected delay on the HDMI output (typically introduced by the connected TV).

Requires user role: ADMIN, INTEGRATOR

Default value: RelativeToHDMI

Value space: Fixed/RelativeToHDMI

Fixed: Any extra delay (DelayMs) added to the output, will be a fixed number of millisecond.

RelativeToHDMI: Any extra delay (DelayMs) added to the output, will be relative to the detected delay on the HDMI output. The actual delay is HDMI-delay + DelayMs. The Audio Output Connectors Line [n] DelayMs status reports the actual delay.

## Audio Output Line [1..6] Equalizer ID

Select the equalizer ID for the audio source that is connected to the output line.

Requires user role: ADMIN, INTEGRATOR

Default value: 1

Value space: Integer (1..8)

Set the equalizer ID.

## Audio Output Line [1..6] Equalizer Mode

Define the equalizer mode for the audio source that is connected to the output line.

Requires user role: ADMIN, INTEGRATOR

Default value: Off

Value space: Off/On

Off: No equalizer.

On: Enable the equalizer for the audio output line.

## Audio Output Line [1..6] Level

Set the gain on the Line output connector. The gain should be adjusted to fit the audio input level of the connected device. The gain can be tuned in steps of 1 dB.

The maximum output level with 0 dB gain is 18 dBu.

Example: If he connected audio device has max input level 10 dBu, then you should set the gain to 10 dBu - 18 dBu = -8 dB.

Requires user role: ADMIN, INTEGRATOR

Default value: 0

Value space: Integer (-24..0)

Range: Select the gain in decibel (dB).

## Audio Output Line [1..6] Mode

Define the mode for the audio line output.

Requires user role: ADMIN, INTEGRATOR

Default value: On

Value space: Off/On

Off: Disable the audio line output.

On: Enable the audio line output.



## Audio SoundsAndAlerts RingTone

Define which ringtone to use for incoming calls.

Requires user role: ADMIN, INTEGRATOR, USER

Default value: Sunrise

Value space: Sunrise/Mischief/Ripples/Reflections/Vibes/Delight/Evolve/Playful/Ascent/Calculation/Mellow/Ringer

Select a ringtone from the list.

## Audio SoundsAndAlerts RingVolume

Define the ring volume for incoming calls.

Requires user role: ADMIN, INTEGRATOR, USER

Default value: 50

Value space: Integer (0..100)

Range: The value goes in steps of 5 from 0 to 100 (from -34.5 dB to 15 dB). Volume 0 = Off.

## Audio Ultrasound Mode

This setting applies to the Intelligent Proximity feature. Keep the setting at its default value.

Requires user role: ADMIN, INTEGRATOR

Default value: Dynamic

Value space: Dynamic/Static

Dynamic: The video system adjusts the ultrasound volume dynamically. The volume may vary up to the maximum level as defined in the Audio Ultrasound Volume MaxVolume setting.

Static: Use only if advised by Cisco.

## Audio Ultrasound MaxVolume

This setting applies to the Intelligent Proximity feature. Set the maximum volume of the ultrasound pairing message.

Requires user role: ADMIN, INTEGRATOR

Default value: 60

Value space: Integer (0..90)

Select a value in the specified range. If set to 0, the ultrasound is switched off.

## CallHistory settings

### CallHistory Mode

Determine whether or not information about calls that are placed or received are stored, including missed calls and calls that are not answered (call history). This determines whether or not the calls appear in the Recents list in the user interfaces.

Requires user role: ADMIN, INTEGRATOR

Default value: On

Value space: Off/On

Off: New entries are not added to the call history.

On: New entries are stored in the call history list.

## Cameras settings

### Cameras Camera [1..7] AssignedSerialNumber

The camera ID is the number *n* in Camera [*n*]. By default, the camera ID is assigned automatically to a camera. If EDID information is not passed on from the camera to the codec, the camera ID is not persistent after a reboot. This means that a camera may get a new camera ID when the codec (video system) is restarted.

You should use the Cameras Camera AssignedSerialNumber setting to cater for configurations where the codec does not receive EDID information from multiple cameras. This setting allows you to manually assign a camera ID to a camera by associating the camera ID with the camera's serial number. The setting is persistent until the codec is factory reset.

Typical situations where the codec does not receive EDID information are: when you connect a Cisco TelePresence Precision 60 camera using 3G-SDI, or when you use an HDMI repeater that does not pass on EDID information.

Requires user role: ADMIN, INTEGRATOR

Default value: ""

Value space: String (0, 20)

The camera's serial number.

### Cameras Camera [1..7] Backlight DefaultMode

This configuration turns backlight compensation on or off. Backlight compensation is useful when there is much light behind the persons in the room. Without compensation the persons will easily appear very dark to the far end.

Not applicable if you have a Cisco Quad Camera, because this camera automatically adjusts itself based on the room lighting conditions.

Requires user role: ADMIN, INTEGRATOR

Default value: Off

Value space: Off/On

Off: Turn off the camera backlight compensation.

On: Turn on the camera backlight compensation.

### Cameras Camera [1..7] Brightness Mode

Define the camera brightness mode.

Not applicable if you have a Cisco Quad Camera, because this camera automatically adjusts itself based on the room lighting conditions.

Requires user role: ADMIN, INTEGRATOR

Default value: Auto

Value space: Auto/Manual

Auto: The camera brightness is automatically set by the system.

Manual: Enable manual control of the camera brightness. The brightness level is set using the Cameras Camera [*n*] Brightness DefaultLevel setting.

### Cameras Camera [1..7] Brightness DefaultLevel

Define the brightness level. Requires the Cameras Camera [*n*] Brightness Mode to be set to Manual.

Not applicable if you have a Cisco Quad Camera, because this camera automatically adjusts itself based on the room lighting conditions.

Requires user role: ADMIN, INTEGRATOR

Default value: 20

Value space: Integer (1..31)

The brightness level.

## Cameras Camera [1..7] Flip

With Flip mode (vertical flip) you can flip the image upside down. Flipping applies both to the self-view and the video that is transmitted to the far end.

Requires user role: ADMIN, INTEGRATOR

Default value: Auto

Value space: Auto/Off/On

Auto: If the camera detects that it is mounted upside down, the image is automatically flipped. If the camera cannot auto-detect whether it is mounted upside down or not, the image is not changed.

Off: Display the image on screen the normal way.

On: Display the image flipped upside down. This setting is used when a camera is mounted upside down, but cannot automatically detect which way it is mounted.

## Cameras Camera [1..7] Focus Mode

Define the camera focus mode.

Requires user role: ADMIN, INTEGRATOR

Default value: Auto

Value space: Auto/Manual

Auto: Cisco TelePresence Precision 60 camera: The camera will do continuous auto focusing. It will, more specifically, run auto focus once a call is connected, after pan, tilt, zoom have changed, and generally when the camera identifies a change in the scene.

Auto: Cisco Quad Camera: The camera will do single shot auto focusing once a call is connected and when the view has changed.

Manual: Turn the autofocus off and adjust the camera focus manually.

## Cameras Camera [1..7] Gamma Mode

This setting enables gamma corrections. Gamma describes the nonlinear relationship between image pixels and monitor brightness.

Not applicable if you have a Cisco Quad Camera, because this camera automatically adjusts itself based on the room lighting conditions.

Requires user role: ADMIN, INTEGRATOR

Default value: Auto

Value space: Auto/Manual

Auto: Auto is the default and the recommended setting.

Manual: In manual mode the gamma value is changed with the gamma level setting, ref. Cameras Camera [n] Gamma Level.

## Cameras Camera [1..7] Gamma Level

By setting the Gamma Level you can select which gamma correction table to use. This setting may be useful in difficult lighting conditions, where changes to the brightness setting does not provide satisfactory results. Requires the Cameras Camera [n] Gamma Mode to be set to Manual.

Not applicable if you have a Cisco Quad Camera, because this camera automatically adjusts itself based on the room lighting conditions.

Requires user role: ADMIN, INTEGRATOR

Default value: 0

Value space: Integer (0..7)

Define the gamma level.

## Cameras Camera [1..7] Mirror

With Mirror mode (horizontal flip) you can mirror the image on screen. Mirroring applies both to the self-view and the video that is transmitted to the far end. This setting is not applicable when your video system has a Cisco Quad Camera or while speaker tracking is on.

Requires user role: ADMIN, INTEGRATOR

Default value: Auto

Value space: Auto/Off/On

Auto: If the camera detects that it is mounted upside down, the image is automatically mirrored. If the camera cannot auto-detect whether it is mounted upside down or not, the image is not changed.

Off: Display the image as other people see you.

On: Display the image as you see yourself in a mirror.

## Cameras Camera [1..7] MotorMoveDetection

This setting applies only when using a Cisco TelePresence PrecisionHD 1080p12x camera.

If adjusting the camera position by hand you can configure whether the camera should keep its new position or return to the preset or position it had before.

Requires user role: ADMIN, INTEGRATOR

Default value: Off

Value space: Off/On

Off: When the camera position is adjusted manually the camera will keep this position until adjusted again. **WARNING:** If you manually tilt the camera, the camera will not register the new pan and tilt values since there is no position feedback. This will result in wrong pan and tilt values when recalling the camera presets subsequently.

On: When the camera position is adjusted manually, or the camera detects that the motors have moved, it will first re-initialize (i.e. go to default position) then return to the preset/position it had before the camera was adjusted.

## Cameras Camera [1..7] Whitebalance Mode

Define the camera white balance mode.

Not applicable if you have a Cisco Quad Camera, because this camera automatically adjusts itself based on the room lighting conditions.

Requires user role: ADMIN, INTEGRATOR

Default value: Auto

Value space: Auto/Manual

Auto: The camera will continuously adjust the white balance depending on the camera view.

Manual: Enables manual control of the camera white balance. The white balance level is set using the Cameras Camera [n] Whitebalance Level setting.

## Cameras Camera [1..7] Whitebalance Level

Define the white balance level. Requires the Cameras Camera [n] Whitebalance Mode to be set to manual.

Not applicable if you have a Cisco Quad Camera, because this camera automatically adjusts itself based on the room lighting conditions.

Requires user role: ADMIN, INTEGRATOR

Default value: 1

Value space: Integer (1..16)

The white balance level.

## Cameras PowerLine Frequency

If your camera supports power line frequency anti-flickering, the camera is able to compensate for any flicker noise from the electrical power supply. You should set this camera configuration based on your power line frequency. If your camera supports auto detection of line frequency, you can select the Auto option in the configuration.

All Cisco Precision cameras support both anti-flickering and auto detection of line frequency. Auto is the default value, so you should change this setting if you have a camera that does not support auto detection.

Requires user role: ADMIN, INTEGRATOR

Default value: Auto

Value space: 50Hz/60Hz/Auto

50Hz: Use this value when the power line frequency is 50 Hz.

60Hz: Use this value when the power line frequency is 60 Hz.

Auto: Allow the camera to detect the power frequency automatically.

## Cameras PresenterTrack CameraPosition Pan

Define the pan position that the presenter tracking camera will move to when the feature is activated. Only the Precision 60 and SpeakerTrack 60 cameras support presenter tracking.

Requires user role: ADMIN, INTEGRATOR

Default value: 0

Value space: Integer (-65535..65535)

The pan position.

## Cameras PresenterTrack CameraPosition Tilt

Define the tilt position that the presenter tracking camera will move to when the feature is activated. Only the Precision 60 and SpeakerTrack 60 cameras support presenter tracking.

Requires user role: ADMIN, INTEGRATOR

Default value: 0

Value space: Integer (-65535..65535)

The tilt position.

## Cameras PresenterTrack CameraPosition Zoom

Define the zoom position that the presenter tracking camera will move to when the feature is activated. Only the Precision 60 and SpeakerTrack 60 cameras support presenter tracking.

Requires user role: ADMIN, INTEGRATOR

Default value: 0

Value space: Integer (-65535..65535)

The zoom position.

## Cameras PresenterTrack Connector

Define which video input connector the presenter tracking camera is connected to. Only the Precision 60 and SpeakerTrack 60 cameras support presenter tracking.

Requires user role: ADMIN, INTEGRATOR

Default value: 6

Value space: Integer (1..6)

The video input connector.

## Cameras PresenterTrack Enabled

Define whether or not the PresenterTrack feature is available for use. Only the Precision 60 and SpeakerTrack 60 cameras support presenter tracking.

Requires user role: ADMIN, INTEGRATOR

Default value: False

Value space: False/True

False: The PresenterTrack feature is disabled.

True: The PresenterTrack feature is available for use.

## Cameras PresenterTrack PresenterDetectedStatus

Define whether to enable or disable automatic switching between the Remote Presenter and Local Presenter modes in the Briefing room and Classroom scenarios (Room Type templates). Automatic switching implies that the system switches to Local Presenter mode when a person is detected in the PresenterTrack trigger zone, and that the system switches back to the Remote Presenter mode when the local presenter leaves the stage.

If this setting is enabled, the Cameras PresenterTrack PresenterDetected status will be updated when a new person enters the trigger zone.

Only the Precision 60 and SpeakerTrack 60 cameras support presenter tracking.

Requires user role: ADMIN, INTEGRATOR

Default value: Enabled

Value space: Disabled/Enabled

Disabled: No automatic switching between modes.

Enabled: Automatic switching between the Local Presenter and Remote Presenter modes.

## Cameras PresenterTrack TriggerZone

Define the trigger zone, which corresponds to the area where a person's face must be detected for presenter tracking to start.

The format is a string of x and y coordinate pairs: "x1,y1,...xn,yn", where the range of x is (0,1920) and y is (0,1080). Two coordinate pairs define the upper left and lower right corner of a rectangular trigger zone. More than two coordinate pairs define the vertices of a polygonal trigger zone.

Only the Precision 60 and SpeakerTrack 60 cameras support presenter tracking.

Requires user role: ADMIN, INTEGRATOR

Default value: ""

Value space: String (0..255)

The coordinates for the trigger zone.

## Cameras SpeakerTrack Mode

This setting applies only when using a camera with support for speaker tracking.

For systems with a Cisco Quad Camera: Speaker tracking uses automatic camera framing to select the best camera view based on how many people are in the room. The Quad Camera consists of two cameras and uses an audio tracking technique that finds and captures a close-up of the active speaker.

For systems with a Cisco TelePresence SpeakerTrack 60 Camera: The dual camera assembly consists of two cameras and uses an audio tracking technique that finds and captures a close-up of the active speaker. When a change of speaker is detected, the system can switch automatically between the two cameras to always show the best camera view. Refer to the Cameras SpeakerTrack TrackingMode setting for different switching modes.

Requires user role: ADMIN, INTEGRATOR

Default value: Auto

Value space: Auto/Off

Auto: Speaker tracking is switched on. The system will detect people in the room and automatically select the best camera framing. Users can switch speaker track on or off instantly in the camera control panel on the Touch controller.

Off: Speaker tracking is switched off. If you have a Cisco TelePresence SpeakerTrack 60 Camera the two cameras operate as individual cameras.

## Cameras SpeakerTrack Closeup

This setting applies only when the Cameras SpeakerTrack Mode is set to Auto.

When a person in the room speaks the system will find the person and select the best camera framing. This is called a closeup and may not include all the persons in the room. If you want all the persons in the room to be in the picture at all times you can turn off the closeup functionality.

Requires user role: ADMIN, INTEGRATOR, USER

Default value: Auto

Value space: Auto/Off

Auto: The system will zoom in on the person speaking.

Off: The system will keep all the persons in the room in the camera framing at all times.

## Cameras SpeakerTrack TrackingMode

This setting applies only when using a Cisco TelePresence SpeakerTrack 60 camera, and when Cameras SpeakerTrack Mode is set to Auto.

The speaker tracking algorithm can react to changes in two modes, one faster than the other. The mode determines when the camera view will change to a new speaker.

Requires user role: ADMIN, INTEGRATOR

Default value: Auto

Value space: Auto/Conservative

Auto: This is the normal tracking mode.

Conservative: The camera view will change to a new speaker later than in normal tracking mode.

## Cameras SpeakerTrack ConnectorDetection Mode

This setting applies only when a Cisco TelePresence SpeakerTrack 60 camera is connected to the codec (video system).

Define whether to automatically detect or manually configure which video input each individual camera is connected to. You should choose manual configuration in situations where the codec does not receive EDID information from the cameras. Typically, this will be when you use HDMI repeaters that do not pass on EDID information.

Requires user role: ADMIN, INTEGRATOR

Default value: Auto

Value space: Auto/Manual

Auto: Automatically detect which video inputs the cameras are connected to.

Manual: Manually define which video inputs the cameras are connected to. Use the Cameras SpeakerTrack ConnectorDetection CameraLeft and Cameras SpeakerTrack ConnectorDetection CameraRight settings.

## Cameras SpeakerTrack ConnectorDetection CameraLeft

Define the number of the video input that SpeakerTrack 60's left camera is connected to.

This setting applies only when a Cisco TelePresence SpeakerTrack 60 camera is connected to the codec (video system). Furthermore, Cameras SpeakerTrack ConnectorDetection Mode must be set to Manual.

Requires user role: ADMIN, INTEGRATOR

Default value: 1

Value space: Integer (1..5)

Set a valid video input number. For example, set to 1 if the left camera is connected to video input 1.

## Cameras SpeakerTrack ConnectorDetection CameraRight

Define the number of the video input that SpeakerTrack 60's right camera is connected to.

This setting applies only when a Cisco TelePresence SpeakerTrack 60 camera is connected to the codec (video system). Furthermore, Cameras SpeakerTrack ConnectorDetection Mode must be set to Manual.

Requires user role: ADMIN, INTEGRATOR

Default value: 2

Value space: Integer (1..5)

Set a valid video input number. For example, set to 2 if the right camera is connected to video input 2.



## Cameras SpeakerTrack Whiteboard Mode

This setting applies only when using a camera with support for speaker tracking.

The Snap to Whiteboard feature extends the speaker tracking functionality, thus you need a camera that supports speaker tracking. When a presenter is standing next to the whiteboard, the camera will capture both the presenter and the whiteboard if the Snap to Whiteboard feature is enabled. If the feature is disabled, only the presenter will be captured. The Snap to Whiteboard feature is set up from the Touch controller or web interface.

Requires user role: ADMIN, INTEGRATOR, USER

Default value: Off

Value space: Off/On

Off: The Snap to Whiteboard feature is disabled.

On: The Snap to Whiteboard feature is enabled.

## Conference settings

### Conference ActiveControl Mode

Active control is a feature that allows conference participants to administer a conference on Cisco TelePresence Server or Cisco Meeting Server using the video system's interfaces. Each user can see the participant list, change video layout, disconnect participants, etc. from the interface. The active control feature is enabled by default, provided that it is supported by the infrastructure (Cisco Unified Communications Manager (CUCM) version 9.1.2 or newer, Cisco TelePresence Video Communication Server (VCS) version X8.1 or newer, Cisco Media Server (CMS) version 2.1 or newer). Change this setting if you want to disable the active control features.

Requires user role: ADMIN

Default value: Auto

Value space: Auto/Off

Auto: Active control is enabled when supported by the infrastructure.

Off: Active control is disabled.

### Conference AutoAnswer Mode

Define the auto answer mode. Use the Conference AutoAnswer Delay setting if you want the system to wait a number of seconds before answering the call, and use the Conference AutoAnswer Mute setting if you want your microphone to be muted when the call is answered.

Requires user role: ADMIN

Default value: Off

Value space: Off/On

Off: You can answer incoming calls manually by tapping Answer on the Touch controller.

On: The system automatically answers incoming calls, except if you are already in a call. You can answer or decline incoming calls manually when you are already engaged in a call.

### Conference AutoAnswer Mute

Define if the microphone shall be muted when an incoming call is automatically answered. Requires that AutoAnswer Mode is switched on.

Requires user role: ADMIN

Default value: Off

Value space: Off/On

Off: The incoming call will not be muted.

On: The incoming call will be muted when automatically answered.

### Conference AutoAnswer Delay

Define how long (in seconds) an incoming call has to wait before it is answered automatically by the system. Requires that AutoAnswer Mode is switched on.

Requires user role: ADMIN

Default value: 0

Value space: Integer (0..50)

The auto answer delay (seconds).

### Conference CallProtocolIPStack

Select if the system should enable IPv4, IPv6, or dual IP stack on the call protocol (SIP, H323).

Requires user role: ADMIN

Default value: Dual

Value space: Dual/IPv4/IPv6

Dual: Enables both IPv4 and IPv6 for the call protocol.

IPv4: When set to IPv4, the call protocol will use IPv4.

IPv6: When set to IPv6, the call protocol will use IPv6.

## Conference DefaultCall Protocol

Define the Default Call Protocol to be used when placing calls from the system.

Requires user role: ADMIN

Default value: Auto

Value space: Auto/H320/H323/Sip/Spark

Auto: Enables auto-selection of the call protocol based on which protocols are available. If multiple protocols are available, the order of priority is: 1) SIP; 2) H323; 3) H320. If the system cannot register, the auto-selection chooses H323.

H320: All calls are set up as H.320 calls (only applicable if used with Cisco TelePresence ISDN Link).

H323: All calls are set up as H.323 calls.

Sip: All calls are set up as SIP calls.

Spark: Reserved for Webex registered systems. Do not use.

## Conference DefaultCall Rate

Define the Default Call Rate to be used when placing calls from the system.

Requires user role: ADMIN, INTEGRATOR

Default value: 6000

Value space: Integer (64..6000)

The default call rate (kbps).

## Conference DoNotDisturb DefaultTimeout

This setting determines the default duration of a Do Not Disturb session, i.e. the period when incoming calls are rejected and registered as missed calls. The session can be terminated earlier by using the user interface.

Requires user role: ADMIN, INTEGRATOR

Default value: 60

Value space: Integer (1..1440)

The number of minutes (maximum 1440 minutes = 24 hours) before the Do Not Disturb session times out automatically.

## Conference Encryption Mode

Define the conference encryption mode. A padlock with the text "Encryption On" or "Encryption Off" displays on screen for a few seconds when the conference starts.

NOTE: If the Encryption Option Key is not installed on the video system, the encryption mode is always Off.

Requires user role: ADMIN

Default value: BestEffort

Value space: Off/On/BestEffort

Off: The system will not use encryption.

On: The system will only allow calls that are encrypted.

BestEffort: The system will use encryption whenever possible.

> In Point to point calls: If the far end system supports encryption (AES-128), the call will be encrypted. If not, the call will proceed without encryption.

> In MultiSite calls: In order to have encrypted MultiSite conferences, all sites must support encryption. If not, the conference will be unencrypted.

## Conference FarEndControl Mode

Lets you decide if the remote side (far end) should be allowed to select your video sources and control your local camera (pan, tilt, zoom).

Requires user role: ADMIN

Default value: On

Value space: Off/On

Off: The far end is not allowed to select your video sources or to control your local camera (pan, tilt, zoom).

On: Allows the far end to be able to select your video sources and control your local camera (pan, tilt, zoom). You will still be able to control your camera and select your video sources as normal.

## Conference FarEndControl SignalCapability

Define the far end control (H.224) signal capability mode.

Requires user role: ADMIN

Default value: On

Value space: Off/On

Off: Disable the far end control signal capability.

On: Enable the far end control signal capability.

## Conference FarEndMessage Mode

Toggle whether it is allowed to send data between two codecs in a point-to-point call, for use with control systems or macros. Works with SIP calls only. This setting will enable/disable the use of the xCommand Call FarEndMessage Send command.

Requires user role: ADMIN

Default value: Off

Value space: Off/On

Off: It is not possible to send messages between two codecs.

On: It is possible to send messages between two codecs in a point-to-point call.

## Conference MaxReceiveCallRate

Define the maximum receive bit rate to be used when placing or receiving calls. Note that this is the maximum bit rate for each individual call; use the Conference MaxTotalReceiveCallRate setting to set the aggregated maximum for all simultaneous active calls.

Requires user role: ADMIN

Default value: 6000

Value space: Integer (64..6000)

The maximum receive call rate (kbps).

## Conference MaxTransmitCallRate

Define the maximum transmit bit rate to be used when placing or receiving calls. Note that this is the maximum bit rate for each individual call; use the Conference MaxTotalTransmitCallRate setting to set the aggregated maximum for all simultaneous active calls.

Requires user role: ADMIN

Default value: 6000

Value space: Integer (64..6000)

The maximum transmitt call rate (kbps).

## Conference MaxTotalReceiveCallRate

This configuration applies when using a video system's built-in MultiSite feature (optional) to host a multipoint video conference.

Define the maximum overall receive bit rate allowed. The bit rate will be divided fairly among all active calls at any time. This means that the individual calls will be up-speeded or down-speeded as appropriate when someone leaves or enters a multipoint conference, or when a call is put on hold (suspended) or resumed.

The maximum receive bit rate for each individual call is defined in the Conference MaxReceiveCallRate setting.

Requires user role: ADMIN

Default value: 15000

Value space: Integer (64..15000)

The maximum receive call rate (kbps).

## Conference MaxTotalTransmitCallRate

This configuration applies when using a video system's built-in MultiSite feature (optional) to host a multipoint video conference.

Define the maximum overall transmit bit rate allowed. The bit rate will be divided fairly among all active calls at any time. This means that the individual calls will be up-speeded or down-speeded as appropriate when someone leaves or enters a multipoint conference, or when a call is put on hold (suspended) or resumed.

The maximum transmit bit rate for each individual call is defined in the Conference MaxTransmitCallRate setting.

Requires user role: ADMIN

Default value: 15000

Value space: Integer (64..15000)

The maximum transmit call rate (kbps).

## Conference MicUnmuteOnDisconnect Mode

Define if the microphones shall be unmuted automatically when all calls are disconnected. In a meeting room or other shared resources this may be done to prepare the system for the next user.

Requires user role: ADMIN

Default value: On

Value space: Off/On

Off: If muted during a call, let the microphones remain muted after the call is disconnected.

On: Unmute the microphones after the call is disconnected.

## Conference Multipoint Mode

Define how the video system handles multiparty video conferences (ad hoc conferences).

If registered to a Cisco TelePresence Video Communication Server (VCS), the video system can use its own built-in MultiSite feature. If registered to a Cisco Unified Communications Manager (CUCM) version 8.6.2 or newer, the video system can use either the CUCM conference bridge, or the video system's own built-in MultiSite feature. Which option to use, is set-up by CUCM.

The CUCM conference bridge allows you to set up conferences with many participants. The built-in MultiSite allows up to four participants (yourself included).

The built-in MultiSite is optional and may not be available on all video systems.

Requires user role: ADMIN

Default value: Auto

Value space: Auto/CUCMMediaResourceGroupList/MultiSite/Off

Auto: The multipoint method is selected automatically; if no multipoint method is available, the Multipoint Mode will be set to Off.

CUCMMediaResourceGroupList: Multiparty conferences are hosted by the CUCM configured conference bridge. This setting is provisioned by CUCM in a CUCM environment, and should never be set manually by the user.

MultiSite: Multiparty conferences are set up using the built-in MultiSite feature. If MultiSite is selected when the MultiSite feature is not available, the Multipoint Mode will automatically be set to Off.

Off: Multiparty conferences are not allowed.

## Conference MultiStream Mode

The video system supports multistream video for conferences.

Requires user role: ADMIN

Default value: Auto

Value space: Auto/Off

Auto: Multistream will be used when the conference infrastructure supports the feature. Minimum versions required: CMS 2.2, CUCM 11.5, VCS X8.7.

Off: Multistream is disabled.

## Conference IncomingMultisiteCall Mode

Select whether or not to allow incoming calls when already in a call/conference.

Requires user role: ADMIN

Default value: Allow

Value space: Allow/Deny

**Allow:** You will be notified when someone calls you while you are already in a call. You can accept the incoming call or not. The ongoing call may be put on hold while answering the incoming call; or you may merge the calls (requires support for multiparty video conferences).

**Deny:** An incoming call will be rejected if you are already in a call. You will not be notified about the incoming call. However, the call will appear as a missed call in the call history list.

## Conference Presentation OnPlacedOnHold

Define whether or not to continue sharing a presentation after the remote site has put you on hold.

Requires user role: ADMIN

Default value: NoAction

Value space: NoAction/Stop

**NoAction:** The video system will not stop the presentation sharing when put on hold. The presentation will not be shared while you are on hold, but it will continue automatically when the call is resumed.

**Stop:** The video system stops the presentation sharing when the remote site puts you on hold. The presentation will not continue when the call is resumed.

## Conference Presentation RelayQuality

This configuration applies to video systems that are using the built-in MultiSite feature (optional) to host a multipoint video conference. When a remote user shares a presentation, the video system will transcode the presentation and send it to the other participants in the multipoint conference. The RelayQuality setting specifies whether to give priority to high frame rate or to high resolution for the presentation source.

Requires user role: ADMIN

Default value: Sharpness

Value space: Motion/Sharpness

**Motion:** Gives the highest possible frame rate. Used when there is a need for higher frame rates, typically when there is a lot of motion in the picture.

**Sharpness:** Gives the highest possible resolution. Used when you want the highest quality of detailed images and graphics.

## Conference VideoBandwidth Mode

Define the conference video bandwidth mode.

Requires user role: ADMIN

Default value: Dynamic

Value space: Dynamic/Static

**Dynamic:** The available transmit bandwidth for the video channels are distributed among the currently active channels. If there is no presentation, the main video channels will use the bandwidth of the presentation channel.

**Static:** The available transmit bandwidth is assigned to each video channel, even if it is not active.

## FacilityService settings

### FacilityService Service [1..5] Type

Up to five different facility services can be supported simultaneously. With this setting you can select what kind of services they are. A facility service is not available unless both the FacilityService Service [n] Name and the FacilityService Service [n] Number settings are properly set. Facility services are available from the user interface.

Requires user role: ADMIN, INTEGRATOR

Default value: Helpdesk

Value space: Catering/Concierge/Emergency/Helpdesk/Security/Transportation/Other

Catering: Select this option for catering services.

Concierge: Select this option for concierge services.

Emergency: Select this option for emergency services.

Helpdesk: Select this option for helpdesk services.

Security: Select this option for security services.

Transportation: Select this option for transportation services.

Other: Select this option for services not covered by the other options.

### FacilityService Service [1..5] Name

Define the name of the facility service. Up to five different facility services are supported. A facility service is not available unless both the FacilityService Service [n] Name and the FacilityService Service [n] Number settings are properly set. The name will show on the facility service call button, which appears when you tap the question mark icon in the top bar. Facility services are available from the user interface.

Requires user role: ADMIN, INTEGRATOR

Default value: Service 1: "Live Support" Other services: ""

Value space: String (0, 1024)

The name of the facility service.

### FacilityService Service [1..5] Number

Define the number (URI or phone number) of the facility service. Up to five different facility services are supported. A facility service is not available unless both the FacilityService Service [n] Name and the FacilityService Service [n] Number settings are properly set. Facility services are available from the user interface.

Requires user role: ADMIN, INTEGRATOR

Default value: ""

Value space: String (0, 1024)

The number (URI or phone number) of the facility service.

### FacilityService Service [1..5] CallType

Define the call type for each facility service. Up to five different facility services are supported. A facility service is not available unless both the FacilityService Service [n] Name and the FacilityService Service [n] Number settings are properly set. Facility services are available from the user interface.

Requires user role: ADMIN, INTEGRATOR

Default value: Video

Value space: Audio/Video

Audio: Select this option for audio calls.

Video: Select this option for video calls.

## GPIO settings

### GPIO Pin [1..4] Mode

The four GPIO pins are configured individually. The state can be retrieved by `xStatus GPIO Pin [1..4] State`. The default pin state is High (+12 V). When activated as an output, a pin is set to 0 V (Low); when deactivated, it is set to +12 V (High). To activate a pin as an input, the voltage on the pin must be pulled down to 0 V; to deactivate it, raise the voltage to +12 V.

Requires user role: ADMIN, INTEGRATOR

Default value: InputNoAction

Value space: InputAcceptAllCalls/InputDisconnectAllCalls/InputMuteMicrophones/  
InputNoAction/OutputAllCallsEncrypted/OutputInCall/OutputManualState/  
OutputMicrophonesMuted/OutputPresentationOn/OutputStandbyActive

`InputAcceptAllCalls`: When the pin is activated, the `xCommand Call Accept` command, which accepts all incoming calls, will be issued.

`InputDisconnectAllCalls`: When the pin is activated, the `xCommand Call Disconnect` command, which disconnects all calls, will be issued.

`InputMuteMicrophones`: When the pin is activated, the microphones will be muted. When deactivated, the microphones will be unmuted.

`InputNoAction`: The pin state can be set, but no operation is performed.

`OutputAllCallsEncrypted`: The pin is activated when all calls are encrypted, and deactivated when one or more calls are not encrypted.

`OutputInCall`: The pin is activated when in call, and deactivated when not in call.

`OutputManualState`: The pin state can be set by `xCommand GPIO ManualState Set PinX`: High/Low. It is set to +12 V or 0 V, respectively.

`OutputMicrophonesMuted`: The pin is activated when microphones are muted, and deactivated when not muted.

`OutputPresentationOn`: The pin is activated when presentation is active, and deactivated when presentation is not active.

`OutputStandbyActive`: The pin is activated when the system is in standby mode, and deactivated when no longer in standby.



## H323 settings

### H323 Authentication Mode

Define the authenticatin mode for the H.323 profile.

Requires user role: ADMIN

Default value: Off

Value space: Off/On

Off: The system will not try to authenticate itself to a H.323 Gatekeeper, but will still try a normal registration.

On: If an H.323 Gatekeeper indicates that it requires authentication, the system will try to authenticate itself to the gatekeeper. Requires the H323 Authentication LoginName and H323 Authentication Password settings to be defined on both the codec and the Gatekeeper.

### H323 Authentication LoginName

The system sends the H323 Authentication Login Name and the H323 Authentication Password to an H.323 Gatekeeper for authentication. The authentication is a one way authentication from the codec to the H.323 Gatekeeper, i.e. the system is authenticated to the gatekeeper. If the H.323 Gatekeeper indicates that no authentication is required, the system will still try to register. Requires the H.323 Authentication Mode to be enabled.

Requires user role: ADMIN

Default value: ""

Value space: String (0, 50)

The authentication login name.

### H323 Authentication Password

The system sends the H323 Authentication Login Name and the H323 Authentication Password to an H.323 Gatekeeper for authentication. The authentication is a one way authentication from the codec to the H.323 Gatekeeper, i.e. the system is authenticated to the gatekeeper. If the H.323 Gatekeeper indicates that no authentication is required, the system will still try to register. Requires the H.323 Authentication Mode to be enabled.

Requires user role: ADMIN

Default value: ""

Value space: String (0, 50)

The authentication password.

### H323 CallSetup Mode

Defines whether to use a Gatekeeper or Direct calling when establishing H.323 calls. Direct H.323 calls can be made also when H323 CallSetup Mode is set to Gatekeeper.

Requires user role: ADMIN

Default value: Gatekeeper

Value space: Direct/Gatekeeper

Direct: You can only make an H.323 call by dialing an IP address directly.

Gatekeeper: The system uses a Gatekeeper to make an H.323 call. When choosing this option, the H323 Gatekeeper Address must also be configured.

## H323 Encryption KeySize

Define the minimum or maximum key size for the Diffie-Hellman key exchange method, which is used when establishing the Advanced Encryption Standard (AES) encryption key.

Requires user role: ADMIN

Default value: Min1024bit

Value space: Max1024bit/Min1024bit/Min2048bit

Max1024bit: The maximum size is 1024 bit.

Min1024bit: The minimum size is 1024 bit.

Min2048bit: The minimum size is 2048 bit.

## H323 Gatekeeper Address

Define the IP address of the Gatekeeper. Requires H323 CallSetup Mode to be set to Gatekeeper.

Requires user role: ADMIN

Default value: ""

Value space: String (0, 255)

A valid IPv4 address, IPv6 address or DNS name.

## H323 H323Alias E164

The H.323 Alias E.164 defines the address of the system, according to the numbering plan implemented in the H.323 Gatekeeper. The E.164 alias is equivalent to a telephone number, sometimes combined with access codes.

Requires user role: ADMIN

Default value: ""

Value space: String (0, 30)

The H.323 Alias E.164 address. Valid characters are 0-9, \* and #.

## H323 H323Alias ID

Define the H.323 Alias ID, which is used to address the system on a H.323 Gatekeeper and will be displayed in the call lists.

Requires user role: ADMIN

Default value: ""

Value space: String (0, 49)

The H.323 Alias ID. Example: "firstname.lastname@company.com", "My H.323 Alias ID"

## H323 NAT Mode

The firewall traversal technology creates a secure path through the firewall barrier, and enables proper exchange of audio/video data when connected to an external video conferencing system (when the IP traffic goes through a NAT router). NOTE: NAT does not work in conjunction with gatekeepers.

Requires user role: ADMIN

Default value: Off

Value space: Auto/Off/On

Auto: The system will determine if the H323 NAT Address or the real IP address should be used in signaling. This makes it possible to place calls to endpoints on the LAN as well as endpoints on the WAN. If the H323 NAT Address is wrong or not set, the real IP address will be used.

Off: The system will signal the real IP address.

On: The system will signal the configured H323 NAT Address instead of its real IP address in Q.931 and H.245. The NAT server address will be shown in the startup-menu as: "My IP Address: 10.0.2.1". If the H323 NAT Address is wrong or not set, H.323 calls cannot be set up.

## H323 NAT Address

Define the external/global IP address to the router with NAT support. Packets sent to the router will then be routed to the system. Note that NAT cannot be used when registered to a gatekeeper.

In the router, the following ports must be routed to the system's IP address:

- \* Port 1720
- \* Port 5555-6555
- \* Port 2326-2487

Requires user role: ADMIN

Default value: ""

Value space: String (0, 64)

A valid IPv4 address or IPv6 address.

## H323 PortAllocation

This setting affects the H.245 port numbers used for H.323 call signaling.

Requires user role: ADMIN

Default value: Dynamic

Value space: Dynamic/Static

**Dynamic:** The system will allocate which ports to use when opening a TCP connection. The reason for doing this is to avoid using the same ports for subsequent calls, as some firewalls consider this as a sign of attack. When Dynamic is selected, the H.323 ports used are from 11000 to 20999. Once 20999 is reached they restart again at 11000. The ports are automatically selected by the system within the given range. Firewall administrators should not try to deduce which ports are used when, as the allocation schema within the mentioned range may change without any further notice.

**Static:** When set to Static the ports are given within a static predefined range [5555-6555].

## Logging settings

### Logging External Mode

Determine whether or not to use a remote syslog server for logging.

Requires user role: ADMIN

Default value: Off

Value space: Off/On

Off: Disable logging to a remote syslog server.

On: Enable logging to a remote syslog server.

### Logging External Protocol

Determine which protocol to use toward the remote logging server. You can use either the syslog protocol over TLS (Transport Layer Security), or the syslog protocol in plaintext. For details about the syslog protocol, see RFC 5424.

Requires user role: ADMIN

Default value: SyslogTLS

Value space: Syslog/SyslogTLS

Syslog: Syslog protocol in plain text.

SyslogTLS: Syslog protocol over TLS.

### Logging External Server Address

The address of the remote syslog server.

Requires user role: ADMIN

Default value: ""

Value space: String (0, 255)

A valid IPv4 address, IPv6 address or DNS name.

### Logging External Server Port

The port that the remote syslog server listens for messages on. If set to 0, the video system will use the standard syslog port. The standard syslog port is 514 for syslog, and 6514 for syslog over TLS.

Requires user role: ADMIN

Default value: 514

Value space: Integer (0..65535)

The number of the port that the remote syslog server is using. 0 means that the video system uses the standard syslog port.

### Logging Mode

Define the logging mode for the video system (syslog service). When disabled, the syslog service does not start, and most of the event logs are not generated. The Historical Logs and Call Logs are not affected.

Requires user role: ADMIN

Default value: On

Value space: Off/On

Off: Disable the system logging service.

On: Enable the system logging service.

## Macros settings

### Macros Mode

Macros allow you to write snippets of JavaScript code that can automate parts of your video endpoint, thus creating custom behavior. Use of macros is disabled by default, but the first time you open the Macro Editor you will be asked whether to enable use of macros on the codec. Use this setting when you want to manually enable, or to permanently disable the use of macros on the codec. You can disable the use of macros within the Macro Editor. But this will not permanently disable macros from running, because every time the codec is reset the macros will be re-enabled automatically.

Requires user role: ADMIN

Default value: Off

Value space: Off/On

Off: Permanently disable the use of macros on this video system.

On: Enable the use of macros on this video system.

### Macros AutoStart

All the macros run in a single process on the video endpoint, called the macro runtime. It should be running by default, but you can choose to stop and start it manually. If you restart the video system, the runtime will automatically start again if auto start is enabled.

Requires user role: ADMIN

Default value: On

Value space: Off/On

Off: The macro runtime will not start automatically after a restart of the video system.

On: The macro runtime will start automatically after a restart of the video system.

## Network settings

### Network [1..1] DNS DNSSEC Mode

Domain Name System Security extensions (DNSSEC) is a set of extensions to DNS. It is used to authenticate DNS replies for zones that are signed. It will still allow unsigned zones.

Requires user role: ADMIN

Default value: Off

Value space: Off/On

Off: Disable Domain Name System Security Extensions.

On: Enable Domain Name System Security Extensions.

### Network [1..1] DNS Domain Name

The DNS Domain Name is the default domain name suffix which is added to unqualified names.

Example: If the DNS Domain Name is "company.com" and the name to lookup is "MyVideoSystem", this will result in the DNS lookup "MyVideoSystem.company.com".

Requires user role: ADMIN, USER

Default value: ""

Value space: String (0, 64)

The DNS domain name.

### Network [1..1] DNS Server [1..3] Address

Define the network addresses for DNS servers. Up to three addresses may be specified. If the network addresses are unknown, contact your administrator or Internet Service Provider.

Requires user role: ADMIN, USER

Default value: ""

Value space: String (0, 64)

A valid IPv4 address or IPv6 address.

### Network [1..1] IEEE8021X Mode

The system can be connected to an IEEE 802.1X LAN network, with a port-based network access control that is used to provide authenticated network access for Ethernet networks.

Requires user role: ADMIN, USER

Default value: Off

Value space: Off/On

Off: The 802.1X authentication is disabled.

On: The 802.1X authentication is enabled.

### Network [1..1] IEEE8021X TlsVerify

Verification of the server-side certificate of an IEEE802.1x connection against the certificates in the local CA-list when TLS is used. The CA-list must be uploaded to the video system. This can be done from the web interface.

This setting takes effect only when Network [1] IEEE8021X Eap Tls is enabled (On).

Requires user role: ADMIN, USER

Default value: Off

Value space: Off/On

Off: When set to Off, TLS connections are allowed without verifying the server-side X.509 certificate against the local CA-list. This should typically be selected if no CA-list has been uploaded to the codec.

On: When set to On, the server-side X.509 certificate will be validated against the local CA-list for all TLS connections. Only servers with a valid certificate will be allowed.

## Network [1..1] IEEE8021X UseClientCertificate

Authentication using a private key/certificate pair during an IEEE802.1x connection. The authentication X.509 certificate must be uploaded to the video system. This can be done from the web interface.

Requires user role: ADMIN, USER

Default value: Off

Value space: Off/On

Off: When set to Off client-side authentication is not used (only server-side).

On: When set to On the client (video system) will perform a mutual authentication TLS handshake with the server.

## Network [1..1] IEEE8021X Identity

Define the user name for 802.1X authentication.

Requires user role: ADMIN, USER

Default value: ""

Value space: String (0, 64)

The user name for 802.1X authentication.

## Network [1..1] IEEE8021X Password

Define the password for 802.1X authentication.

Requires user role: ADMIN, USER

Default value: ""

Value space: String (0, 50)

The password for 802.1X authentication.

## Network [1..1] IEEE8021X AnonymousIdentity

The 802.1X Anonymous ID string is to be used as unencrypted identity with EAP (Extensible Authentication Protocol) types that support different tunneled identity, like EAP-PEAP and EAP-TTLS. If set, the anonymous ID will be used for the initial (unencrypted) EAP Identity Request.

Requires user role: ADMIN, USER

Default value: ""

Value space: String (0, 64)

The 802.1X Anonymous ID string.

## Network [1..1] IEEE8021X Eap Md5

Define the Md5 (Message-Digest Algorithm 5) mode. This is a Challenge Handshake Authentication Protocol that relies on a shared secret. Md5 is a Weak security.

Requires user role: ADMIN, USER

Default value: On

Value space: Off/On

Off: The EAP-MD5 protocol is disabled.

On: The EAP-MD5 protocol is enabled.

## Network [1..1] IEEE8021X Eap Ttls

Define the TTLS (Tunneled Transport Layer Security) mode. Authenticates LAN clients without the need for client certificates. Developed by Funk Software and Certicom. Usually supported by Agere Systems, Proxim and Avaya.

Requires user role: ADMIN, USER

Default value: On

Value space: Off/On

Off: The EAP-TTLS protocol is disabled.

On: The EAP-TTLS protocol is enabled.

## Network [1..1] IEEE8021X Eap Tls

Enable or disable the use of EAP-TLS (Transport Layer Security) for IEEE802.1x connections. The EAP-TLS protocol, defined in RFC 5216, is considered one of the most secure EAP standards. LAN clients are authenticated using client certificates.

Requires user role: ADMIN, USER

Default value: On

Value space: Off/On

Off: The EAP-TLS protocol is disabled.

On: The EAP-TLS protocol is enabled.

## Network [1..1] IEEE8021X Eap Peap

Define the Peap (Protected Extensible Authentication Protocol) mode. Authenticates LAN clients without the need for client certificates. Developed by Microsoft, Cisco and RSA Security.

Requires user role: ADMIN, USER

Default value: On

Value space: Off/On

Off: The EAP-PEAP protocol is disabled.

On: The EAP-PEAP protocol is enabled.

## Network [1..1] IPStack

Select if the system should use IPv4, IPv6, or dual IP stack, on the network interface. NOTE: After changing this setting you may have to wait up to 30 seconds before it takes effect.

Requires user role: ADMIN, USER

Default value: Dual

Value space: Dual/IPv4/IPv6

Dual: When set to Dual, the network interface can operate on both IP versions at the same time, and can have both an IPv4 and an IPv6 address at the same time.

IPv4: When set to IPv4, the system will use IPv4 on the network interface.

IPv6: When set to IPv6, the system will use IPv6 on the network interface.

## Network [1..1] IPv4 Assignment

Define how the system will obtain its IPv4 address, subnet mask and gateway address.

When using DHCP for address assignment, "01" appended by the MAC address is used as client identifier in DHCP requests.

Requires user role: ADMIN, USER

Default value: DHCP

Value space: Static/DHCP

Static: The addresses must be configured manually using the Network IPv4 Address, Network IPv4 Gateway and Network IPv4 SubnetMask settings (static addresses).

DHCP: The system addresses are automatically assigned by the DHCP server.

## Network [1..1] IPv4 Address

Define the static IPv4 network address for the system. Applicable only when Network IPv4 Assignment is set to Static.

Requires user role: ADMIN, USER

Default value: ""

Value space: String (0, 64)

A valid IPv4 address.

## Network [1..1] IPv4 Gateway

Define the IPv4 network gateway address. Applicable only when the Network IPv4 Assignment is set to Static.

Requires user role: ADMIN, USER

Default value: ""

Value space: String (0, 64)

A valid IPv4 address.



## Network [1..1] IPv4 SubnetMask

Define the IPv4 network subnet mask. Applicable only when the Network IPv4 Assignment is set to Static.

Requires user role: ADMIN, USER

Default value: ""

Value space: String (0, 64)

A valid IPv4 address.

## Network [1..1] IPv6 Assignment

Define how the system will obtain its IPv6 address and the default gateway address.

When using DHCPv6 for address assignment, "01" appended by the MAC address is used as client identifier in DHCP requests.

Requires user role: ADMIN, USER

Default value: Autoconf

Value space: Static/DHCPv6/Autoconf

**Static:** The codec and gateway IP addresses must be configured manually using the Network IPv6 Address and Network IPv6 Gateway settings. The options, for example NTP and DNS server addresses, must either be set manually or obtained from a DHCPv6 server. The Network IPv6 DHCPOptions setting determines which method to use.

**DHCPv6:** All IPv6 addresses, including options, will be obtained from a DHCPv6 server. See RFC 3315 for a detailed description. The Network IPv6 DHCPOptions setting will be ignored.

**Autoconf:** Enable IPv6 stateless autoconfiguration of the IPv6 network interface. See RFC 4862 for a detailed description. The options, for example NTP and DNS server addresses, must either be set manually or obtained from a DHCPv6 server. The Network IPv6 DHCPOptions setting determines which method to use.

## Network [1..1] IPv6 Address

Define the static IPv6 network address for the system. Applicable only when the Network IPv6 Assignment is set to Static.

Requires user role: ADMIN, USER

Default value: ""

Value space: String (0, 64)

A valid IPv6 address including a network mask. Example: 2001:DB8::/48

## Network [1..1] IPv6 Gateway

Define the IPv6 network gateway address. This setting is only applicable when the Network IPv6 Assignment is set to Static.

Requires user role: ADMIN, USER

Default value: ""

Value space: String (0, 64)

A valid IPv6 address.

## Network [1..1] IPv6 DHCPOptions

Retrieve a set of DHCP options, for example NTP and DNS server addresses, from a DHCPv6 server.

Requires user role: ADMIN, USER

Default value: On

Value space: Off/On

**Off:** Disable the retrieval of DHCP options from a DHCPv6 server.

**On:** Enable the retrieval of a selected set of DHCP options from a DHCPv6 server.

## Network [1..1] MTU

Define the Ethernet MTU (Maximum Transmission Unit) size. The MTU size must be supported by your network infrastructure. The minimum size is 576 for IPv4 and 1280 for IPv6.

Requires user role: ADMIN, USER

Default value: 1500

Value space: Integer (576..1500)

Set a value for the MTU (bytes).

## Network [1..1] QoS Mode

The QoS (Quality of Service) is a method which handles the priority of audio, video and data in the network. The QoS settings must be supported by the infrastructure. Diffserv (Differentiated Services) is a computer networking architecture that specifies a simple, scalable and coarse-grained mechanism for classifying, managing network traffic and providing QoS priorities on modern IP networks.

Requires user role: ADMIN, USER

Default value: Diffserv

Value space: Off/Diffserv

Off: No QoS method is used.

Diffserv: When you set the QoS Mode to DiffServ, the Network QoS DiffServ Audio, Network QoS DiffServ Video, Network QoS DiffServ Data, Network QoS DiffServ Signalling, Network QoS DiffServ ICMPv6 and Network QoS DiffServ NTP settings are used to prioritize packets.

## Network [1..1] QoS DiffServ Audio

This setting will only take effect if Network QoS Mode is set to DiffServ.

Define which priority Audio packets should have in the IP network.

The priority for the packets ranges from 0 to 63 - the higher the number, the higher the priority. The recommended class for Audio is CS4, which equals the decimal value 32. If in doubt, contact your network administrator.

The priority set here might be overridden when packets are leaving the network controlled by the local network administrator.

Requires user role: ADMIN, USER

Default value: 0

Value space: Integer (0..63)

Set the priority of the audio packets in the IP network - the higher the number, the higher the priority. 0 means "best effort".

## Network [1..1] QoS DiffServ Video

This setting will only take effect if Network QoS Mode is set to DiffServ.

Define which priority Video packets should have in the IP network. The packets on the presentation channel (shared content) are also in the Video packet category. The priority for the packets ranges from 0 to 63 - the higher the number, the higher the priority. The recommended class for Video is CS4, which equals the decimal value 32. If in doubt, contact your network administrator.

The priority set here might be overridden when packets are leaving the network controlled by the local network administrator.

Requires user role: ADMIN, USER

Default value: 0

Value space: Integer (0..63)

Set the priority of the video packets in the IP network - the higher the number, the higher the priority. 0 means "best effort".

## Network [1..1] QoS Diffserv Data

This setting will only take effect if Network QoS Mode is set to Diffserv.

Define which priority Data packets should have in the IP network.

The priority for the packets ranges from 0 to 63 - the higher the number, the higher the priority. The recommended value for Data is 0, which means best effort. If in doubt, contact your network administrator.

The priority set here might be overridden when packets are leaving the network controlled by the local network administrator.

Requires user role: ADMIN, USER

Default value: 0

Value space: Integer (0..63)

Set the priority of the data packets in the IP network - the higher the number, the higher the priority. 0 means "best effort".

## Network [1..1] QoS Diffserv Signalling

This setting will only take effect if Network QoS Mode is set to Diffserv.

Define which priority Signalling packets that are deemed critical (time-sensitive) for the real-time operation should have in the IP network.

The priority for the packets ranges from 0 to 63 - the higher the number, the higher the priority. The recommended class for Signalling is CS3, which equals the decimal value 24. If in doubt, contact your network administrator.

The priority set here might be overridden when packets are leaving the network controlled by the local network administrator.

Requires user role: ADMIN, USER

Default value: 0

Value space: Integer (0..63)

Set the priority of the signalling packets in the IP network - the higher the number, the higher the priority. 0 means "best effort".

## Network [1..1] QoS Diffserv ICMPv6

This setting will only take effect if Network QoS Mode is set to Diffserv.

Define which priority ICMPv6 packets should have in the IP network.

The priority for the packets ranges from 0 to 63 - the higher the number, the higher the priority. The recommended value for ICMPv6 is 0, which means best effort. If in doubt, contact your network administrator.

The priority set here might be overridden when packets are leaving the network controlled by the local network administrator.

Requires user role: ADMIN, USER

Default value: 0

Value space: Integer (0..63)

Set the priority of the ICMPv6 packets in the IP network - the higher the number, the higher the priority. 0 means "best effort".

## Network [1..1] QoS Diffserv NTP

This setting will only take effect if Network QoS Mode is set to Diffserv.

Define which priority NTP packets should have in the IP network.

The priority for the packets ranges from 0 to 63 - the higher the number, the higher the priority. The recommended value for NTP is 0, which means "best effort". If in doubt, contact your network administrator.

The priority set here might be overridden when packets are leaving the network controlled by the local network administrator.

Requires user role: ADMIN, USER

Default value: 0

Value space: Integer (0..63)

Set the priority of the NTP packets in the IP network - the higher the number, the higher the priority. 0 means "best effort".

## Network [1..1] RemoteAccess Allow

Define which IP addresses (IPv4/IPv6) are allowed for remote access to the codec from SSH/HTTP/HTTPS. Multiple IP addresses are separated by a white space.

A network mask (IP range) is specified by <ip address>/N, where N is 1-32 for IPv4, and N is 1-128 for IPv6. The /N is a common indication of a network mask where the first N bits are set. Thus 192.168.0.0/24 would match any address starting with 192.168.0, since these are the first 24 bits in the address.

Requires user role: ADMIN, USER

Default value: ""

Value space: String (0..255)

A valid IPv4 address or IPv6 address.

## Network [1..1] Speed

Define the Ethernet link speed. We recommend not to change from the default value, which negotiates with the network to set the speed automatically. If you do not use auto-negotiation, make sure that the speed you choose is supported by the closest switch in your network infrastructure.

Requires user role: ADMIN, INTEGRATOR

Default value: Auto

Value space: Auto/10half/10full/100half/100full/1000full

Auto: Auto-negotiate link speed.

10half: Force link to 10 Mbps half-duplex.

10full: Force link to 10 Mbps full-duplex.

100half: Force link to 100 Mbps half-duplex.

100full: Force link to 100 Mbps full-duplex.

1000full: Force link to 1 Gbps full-duplex.

## Network [1..1] TrafficControl Mode

Define the network traffic control mode to decide how to control the video packets transmission speed.

Requires user role: ADMIN, USER

Default value: On

Value space: Off/On

Off: Transmit video packets at link speed.

On: Transmit video packets at maximum 20 Mbps. Can be used to smooth out bursts in the outgoing network traffic.

## Network [1..1] VLAN Voice Mode

Define the VLAN voice mode. The VLAN Voice Mode will be set to Auto automatically if you have Cisco UCM (Cisco Unified Communications Manager) as provisioning infrastructure. Note that Auto mode will NOT work if the NetworkServices CDP Mode setting is Off.

Requires user role: ADMIN, USER

Default value: Auto

Value space: Auto/Manual/Off

Auto: The Cisco Discovery Protocol (CDP), if available, assigns an id to the voice VLAN. If CDP is not available, VLAN is not enabled.

Manual: The VLAN ID is set manually using the Network VLAN Voice VlanId setting. If CDP is available, the manually set value will be overruled by the value assigned by CDP.

Off: VLAN is not enabled.

## Network [1..1] VLAN Voice VlanId

Define the VLAN voice ID. This setting will only take effect if Network VLAN Voice Mode is set to Manual.

Requires user role: ADMIN, USER

Default value: 1

Value space: Integer (1..4094)

Set the VLAN voice ID.

## NetworkServices settings

### NetworkServices CDP Mode

Enable or disable the CDP (Cisco Discovery Protocol) daemon. Enabling CDP will make the endpoint report certain statistics and device identifiers to a CDP-enabled switch. If CDP is disabled, the Network VLAN Voice Mode: Auto setting will not work.

Requires user role: ADMIN

Default value: On

Value space: Off/On

Off: The CDP daemon is disabled.

On: The CDP daemon is enabled.

### NetworkServices H323 Mode

Define whether the system should be able to place and receive H.323 calls or not.

Requires user role: ADMIN

Default value: Off

Value space: Off/On

Off: Disable the possibility to place and receive H.323 calls.

On: Enable the possibility to place and receive H.323 calls.

### NetworkServices HTTP Mode

Define whether or not to allow access to the video system using the HTTP or HTTPS (HTTP Secure) protocols. Note that the video system's web interface use HTTP or HTTPS. If this setting is switched Off, you cannot use the web interface.

For additional security (encryption and decryption of requests and pages that are returned by the web server), allow only HTTPS.

Note: The default value is HTTP+HTTPS for video systems that have been upgraded to CE9.4 (or later) from an earlier software version, provided that the video system has not been factory reset after the upgrade.

Requires user role: ADMIN

Default value: HTTPS (changed from HTTP+HTTPS to HTTPS in CE9.4)

Value space: Off/HTTP+HTTPS/HTTPS

Off: Access to the video system not allowed via HTTP or HTTPS.

HTTP+HTTPS: Access to the video system allowed via both HTTP and HTTPS.

HTTPS: Access to the video system allowed via HTTPS, but not via HTTP.

### NetworkServices HTTP Proxy LoginName

This is the user name part of the credentials for authentication towards the HTTP proxy. Requires that the NetworkServices HTTP Proxy Mode is set to Manual.

Requires user role: ADMIN, USER

Default value: ""

Value space: String (0, 80)

The authentication login name.

## NetworkServices HTTP Proxy Password

This is the password part of the credentials for authentication towards the HTTP proxy. Requires that the NetworkServices HTTP Proxy Mode is set to Manual.

Requires user role: ADMIN, USER

Default value: ""

Value space: String (0, 64)

The authentication password.

## NetworkServices HTTP Proxy Mode

The HTTP proxy for Cisco Webex can be set up manually, it can be auto-configured (PACUrl), fully automated (WPAD), or it can be turned off.

Requires user role: ADMIN, USER

Default value: Off

Value space: Manual/Off/PACUrl/WPAD

Manual: Enter the address of the proxy server in the NetworkServices HTTP Proxy URL setting. Optionally, also add the HTTP proxy login name and password in the NetworkServices HTTP Proxy LoginName/Password settings.

Off: The HTTP proxy mode is turned off.

PACUrl: The HTTP proxy is auto-configured. You must enter the URL for the PAC (Proxy Auto Configuration) script in the NetworkServices HTTP Proxy PACUrl setting.

WPAD: With WPAD (Web Proxy Auto Discovery) the HTTP proxy is fully automated and auto-configured.

## NetworkServices HTTP Proxy Url

Set the URL of the HTTP proxy server. Requires that the NetworkServices HTTP Proxy Mode is set to Manual.

Requires user role: ADMIN, USER

Default value: ""

Value space: String (0..255)

The URL of the HTTP proxy server.

## NetworkServices HTTP Proxy PACUrl

Set the URL of the PAC (Proxy Auto Configuration) script. Requires that the NetworkServices HTTP Proxy Mode is set to PACUrl.

Requires user role: ADMIN, USER

Default value: ""

Value space: String (0..255)

The URL of the PAC (Proxy Auto Configuration) script.

## NetworkServices HTTPS OCSP Mode

Define the support for OCSP (Online Certificate Status Protocol) responder services. The OCSP feature allows users to enable OCSP instead of certificate revocation lists (CRLs) to check the certificate status.

For any outgoing HTTPS connection, the OCSP responder is queried of the status. If the corresponding certificate has been revoked, then the HTTPS connection will not be used.

Requires user role: ADMIN

Default value: Off

Value space: Off/On

Off: Disable OCSP support.

On: Enable OCSP support.

## NetworkServices HTTPS OCSP URL

Define the URL of the OCSP responder (server) that will be used to check the certificate status.

Requires user role: ADMIN

Default value: ""

Value space: String (0..255)

A valid URL.

## NetworkServices HTTPS Server MinimumTLSVersion

Set the lowest version of the TLS (Transport Layer Security) protocol that is allowed.

Requires user role: ADMIN

Default value: TLSv1.1

Value space: TLSv1.1/TLSv1.2

TLSv1.1: Support of TLS version 1.1 or higher.

TLSv1.2: Support of TLS version 1.2 or higher.

## NetworkServices HTTPS StrictTransportSecurity

The HTTP Strict Transport Security header lets a web site inform the browser that it should never load the site using HTTP and should automatically convert all attempts to access the site using HTTP to HTTPS requests instead.

Requires user role: ADMIN

Default value: Off

Value space: Off/On

Off: The HTTP strict transport security feature is disabled.

On: The HTTP strict transport security feature is enabled.

## NetworkServices HTTPS VerifyServerCertificate

When the video system connects to an external HTTPS server (like a phone book server or an external manager), this server will present a certificate to the video system to identify itself.

Requires user role: ADMIN

Default value: Off

Value space: Off/On

Off: Do not verify server certificates.

On: Requires the system to verify that the server certificate is signed by a trusted Certificate Authority (CA). This requires that a list of trusted CAs are uploaded to the system in advance.

## NetworkServices HTTPS VerifyClientCertificate

When the video system connects to a HTTPS client (like a web browser), the client can be asked to present a certificate to the video system to identify itself.

Requires user role: ADMIN

Default value: Off

Value space: Off/On

Off: Do not verify client certificates.

On: Requires the client to present a certificate that is signed by a trusted Certificate Authority (CA). This requires that a list of trusted CAs are uploaded to the system in advance.

## NetworkServices NTP Mode

The Network Time Protocol (NTP) is used to synchronize the system's time and date to a reference time server. The time server will be queried regularly for time updates.

Requires user role: ADMIN

Default value: Auto

Value space: Auto/Manual/Off

Auto: The system will use an NTP server for time reference. As default, the server address will be obtained from the network's DHCP server. If a DHCP server is not used, or if the DHCP server does not provide an NTP server address, the NTP server address that is specified in the NetworkServices NTP Server [n] Address setting will be used.

Manual: The system will use the NTP server that is specified in the NetworkServices NTP Server [n] Address setting for time reference.

Off: The system will not use an NTP server. The NetworkServices NTP Server [n] Address setting will be ignored.

## NetworkServices NTP Server [1..3] Address

The address of the NTP server that will be used when NetworkServices NTP Mode is set to Manual, and when NetworkServices NTP Mode is set to Auto and no address is supplied by a DHCP server.

Requires user role: ADMIN

Default value: "0.tandberg.pool.ntp.org"

Value space: String (0, 255)

A valid IPv4 address, IPv6 address or DNS name.

## NetworkServices SIP Mode

Define whether the system should be able to place and receive SIP calls or not.

Requires user role: ADMIN

Default value: On

Value space: Off/On

Off: Disable the possibility to place and receive SIP calls.

On: Enable the possibility to place and receive SIP calls.

## NetworkServices SNMP Mode

SNMP (Simple Network Management Protocol) is used in network management systems to monitor network-attached devices (routers, servers, switches, projectors, etc) for conditions that warrant administrative attention. SNMP exposes management data in the form of variables on the managed systems, which describe the system configuration. These variables can then be queried (set to ReadOnly) and sometimes set (set to ReadWrite) by managing applications.

Requires user role: ADMIN, INTEGRATOR

Default value: ReadOnly

Value space: Off/ReadOnly/ReadWrite

Off: Disable the SNMP network service.

ReadOnly: Enable the SNMP network service for queries only.

ReadWrite: Enable the SNMP network service for both queries and commands.

## NetworkServices SNMP Host [1..3] Address

Define the address of up to three SNMP Managers.

The system's SNMP Agent (in the codec) responds to requests from SNMP Managers (a PC program etc.), for example about system location and system contact. SNMP traps are not supported.

Requires user role: ADMIN, INTEGRATOR

Default value: ""

Value space: String (0..255)

A valid IPv4 address, IPv6 address or DNS name.

## NetworkServices SNMP CommunityName

Define the name of the Network Services SNMP Community. SNMP Community names are used to authenticate SNMP requests. SNMP requests must have a password (case sensitive) in order to receive a response from the SNMP Agent in the codec. The default password is "public". If you have the Cisco TelePresence Management Suite (TMS) you must make sure the same SNMP Community is configured there too. NOTE: The SNMP Community password is case sensitive.

Requires user role: ADMIN, INTEGRATOR

Default value: ""

Value space: String (0, 50)

The SNMP community name.

## NetworkServices SNMP SystemContact

Define the name of the Network Services SNMP System Contact.

Requires user role: ADMIN, INTEGRATOR

Default value: ""

Value space: String (0, 50)

The name of the SNMP system contact.



## NetworkServices SNMP SystemLocation

Define the name of the Network Services SNMP System Location.

Requires user role: ADMIN, INTEGRATOR

Default value: ""

Value space: String (0, 50)

The name of the SNMP system location.

## NetworkServices SSH Mode

SSH (or Secure Shell) protocol can provide secure encrypted communication between the codec and your local computer.

Requires user role: ADMIN

Default value: On

Value space: Off/On

Off: The SSH protocol is disabled.

On: The SSH protocol is enabled.

## NetworkServices SSH HostKeyAlgorithm

Choose the cryptographic algorithm that shall be used for the SSH host key. Choices are RSA (Rivest-Shamir-Adleman) with 2048 bits keysize, ECDSA (Elliptic Curve Digital Signature Algorithm) with NIST curve P-384, and EdDSA (Edwards-curve Digital Signature Algorithm) with ed25519 signature schema.

Requires user role: ADMIN

Default value: RSA

Value space: ECDSA/RSA/ed25519

ECDSA: Use the ECDSA algorithm (nist-384p).

RSA: Use the RSA algorithm (2048 bits).

ed25519: Use the ed25519 algorithm.

## NetworkServices SSH AllowPublicKey

Secure Shell (SSH) public key authentication can be used to access the codec.

Requires user role: ADMIN

Default value: On

Value space: Off/On

Off: The SSH public key is not allowed.

On: The SSH public key is allowed.

## NetworkServices UPnP Mode

Fully disable UPnP (Universal Plug and Play), or enable UPnP for a short time period after the video system has been switched on or restarted.

The default operation is that UPnP is enabled when you switch on or restart the video system. Then UPnP is automatically disabled after the timeout period that is defined in the NetworkServices UPnP Timeout setting. Use the video system's web interface to set the timeout.

When UPnP is enabled, the video system advertises its presence on the network. The advertisement permits a Touch controller to discover video systems automatically, and you do not need to manually enter the video system's IP address in order to pair the Touch controller.

Requires user role: ADMIN

Default value: On

Value space: Off/On

Off: UPnP is disabled. The video system does not advertise its presence, and you have to enter the video system's IP address manually in order to pair a Touch controller to the video system.

On: UPnP is enabled. The video system advertises its presence until the timeout period expires.

## NetworkServices UPnP Timeout

Define for how many seconds UPnP shall stay enabled after the video system is switched on or restarted. The NetworkServices UPnP Mode setting must be On for this setting to take any effect.

Requires user role: ADMIN

Default value: 600

Value space: Integer (0..3600)

Range: Select a value between 0 and 3600 seconds.

## NetworkServices WelcomeText

Choose which information the user should see when logging on to the codec through SSH.

Requires user role: ADMIN

Default value: On

Value space: Off/On

Off: The welcome text is: Login successful

On: The welcome text is: Welcome to <system name>; Software version; Software release date; Login successful.

## NetworkServices Wifi Allowed

Video systems that have a built-in Wi-Fi adapter, can connect to the network either via Ethernet or Wi-Fi. Both Ethernet and Wi-Fi are allowed by default, and the user can choose which one to use from the user interface. With this setting, the administrator can disable Wi-Fi configuration, so that it cannot be set up from the user interface.

The systems support the following standards: IEEE 802.11a, IEEE 802.11b, IEEE 802.11g, IEEE 802.11n, and IEEE 802.11ac. The system supports the following security protocols: WPA-PSK (AES), WPA2-PSK (AES), EAP-TLS, EAP-TTLS, EAP-FAST, PEAP, EAP-MSCHAPv2, EAP-GTC, and open networks (not secured).

If the PID (Product ID), found on the rating label at the rear of the video system, contains the letters NR (No Radio) the system does not support Wi-Fi.

Requires user role: ADMIN, USER

Default value: True

Value space: False/True

False: Wi-Fi cannot be used. You must connect to the network via Ethernet.

True: Both Ethernet and Wi-Fi are allowed.

## NetworkServices Wifi Enabled

Provided that the video system is allowed to connect to the network via Wi-Fi (see the NetworkServices WIFI Allowed setting), you can use this setting to enable and disable Wi-Fi.

You cannot use Ethernet and Wi-Fi at the same time. If you try to configure Wi-Fi while an Ethernet cable is connected, you must unplug the Ethernet cable to proceed. If you connect an Ethernet cable while connected to Wi-Fi, Ethernet will take precedence. If you unplug the Ethernet cable, the video system will automatically connect to the last connected Wi-Fi network, if available.

Requires user role: ADMIN, USER

Default value: True

Value space: False/True

False: Wi-Fi is disabled.

True: Wi-Fi is enabled.

## NetworkServices XMLAPI Mode

Enable or disable the video system's XML API. For security reasons this may be disabled. Disabling the XML API will limit the remote manageability with for example TMS, which no longer will be able to connect to the video system.

Requires user role: ADMIN

Default value: On

Value space: Off/On

Off: The XML API is disabled.

On: The XML API is enabled.

## Peripherals settings

### Peripherals InputDevice Mode

Define whether or not to allow the use of a third-party USB keyboard or remote control for video system control.

This is included as a preview feature in CE9.5.

Requires user role: ADMIN

Default value: Off

Value space: Off/On

Off: A third-party USB keyboard or remote control is not allowed.

On: A third-party USB keyboard or remote control can be used to control the video system.

### Peripherals Pairing CiscoTouchPanels EmcResilience

If the Touch controller is used in environments with considerable amounts of electromagnetic noise present, you may experience an appearance of false signals—for example as if someone tapped the Touch controller when obviously nobody did so. To cope with this you may enable the EMC Resilience Mode.

Requires user role: ADMIN

Default value: Off

Value space: Off/On

Off: The EMC resilience is disabled.

On: The EMC resilience is enabled.

### Peripherals Profile Cameras

Define the number of cameras that are expected to be connected to the video system. This information is used by the video system's diagnostics service. If the number of connected cameras does not match this setting, the diagnostics service will report it as an inconsistency.

Requires user role: ADMIN, INTEGRATOR

Default value: Minimum1

Value space: NotSet/Minimum1/0/1/2/3/4/5/6/7

NotSet: No camera check is performed.

Minimum1: At least one camera should be connected to the video system.

0-7: Select the number of cameras that are expected to be connected to the video system.

### Peripherals Profile ControlSystems

Define if a third-party control system, for example Crestron or AMX, is expected to be connected to the video system. This information is used by the video system's diagnostics service. If the number of connected control systems does not match this setting, the diagnostics service will report it as an inconsistency. Note that only one third-party control system is supported.

If set to 1, the control system must send heart beats to the video system using xCommand Peripherals Pair and HeartBeat commands. Failing to do so will cause the in-room control extensions to show a warning that the video system has lost connectivity to the control system.

Requires user role: ADMIN, INTEGRATOR

Default value: NotSet

Value space: 1/NotSet

1: One third-party control system should be connected to the video system.

NotSet: No check for a third-party control system is performed.

## Peripherals Profile TouchPanels

Define the number of Cisco Touch controllers that are expected to be connected to the video system. This information is used by the video system's diagnostics service. If the number of connected Touch controllers does not match this setting, the diagnostics service will report it as an inconsistency.

Requires user role: ADMIN, INTEGRATOR

Default value: Minimum1

Value space: NotSet/Minimum1/0/1/2/3/4/5

NotSet: No touch panel check is performed.

Minimum1: At least one Cisco Touch controller should be connected to the video system.

0-5: Select the number of Touch controllers that are expected to be connected to the video system. Note that only one Cisco Touch controller is officially supported.

## Phonebook settings

### Phonebook Server [1..1] ID

Define a name for the external phone book.

Requires user role: ADMIN

Default value: ""

Value space: String (0, 64)

The name for the external phone book.

### Phonebook Server [1..1] Type

Select the phonebook server type.

Requires user role: ADMIN

Default value: Off

Value space: Off/CUCM/Spark/TMS/VCS

Off: Do not use a phonebook.

CUCM: The phonebook is located on the Cisco Unified Communications Manager.

Spark: The phonebook is located in the Cisco Webex cloud service.

TMS: The phonebook is located on the Cisco TelePresence Management Suite server.

VCS: The phonebook is located on the Cisco TelePresence Video Communication Server.

### Phonebook Server [1..1] URL

Define the address (URL) to the external phone book server.

Requires user role: ADMIN

Default value: ""

Value space: String (0..255)

A valid address (URL) to the phone book server.

## Provisioning settings

### Provisioning Connectivity

This setting controls how the device discovers whether it should request an internal or external configuration from the provisioning server.

Requires user role: ADMIN, USER

Default value: Auto

Value space: Internal/External/Auto

Internal: Request internal configuration.

External: Request external configuration.

Auto: Automatically discover using NAPTR queries whether internal or external configurations should be requested. If the NAPTR responses have the "e" flag, external configurations will be requested. Otherwise internal configurations will be requested.

### Provisioning ExternalManager Address

Define the IP Address or DNS name of the external manager / provisioning system.

If an External Manager Address (and Path) is configured, the system will send a message to this address when starting up. When receiving this message the external manager / provisioning system can return configurations/commands to the unit as a result.

When using CUCM or TMS provisioning, the DHCP server can be set up to provide the external manager address automatically (DHCP Option 242 for TMS, and DHCP Option 150 for CUCM). An address set in the Provisioning ExternalManager Address setting will override the address provided by DHCP.

Requires user role: ADMIN, USER

Default value: ""

Value space: String (0, 64)

A valid IPv4 address, IPv6 address or DNS name.

### Provisioning ExternalManager AlternateAddress

Only applicable when the endpoint is provisioned by Cisco Unified Communication Manager (CUCM) and an alternate CUCM is available for redundancy. Define the address of the alternate CUCM. If the main CUCM is not available, the endpoint will be provisioned by the alternate CUCM. When the main CUCM is available again, the endpoint will be provisioned by this CUCM.

Requires user role: ADMIN, USER

Default value: ""

Value space: String (0, 64)

A valid IPv4 address, IPv6 address or DNS name.

### Provisioning ExternalManager Protocol

Define whether to use the HTTP (unsecure communication) or HTTPS (secure communication) protocol when sending requests to the external manager / provisioning system.

The selected protocol must be enabled in the NetworkServices HTTP Mode setting.

Requires user role: ADMIN, USER

Default value: HTTP

Value space: HTTPS/HTTP

HTTPS: Send requests via HTTPS.

HTTP: Send requests via HTTP.

## Provisioning ExternalManager Path

Define the Path to the external manager / provisioning system. This setting is required when several management services reside on the same server, i.e. share the same External Manager address.

Requires user role: ADMIN, USER

Default value: ""

Value space: String (0..255)

A valid path to the external manager or provisioning system.

## Provisioning ExternalManager Domain

Define the SIP domain for the VCS provisioning server.

Requires user role: ADMIN, USER

Default value: ""

Value space: String (0, 64)

A valid domain name.

## Provisioning Mode

It is possible to configure a video system using a provisioning system (external manager). This allows video conferencing network administrators to manage many video systems simultaneously. With this setting you choose which type of provisioning system to use. Provisioning can also be switched off. Contact your provisioning system provider/ representative for more information.

Requires user role: ADMIN, USER

Default value: Auto

Value space: Off/Auto/CUCM/Edge/Spark/TMS/VCS

Off: The video system is not configured by a provisioning system.

Auto: The provisioning server is automatically selected as set up in the DHCP server.

CUCM: Push configurations to the video system from CUCM (Cisco Unified Communications Manager).

Edge: Push configurations to the video system from CUCM (Cisco Unified Communications Manager). The system connects to CUCM via the Collaboration Edge infrastructure. In order to register over Edge the encryption option key must be installed on the video system.

Spark: Push configurations to the video system from the Cisco Webex cloud service.

TMS: Push configurations to the video system from TMS (Cisco TelePresence Management System).

VCS: Push configurations to the video system from VCS (Cisco TelePresence Video Communication Server).

## Provisioning LoginName

This is the username part of the credentials used to authenticate the video system with the provisioning server. This setting must be used when required by the provisioning server.

Requires user role: ADMIN, USER

Default value: ""

Value space: String (0, 80)

A valid username.



## Provisioning Password

This is the password part of the credentials used to authenticate the video system with the provisioning server. This setting must be used when required by the provisioning server.

Requires user role: ADMIN, USER

Default value: ""

Value space: String (0, 64)

A valid password.

## Proximity settings

### Proximity Mode

Determine whether the video system will emit ultrasound pairing messages or not.

When the video system emits ultrasound, Proximity clients can detect that they are close to the video system. In order to use a client, at least one of the Proximity services must be enabled (refer to the Proximity Services settings). In general, Cisco recommends enabling all the Proximity services.

Requires user role: ADMIN, USER

Default value: Off

Value space: Off/On

Off: The video system does not emit ultrasound, and Proximity services cannot be used.

On: The video system emits ultrasound, and Proximity clients can detect that they are close to the video system. Enabled Proximity services can be used.

### Proximity Services CallControl

Enable or disable basic call control features on Proximity clients. When this setting is enabled, you are able to control a call using a Proximity client (for example dial, mute, adjust volume and hang up). This service is supported by mobile devices (iOS and Android). Proximity Mode must be On for this setting to take any effect.

Requires user role: ADMIN, USER

Default value: Disabled

Value space: Enabled/Disabled

Enabled: Call control from a Proximity client is enabled.

Disabled: Call control from a Proximity client is disabled.

### Proximity Services ContentShare FromClients

Enable or disable content sharing from Proximity clients. When this setting is enabled, you can share content from a Proximity client wirelessly on the video system, e.g. share your laptop screen. This service is supported by laptops (OS X and Windows). Proximity Mode must be On for this setting to take any effect.

Requires user role: ADMIN, USER

Default value: Enabled

Value space: Enabled/Disabled

Enabled: Content sharing from a Proximity client is enabled.

Disabled: Content sharing from a Proximity client is disabled.

### Proximity Services ContentShare ToClients

Enable or disable content sharing to Proximity clients. When enabled, Proximity clients will receive the presentation from the video system. You can zoom in on details, view previous content and take snapshots. This service is supported by mobile devices (iOS and Android). Proximity Mode must be On for this setting to take any effect.

Requires user role: ADMIN, USER

Default value: Disabled

Value space: Enabled/Disabled

Enabled: Content sharing to a Proximity client is enabled.

Disabled: Content sharing to a Proximity client is disabled.

## RoomAnalytics settings

### RoomAnalytics PeopleCountOutOfCall

By using face detection, the video system – when a Cisco Quad Camera is connected – has the capability to find how many persons are in the room. By default, the system only counts people when in a call, or when displaying the self-view picture.

Requires user role: ADMIN, INTEGRATOR, USER

Default value: Off

Value space: Off/On

Off: The video system counts people only when the system is in a call, or when self-view is on.

On: The video system counts people as long as the video system is not in standby mode. This includes outside of call, even if self-view is off.

### RoomAnalytics PeoplePresenceDetector

The video system has the capability to find whether or not people are present in the room, and report the result in the RoomAnalytics PeoplePresence status. This feature is based on ultrasound. It takes a minimum of 2 minutes to detect whether people are present or not in the room, and it may take up to 2 minutes for the status to change after the room becomes vacant.

Requires user role: ADMIN, INTEGRATOR, USER

Default value: Off

Value space: Off/On

Off: The video system's status does not show whether or not there are people present in the room.

On: The video system's status shows whether or not there are people present in the room.

## RoomReset settings

### RoomReset Control

This setting is for use with control systems or macros. Macros allow you to write snippets of JavaScript code that can automate parts of your video endpoint, thus creating custom behavior.

When a room has been idle for some time the system can send an event to indicate that the room is ready to be reset.

The events that are sent when this setting is enabled are:

```
*e RoomReset SecondsToReset: 30
** end
*e RoomReset Reset
** end
```

Requires user role: ADMIN

Default value: On

Value space: CameraPositionsOnly/Off/On

CameraPositionsOnly: Not applicable.

Off: No RoomReset events will be sent.

On: The room reset control is enabled and RoomReset events will be sent.

## RTP settings

### RTP Ports Range Start

Define the first port in the range of RTP ports.

As default, the system is using the ports in the range 2326 to 2486 for RTP and RTCP media data. The minimum range is 100 when RTP Video Ports Range is disabled, and 20 when RTP Video Ports Range is enabled.

If the RTP Video Ports Range is enabled, audio will use the range defined by the RTP Ports Range settings, and other media data will use the range defined by the RTP Video Ports Range settings. The two ranges must not overlap.

A change in the setting will take effect on new calls.

Requires user role: ADMIN

Default value: 2326

Value space: Integer (1024..65438)

Set the first port in the range of RTP ports.

### RTP Ports Range Stop

Define the last port in the range of RTP ports.

As default, the system is using the ports in the range 2326 to 2487 for RTP and RTCP media data. If the RTP Video Ports Range is enabled the system is using the ports in the range 1024 to 65436. The minimum range is 100 when RTP Video Ports Range is disabled, and 20 when RTP Video Ports Range is enabled.

If the RTP Video Ports Range is enabled, audio will use the range defined by the RTP Ports Range settings, and other media data will use the range defined by the RTP Video Ports Range settings. The two ranges must not overlap.

A change in the setting will take effect on new calls.

Requires user role: ADMIN

Default value: 2486

Value space: Integer (1120..65535)

Set the last port in the range of RTP ports.

### RTP Video Ports Range Start

Define the first port in the range of RTP video ports.

If both the start and stop values are set to 0, the RTP Video Ports Range is disabled. To enable it, set the first port to a value between 1024 and 65454 and the last port between 1024 and 65535. The minimum range is 80.

If the RTP Video Ports Range is enabled, audio will use the range defined by the RTP Ports Range settings, and other media data will use the range defined by the RTP Video Ports Range settings. The two ranges must not overlap.

A change in the setting will take effect on new calls.

Requires user role: ADMIN

Default value: 0

Value space: Integer (0, 1024..65454)

Set the first port in the range of RTP video ports.

### RTP Video Ports Range Stop

Define the last port in the range of RTP video ports.

If both the start and stop values are set to 0, the RTP Video Ports Range is disabled. To enable it, set the first port to a value between 1024 and 65454 and the last port between 1024 and 65535. The minimum range is 80.

If the RTP Video Ports Range is enabled, audio will use the range defined by the RTP Ports Range settings, and other media data will use the range defined by the RTP Video Ports Range settings. The two ranges must not overlap.

A change in the setting will take effect on new calls.

Requires user role: ADMIN

Default value: 0

Value space: Integer (0, 1024..65535)

Set the last port in the range of RTP video ports.

## Security settings

### Security Audit Logging Mode

Define where to record or transmit the audit logs. The audit logs are sent to a syslog server. When using the External/ExternalSecure modes and setting the port assignment to manual in the Security Audit Server PortAssignment setting, you must also enter the address and port number for the audit server in the Security Audit Server Address and Security Audit Server Port settings.

Requires user role: AUDIT

Default value: Internal

Value space: External/ExternalSecure/Internal/Off

External: The system sends the audit logs to an external syslog server. The syslog server must support UDP.

ExternalSecure: The system sends encrypted audit logs to an external syslog server that is verified by a certificate in the Audit CA list. The Audit CA list file must be uploaded to the codec using the web interface. The common\_name parameter of a certificate in the CA list must match the IP address of the syslog server, and the secure TCP server must be set up to listen for secure (TLS) TCP Syslog messages.

Internal: The system records the audit logs to internal logs, and rotates logs when they are full.

Off: No audit logging is performed.

### Security Audit OnError Action

Define what happens when the connection to the syslog server is lost. This setting is only relevant when Security Audit Logging Mode is set to ExternalSecure.

Requires user role: AUDIT

Default value: Ignore

Value space: Halt/Ignore

Halt: If a halt condition is detected the system codec is rebooted and only the auditor is allowed to operate the unit until the halt condition has passed. When the halt condition has passed the audit logs are re-spooled to the syslog server. Halt conditions are: A network breach (no physical link), no syslog server running (or incorrect address or port to the syslog server), TLS authentication failed (if in use), local backup (re-spooling) log full.

Ignore: The system will continue its normal operation, and rotate internal logs when full. When the connection is restored it will again send its audit logs to the syslog server.

### Security Audit Server Address

The audit logs are sent to a syslog server. Define the IP address of the syslog server. Only valid IPv4 or IPv6 address formats are accepted. Host names are not supported. This setting is only relevant when Security Audit Logging Mode is set to External or ExternalSecure.

Requires user role: AUDIT

Default value: ""

Value space: String (0..255)

A valid IPv4 address or IPv6 address

## Security Audit Server Port

The audit logs are sent to a syslog server. Define the port of the syslog server that the system shall send its audit logs to. This setting is only relevant when Security Audit Server PortAssignment is set to Manual.

Requires user role: AUDIT

Default value: 514

Value space: Integer (0..65535)

Set the audit server port.

## Security Audit Server PortAssignment

The audit logs are sent to a syslog server. You can define how the port number of the external syslog server will be assigned. This setting is only relevant when Security Audit Logging Mode is set to External or ExternalSecure. To see which port number is used you can check the Security Audit Server Port status. Navigate to Setup > Status on the web interface or; if on a command line interface, run the command xStatus Security Audit Server Port.

Requires user role: AUDIT

Default value: Auto

Value space: Auto/Manual

Auto: Will use UDP port number 514 when the Security Audit Logging Mode is set to External. Will use TCP port number 6514 when the Security Audit Logging Mode is set to ExternalSecure.

Manual: Will use the port value defined in the Security Audit Server Port setting.

## Security Session FailedLoginsLockoutTime

Define how long the system will lock out a user after failed login to a web or SSH session.

Restart the system for any change to this setting to take effect.

Requires user role: ADMIN

Default value: 60

Value space: Integer (0..10000)

Set the lockout time (minutes).

## Security Session InactivityTimeout

Define how long the system will accept inactivity from the user before he is automatically logged out from a web or SSH session.

Restart the system for any change to this setting to take effect.

Requires user role: ADMIN

Default value: 0

Value space: Integer (0..10000)

Set the inactivity timeout (minutes); or select 0 when inactivity should not enforce automatic logout.

## Security Session MaxFailedLogins

Define the maximum number of failed login attempts per user for a web or SSH session. If the user exceeded the maximum number of attempts the user will be locked out. 0 means that there is no limit for failed logins.

Restart the system for any change to this setting to take effect.

Requires user role: ADMIN

Default value: 0

Value space: Integer (0..10)

Set the maximum number of failed login attempts per user.

## Security Session MaxSessionsPerUser

The maximum number of simultaneous sessions per user is 20 sessions.

Requires user role: ADMIN

Default value: 20

Value space: Integer (1..20)

Set the maximum number of simultaneous sessions per user.

## Security Session MaxTotalSessions

The maximum number of simultaneous sessions in total is 20 sessions.

Requires user role: ADMIN

Default value: 20

Value space: Integer (1..20)

Set the maximum number of simultaneous sessions in total.

## Security Session ShowLastLogon

When logging in to the system using SSH you will see the UserId, time and date of the last session that did a successful login.

Requires user role: ADMIN

Default value: Off

Value space: Off/On

On: Show information about the last session.

Off: Do not show information about the last session.



## SerialPort settings

### SerialPort Mode

Enable/disable the serial port.

Requires user role: ADMIN, INTEGRATOR

Default value: On

Value space: Off/On

Off: Disable the serial port.

On: Enable the serial port.

### SerialPort BaudRate

Set the baud rate (data transmission rate, bits per second) for the serial port.

Other connection parameters for the serial port are: Data bits: 8; Parity: None; Stop bits: 1; Flow control: None.

Requires user role: ADMIN, INTEGRATOR

Default value: 115200

Value space: 115200

Choose a baud rate from the baud rates listed (bps).

### SerialPort LoginRequired

Define if login shall be required when connecting to the serial port.

Requires user role: ADMIN

Default value: On

Value space: Off/On

Off: The user can access the codec via the serial port without any login.

On: Login is required when connecting to the codec via the serial port.

## SIP settings

### SIP ANAT

ANAT (Alternative Network Address Types) enables media negotiation for multiple addresses and address types, as specified in RFC 4091.

Requires user role: ADMIN

Default value: Off

Value space: Off/On

Off: Disable ANAT.

On: Enable ANAT.

### SIP Authentication UserName

This is the user name part of the credentials used to authenticate towards the SIP proxy.

Requires user role: ADMIN

Default value: ""

Value space: String (0, 128)

A valid username.

### SIP Authentication Password

This is the password part of the credentials used to authenticate towards the SIP proxy.

Requires user role: ADMIN

Default value: ""

Value space: String (0, 128)

A valid password.

### SIP DefaultTransport

Select the transport protocol to be used over the LAN.

Requires user role: ADMIN

Default value: Auto

Value space: Auto/TCP/Tls/UDP

TCP: The system will always use TCP as the default transport method.

UDP: The system will always use UDP as the default transport method.

Tls: The system will always use TLS as the default transport method. For TLS connections a SIP CA-list can be uploaded to the video system. If no such CA-list is available on the system then anonymous Diffie Hellman will be used.

Auto: The system will try to connect using transport protocols in the following order: TLS, TCP, UDP.

### SIP DisplayName

When configured the incoming call will report the display name instead of the SIP URI.

Requires user role: ADMIN

Default value: ""

Value space: String (0, 550)

The name to be displayed instead of the SIP URI.

## SIP Ice DefaultCandidate

The ICE protocol needs some time to reach a conclusion about which media route to use (up to the first 5 seconds of a call). During this period media for the video system will be sent to the Default Candidate as defined in this setting.

Requires user role: ADMIN

Default value: Host

Value space: Host/Rflx/Relay

Host: Send media to the video system's private IP address.

Rflx: Send media to the video system's public IP address, as seen by the TURN server.

Relay: Send media to the IP address and port allocated on the TURN server.

## SIP Ice Mode

ICE (Interactive Connectivity Establishment, RFC 5245) is a NAT traversal solution that the video systems can use to discover the optimized media path. Thus the shortest route for audio and video is always secured between the video systems.

Requires user role: ADMIN

Default value: Auto

Value space: Auto/Off/On

Auto: ICE is enabled if a TURN server is provided, otherwise ICE is disabled.

Off: ICE is disabled.

On: ICE is enabled.

## SIP Line

When registered to a Cisco Unified Communications Manager (CUCM) the endpoint may be part of a shared line. This means that several devices share the same directory number. The different devices sharing the same number receive status from the other appearances on the line as defined in RFC 4235.

Note that shared lines are set up by CUCM, not by the endpoint. Therefore do not change this setting manually; CUCM pushes this information to the endpoint when required.

Requires user role: ADMIN

Default value: Private

Value space: Private/Shared

Shared: The system is part of a shared line and is therefore sharing its directory number with other devices.

Private: This system is not part of a shared line.

## SIP ListenPort

Turn on or off the listening for incoming connections on the SIP TCP/UDP ports. If turned off, the endpoint will only be reachable through the SIP registrar (CUCM or VCS).

Requires user role: ADMIN

Default value: On

Value space: Off/On

Off: Listening for incoming connections on the SIP TCP/UDP ports is turned off.

On: Listening for incoming connections on the SIP TCP/UDP ports is turned on.

## SIP Mailbox

When registered to a Cisco Unified Communications Manager (CUCM) you may be offered the option of having a private voice mailbox.

Requires user role: ADMIN

Default value: ""

Value space: String (0, 255)

A valid number or address. Leave the string empty if you do not have a voice mailbox.

## SIP MinimumTLSVersion

Set the lowest version of the TLS (Transport Layer Security) protocol that is allowed.

Requires user role: ADMIN

Default value: TLSv1.0

Value space: TLSv1.0/TLSv1.1/TLSv1.2

TLSv1.0: Support TLS version 1.0 or higher.

TLSv1.1: Support TLS version 1.1 or higher.

TLSv1.2: Support TLS version 1.2 or higher.

## SIP PreferredIPMedia

Define the preferred IP version for sending and receiving media (audio, video, data). Only applicable when both Network IPStack and Conference CallProtocolIPStack are set to Dual, and the network does not have a mechanism for choosing the preferred IP version.

Requires user role: ADMIN

Default value: IPv4

Value space: IPv4/IPv6

IPv4: The preferred IP version for media is IPv4.

IPv6: The preferred IP version for media is IPv6.

## SIP PreferredIPSignaling

Define the preferred IP version for signaling (audio, video, data). Only applicable when both Network IPStack and Conference CallProtocolIPStack are set to Dual, and the network does not have a mechanism for choosing the preferred IP version. It also determines the priority of the A/AAAA lookups in DNS, so that the preferred IP version is used for registration.

Requires user role: ADMIN

Default value: IPv4

Value space: IPv4/IPv6

IPv4: The preferred IP version for signaling is IPv4.

IPv6: The preferred IP version for signaling is IPv6.

## SIP Proxy [1..4] Address

The Proxy Address is the manually configured address for the outbound proxy. It is possible to use a fully qualified domain name, or an IP address. The default port is 5060 for TCP and UDP but another one can be provided.

Requires user role: ADMIN

Default value: ""

Value space: String (0..255)

A valid IPv4 address, IPv6 address or DNS name.

## SIP TlsVerify

For TLS connections a SIP CA-list can be uploaded to the video system. This can be done from the web interface.

Requires user role: ADMIN

Default value: Off

Value space: Off/On

Off: Set to Off to allow TLS connections without verifying them. The TLS connections are allowed to be set up without verifying the x.509 certificate received from the server against the local CA-list. This should typically be selected if no SIP CA-list has been uploaded.

On: Set to On to verify TLS connections. Only TLS connections to servers, whose x.509 certificate is validated against the CA-list, will be allowed.

## SIP Turn DiscoverMode

Define the discover mode to enable/disable the application to search for available Turn servers in DNS. Before making calls, the system will test if port allocation is possible.

Requires user role: ADMIN

Default value: On

Value space: Off/On

Off: Set to Off to disable discovery mode.

On: When set to On, the system will search for available Turn servers in DNS, and before making calls the system will test if port allocation is possible.

## SIP Turn DropRflx

DropRflx will make the endpoint force media through the Turn relay, unless the remote endpoint is on the same network.

Requires user role: ADMIN

Default value: Off

Value space: Off/On

Off: Disable DropRflx.

On: The system will force media through the Turn relay when the remote endpoint is on another network.

## SIP Turn Server

Define the address of the TURN (Traversal Using Relay NAT) server. It is used as a media relay fallback and it is also used to discover the endpoint's own public IP address.

Requires user role: ADMIN

Default value: ""

Value space: String (0..255)

The preferred format is DNS SRV record (e.g. `_turn._udp.<domain>`), or it can be a valid IPv4 or IPv6 address.

## SIP Turn UserName

Define the user name needed for accessing the TURN server.

Requires user role: ADMIN

Default value: ""

Value space: String (0, 128)

A valid user name.

## SIP Turn Password

Define the password needed for accessing the TURN server.

Requires user role: ADMIN

Default value: ""

Value space: String (0, 128)

A valid password.

## SIP Type

Enables SIP extensions and special behavior for a vendor or provider.

Requires user role: ADMIN

Default value: Standard

Value space: Standard/Cisco

Standard: Use this when registering to standard SIP Proxy (tested with Cisco TelePresence VCS).

Cisco: Use this when registering to Cisco Unified Communication Manager.

## SIP URI

The SIP URI (Uniform Resource Identifier) is the address that is used to identify the video system. The URI is registered and used by the SIP services to route inbound calls to the system. The SIP URI syntax is defined in RFC 3261.

Requires user role: ADMIN

Default value: ""

Value space: String (0..255)

An address (URI) that is compliant with the SIP URI syntax.

## Standby settings

### Standby BootAction

Define the camera position after a restart of the codec.

Requires user role: ADMIN, INTEGRATOR, USER

Default value: DefaultCameraPosition

Value space: None/DefaultCameraPosition/RestoreCameraPosition

None: No action.

RestoreCameraPosition: When the video system restarts, the camera returns to the position that it had before the restart.

DefaultCameraPosition: When the video system restarts, the camera moves to the factory default position.

### Standby Control

Define whether the system should go into standby mode or not.

Requires user role: ADMIN, INTEGRATOR

Default value: On

Value space: Off/On

Off: The system will not enter standby mode.

On: The system will enter standby mode when the Standby Delay has timed out.  
Requires the Standby Delay to be set to an appropriate value.

### Standby Delay

Define how long (in minutes) the system shall be in idle mode before it goes into standby mode. Requires the Standby Control to be enabled.

Requires user role: ADMIN, INTEGRATOR

Default value: 10

Value space: Integer (1..480)

Set the standby delay (minutes).

### Standby StandbyAction

Define the camera position when going into standby mode.

Requires user role: ADMIN, INTEGRATOR

Default value: PrivacyPosition

Value space: None/PrivacyPosition

None: No action.

PrivacyPosition: When the video system enters standby, the camera turns to a sideways position for privacy.

### Standby WakeupAction

Define the camera position when leaving standby mode.

Requires user role: ADMIN, INTEGRATOR, USER

Default value: RestoreCameraPosition

Value space: None/RestoreCameraPosition/DefaultCameraPosition

None: No action.

RestoreCameraPosition: When the video system leaves standby, the camera returns to the position that it had before entering standby.

DefaultCameraPosition: When the video system leaves standby, the camera moves to the factory default position.

### Standby WakeupOnMotionDetection

Automatic wake up on motion detection is a feature that will sense when a person walks into the room. The feature is based on ultrasound detection, and the Proximity Mode setting must be On to make the feature work.

Requires user role: ADMIN, INTEGRATOR

Default value: Off

Value space: Off/On

Off: The wake up on motion detection is disabled.

On: When people walk into the room the system will automatically wake up from standby.

## SystemUnit settings

### SystemUnit Name

Define the system name. The system name will be sent as the hostname in a DHCP request and when the codec is acting as an SNMP Agent.

Requires user role: ADMIN

Default value: ""

Value space: String (0, 50)

Define the system name.

### SystemUnit CrashReporting Url

If the video system (codec) crashes, the system can automatically send logs to the Cisco Automatic Crash Report tool (ACR) for analyses. The ACR tool is for Cisco internal usage only and not available to customers.

Requires user role: ADMIN

Default value: "acr.cisco.com"

Value space: String (0..255)

The URL to the Cisco Automatic Crash Report tool (ACR).

### SystemUnit CrashReporting Advanced

If the video system (codec) crashes, the system can automatically send logs to the Cisco Automatic Crash Report tool (ACR) for analyses. The ACR tool is for Cisco internal usage only and not available to customers.

Requires user role: ADMIN

Default value: On

Value space: Off/On

Off: The ACR tool will perform standard log analyses.

On: The ACR tool will perform advanced log analyses.

### SystemUnit CrashReporting Mode

If the video system (codec) crashes, the system can automatically send logs to the Cisco Automatic Crash Report tool (ACR) for analyses. The ACR tool is for Cisco internal usage only and not available to customers.

Requires user role: ADMIN

Default value: On

Value space: Off/On

Off: No logs will be sent to ACR tool.

On: The logs will automatically be sent to ACR tool.

## Time settings

### Time TimeFormat

Define the time format.

Requires user role: ADMIN, USER

Default value: 24H

Value space: 24H/12H

24H: Set the time format to 24 hours.

12H: Set the time format to 12 hours (AM/PM).

### Time DateFormat

Define the date format.

Requires user role: ADMIN, USER

Default value: DD\_MM\_YY

Value space: DD\_MM\_YY/MM\_DD\_YY/YY\_MM\_DD

DD\_MM\_YY: The date January 30th 2010 will be displayed: 30.01.10

MM\_DD\_YY: The date January 30th 2010 will be displayed: 01.30.10

YY\_MM\_DD: The date January 30th 2010 will be displayed: 10.01.30



## Time Zone

Define the time zone for the geographical location of the video system. The information in the value space is from the tz database, also called the IANA Time Zone Database.

Requires user role: ADMIN, INTEGRATOR, USER

Default value: Etc/UTC

Value space: Africa/Abidjan, Africa/Accra, Africa/Addis\_Ababa, Africa/Algiers, Africa/Asmara, Africa/Asmera, Africa/Bamako, Africa/Bangui, Africa/Banjul, Africa/Bissau, Africa/Blantyre, Africa/Brazzaville, Africa/Bujumbura, Africa/Cairo, Africa/Casablanca, Africa/Ceuta, Africa/Conakry, Africa/Dakar, Africa/Dar\_es\_Salaam, Africa/Djibouti, Africa/Douala, Africa/EL\_Aaiun, Africa/Freetown, Africa/Gaborone, Africa/Harare, Africa/Johannesburg, Africa/Juba, Africa/Kampala, Africa/Khartoum, Africa/Kigali, Africa/Kinshasa, Africa/Lagos, Africa/Libreville, Africa/Lome, Africa/Luanda, Africa/Lubumbashi, Africa/Lusaka, Africa/Malabo, Africa/Maputo, Africa/Maseru, Africa/Mbabane, Africa/Mogadishu, Africa/Monrovia, Africa/Nairobi, Africa/Ndjamena, Africa/Niamey, Africa/Nouakchott, Africa/Ouagadougou, Africa/Porto-Novo, Africa/Sao\_Tome, Africa/Timbuktu, Africa/Tripoli, Africa/Tunis, Africa/Windhoek, America/Adak, America/Anchorage, America/Anguilla, America/Antigua, America/Araguaina, America/Argentina/Buenos\_Aires, America/Argentina/Catamarca, America/Argentina/ComodRivadavia, America/Argentina/Cordoba, America/Argentina/Jujuy, America/Argentina/La\_Rioja, America/Argentina/Mendoza, America/Argentina/Rio\_Gallegos, America/Argentina/Salta, America/Argentina/San\_Juan, America/Argentina/San\_Luis, America/Argentina/Tucuman, America/Argentina/Ushuaia, America/Aruba, America/Asuncion, America/Atikokan, America/Atka, America/Bahia, America/Bahia\_Banderas, America/Barbados, America/Belem, America/Belize, America/Blanc-Sablon, America/Boa\_Vista, America/Bogota, America/Boise, America/Buenos\_Aires, America/Cambridge\_Bay, America/Campo\_Grande, America/Cancun, America/Caracas, America/Catamarca, America/Cayenne, America/Cayman, America/Chicago, America/Chihuahua, America/Coral\_Harbour, America/Cordoba, America/Costa\_Rica, America/Creston, America/Cuiaba, America/Curacao, America/Danmarkshavn, America/Dawson, America/Dawson\_Creek, America/Denver, America/Detroit, America/Dominica, America/Edmonton, America/Eirunepe, America/El\_Salvador, America/Ensenada, America/Fort\_Nelson, America/Fort\_Wayne, America/Fortaleza, America/Glace\_Bay, America/Godthab, America/Goose\_Bay, America/Grand\_Turk, America/Grenada, America/Guadeloupe, America/Guatemala, America/Guayaquil, America/Guyana, America/Halifax, America/Havana, America/Hermosillo, America/Indiana/Indianapolis, America/Indiana/Knox, America/Indiana/Marengo, America/Indiana/Petersburg, America/Indiana/Tell\_City, America/Indiana/Vevay, America/Indiana/Vincennes, America/Indiana/Winamac, America/Indianapolis, America/Inuvik, America/Iqaluit, America/Jamaica, America/Jujuy, America/Juneau, America/Kentucky/Louisville, America/Kentucky/Monticello, America/Knox\_IN, America/Kralendijk, America/La\_Paz, America/Lima, America/Los\_Angeles, America/Louisville, America/Lower\_Princes, America/Maceio, America/Managua, America/Manaus, America/Marigot, America/Martinique, America/Matamoros, America/Mazatlan, America/Mendoza, America/Menominee, America/Merida, America/Metlakatla, America/Mexico\_City, America/

Miquelon, America/Moncton, America/Monterrey, America/Montevideo, America/Montreal, America/Montserrat, America/Nassau, America/New\_York, America/Nipigon, America/Nome, America/Noronha, America/North\_Dakota/Beulah, America/North\_Dakota/Center, America/North\_Dakota/New\_Salem, America/Ojinaga, America/Panama, America/Pangnirtung, America/Paramaribo, America/Phoenix, America/Port-au-Prince, America/Port\_of\_Spain, America/Porto\_Acre, America/Porto\_Velho, America/Puerto\_Rico, America/Rainy\_River, America/Rankin\_Inlet, America/Recife, America/Regina, America/Resolute, America/Rio\_Branco, America/Rosario, America/Santa\_Isabel, America/Santarem, America/Santiago, America/Santo\_Domingo, America/Sao\_Paulo, America/Scoresbysund, America/Shiprock, America/Sitka, America/St\_Barthelemy, America/St\_Johns, America/St\_Kitts, America/St\_Lucia, America/St\_Thomas, America/St\_Vincent, America/Swift\_Current, America/Tegucigalpa, America/Thule, America/Thunder\_Bay, America/Tijuana, America/Toronto, America/Tortola, America/Vancouver, America/Virgin, America/Whitehorse, America/Winnipeg, America/Yakutat, America/Yellowknife, Antarctica/Casey, Antarctica/Davis, Antarctica/DumontDUrville, Antarctica/Macquarie, Antarctica/Mawson, Antarctica/McMurdo, Antarctica/Palmer, Antarctica/Rothera, Antarctica/South\_Pole, Antarctica/Syowa, Antarctica/Troll, Antarctica/Vostok, Arctic/Longyearbyen, Asia/Aden, Asia/Almaty, Asia/Amman, Asia/Anadyr, Asia/Aqtau, Asia/Aqtobe, Asia/Ashgabat, Asia/Ashkhabad, Asia/Baghdad, Asia/Bahrain, Asia/Baku, Asia/Bangkok, Asia/Barnaul, Asia/Beirut, Asia/Bishkek, Asia/Brunei, Asia/Calcutta, Asia/Chita, Asia/Choibalsan, Asia/Chongqing, Asia/Chungking, Asia/Colombo, Asia/Dacca, Asia/Damascus, Asia/Dhaka, Asia/Dili, Asia/Dubai, Asia/Dushanbe, Asia/Gaza, Asia/Harbin, Asia/Hebron, Asia/Ho\_Chi\_Minh, Asia/Hong\_Kong, Asia/Hovd, Asia/Irkutsk, Asia/Istanbul, Asia/Jakarta, Asia/Jayapura, Asia/Jerusalem, Asia/Kabul, Asia/Kamchatka, Asia/Karachi, Asia/Kashgar, Asia/Kathmandu, Asia/Katmandu, Asia/Khandyga, Asia/Kolkata, Asia/Krasnoyarsk, Asia/Kuala\_Lumpur, Asia/Kuching, Asia/Kuwait, Asia/Macao, Asia/Macau, Asia/Magadan, Asia/Makassar, Asia/Manila, Asia/Muscat, Asia/Nicosia, Asia/Novokuznetsk, Asia/Novosibirsk, Asia/Omsk, Asia/Oral, Asia/Phnom\_Penh, Asia/Pontianak, Asia/Pyongyang, Asia/Qatar, Asia/Qyzylorda, Asia/Rangoon, Asia/Riyadh, Asia/Saigon, Asia/Sakhalin, Asia/Samarkand, Asia/Seoul, Asia/Shanghai, Asia/Singapore, Asia/Srednekolymsk, Asia/Taipei, Asia/Tashkent, Asia/Tbilisi, Asia/Tehran, Asia/Te\_Aviv, Asia/Thimbu, Asia/Thimphu, Asia/Tokyo, Asia/Tomsk, Asia/Ujung\_Pandang, Asia/Ulaanbaatar, Asia/Ulan\_Bator, Asia/Urumqi, Asia/Ust-Nera, Asia/Vientiane, Asia/Vladivostok, Asia/Yakutsk, Asia/Yekaterinburg, Asia/Yerevan, Atlantic/Azores, Atlantic/Bermuda, Atlantic/Canary, Atlantic/Cape\_Verde, Atlantic/Faeroe, Atlantic/Faroe, Atlantic/Jan\_Mayen, Atlantic/Madeira, Atlantic/Reykjavik, Atlantic/South\_Georgia, Atlantic/St\_Helena, Atlantic/Stanley, Australia/ACT, Australia/Adelaide, Australia/Brisbane, Australia/Broken\_Hill, Australia/Canberra, Australia/Currie, Australia/Darwin, Australia/Eucla, Australia/Hobart, Australia/LHI, Australia/Lindeman, Australia/Lord\_Howe, Australia/Melbourne, Australia/NSW, Australia/North, Australia/Perth, Australia/Queensland, Australia/South, Australia/Sydney, Australia/Tasmania, Australia/Victoria, Australia/West, Australia/Yancowinna, Brazil/Acre, Brazil/DeNoronha, Brazil/East, Brazil/West, CET, CST6CDT, Canada/Atlantic, Canada/Central, Canada/East-Saskatchewan, Canada/Eastern, Canada/Mountain, Canada/Newfoundland, Canada/Pacific, Canada/Saskatchewan, Canada/Yukon, Chile/Continental, Chile/EasterIsland, Cuba, EET, EST, EST5EDT, Egypt, Eire, Etc/GMT, Etc/GMT+0, Etc/GMT+1, Etc/GMT+10, Etc/GMT+11, Etc/GMT+12, Etc/GMT+2, Etc/GMT+3, Etc/

GMT+4, Etc/GMT+5, Etc/GMT+6, Etc/GMT+7, Etc/GMT+8, Etc/GMT+9, Etc/GMT-0, Etc/GMT-1, Etc/GMT-10, Etc/GMT-11, Etc/GMT-12, Etc/GMT-13, Etc/GMT-14, Etc/GMT-2, Etc/GMT-3, Etc/GMT-4, Etc/GMT-5, Etc/GMT-6, Etc/GMT-7, Etc/GMT-8, Etc/GMT-9, Etc/GMT0, Etc/Greenwich, Etc/UCT, Etc/UTC, Etc/Universal, Etc/Zulu, Europe/Amsterdam, Europe/Andorra, Europe/Astrakhan, Europe/Athens, Europe/Belfast, Europe/Belgrade, Europe/Berlin, Europe/Bratislava, Europe/Brussels, Europe/Bucharest, Europe/Budapest, Europe/Busingen, Europe/Chisinau, Europe/Copenhagen, Europe/Dublin, Europe/Gibraltar, Europe/Guernsey, Europe/Helsinki, Europe/Isle\_of\_Man, Europe/Istanbul, Europe/Jersey, Europe/Kaliningrad, Europe/Kiev, Europe/Kirov, Europe/Lisbon, Europe/Ljubljana, Europe/London, Europe/Luxembourg, Europe/Madrid, Europe/Malta, Europe/Mariehamn, Europe/Minsk, Europe/Monaco, Europe/Moscow, Europe/Nicosia, Europe/Oslo, Europe/Paris, Europe/Podgorica, Europe/Prague, Europe/Riga, Europe/Rome, Europe/Samara, Europe/San\_Marino, Europe/Sarajevo, Europe/Simferopol, Europe/Skopje, Europe/Sofia, Europe/Stockholm, Europe/Tallinn, Europe/Tirane, Europe/Tiraspol, Europe/Ulyanovsk, Europe/Uzhgorod, Europe/Vaduz, Europe/Vatican, Europe/Vienna, Europe/Vilnius, Europe/Volgograd, Europe/Warsaw, Europe/Zagreb, Europe/Zaporozhye, Europe/Zurich, GB, GB-Eire, GMT, GMT+0, GMT-0, GMT0, Greenwich, HST, Hongkong, Iceland, Indian/Antananarivo, Indian/Chagos, Indian/Christmas, Indian/Cocos, Indian/Comoro, Indian/Kerguelen, Indian/Mahe, Indian/Maldives, Indian/Mauritius, Indian/Mayotte, Indian/Reunion, Iran, Israel, Jamaica, Japan, Kwajalein, Libya, MET, MST, MST7MDT, Mexico/BajaNorte, Mexico/BajaSur, Mexico/General, NZ, NZ-CHAT, Navajo, PRC, PST8PDT, Pacific/Apia, Pacific/Auckland, Pacific/Bougainville, Pacific/Chatham, Pacific/Chuuk, Pacific/Easter, Pacific/Efate, Pacific/Enderbury, Pacific/Fakaofu, Pacific/Fiji, Pacific/Funafuti, Pacific/Galapagos, Pacific/Gambier, Pacific/Guadalcanal, Pacific/Guam, Pacific/Honolulu, Pacific/Johnston, Pacific/Kiritimati, Pacific/Kosrae, Pacific/Kwajalein, Pacific/Majuro, Pacific/Marquesas, Pacific/Midway, Pacific/Nauru, Pacific/Niue, Pacific/Norfolk, Pacific/Noumea, Pacific/Pago\_Pago, Pacific/Palau, Pacific/Pitcairn, Pacific/Pohnpei, Pacific/Ponape, Pacific/Port\_Moresby, Pacific/Rarotonga, Pacific/Saipan, Pacific/Samoa, Pacific/Tahiti, Pacific/Tarawa, Pacific/Tongatapu, Pacific/Truk, Pacific/Wake, Pacific/Wallis, Pacific/Yap, Poland, Portugal, ROC, ROK, Singapore, Turkey, UCT, US/Alaska, US/Aleutian, US/Arizona, US/Central, US/East-Indiana, US/Eastern, US/Hawaii, US/Indiana-Starke, US/Michigan, US/Mountain, US/Pacific, US/Pacific-New, US/Samoa, UTC, Universal, W-SU, WET, Zulu

Select a time zone from the list.

## UserInterface settings

### UserInterface Accessibility IncomingCallNotification

You can enable an incoming call notification with amplified visuals. The screen and Touch 10 will flash red/white approximately once every second (1.75 Hz) to make it easier for hearing impaired users to notice an incoming call. If the system is already in a call the screen will not flash as this will disturb the on-going call, instead you will get a normal notification on screen and touch panel.

Requires user role: ADMIN, INTEGRATOR, USER

Default value: Default

Value space: AmplifiedVisuals/Default

AmplifiedVisuals: Enable the amplified visuals on screen and touch panel when the video system receives a call.

Default: Enable the default behavior with a notification on screen and touch panel.

### UserInterface ContactInfo Type

Choose which type of contact information to show in the user interface.

Requires user role: ADMIN

Default value: Auto

Value space: Auto/DisplayName/E164Alias/H320Number/H323Id/IPv4/IPv6/None/SipUri/SystemName

Auto: Show the address which another system should dial to reach this video system. The address depends on the default call protocol and system registration.

None: Do not show any contact information.

IPv4: Show the system's IPv4 address.

IPv6: Show the system's IPv6 address.

H323Id: Show the system's H.323 ID (refer to the H323 H323Alias ID setting).

H320Number: Show the system's H.320 number as contact information (only supported if used with Cisco TelePresence ISDN Link).

E164Alias: Show the system's H.323 E164 Alias as contact information (refer to the H323 H323Alias E164 setting).

SipUri: Show the system's SIP URI (refer to the SIP URI setting).

SystemName: Show the system's name (refer to the SystemUnit Name setting).

DisplayName: Show the system's display name (refer to the SIP DisplayName setting).

### UserInterface CustomMessage

A custom message can be displayed, in the lower left side of the screen, in awake mode.

Requires user role: ADMIN, INTEGRATOR

Default value: ""

Value space: String (0, 128)

Add a custom message. Add an empty string to remove a custom message.

## UserInterface KeyTones Mode

You can configure the system to make a keyboard click sound effect (key tone) when typing text or numbers.

Requires user role: ADMIN, USER

Default value: On

Value space: Off/On

Off: There is no key tone sound effect.

On: The key tone sound effect is turned on.

## UserInterface Language

Select the language to be used in the user interface. If the language is not supported, the default language (English) will be used.

Requires user role: ADMIN, USER

Default value: English

Value space: Arabic/Catalan/ChineseSimplified/ChineseTraditional/Czech/Danish/Dutch/English/EnglishUK/Finnish/French/FrenchCanadian/German/Hebrew/Hungarian/Italian/Japanese/Korean/Norwegian/Polish/Portuguese/PortugueseBrazilian/Russian/Spanish/SpanishLatin/Swedish/Turkish

Select a language from the list.

## UserInterface OSD EncryptionIndicator

Define for how long the encryption indicator is shown on screen. The icon for encrypted calls is a locked padlock.

Requires user role: ADMIN

Default value: Auto

Value space: Auto/AlwaysOn/AlwaysOff

Auto: If the call is encrypted, a "Call is encrypted" notification is shown for 5 seconds. Then, an encryption indicator icon is shown for the rest of the call.

If the call is not encrypted, a "Call is not encrypted" notification is shown for 5 seconds. No encryption indicator icon is shown.

AlwaysOn: The "Call is encrypted" notification is shown for 5 seconds. Then, an encryption indicator icon is shown for the rest of the call.

AlwaysOff: The encryption indicator is never displayed on screen.

## UserInterface OSD HalfwakeMessage

A custom message can be displayed in the middle of the main screen when the system is in the half wake state. The custom message will replace the default message, which gives instructions how to start using the video system. You can also delete the default message, without adding a custom message.

Requires user role: ADMIN

Default value: ""

Value space: String (0, 128)

The custom message. An empty string: Restore the default message. A space only: There will be no message at all.

## UserInterface OSD Output

Define on which monitor the on-screen information and indicators (OSD) should be displayed.

Requires user role: ADMIN, INTEGRATOR

Default value: 1

Value space: Auto/1/2/3

Auto: The system detects when a monitor is connected to a video output, and sends the on-screen information and indicators to the first monitor you connect. If you have a multi-monitor setup, and all monitors are connected before switching on the system, the on-screen information and indicators are sent to the video output with the lowest number, starting with Output Connector 1 (HDMI 1).

1-3: The system sends the on-screen information and indicators to the specified output. Choose n to send the on-screen information and indicators to the system's Output Connector n.

## UserInterface Security Mode

This setting allows you to prevent important system information from being exposed in the user interface (drop down menu and Settings panel), for example the contact information and IP addresses of the video system, touch controller, and UCM/VCS registrars. It is important to note that such information is not hidden when navigating further into the Settings panel.

If you want to fully prevent that people without administrator rights can see the contact information, IP addresses, MAC address, serial number, and software version, you must also set the UserInterface SettingsMenu Mode to Locked, and of course have a passphrase for all user accounts with administrator rights.

Requires user role: ADMIN

Default value: Normal

Value space: Normal/Strong

Normal: IP addresses and other system information are shown on the user interface.

Strong: Contact information and IP addresses are not displayed on the user interface (drop down menu and Settings panel).

## UserInterface SettingsMenu Mode

The Settings panel in the user interface (Touch 10 or on-screen) can be protected by the video system's admin password. If this password is blank, anyone can access the settings in the Settings menu, and for example factory reset the system. If authentication is enabled, all settings that require authentication have a padlock icon. You will be prompted to enter the administrator's user name and passphrase when you select the setting. Some settings do not require authentication, they do not have a padlock icon.

Requires user role: ADMIN

Default value: Unlocked

Value space: Locked/Unlocked

Locked: Authentication with administrator's username and passphrase is required.

Unlocked: No authentication is required.

## UserInterface Wallpaper

Select a background image (wallpaper) for the video screen when idle.

You may upload a custom wallpaper to the video system using the web interface. The following file formats are supported: BMP, GIF, JPEG, PNG. The maximum file size is 4 MByte. When you use a custom wallpaper, the clock and the list of upcoming meetings are removed from the main display

Requires user role: ADMIN, INTEGRATOR, USER

Default value: Auto

Value space: Auto/Custom/None

Auto: Use the default wallpaper.

None: There is no background image on the screen.

Custom: Use the custom wallpaper as background image on the screen. If no custom wallpaper is uploaded to the system, the setting will revert to the default value.

## UserManagement settings

### UserManagement LDAP Admin Filter

The LDAP filter is used to determine which users should be granted administrator privileges.

You always have to set either an LDAP Admin Group or an LDAP Admin Filter. An LDAP Admin Filter takes precedence, so if the UserManagement LDAP Admin Filter is set, the UserManagement LDAP Admin Group setting is ignored.

Requires user role: ADMIN

Default value: ""

Value space: String (0, 1024)

Refer to the LDAP specification for the syntax of this string. Example:

```
"(|(memberof=CN=admin group, OU=company groups, DC=company, DC=com)
(sAMAccountName=username))"
```

### UserManagement LDAP Admin Group

Members of this AD (Active Directory) group will be given administrator access. This setting is a shorthand for saying (memberOf:1.2.840.113556.1.4.1941:=<group name>).

You always have to set either an LDAP Admin Group or an LDAP Admin Filter. An LDAP Admin Filter takes precedence, so if the UserManagement LDAP Admin Filter is set, the UserManagement LDAP Admin Group setting is ignored.

Requires user role: ADMIN

Default value: ""

Value space: String (0..255)

The distinguished name of the AD group. Example: "CN=admin group, OU=company groups, DC=company, DC=com"

### UserManagement LDAP Attribute

The attribute used to map to the provided username. If not set, sAMAccountName is used.

Requires user role: ADMIN

Default value: ""

Value space: String (0..255)

The attribute name.

### UserManagement LDAP BaseDN

The distinguishing name of the entry at which to start a search (base).

Requires user role: ADMIN

Default value: ""

Value space: String (0..255)

The distinguishing name of the base. Example: "DC=company, DC=com"

### UserManagement LDAP Encryption

Define how to secure the communication between the video system and the LDAP server. You can override the port number by using the UserManagement LDAP Server Port setting.

Requires user role: ADMIN

Default value: LDAPS

Value space: LDAPS/None/STARTTLS

LDAPS: Connect to the LDAP server on port 636 over TLS (Transport Layer Security).

None: Connect to LDAP server on port 389 with no encryption.

STARTTLS: Connect to LDAP server on port 389, then send STARTTLS to enable TLS encryption.

## UserManagement LDAP MinimumTLSVersion

Set the lowest version of the TLS (Transport Layer Security) protocol that is allowed.

Requires user role: ADMIN

Default value: TLSv1.2

Value space: TLSv1.0/TLSv1.1/TLSv1.2

TLSv1.0: Support TLS version 1.0 or higher.

TLSv1.1: Support TLS version 1.1 or higher.

TLSv1.2: Support TLS version 1.2 or higher.

## UserManagement LDAP Mode

The video system supports the use of an LDAP (Lightweight Directory Access Protocol) server as a central place to store and validate user names and passwords. Use this setting to configure whether or not to use LDAP authentication. Our implementation is tested for the Microsoft Active Directory (AD) service.

If you switch on LDAP Mode, make sure to configure the other UserManagement LDAP settings to suit your setup. Here is a few examples.

Example 1:

- UserManagement LDAP Mode: On
- UserManagement LDAP Address: "192.0.2.20"
- UserManagement LDAP BaseDN: "DC=company, DC=com"
- UserManagement LDAP Admin Group: "CN=admin group, OU=company groups, DC=company, DC=com"

Example 2:

- UserManagement LDAP Mode: On
- UserManagement LDAP Address: "192.0.2.20"
- UserManagement LDAP BaseDN: "DC=company, DC=com"
- UserManagement LDAP Admin Filter: "(!(memberof=CN=admin group, OU=company groups, DC=company, DC=com)(sAMAccountName=username))"

Requires user role: ADMIN

Default value: Off

Value space: Off/On

Off: LDAP authentication is not allowed.

On: LDAP authentication is allowed.

## UserManagement LDAP Server Address

Set the IP address or hostname of the LDAP server.

Requires user role: ADMIN

Default value: ""

Value space: String (0..255)

A valid IPv4 address, IPv6 address or hostname.

## UserManagement LDAP Server Port

Set the port to connect to the LDAP server on. If set to 0, use the default for the selected protocol (see the UserManagement LDAP Encryption setting).

Requires user role: ADMIN

Default value: 0

Value space: Integer (0..65535)

The LDAP server port number.

## UserManagement LDAP VerifyServerCertificate

When the video system connects to an LDAP server, the server will identify itself to the video system by presenting its certificate. Use this setting to determine whether or not the video system will verify the server certificate.

Requires user role: ADMIN

Default value: On

Value space: Off/On

Off: The video system will not verify the LDAP server's certificate.

On: The video system must verify that the LDAP server's certificate is signed by a trusted Certificate Authority (CA). The CA must be on the list of trusted CAs that are uploaded to the system in advance. Use the video system's web interface to manage the list of trusted CAs (see more details in the administrator guide).

## Video settings

### Video ActiveSpeaker DefaultPIPPosition

Define the position on screen of the active speaker picture-in-picture (PiP). The setting only takes effect when using a video layout where the active speaker is a PiP, i.e. the Overlay layout, or possibly a Custom layout (refer to the Video DefaultLayoutFamily Local setting). The setting takes effect from the next call onwards; if changed during a call, it will have no effect on the current call.

Requires user role: ADMIN, INTEGRATOR

Default value: Current

Value space: Current/UpperLeft/UpperCenter/UpperRight/CenterLeft/CenterRight/LowerLeft/LowerRight

Current: The position of the active speaker PiP will be kept unchanged when leaving a call.

UpperLeft: The active speaker PiP will appear in the upper left corner of the screen.

UpperCenter: The active speaker PiP will appear in the upper center position.

UpperRight: The active speaker PiP will appear in the upper right corner of the screen.

CenterLeft: The active speaker PiP will appear in the center left position.

CentreRight: The active speaker PiP will appear in the center right position.

LowerLeft: The active speaker PiP will appear in the lower left corner of the screen.

LowerRight: The active speaker PiP will appear in the lower right corner of the screen.

### Video DefaultLayoutFamily Local

Select which video layout family to use locally.

Requires user role: ADMIN

Default value: Auto

Value space: Auto/Equal/Prominent/Overlay/Single

Auto: The default layout family, as given in the layout database provided by the system, will be used as the local layout.

Equal: The Equal layout family will be used as the local layout. All videos have equal size, as long as there is space enough on the screen.

Prominent: The Prominent layout family will be used as the local layout. The active speaker, or the presentation if present, will be a large picture, while the other participants will be small pictures. Transitions between active speakers are voice switched.

Overlay: The Overlay layout family will be used as the local layout. The active speaker, or the presentation if present, will be shown in full screen, while the other participants will be small pictures-in-picture (PiP). Transitions between active speakers are voice switched.

Single: The active speaker, or the presentation if present, will be shown in full screen. The other participants are not shown. Transitions between active speakers are voice switched.



## Video DefaultLayoutFamily Remote

Select which video layout family to be used for the remote participants.

Requires user role: ADMIN

Default value: Auto

Value space: Auto/Equal/Prominent/Overlay/Single

Auto: The default layout family, as given by the local layout database, will be used as the remote layout.

Equal: The Equal layout family will be used as the remote layout. All videos have equal size, as long as there is space enough on the screen.

Prominent: The Prominent layout family will be used as the remote layout. The active speaker, or the presentation if present, will be a large picture, while the other participants will be small pictures. Transitions between active speakers are voice switched.

Overlay: The Overlay layout family will be used as the remote layout. The active speaker, or the presentation if present, will be shown in full screen, while the other participants will be small pictures-in-picture (PIP). Transitions between active speakers are voice switched.

Single: The active speaker, or the presentation if present, will be shown in full screen. The other participants are not shown. Transitions between active speakers are voice switched.

## Video DefaultMainSource

Define which video input source to be used as the default main video source when you start a call.

Requires user role: ADMIN, USER

Default value: 1

Value space: 1/2/3/4/5/6

Set the source to be used as the default main video source.

## Video Input Connector [1..6] CameraControl Camerald

The camera ID is a unique identifier of the cameras that are connected to the video input. Use the xStatus Camera API command to see the IDs of the different cameras.

Requires user role: ADMIN, INTEGRATOR

Default value: Connector n: n

Value space: Connector n: 1/2/3/4/5/6/7

Select the ID of the camera.

## Video Input Connector [1..6] CameraControl Mode

Define whether the camera that is connected to this video input connector can be controlled or not.

Requires user role: ADMIN, INTEGRATOR

Default value: Connector n: On

Value space: Connector 1,2,3,4,5: Off/On Connector 6: On

Off: Disable camera control.

On: Enable camera control.

## Video Input Connector [1..5] CEC Mode

The video input (HDMI) supports Consumer Electronics Control (CEC). When this setting is enabled, information about the connected device (for example device type and device name) is available in the video system status (Video Input Connector[n] ConnectedDevice CEC [n]), provided that the connected device also supports CEC.

If you have Cisco Quad Camera, do not switch off CEC on that connector because then there will be no sound on the speakers on the camera. CEC is required for HDMI ARC (Audio Return Channel), which is the channel used for sending audio from the codec to the camera.

Requires user role: ADMIN, INTEGRATOR

Default value: On

Value space: Connector n: Off/On

Off: CEC is disabled.

On: CEC is enabled.

## Video Input Connector [1..5] HDCP Mode

Not applicable in this version.

Requires user role: ADMIN, INTEGRATOR

Default value: Off

Value space: Connector n: Off

Off: Disable support for HDCP protected content on the video input connector.

## Video Input Connector [1..6] InputSourceType

Select which type of input source is connected to the video input.

Requires user role: ADMIN, INTEGRATOR

Default value: Connector 1,2,6: camera Connector 3,4,5: PC

Value space: Connector n: PC/camera/document\_camera/mediaplayer/whiteboard/other

PC: Use this when a computer is connected to the video input.

camera: Use this when a camera is connected to the video input.

document\_camera: Use this when a document camera is connected to the video input.

mediaplayer: Use this when a media player is connected to the video input.

whiteboard: Use this when a whiteboard camera is connected to the video input.

other: Use this when the other options do not match.

## Video Input Connector [1..6] Name

Define a name for the video input connector.

Requires user role: ADMIN, INTEGRATOR

Default value: Connector 1: "Camera 1" Connector 2: "Camera 2" Connector 3: "PC 1 (HDMI)" Connector 4: "PC 2 (HDMI)" Connector 5: "PC 3 (HDMI)" Connector 6: "Camera 3 (SDI)"

Value space: String (0, 50)

Name for the video input connector.

## Video Input Connector [1..6] OptimalDefinition Profile

This setting will not take effect if the corresponding Video Input Connector [n] Quality setting is set to Sharpness.

The optimal definition profile reflects the lighting conditions in the video conferencing room and the quality of the camera. The better lighting conditions and the better quality of the camera, the higher the profile. Generally, the Normal or Medium profiles are recommended. However, when the lighting conditions are very good, the High profile can be set in order to increase the resolution for a given call rate. The resolution must be supported by both the calling and called systems.

Requires user role: ADMIN, INTEGRATOR

Default value: Medium

Value space: Normal/Medium/High

Normal: Use this profile for a normally to poorly lit environment. Resolutions will be set rather conservative.

Medium: Requires good and stable lighting conditions and a good quality video input. For some call rates this leads to higher resolution.

High: Requires nearly optimal video conferencing lighting conditions and a good quality video input in order to achieve a good overall experience. Rather high resolutions will be used.

## Video Input Connector [6] OptimalDefinition Threshold60fps

Not applicable.

## Video Input Connector [1..5] PreferredResolution

Define the screen resolution and refresh rate that the video system advertises as its preferred resolution to the source devices that connect to the system via HDMI (for example a laptop). The logic for selection of the resolution on the source side will choose this resolution and refresh rate automatically, unless it is overridden manually by the source device (for example the laptop's display configuration software).

Note that the formats 2560\_1440\_60 and 3840\_2160\_30 use about twice the amount of data compared to the 1920\_1080\_60 format, and requires a presentation cable (or adapter) that is qualified for at least HDMI 1.4b data rates.

Requires user role: ADMIN, INTEGRATOR

Default value: 1920\_1080\_60

Value space: Connector 1,2: 1920\_1080\_60 Connector 3,4,5: 1920\_1080\_60/2560\_1440\_60/3840\_2160\_30

1920\_1080\_60: The resolution is 1920 x 1080, and the refresh rate is 60 Hz.

2560\_1440\_60: The resolution is 2560 x 1440, and the refresh rate is 60 Hz.

3840\_2160\_30: The resolution is 3840 x 2160, and the refresh rate is 30 Hz.

## Video Input Connector [1..6] PresentationSelection

Define how the video system will behave when you connect a presentation source to the video input. In general, any input source can be used as a presentation source; normally, the main camera will not be used as a presentation source.

If the video system is in standby mode, it will wake up when you connect a presentation source. Sharing the presentation with the far end requires additional action (select Share on the user interface) except when this setting is set to AutoShare.

Requires user role: ADMIN, INTEGRATOR

Default value: Connector 1,2,6: Manual Connector 3,4,5: OnConnect

Value space: Connector n: AutoShare/Desktop/Manual/OnConnect

**AutoShare:** While in a call, the content on the video input will automatically be presented to the far end as well as on the local screen when you connect the cable, or when the source is activated otherwise (for example when a connected computer wakes up from sleep mode). You do not have to select Share on the user interface. If a presentation source is already connected when you make or answer a call, you have to manually select Share on the user interface.

**Desktop:** The content on the video input will be presented on the screen when you connect the cable, or when the source is activated otherwise (for example when a connected computer wakes up from sleep mode). This applies both when idle and in a call. Also, the content on the video input will stay on the screen when you leave the call, provided that it was the active input at the time of leaving.

**Manual:** The content on the video input will not be presented on the screen until you select Share from the user interface.

**OnConnect:** The content on the video input will be presented on screen when you connect the cable, or when the source is activated otherwise (for example when a connected computer wakes up from sleep mode). Otherwise, the behavior is the same as in manual mode.

## Video Input Connector [1..6] Quality

When encoding and transmitting video there is a trade-off between high resolution and high frame rate. For some video sources it is more important to transmit high frame rate than high resolution and vice versa. This setting specifies whether to give priority to high frame rate or to high resolution.

If a Quad Camera, SpeakerTrack 60 camera, or Precision 60 camera is detected by the video system this setting is automatically set to Motion. If a user changes this setting manually, it will be set back to Motion after a restart or a camera reconnect.

Requires user role: ADMIN, INTEGRATOR

Default value: Connector 1,2,6: Motion Connector 3,4,5: Sharpness

Value space: Connector n: Motion/Sharpness

Motion: Gives the highest possible frame rate. Used when there is a need for higher frame rates, typically when a large number of participants are present or when there is a lot of motion in the picture.

Sharpness: Gives the highest possible resolution. Used when you want the highest quality of detailed images and graphics.

## Video Input Connector [1..5] RGBQuantizationRange

The devices connected to the video input should follow the rules for RGB video quantization range defined in CEA-861. Unfortunately some devices do not follow the standard and this configuration may be used to override the settings to get a perfect image with any source.

Requires user role: ADMIN, INTEGRATOR

Default value: Auto

Value space: Auto/Full/Limited

Auto: RGB quantization range is automatically selected based on video format according to CEA-861-E. CE video formats will use limited quantization range levels. IT video formats will use full quantization range levels.

Full: Full quantization range. The R, G, B quantization range includes all code values (0 - 255). This is defined in CEA-861-E.

Limited: Limited Quantization Range. R, G, B quantization range that excludes some code values at the extremes (16 - 235). This is defined in CEA-861-E.

## Video Input Connector [1..6] Visibility

Define the visibility of the video input connector in the menus on the user interface.

Requires user role: ADMIN, INTEGRATOR

Default value: Connector 1: Never Other connectors: IfSignal

Value space: Connector n: Always/IfSignal/Never

Always: The menu selection for the video input connector will always be visible on the user interface.

IfSignal: The menu selection for the video input connector will only be visible when something is connected to the video input.

Never: The input source is not expected to be used as a presentation source, and will not show up on the user interface.

## Video Monitors

A monitor role is assigned to each screen using the Video Output Connector [n] MonitorRole setting. The monitor role decides which layout (call participants and presentation) will appear on the screen that is connected to this output. Screens with the same monitor role will get the same layout; screens with different monitor roles will have different layouts.

The monitor layout mode that is set in the Video Monitors setting should reflect the number of different layouts you want in your room setup. Note that some screens can be reserved for presentations.

Requires user role: ADMIN, INTEGRATOR

Default value: Auto

Value space: Auto/Single/Dual/DualPresentationOnly/TriplePresentationOnly/Triple

Auto: The number of screens connected to the video system is automatically detected, and the layout is distributed on the screens according to the monitor role.

Single: The same layout is shown on all screens.

Dual: The layout is distributed on screens with monitor role First and Second. If a presentation is part of the layout, all participants in the call are shown on screens with monitor role First, and the presentation is shown on screens with monitor role Second.

DualPresentationOnly: All participants in the call are shown on screens with monitor role First. If a presentation is part of the layout, the presentation is shown on screens with monitor role Second.

Triple: The layout is distributed on screens with monitor role First, Second and Third. Screens with monitor role Second are used first, then First, and finally Third. If a presentation is part of the layout, all participants in the call are shown on screens with monitor role First and Second, and the presentation is shown on the screen with monitor role Third.

TriplePresentationOnly: All participants in the call are distributed on screens with monitor role First and Second. Screens with monitor role Second are used first, then First. If a presentation is part of the layout, the presentation is shown on the screen with monitor role Third.

## Video Output Connector [1..3] CEC Mode

This video output (HDMI) supports Consumer Electronics Control (CEC).

When this setting is On, the system will use CEC to set the screen in standby when the system itself enters standby. Likewise the system will wake up the screen when the system itself wakes up from standby.

The active video input on a screen is sometimes changed by a user. When a call is started the video system detects if the active video input has been switched to another input on the screen. The video system then switches the input back so the video system is the active video input source. If the video system is not the active input source when the video system goes into standby the screen will not be set to standby.

It's a prerequisite that the screen that is connected to the output is CEC compatible and that CEC is enabled on the screen.

Note that the different manufacturers uses different marketing names for CEC, for example Anynet+ (Samsung); Aquos Link (Sharp); BRAVIA Sync (Sony); HDMI-CEC (Hitachi); Kuro Link (Pioneer); CE-Link and Regza Link (Toshiba); RIHD (Onkyo); HDAVI Control, EZ-Sync, VIERA Link (Panasonic); EasyLink (Philips); and NetCommand for HDMI (Mitsubishi).

Requires user role: ADMIN, INTEGRATOR

Default value: On

Value space: Off/On

Off: CEC is disabled.

On: CEC is enabled.

## Video Output Connector [1..3] Location HorizontalOffset

HorizontalOffset and VerticalOffset settings are associated with each video output. These settings are used to signal the relative position of the displays that are connected to these outputs.

HorizontalOffset = 0 and VerticalOffset = 0 indicates that the display is positioned in center, both horizontally and vertically. A negative horizontal offset indicates that the monitor is left of center, and a positive horizontal offset indicates that the monitor is right of center. A negative vertical offset indicates that the monitor is below center, and a positive vertical offset indicates that the monitor is above center. The magnitude of the offset indicates how far the display is from center (relative to other displays).

Example: You have two screens side by side. The left screen is on Connector 1 and the right screen on Connector 2. Then the following settings will apply:

Video Output Connector 1 Location: HorizontalOffset = 0, VerticalOffset = 0

Video Output Connector 2 Location: HorizontalOffset = 1, VerticalOffset = 0

Example: You have two screens, one below the other. The upper screen is on Connector 1 and the lower screen on Connector 2. Then the following settings will apply:

Video Output Connector 1 Location: HorizontalOffset = 0, VerticalOffset = 0

Video Output Connector 2 Location: HorizontalOffset = 0, VerticalOffset = -1

Requires user role: ADMIN, INTEGRATOR

Default value: Connector 1: -1 Connector 2: 0 Connector 3: 1

Value space: Integer (-100..100)

Range: The value must be between -100 and 100.

## Video Output Connector [1..3] Location VerticalOffset

HorizontalOffset and VerticalOffset settings are associated with each video output. These settings are used to signal the relative position of the displays that are connected to these outputs.

HorizontalOffset = 0 and VerticalOffset = 0 indicates that the display is positioned in center, both horizontally and vertically. A negative horizontal offset indicates that the monitor is left of center, and a positive horizontal offset indicates that the monitor is right of center. A negative vertical offset indicates that the monitor is below center, and a positive vertical offset indicates that the monitor is above center. The magnitude of the offset indicates how far the display is from center (relative to other displays).

Example: You have two screens side by side. The left screen is on Connector 1 and the right screen on Connector 2. Then the following settings will apply:

Video Output Connector 1 Location: HorizontalOffset = 0, VerticalOffset = 0

Video Output Connector 2 Location: HorizontalOffset = 1, VerticalOffset = 0

Example: You have two screens, one below the other. The upper screen is on Connector 1 and the lower screen on Connector 2. Then the following settings will apply:

Video Output Connector 1 Location: HorizontalOffset = 0, VerticalOffset = 0

Video Output Connector 2 Location: HorizontalOffset = 0, VerticalOffset = -1

Requires user role: ADMIN, INTEGRATOR

Default value: Connector n: 0

Value space: Integer (-100..100)

Range: The value must be between -100 and 100.

## Video Output Connector [1..3] MonitorRole

The monitor role describes which video streams will be shown on the screen connected to this video output. Together the Video Monitors setting and the MonitorRole settings for all outputs define which layout (video streams) will be shown on each screen.

Requires user role: ADMIN, INTEGRATOR

Default value: Connector n: Auto

Value space: Auto/First/Second/Third/PresentationOnly/Recorder

**Auto:** The system will detect when a screen is connected, and a monitor role (First, Second, Third) that corresponds with the Video Monitors setting will be assigned automatically.

**First/Second/Third:** Define the role of the screen in a multi-screen setup. In a single-screen setup, there is no difference between First, Second and Third.

**PresentationOnly:** Show presentation video stream if active, and nothing else. Screens/outputs with this monitor role are disregarded by the Video Monitors setting.

**Recorder:** Show all participants, including the local main video (self-view). If active, also show the presentation. Screens/outputs with this monitor role are ignored by the Video Monitors setting.

## Video Output Connector [1..3] Resolution

Define the resolution and refresh rate for the connected screen.

The formats larger than 1920\_1200\_60 requires use of high quality display cables. For guaranteed operation, use display cables that are pre-qualified from Cisco for use at 3840\_2160\_60, or use a cable that has passed the "Premium HDMI certification" program.

Some UHD TVs/displays only enable 3840\_2160\_30 (30 Hz) and not 3840\_2160\_60 (60 Hz) as their default configuration. In such cases the corresponding setting on the TV/display must be reconfigured to allow 3840\_2160\_60 for the HDMI input where the video system is connected.

Requires user role: ADMIN, INTEGRATOR, USER

Default value: Connector n: Auto

Value space: Connector 1,2: Auto/1920\_1080\_50/1920\_1080\_60/1920\_1200\_50/1920\_1200\_60/2560\_1440\_60/3840\_2160\_30/3840\_2160\_60 Connector 3: Auto/1920\_1080\_50/1920\_1080\_60/1920\_1200\_50/1920\_1200\_60/2560\_1440\_60/3840\_2160\_30

**Auto:** The system will automatically try to set the optimal resolution based on negotiation with the connected monitor.

**1920\_1080\_50:** The resolution is 1920 x 1080, and the refresh rate is 50 Hz.

**1920\_1080\_60:** The resolution is 1920 x 1080, and the refresh rate is 60 Hz.

**1920\_1200\_50:** The resolution is 1920 x 1200, and the refresh rate is 50 Hz.

**1920\_1200\_60:** The resolution is 1920 x 1200, and the refresh rate is 60 Hz.

**2560\_1440\_60:** The resolution is 2560 x 1440, and the refresh rate is 60 Hz.

**3840\_2160\_30:** The resolution is 3840 x 2160, and the refresh rate is 30 Hz.

**3840\_2160\_60:** The resolution is 3840 x 2160, and the refresh rate is 60 Hz.

## Video Output Connector [1..3] RGBQuantizationRange

Devices connected to an HDMI output should follow the rules for RGB video quantization range defined in CEA-861. Unfortunately some devices do not follow the standard and this configuration may be used to override the settings to get a perfect image with any display. Most HDMI displays expects full quantization range.

Requires user role: ADMIN, INTEGRATOR

Default value: Full

Value space: Auto/Full/Limited

Auto: RGB quantization range is automatically selected based on the RGB Quantization Range bits (Q0, Q1) in the AVI infoframe. If no AVI infoframe is available, RGB quantization range is selected based on video format according to CEA-861-E.

Full: Full quantization range. The R, G, B quantization range includes all code values (0 - 255). This is defined in CEA-861-E.

Limited: Limited Quantization Range. R, G, B quantization range that excludes some code values at the extremes (16 - 235). This is defined in CEA-861-E.

## Video Presentation DefaultPIPPosition

Define the position on screen of the presentation picture-in-picture (PiP). The setting only takes effect when the presentation is explicitly minimized to a PiP, for example using the user interface. The setting takes effect from the next call onwards; if changed during a call, it will have no effect on the current call.

Requires user role: ADMIN, INTEGRATOR

Default value: Current

Value space: Current/UpperLeft/UpperCenter/UpperRight/CenterLeft/CenterRight/LowerLeft/LowerRight

Current: The position of the presentation PiP will be kept unchanged when leaving a call.

UpperLeft: The presentation PiP will appear in the upper left corner of the screen.

UpperCenter: The presentation PiP will appear in the upper center position.

UpperRight: The presentation PiP will appear in the upper right corner of the screen.

CenterLeft: The presentation PiP will appear in the center left position.

CenterRight: The presentation PiP will appear in the center right position.

LowerLeft: The presentation PiP will appear in the lower left corner of the screen.

LowerRight: The presentation PiP will appear in the lower right corner of the screen.

## Video Presentation DefaultSource

Define which video input source to use as a default presentation source. This setting may be used by the API and 3rd party user interfaces. It is not relevant when using the user interfaces provided by Cisco.

Requires user role: ADMIN, USER

Default value: 3

Value space: 1/2/3/4/5

The video input source to use as default presentation source.

## Video Selfview Default FullscreenMode

Define if the main video source (self-view) shall be shown in full screen or as a small picture-in-picture (PiP) after a call. The setting only takes effect when self-view is switched on (see the Video Selfview Default Mode setting).

Requires user role: ADMIN, INTEGRATOR

Default value: Current

Value space: Off/Current/On

Off: Self-view will be shown as a PiP.

Current: The size of the self-view picture will be kept unchanged when leaving a call, i.e. if it was a PiP during the call, it remains a PiP after the call; if it was fullscreen during the call, it remains fullscreen after the call.

On: The self-view picture will be shown in fullscreen.



## Video Selfview Default Mode

Define if the main video source (self-view) shall be displayed on screen after a call. The position and size of the self-view window is determined by the Video Selfview Default PIPPosition and the Video Selfview Default FullscreenMode settings respectively.

Requires user role: ADMIN, INTEGRATOR

Default value: Current

Value space: Off/Current/On

Off: Self-view is switched off when leaving a call.

Current: Self-view is left as is, i.e. if it was on during the call, it remains on after the call; if it was off during the call, it remains off after the call.

On: Self-view is switched on when leaving a call.

## Video Selfview Default OnMonitorRole

Define which screen/output to display the main video source (self-view) after a call. The value reflects the monitor roles set for the different outputs in the Video Output Connector [n] MonitorRole setting.

The setting applies both when self-view is displayed in full screen, and when it is displayed as picture-in-picture (PiP).

Requires user role: ADMIN, INTEGRATOR

Default value: Current

Value space: Current/First/Second/Third

Current: When leaving a call, the self-view picture will be retained on the same output as it was during the call.

First: The self-view picture will be shown on outputs with the Video Output Connector [n] MonitorRole set to First.

Second: The self-view picture will be shown on outputs with the Video Output Connector [n] MonitorRole set to Second.

Third: The self-view picture will be shown on outputs with the Video Output Connector [n] MonitorRole set to Third.

## Video Selfview Default PIPPosition

Define the position on screen of the small self-view picture-in-picture (PiP) after a call. The setting only takes effect when self-view is switched on (see the Video Selfview Default Mode setting) and fullscreen view is switched off (see the Video Selfview Default FullscreenMode setting).

Requires user role: ADMIN, INTEGRATOR

Default value: Current

Value space: Current/UpperLeft/UpperCenter/UpperRight/CenterLeft/CenterRight/LowerLeft/LowerRight

Current: The position of the self-view PiP will be kept unchanged when leaving a call.

UpperLeft: The self-view PiP will appear in the upper left corner of the screen.

UpperCenter: The self-view PiP will appear in the upper center position.

UpperRight: The self-view PiP will appear in the upper right corner of the screen.

CenterLeft: The self-view PiP will appear in the center left position.

CentreRight: The self-view PiP will appear in the center right position.

LowerLeft: The self-view PiP will appear in the lower left corner of the screen.

LowerRight: The self-view PiP will appear in the lower right corner of the screen.

## Video Selfview OnCall Mode

This setting is used to switch on self-view for a short while when setting up a call. The Video Selfview OnCall Duration setting determines for how long it remains on. This applies when self-view in general is switched off.

Requires user role: ADMIN, INTEGRATOR

Default value: On

Value space: Off/On

Off: Self-view is not shown automatically during call setup.

On: Self-view is shown automatically during call setup.

## Video Selfview OnCall Duration

This setting only has an effect when the Video Selfview OnCall Mode setting is switched On. In this case, the number of seconds set here determines for how long self-view is shown before it is automatically switched off.

Requires user role: ADMIN, INTEGRATOR

Default value: 10

Value space: Integer (1..60)

Range: Choose for how long self-view remains on. The valid range is between 1 and 60 seconds.

## Experimental settings

The Experimental settings are for testing only and should not be used unless agreed with Cisco. These settings are not documented and WILL change in later releases.



# Appendices

## How to use Touch 10

The Touch 10 user interface and its use are described in full detail in the User guide for the video system.

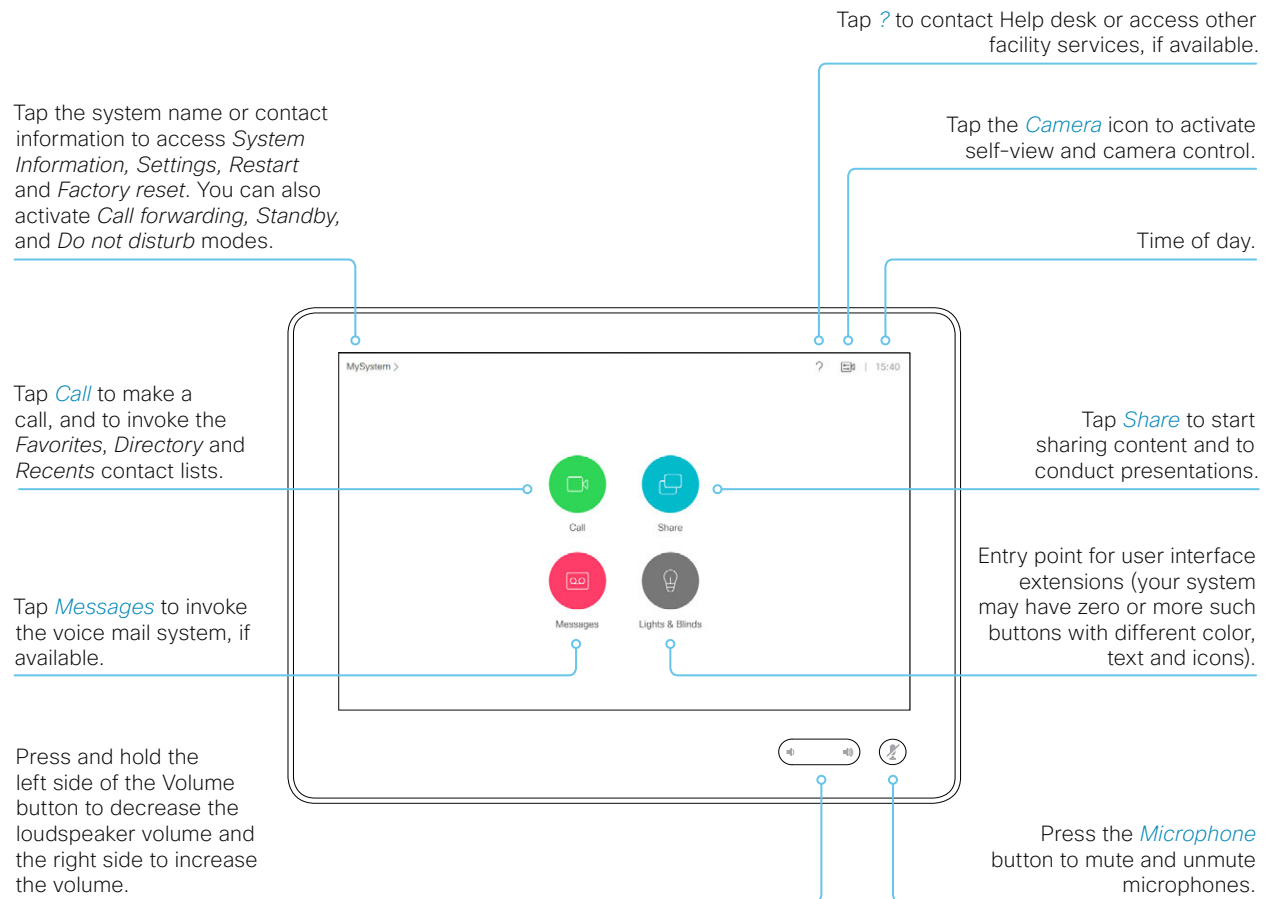

## Set up remote monitoring

Requirement:

- *RemoteMonitoring* option

Remote monitoring is useful when you want to control the video system from another location.

Snapshots from input sources appear in the web interface, so you can check the camera view and control the camera without being in the room.

If enabled, snapshots are refreshed automatically approximately every 5 seconds.

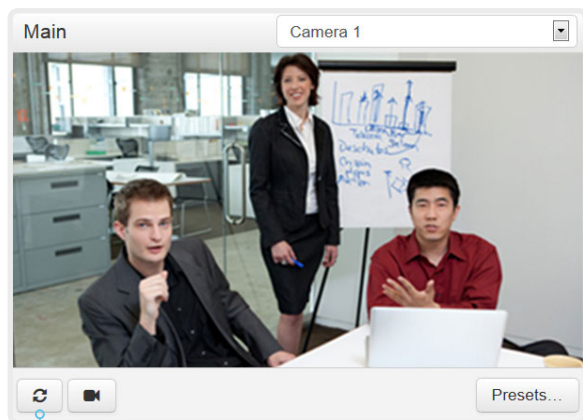

Automatically refresh snapshots

Check whether or not the video system has the *RemoteMonitoring* option

1. Sign in to the web interface.
2. Check the Home page to see if *RemoteMonitoring* is on the list of Installed options.

If not on the list, remote monitoring is not available.

### Enable remote monitoring

Install the *RemoteMonitoring* option key. How to install option keys are described in the [Add option keys](#) chapter.

PLEASE BE AWARE THAT IF YOU ENABLE THE REMOTE MONITORING OPTION YOU MUST MAKE SURE THAT YOU COMPLY WITH LOCAL LAWS AND REGULATIONS WITH REGARD TO PRIVACY AND PROVIDE ADEQUATE NOTICE TO USERS OF THE SYSTEM THAT THE SYSTEM ADMINISTRATOR MAY MONITOR AND CONTROL THE CAMERA AND SCREEN. IT IS YOUR RESPONSIBILITY TO COMPLY WITH PRIVACY REGULATIONS WHEN USING THE SYSTEM AND CISCO DISCLAIMS ALL LIABILITY FOR ANY UNLAWFUL USE OF THIS FEATURE.

## About snapshots

### Local input sources

Snapshots of the local input sources of the video system appear on the Call Control page.

Snapshots appear both when the video system is idle, and when in a call.

### Far end snapshots

When in call, you may also see snapshots from the far end camera. It does not matter whether or not the far end video system has the *RemoteMonitoring* option.

Far end snapshots are not displayed if the call is encrypted.

## Access call information and answer a call while using the web interface

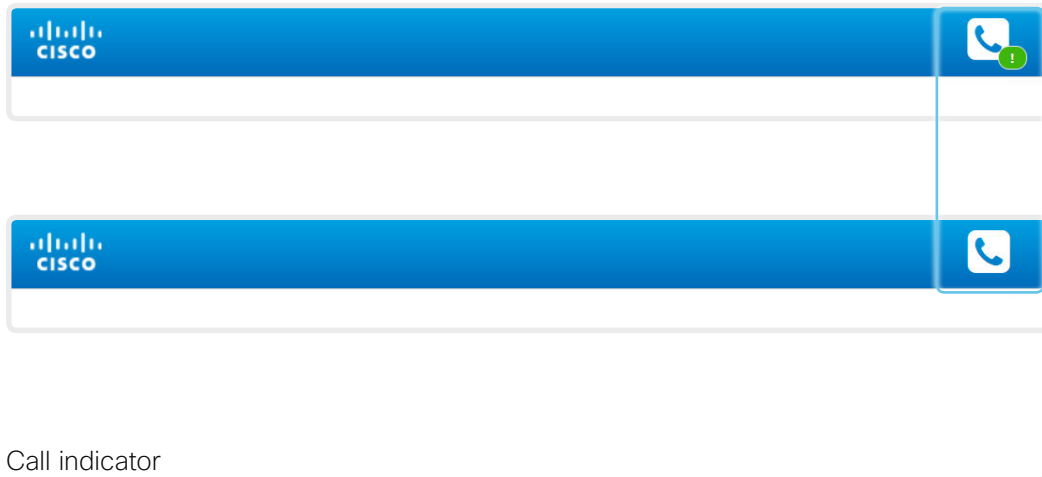

Notification of an incoming call

Click the *Call indicator* to open the *Call Control* page, where you can accept or decline the call.

The system is in a call

Hover the mouse over the call indicator to see the number of active calls.





### Call indicator

The call indicator is present to notify you about an incoming call, and to show when the system is in a call.

If the system is idle, there is no call indicator.

### Control the call

Relevant control buttons are present on the *Call Control* page. Use the buttons to:

-  Show call details
-  Put the call on hold
-  Answer the call
-  Disconnect the call

## Place a call using the web interface (page 1 of 2)

Sign in to the web interface and navigate to [Call Control](#).

### Place a call

**i** Even if the web interface is used to initiate the call, it is the video system (display, microphones and loudspeakers) that is used for the call; it is not the PC running the web interface.

1. Navigate the *Favorites*, *Directory* or *Recents* lists to find the correct entry; or enter one or more characters in the *Search or Dial* field\*. Click the correct contact name.
2. Click [Call](#) in the contact card.

Alternatively, enter the complete URI or number in the *Search and Dial* field. Then click the [Call](#) button that appears next to the URI or number.

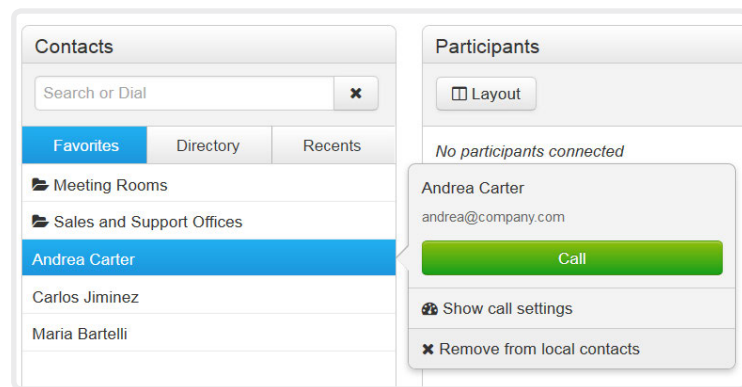

\* When searching, matching entries from the *Favorites*, *Directory* and *Recents* lists will be listed as you type.

### Send DTMF tones

Click to open a key pad that you can use if your application requires DTMF (dual-tone multi-frequency) signaling.



### Show/hide call details

Click the information button to show details about the call.

Click the button again to hide the information.

### Hold and resume a call

Use the **||** button next to a participant's name to put that participant on hold.

To resume the call, use the **▶** button that is present when a participant is on hold.

### End a call

If you want to terminate a call or conference, click [Disconnect all](#). Confirm your choice in the dialog that appears.

To disconnect just one participant in a conference, click the **⏏** button for that participant.



## Place a call using the web interface (page 2 of 2)

Sign in to the web interface and navigate to [Call Control](#).

### Calling more than one

A point-to-point video call (a call involving two parties only) can be expanded to include one more participant on audio-only.

If your system is using the optional built-in MultiSite feature, up to four participants, yourself included, can join the video call (conference). Follow the same procedure to call the next conference participant as you did when calling the first participant.

Calling more than one using a conference bridge (CUCM ad hoc conferencing) is not supported from the web interface, even if it is supported by the video system itself.

### Adjust the volume

#### Mute the microphone

Click [Microphone: On](#) to mute the microphone. Then the text changes to [Microphone: Off](#).

Click [Microphone: Off](#) to unmute.

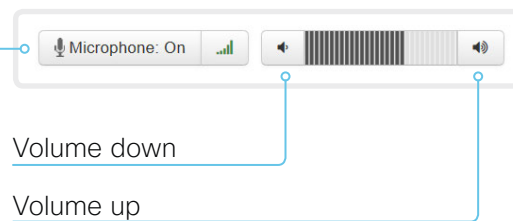

## Share content using the web interface

Sign in to the web interface and navigate to [Call Control](#).

### Share content

1. Choose which content source to share in the *Presentation* source drop down list.
2. Click [Start Presentation](#). Then the text changes to [Stop Presentation](#).

#### Stop content sharing:

Click the [Stop Presentation](#) button that is present while sharing.

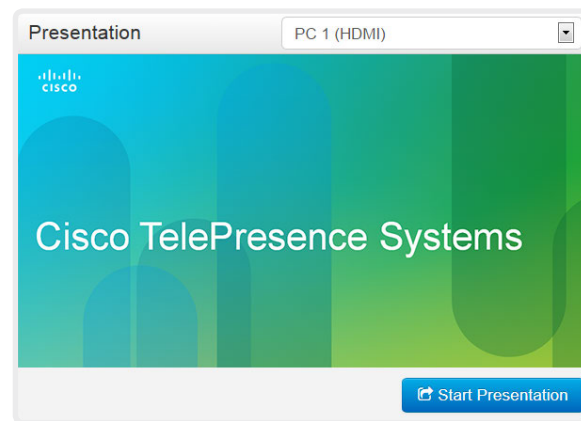

#### Presentation source drop down list

Choose which input source to share, from the drop down list.

#### Snapshot area

Shows snapshots of the selected presentation source.

Only available on video systems that have the *Remote Monitoring* option.

### About content sharing

You can connect a presentation source to one of the video inputs of your video system. Most often a PC is used as presentation source, but other options may be available depending on your system setup.

While in a call you can share content with the other participant in the call (far end).

If you are not in a call, the content is shown locally.

## Local layout control

Sign in to the web interface and navigate to [Call Control](#).

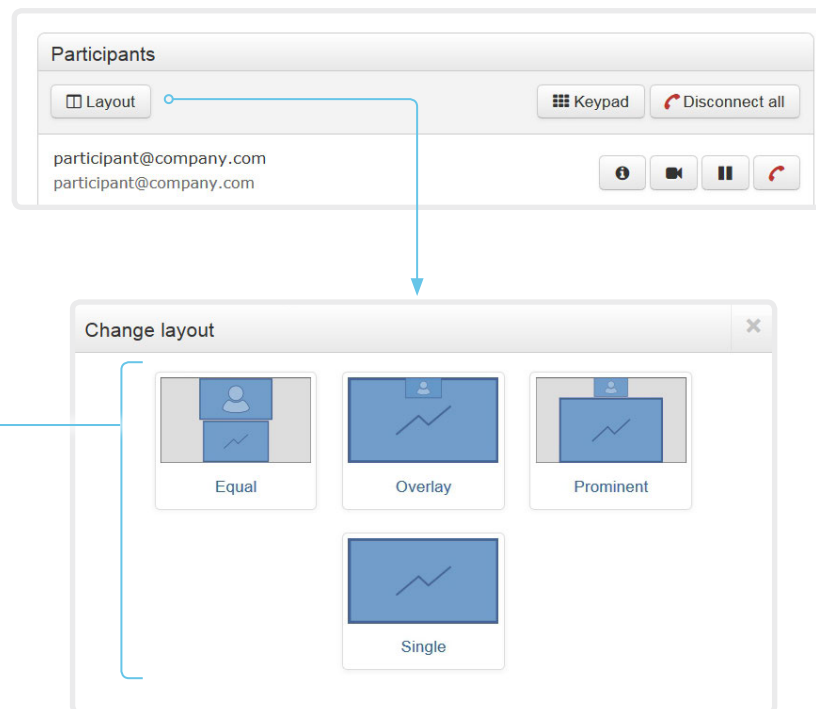

### Change the layout

Click [Layout](#), and choose your preferred layout in the window that opens.

The set of layouts to choose from depends on the system configuration.

You may change the layout both when idle and in a call.

### About layouts

The term layout is used to describe the various ways presentations and videos can appear on the screen. Different types of meetings may require different layouts.

The number of call or conference participants are reflected in the available choices.

## Control a local camera

Sign in to the web interface and navigate to [Call Control](#).

### Prerequisites

- The [Video > Input > Connector n > CameraControl > Mode](#) setting is switched **On**.
- The camera has pan, tilt or zoom functionality.
- Speaker tracking is switched Off.

### Snapshot area

Shows snapshots of the selected main input source.

Only available on video systems that have the *Remote Monitoring* option.

### Automatically refresh snapshots

### Move the camera using the pan/tilt/zoom controls

Camera control is not available when speaker tracking is switched on.

1. Choose which camera to control in the *Main* source drop down list.
2. Click the camera icon to open the camera control window.  
Video snapshots from the room are only displayed for video systems that have the *Remote Monitoring* option.
3. Use the left and right arrows to pan the camera; the up and down arrows to tilt it; and + and - to zoom in and out.  
Only relevant controls appear in the window.
4. Click [Close](#) to close the window.

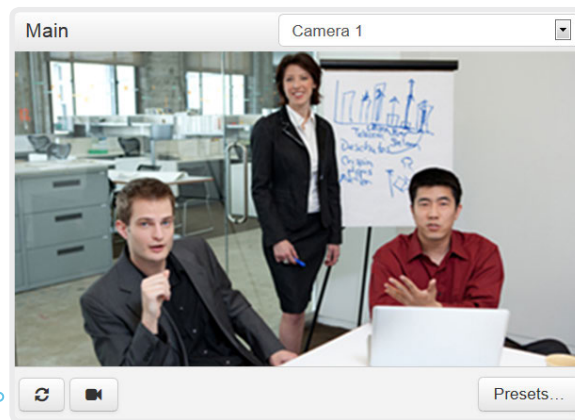

### Main source drop down list

Choose which camera to control from the drop down list.

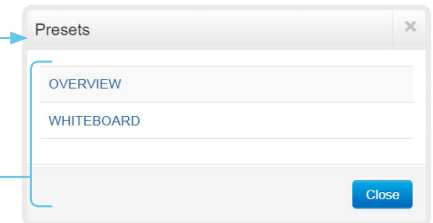

### Move the camera to a preset position

1. Choose which camera to control in the *Main* source drop down list.
2. Click [Presets...](#) to open a list of available presets.  
If no presets are defined, the button is disabled and named *No presets*.
3. Click a preset's name to move the camera to the preset position.
4. Click [Close](#) to close the window.

**i** You cannot use the web interface to define a preset; you should use the Touch controller. When you select a preset, speaker tracking will be switched off automatically.

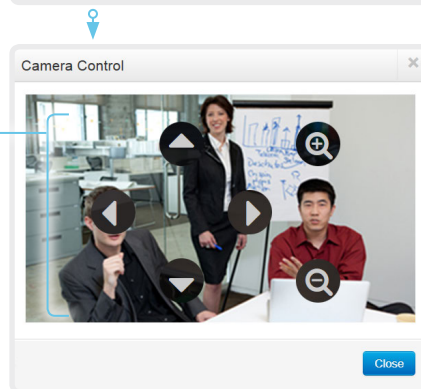

## Control a far end camera

Sign in to the web interface and navigate to [Call Control](#).

### Prerequisites

While in a call, you can control the remote participant's camera (far end) provided that:

- The [Conference > FarEndControl > Mode](#) setting is switched **On** on the far end video system.
- The far end camera has pan, tilt or zoom functionality. Only the relevant controls will appear.
- Speaker tracking is not switched On on the far end camera.
- The local video system has the *Remote Monitoring* option.

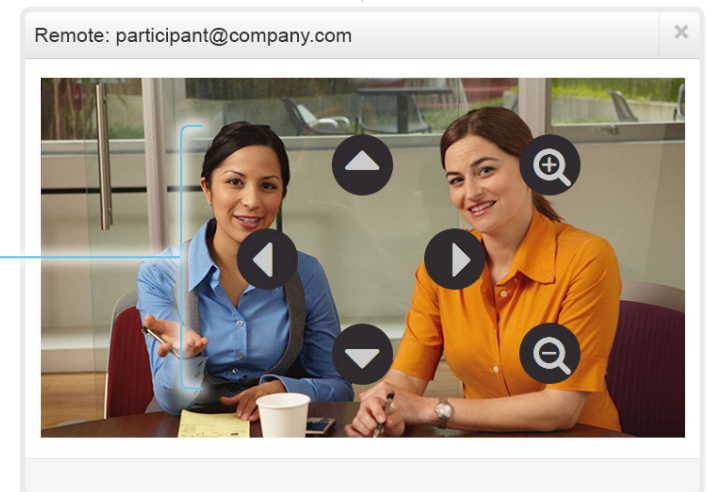
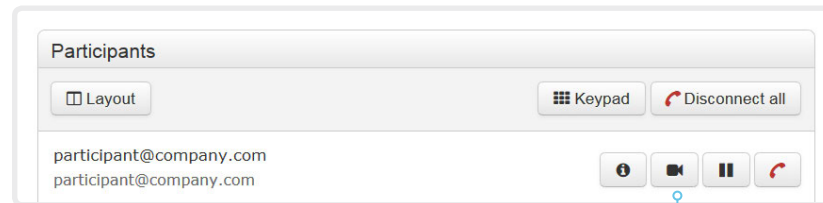

### Control the remote participant's camera

1. Click the camera icon to open the remote camera control window.
2. Use the left and right arrows to pan the camera; the up and down arrows to tilt it; and + and - to zoom in and out.

If you are not allowed to control the far end camera, the controls will not appear in the image.

If the call is encrypted, the far end snapshot behind the controls are not displayed.

## Packet loss resilience – ClearPath

ClearPath introduces several mechanisms for advanced packet loss resilience. These mechanisms increase the experienced quality when you use your video system in an error prone environment.

ClearPath is a Cisco proprietary protocol. All endpoints running CE software support ClearPath.

If the involved endpoints and infrastructure elements support ClearPath, all packet loss resilience mechanisms are used in point-to-point connections (including hosted conferences). Only some of the mechanisms are supported in MultiSite conferences.

## Room analytics

The room analytics feature use several variables from the conference room and re-uses them to analyze the room utilization over time or per call.

### People presence detection

The video system has the capability to find whether or not people are present in the room. It takes a minimum of two minutes to detect whether people are present or not in the room. After the room becomes vacant, it may take up to two minutes for the status to change.

This feature is based on ultrasound. It will not keep record of who was in the room, only whether or not there are people present in the room.

You can turn on/off the people presence detection from the web interface. Sign in to the web interface, and navigate to [Setup > Configuration > RoomAnalytics > PeoplePresenceDetector](#).

### People count

Applies to Codec Pro with Cisco Quad Camera.

By using face detection, the video system can find how many persons are in the room. It will not keep record of who was in the room, only the average number of faces that were detected.

Persons that have not faced the camera will not be counted. If there are objects or pictures in the room that can be detected as faces these might be counted.

The call must have a duration of minimum two minutes in order to get a reliable average. Calls that last less than two minutes, and calls which are made with people count disabled, will display “N/A” when you retrieve call history.

By default, the video system only counts people when in a call, or when it displays the self-view picture.

You can choose to count people outside of call. When enabled, the video system counts people as long as the video system is not in standby mode. This includes outside of call, even if self-view is off. Sign in to the web interface, and navigate to [Setup > Configuration > RoomAnalytics > PeopleCountOutOfCall](#).

### Status

You may see the status at a given moment of people’s presence and people count. Sign in to the web interface, and navigate to [Setup > Status > RoomAnalytics](#).

### Diagnostics

You can see the live people counter on-screen by enabling the SpeakerTrack Diagnostics mode from the Touch 10 controller. Turn on selfview, and tap the contact information in the upper left corner of the Touch controller and open the [Settings](#) menu. Tap [Issues & diagnostics](#) and switch on [SpeakerTrack diagnostics](#).

### Call history command

After a call the average people count value can be extracted from the Call History command.

- `xCommand CallHistory Get DetailLevel: Full`

The Call History command is available from the API (Application Programming Interface). Refer to the API Reference Guide for your product to for details.

Go to: ► <https://www.cisco.com/go/roomkit-docs>

## Customize the video system's Touch 10 user interface (page 1 of 2)

You can customize the user interface to allow control of peripherals in a meeting room, for example lights and blinds, or to modify the video system's behavior by triggering macros.

This allows for the powerful combination of a control system's functionality and the video system's user-friendly user interface (Touch 10).

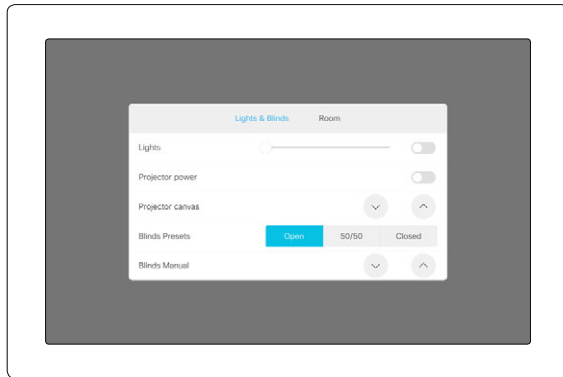

Example in-room control panel

Consult the *CE Customization guide* for full details about how to design custom user interface panels (in-room control panels) using the In-Room Control editor, and how to use the video system's API to program the in-room controls. Go to:

► <https://www.cisco.com/go/in-room-control-docs>

### In-room control architecture

You need a Cisco video system with a Touch 10 controller, and a control system. The control system may be a third-party system, such as Crestron or AMX, with hardware drivers for peripherals. It is the control system, not the video system, that controls the peripherals.

When you program the control system you must use the video system's API (events and commands) in order to connect with the controls on the video system's user interface.

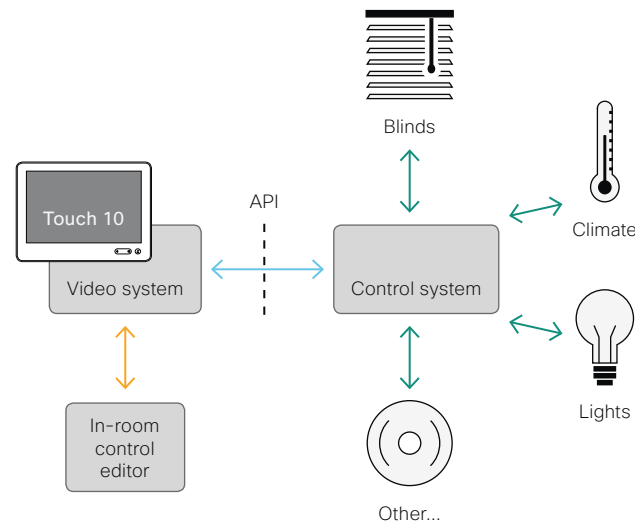

In-room control schematics

The video system's macro framework may also serve as a control system. In this case the control system can use the video system's API to trigger all sorts of local functionality: Speed dial, language selection, customized system reset, and much more.



## Customize the video system's Touch 10 user interface (page 2 of 2)

### The In-Room Control editor

#### Free of charge editor

An easy to use drag-and-drop editor, which you should use to compose the custom user interface panels (in-room control panels), comes free of charge with the video system's software.

Sign in\* to the web interface, and navigate to [Integration > In-Room Control](#).

- Click [Launch Editor](#) to launch the editor directly from the video system's web interface.

You can push a new in-room control panel to the video system, and see the result immediately on the Touch controller.

- Click [Download Editor](#) to download a stand-alone version that you can run locally on your browser from your hard drive.

Then you can compose your custom interfaces without being connected to a video system. You can export and import to file to move your work between your local version and the video system later.

#### Preview function

The editor also provides a preview function, which allows you to see how the custom interfaces will appear on the user interface.

The preview function is also a complete software version of your custom (in-room control) panels, so clicking the controls will result in the same actions as selecting them on the real Touch 10 user interface.

Therefore, you can use the preview function to test your integrations without having a real Touch 10 user interface available. You can also use the video system's in-room controls from a remote location

### The room simulator

You can use the room simulator to visualise how the in-room controls on the Touch 10 user interface changes the state of the room.



Back up any existing in-room configuration you may have before you export the simulator configuration to the video system. The simulator configuration will replace the existing configuration on the video system.

Sign in to the web interface, and navigate to [Integration > In-Room Control](#).

- Click [Launch Simulator](#) to open a room simulator in your browser.

The room simulator contains a predefined in-room control configuration that you can export to the video system. Then you can control the simulator's virtual meeting room from your real Touch 10 user interface.

- Click [Load simulator config](#) to export the simulator configuration to the video system.

---

\* You need a user that holds the ROOMCONTROL, INTEGRATOR, or ADMIN user roles in order to access the In-Room Control editor and the API commands that you need when programming the control system.

## Customize the video system's behavior using macros

With macros, you can create your own snippets of code that run on the video system. The language is JavaScript / ECMAScript 6 with support for features such as arrow functions, promises and classes.

The macro framework allows an integrator to write scripts that tailor a video system's behavior to suite an individual customer's requirements. The integrators can, for example, implement their own features or variations of features, automate specific configurations or re-configurations, and create custom tests and monitoring functions.

By combining the use of macros and creation of a custom user interface panel (formerly referred to as in-room control panel), you can amend the user interface (Touch 10) to trigger customized local functionality. For examples:

- Add speed dialling buttons
- Add a button for room reset, which set all configurations back to your preferred default setup

Consult the *CE Customization guide* for details about macros and how to use the video system's built in Macro editor. Go to:

► <https://www.cisco.com/go/in-room-control-docs>

### Allow using macros on the video system

Sign in to the web interface and navigate to *Setup > Configuration*.

- Set *Macros > Mode* to **On**.

If you try to launch the Macro editor while this setting is **Off**, a pop-up message appears. If you respond by tapping *Enable Macros*, the *Macros > Mode* setting will automatically change to **On**, and the editor will launch.

### Launch the macro editor

Sign in\* to the web interface, and navigate to *Integration > Macro Editor*.

We don't offer a stand-alone version of the editor that you can use to work offline.

### The Macro editor

The Macro editor is a powerful tool where you can:

- Load our code examples, which you can modify, use as is, or use as inspiration when writing your own macros.
- Read our detailed macro scripting tutorial, which also explains the code examples in more detailed.
- Write your own macros, and upload them to the video system.
- Enable/Disable individual macros.
- Check in an embedded Log Console what happens when you run a macro.

---

\* You need a user that holds the ADMIN user role in order to access the Macro editor.

## Input source composition (page 1 of 2)

You can use the video system's API to combine up to four input sources in a single main video stream.

The maximum number of *different* input sources depends on the video system:

Video system	Maximum number of different input sources
Room Kit, SX20, MX200 G2, MX300 G2	2
Codec Plus, Room 55, Room 55 Dual, Room 70	3
SX80, MX700, MX800, Codec Pro, Room 70 G2	4
SX10, DX70, DX80	Not applicable

## Source composition

### Composition layout

You can choose between two layouts:

- Equal
- PIP (only available when composing two input sources)

The layouts are fixed, so you cannot modify the image sizes, or move the PIP.

The composition and layout can be modified at any time, both in call and outside of call.

### Selfview

Selfview shows the same composed image that is being sent to the far end.

### Individual camera control

You can control individual cameras using API commands (`xCommand Camera *`), but you cannot use the controls on the user interface.

When you select a camera in the user interface, the main video stream will automatically switch from the composed video stream to the single stream from the chosen camera.

### Change compositions and layouts on demand

Input source composition is only available using API commands; we don't provide a dedicated user interface for it.

To be able to easily change compositions and layouts on demand, we recommend that you use macros and create a custom user interface panel (in-room control panel) for it.

## Layouts

### Equal

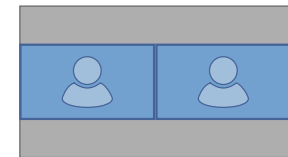

Number of sources: 2

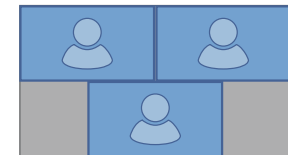

Number of sources: 3

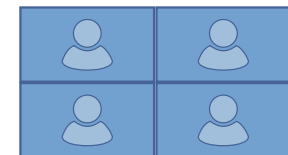

Number of sources: 4

### Picture-in-Picture (PIP)

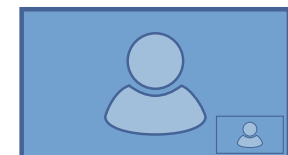

Number of sources: 2

## Input source composition (page 2 of 2)

### API command

```
xCommand Video Input SetMainVideoSource
ConnectorId: <1..n> SourceId: <1..m>
Layout: <Equal, PIP>
```

where

The input source can be identified by either the physical connector that it is connected to (ConnectorId), or by the logical source identifier (SourceId). There cannot be a mix of different types of identifiers in the same command; use either ConnectorId or SourceId. You can find these identifiers in the *Video Input Connector* and *Video Input Source* statuses.

The difference between the Equal and PIP layouts (Layout) are shown in the sidebar.

Refer to the API-guide for more details.

### Examples

```
xCommand Video Input SetMainVideoSource ConnectorId: 1 ConnectorId: 2 ConnectorId: 3 ConnectorId: 4 Layout: Equal
```



```
xCommand Video Input SetMainVideoSource ConnectorId: 1 ConnectorId: 2 Layout: Equal
```

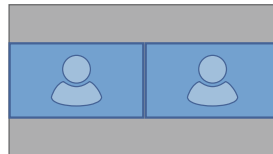

```
xCommand Video Input SetMainVideoSource SourceId: 1 SourceId: 2 Layout: PIP
```

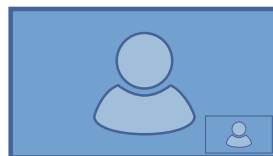

## Presentation source composition (page 1 of 2)

You can use the video system's API to combine up to four presentation sources in a single video stream.

The maximum number of *different* presentation sources depends on the video system:

Video system	Maximum number of different presentation sources
Room Kit, SX20, MX200 G2, MX300 G2	2
Codec Plus, Room 55, Room 55 Dual, Room 70	3
SX80, MX700, MX800, Codec Pro, Room 70 G2	4
SX10, DX70, DX80	Not applicable

You can only share sources that has been shared through a cable (DVI, VGA, HDMI - depending on the video system).

### Source composition

#### Composition layout

The presentation sources will always be composed in Equal layout. You cannot modify the image sizes.

You can change the number of sources at any time, both in call and outside of call.

The order in which the sources appear on the screen depends on the order they have in the command; starting from upper left, ending at bottom right.

#### Change compositions and layouts on demand

Presentation source composition is only available using API commands; we don't provide a dedicated user interface for it.

To be able to easily change compositions and layouts on demand, we recommend that you use macros and create a custom user interface panel (in-room control panel) for it.

### Layouts

#### Equal

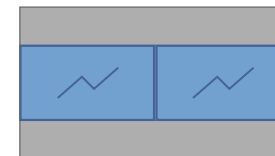

Number of sources: 2



Number of sources: 3



Number of sources: 4

## Presentation source composition (page 2 of 2)

### API command

```
xCommand Presentation Start
  ConnectorId: <1..n>
  PresentationSource: <1..m>
  Instance: <1..p>
  SendingMode: <LocalRemote, LocalOnly>
```

where

The input source can be identified by either the physical connector that it is connected to (ConnectorId), or by the logical source identifier (PresentationSource). There cannot be a mix of different types of identifiers in the same command; use either ConnectorId or PresentationSource. You can find these identifiers in the *Video Input Connector* and *Video Input Source* statuses.

Refer to the API-guide for more details.

### Examples

```
xCommand Presentation Start PresentationSource: 1 PresentationSource: 2 PresentationSource: 3 PresentationSource: 4
```



```
xCommand Presentation Start ConnectorId: 1 ConnectorId: 2 ConnectorId: 3 ConnectorId: 4
```



```
xCommand Presentation Start PresentationSource: 1 PresentationSource: 2
```



```
xCommand Presentation Start ConnectorId: 1 ConnectorId: 2
```



## Manage startup scripts

Sign in to the web interface, and navigate to [Integration > Startup Scripts](#).

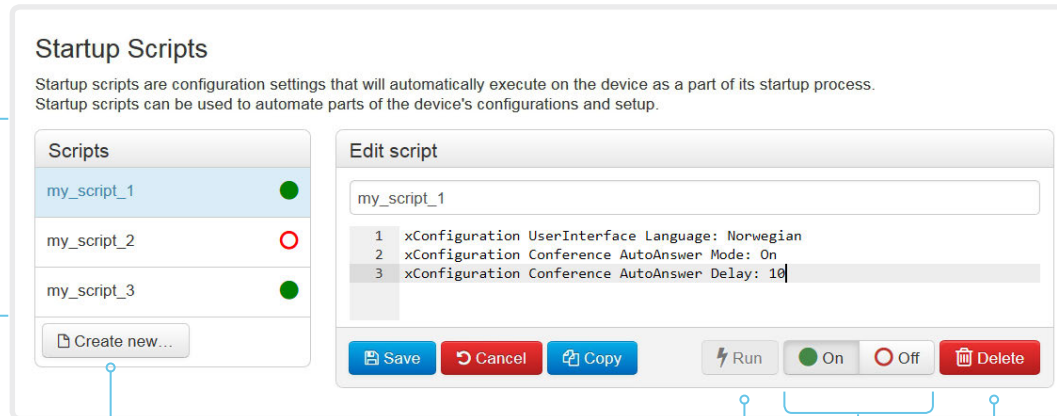

The script names and configurations shown in the illustration serve as examples. You may make your own scripts.

### List of startup scripts

You can create one or more startup scripts\*.

A green dot appears next to an active startup script; a red ring appears next to an inactive startup script.

If you have more than one startup script, they will run in the order from top to bottom of the list.

### Create a startup script

1. Click [Create new...](#)
2. Enter a name for the startup script in the title input field.
3. Enter the commands (xConfiguration or xCommand) in the command input area. Start each command on a new line.
4. Click [Save](#).
5. Click [On](#) to activate the startup script.

If you want to use an existing script as a starting point for editing, select that script and click [Copy](#).

### Run a startup script immediately

1. Select the startup script from the list.
2. Click [Run](#).  
Both active and inactive startup scripts can be run immediately.

### Activate or deactivate a startup script

1. Select the startup script from the list.
2. Click [On](#) to activate, or [Off](#) to deactivate a script.  
Active startup scripts will run every time the video system starts up.

### Delete a startup script

1. Select the startup script from the list.
2. Click [Delete](#).

## About startup scripts

A startup script contains commands (xCommand) and configurations (xConfiguration) that will be executed as part of the start up procedure.

A few commands and configurations cannot be placed in a startup script, for example xCommand SystemUnit Boot. It is not possible to save a script that contains illegal commands and configurations.

Syntax and semantics for xCommand and xConfiguration are explained in the API guide for the product.

## Access the video system's XML files

Sign in to the web interface and navigate to [Integration > Developer API](#).

The XML files are part of the video system's API. They structure information about the system in a hierarchy.

- *Configuration.xml* contains the current system settings (configuration). These settings are controlled from the web interface or from the API (Application Programmer Interface).
- The information in *status.xml* is constantly updated by the video system to reflect system and process changes. The status information is monitored from the web interface or from the API.
- *Command.xml* contains an overview of the commands available to instruct the system to perform an action. The commands are issued from the API.
- *Valuespace.xml* contains an overview of all the value spaces of system settings, status information, and commands.

### Open an XML file

Click the file name to open the XML file.

### About the API

The application programming interface (API) is a tool for integration professionals and developers working with the video system. The API is described in detail in the API guide for the video system.



## Execute API commands and configurations from the web interface

Sign in to the web interface and navigate to [Integration > Developer API](#).

Commands (xCommand) and configurations (xConfiguration) can be executed from the web interface. Syntax and semantics are explained in the API guide for the video system.

### Execute API commands and configurations

1. Enter a command (xCommand or xConfiguration), or a sequence of commands, in the text area.
2. Click [Execute](#) to issue the command(s).

**Execute API commands and configurations**

In the field below you can enter API commands (xCommand and xConfiguration) directly.

For example: xCommand Dial Number: "person@example.com" Protocol: Sip

Enter commands...

Execute

### About the API

The application programming interface (API) is a tool for integration professionals and developers working with the video system. The API is described in detail in the API guide for the video system.

## Advanced customization of audio

Sign in to the web interface and navigate to [Setup > Audio Console](#).

This opens the Audio Console, which provides a graphical interface to advanced customizable audio features. The Audio Console lets you define how audio inputs and outputs should be connected together, using simple drag and drop techniques.

The main features of the Audio Console are:

- Configure the audio system of the codec
- Change the default mixing, routing and equalizers
- Set various input and output connector properties
- Configure advanced features such as local reinforcement

See the *CE Customization guide* for details about the Audio Console. Go to:

▶ <https://www.cisco.com/go/in-room-control-docs>

The Audio Console is replacing the CE Console application that was available for SX80 in previous releases. The CE Console is no longer maintained

## Connector panel

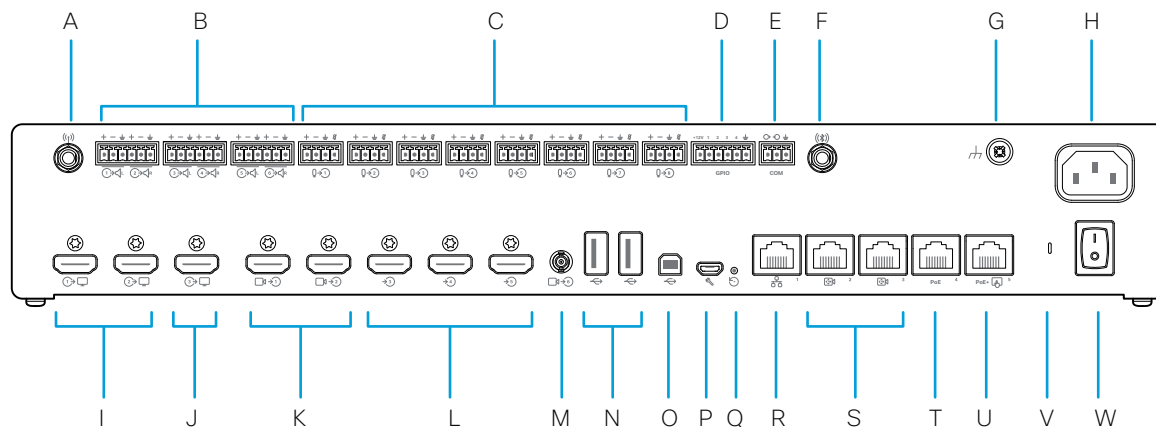

- A. Antenna connector
- B. 6 × Line outputs (Euroblock, 3.5 mm)
- C. 8 × Microphone/Line inputs (Euroblock, 3.5 mm)
- D. Programmable GPIO port (Euroblock, 3.5 mm)
- E. COM port (Euroblock, 3.5 mm)
- F. Antenna connector
- G. Ground (Protective earth)
- H. Main power input (1.3 - 0.6A, 100-240Vac, 50/60Hz)
- I. 2 × HDMI outputs with audio and video (Connector 1-2), 4Kp60
- J. HDMI output with audio and video (Connector 3), 4Kp30
- K. 2 × Camera inputs (HDMI, Connector 1-2), 1080p60
- L. 3 × HDMI inputs with audio and video (Connector 3-5), 4Kp30
- M. Camera input (3G-SDI/HD-SDI, Connector 6), 1080p60, HD-BNC, 75Ω
- N. 2 × USB 2.0, type A
- O. USB 2.0, type B
- P. Maintenance (micro USB)
- Q. Factory reset pin-hole
- R. Network (Ethernet) 1Gb
- S. 2 × Camera control (Ethernet)
- T. Ethernet PoE - Internal network port for PoE device
- U. Touch panel (user interface, Ethernet PoE)
- V. Status LED
- W. Power On/Off

## Serial interface for maintenance

Use the micro USB connector for direct communication with the video system<sup>1</sup>. You need a micro USB to USB cable. If the computer doesn't auto-install a serial port driver, you need to install a serial port driver on the computer manually.<sup>2</sup>

Use a terminal emulator (SSH client) to connect to the serial interface. For the most common computer types (PC, MAC) and operating systems, PuTTY or Tera Term will work.

The serial connection can be used without an IP-address, DNS, or a network.

Parameters:

- Baud rate: 115200bps
- Data bits: 8
- Parity: None
- Stop bit: 1
- Hardware flow control: Off

### Video system settings

Serial communication is enabled by default. Use the following configuration to change the behavior:

*SerialPort > Mode*

For security reasons, you are asked to sign in before using the serial interface. Use the following setting to change the behavior:

*SerialPort > LoginRequired*

Restart the video system when you have made changes to the serial port settings.

If your video system is provisioned by CUCM, the serial port settings should be configured from CUCM.

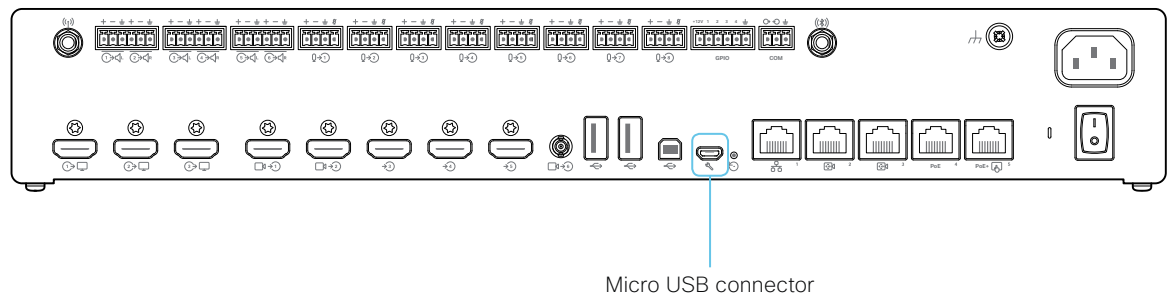

<sup>1</sup> The micro-USB port is for maintenance. If you want to access the video system's API over a serial connection, connect to the USB port (type A). Refer to the API guide for details.

<sup>2</sup> You need a CP210x USB to UART Bridge Virtual COM Port (VCP) driver, see <http://www.silabs.com/products/development-tools/software/usb-to-uart-bridge-vcp-drivers>

## Open TCP Ports

The web server within the codec prohibit or restrict the use of nonsecure or unnecessary ports, protocols, modules, and/or services. Some ports are open or closed by default.

### TCP 22: SSH

You can close the port by setting SSH mode to **Off**.

```
NetworkServices SSH Mode: Off/On
```

### TCP 80: HTTP

You can close the port by setting HTTP mode to **Off** or **HTTPS**.

```
NetworkServices HTTP Mode: HTTP+HTTPS/HTTPS/Off
```

### TCP 443: HTTPS

You can close the port by setting HTTP mode to **Off**.

```
NetworkServices HTTP Mode: HTTP+HTTPS/HTTPS/Off
```

### TCP 4043: Remote pairing software download

You can close the port by setting remote pairing for the Touch panel to **Off**.

```
Peripherals Pairing CiscoTouchPanels RemotePairing: Off/On
```

### TCP 4045: Remote pairing version information

You can close the port by setting remote pairing for the Touch panel to **Off**.

```
Peripherals Pairing CiscoTouchPanels RemotePairing: Off/On
```

### TCP 4051: Remote pairing session connection

The port is only available (and open) when a Touch panel is remote paired with the video system. You can close the port by setting remote pairing for the Touch panel to **Off**.

```
Peripherals Pairing CiscoTouchPanels RemotePairing: Off/On
```

### TCP 4052: Remote pairing and forwarding

The port is only available (and open) when a Touch panel is remote paired with the video system. You can close the port by setting remote pairing for the Touch panel to **Off**.

```
Peripherals Pairing CiscoTouchPanels RemotePairing: Off/On
```

### TCP 4053: Remote pairing port

You can close the port by setting remote pairing for the Touch panel to **Off**.

```
Peripherals Pairing CiscoTouchPanels RemotePairing: Off/On
```

### TCP 5060/5061: SIP listen ports

The SIP listen ports are open by default. The SIP listen ports are disabled by the Cisco UCM (Unified Communication Manager). You can close the ports by setting the SIP listen ports to **Off**.

```
SIP ListenPort: Off/On
```

The system settings are configured from the [Setup > Configuration](#) page on the web interface. Open a web browser and enter the IP address of the video system then sign in.

## Get a new HTTPFeedback address from TMS

When a video system is added to Cisco TelePresence Management Suite (TMS), it is automatically configured to send information (events) back to TMS. The video system receives the address that these events should be sent to from TMS (HTTPFeedback address). If this address is absent or misconfigured, the video system cannot send events to TMS.

### Missing response to events

If the video system does not receive a response to an event, it will retry sending it to the HTTPFeedback address up to 10 times at 1 second intervals.

If the video system does not receive a response to any of the retries, the endpoint deletes the HTTPFeedback address and cannot send events to TMS anymore.

This causes loss of Call Detail Records (CDR) on TMS.

### Get a new HTTPFeedback address from TMS

In order to get a new address to send events to, you must restart the video system and wait for the next management address push from TMS (scheduled or triggered by the TMS administrator).

## Technical specification (page 1 of 2)

### SOFTWARE COMPATIBILITY

- Cisco Collaboration Endpoint Software Version 9.4 or later
- RoomOS

### COMPONENTS

- Cisco Webex Room Kit Pro with Cisco Webex Codec Pro and Cisco Quad Camera
- Cisco Webex Room Kit Pro Precision 60 with Cisco Webex Codec Pro and Cisco TelePresence Precision 60 camera
- Optional components: Cisco Table Microphone (with Euroblock plug), wall mount for Codec Pro, rack mount for Codec Pro, various cables

### BANDWIDTH

- Up to 6Mbps point-to-point

### MINIMUM BANDWIDTH FOR RESOLUTION/FRATE

H.264

- 720p30 from 768kbps
- 720p60 from 1152kbps
- 1080p30 from 1472kbps
- 1080p60 from 2560kbps

### FIREWALL TRAVERSAL

- Cisco Expressway™ technology
- H.460.18, H.460.19 firewall traversal

### VIDEO STANDARDS

- H.264
- H.265 (SIP)
- H.263 for TANDBERG MXP interop only

### VIDEO INPUTS

- Two HDMI inputs support formats up to maximum 1080p60
- Three HDMI inputs support formats up to maximum UHD (3840 x 2160) @ 30 fps including HD1080p60
- One 3G-SDI/HD-SDI input supports formats up to maximum 1080p60
- Extended Display Identification Data (EDID)
- Consumer Electronics Control (CEC) 2.0

### VIDEO OUTPUTS

- Two HDMI outputs support formats up to 3840 x 2160@60 fps (4Kp60)
- One HDMI output supports formats up to 3840 x 2160@30 fps (4Kp30)
- CEC 2.0
- Live video resolutions (encode and decode); Video: Full HD 1080p60; Content: 4K 2160p15
- Consumer Electronics Control (CEC) 2.0

### AUDIO STANDARDS

- G.711,
- G.722
- G.722.1
- G.729AB
- 64 kbps and 128 kbps MPEG4
- AAC-LD mono and stereo,
- OPUS

### AUDIO FEATURES

- High quality 20-kHz audio
- Eight separate acoustic echo cancellers
- Eight-port audio mixer
- Eight assignable equalizers
- Automatic Gain Control (AGC)
- Automatic noise reduction
- Active lip synchronization

### AUDIO INPUTS

- Eight microphones, 48V phantom powered, Euroblock connector, each with separate echo cancellers and noise reduction; all microphones can be set for balanced line level
- Three HDMI, digital: stereo PC/DVD input

### AUDIO OUTPUTS

- Six balanced line level outputs, Euroblock connector
- Three HDMI outputs
- One HDMI input #1 supports Audio Return Channel (ARC) audio output to Quad Camera
- One line out for subwoofer (Quad Camera)

### SPEAKER TRACKING

- Quad Camera:
  - High-quality speakers
  - Frequency response 70 Hz to 20 kHz
  - Max output level SPL 90 dB
- Quad Camera, SpeakerTrack 60:
  - 6-element microphone array for accurate speaker tracking

### DUAL STREAM

- H.239 dual stream (H.323)
- BFCP dual stream (SIP)
- Support for resolutions up to 3840 x 2160 at 15 fps; up to 1920 x 1080 at 60 fps

### WIRELESS SHARING

- Cisco Webex client (up to 3840 x 2160 at 5 fps)
- Cisco Intelligent Proximity client (up to 1920 x 1080 at 5 fps)

### MULTIPOINT SUPPORT

- 5-way embedded SIP/H.323 conferencing capability with MultiSite option

### MULTISITE FEATURES (EMBEDDED MULTIPOINT) (OPTIONAL UPGRADE)

- Adaptive SIP/H.323 MultiSite
  - 3-way resolution up to 1080 at 30 fps plus content up to 4K at 15 fps
  - 4-way resolution up to 720 at 30 fps plus content up to 4K at 15 fps
  - 5-way resolution up to 720 at 30 fps plus content up to 4K at 15 fps
- Full individual audio and video transcoding
- H.323/SIP/VoIP in the same conference
- Support for presentation (H.239/BFCP) from any participant at resolutions up to 3840 x 2160 at 5 fps
- Best Impression (automatic continuous presence layouts)
- Encryption and dual stream from any site

### PROTOCOLS

- H.323
- SIP
- Cisco Webex

### EMBEDDED ENCRYPTION

- H.323 and SIP point-to-point
- Standards-based: H.235 v3 and Advanced Encryption Standard (AES)
- Automatic key generation and exchange

### IP NETWORK FEATURES

- DNS lookup for service configuration
- Differentiated services (Quality of Service [QoS])
- IP-adaptive bandwidth management (including flow control)
- Automatic gatekeeper discovery
- Dynamic playout and lip-sync buffering
- H.245 Dual-Tone Multi-frequency (DTMF) tones in H.323
- RFC 4733 DTMF tones in SIP
- Date and time support using Network Time Protocol (NTP)
- Packet loss-based down speeding
- Uniform resource identifier (URI) dialing
- TCP/IP
- Dynamic Host Configuration Protocol (DHCP)
- 802.1X network authentication
- 802.1Q Virtual LAN
- 802.1p QoS and class of service
- Cisco Media Assure and ClearPath

### IPV6 NETWORK SUPPORT

- Single call stack support for both H.323 and SIP
- Dual-stack IPv4 and IPv6 for DHCP, SSH, HTTP, HTTPS, DNS, DiffServ
- Support for static IP address assignment, stateless autoconfiguration, and DHCPv6

## Technical specification (page 2 of 2)

### CALL CONTROL

- Cisco Collaboration Cloud / Webex
- Cisco Unified Communications Manager (CUCM)
  - Native registration CUCM
  - Requires CUCM Version 10.5.2 or later with device pack Room Kit Pro
- Cisco TelePresence Video Communication Server (VCS)
  - Native registration with VCS
- Third-party H.323 gatekeepers and standards-based SIP proxies
- Cisco TelePresence Management Suite (TMS)
  - Support from version TMS 15.7

### SECURITY FEATURES

- Management using HTTPS and SSH
- IP administration password
- Password to access administration features on Touch controllerDisable IP services
- Network settings protection

### NETWORK INTERFACES

- One Ethernet (RJ-45) 10/100/1000 for LAN
- Two Ethernet (RJ-45) 10/100/1000 for direct pairing with camera (camera control)
- Two Ethernet (RJ-45) 10/100/1000 with PoE, 1 dedicated for direct pairing with Touch 10
- Wi-Fi 802.11a/b/g/n/ac 2.4 GHz and 5 GHz for LAN
- 2x2 multiple input and multiple output (MIMO)
- Bluetooth 4.0 LE

### OTHER INTERFACES

- Two USB 2.0 port type A (for internal use)
- USB 2.0 port type B (for future use)
- Micro USB for maintenance)
- Factory reset pinhole

### CISCO QUAD CAMERA

- 5K Ultra HD camera
- Support up to 60 fps
- 15.1 MP image sensor
- 1/1.7 CMOS
- 5x digital zoom (3 tele-lenses, each with 50° horizontal field of view)
- f/2.0 aperture
- 83° horizontal field of view
- 51.5° vertical field of view
- Auto-framing (audio + face detect)
- 5120 × 2880 pixel resolution
- Auto focus, brightness, and white balance
- Focus distance 1 m to infinity

### CISCO TELEPRESENCE PRECISION 60 CAMERA

- 10 x optical zoom
- 2 x digital zoom
- 20 x total zoom
- Motorized +20°/-20° tilt
- Motorized ± 100° pan
- 48.8° vertical field of view
- 80° horizontal field of view
- F 1.5
- Focus distance 1 m – infinity (wide)
- 1920 × 1080 pixels at 60 fps
- Automatic or manual focus, brightness and white balance
- Ethernet camera control, (RJ-45) 10/100 Mbit
- Far-end camera control
- HDMI 1.4 and 3G-SDI output, and Daisy chain
- Upside-down mounting with automatic flipping of picture

### POWER (QUAD CAMERA)

- 100 to 240 VAC, 50/60 Hz, 12V DC input
- Standby 6W, average 20W, peak 70W

### POWER (CODEC PRO)

- Autosensing power supply
- 100-240V<sub>AC</sub>, 50/60Hz

### OPERATING TEMPERATURE AND HUMIDITY

- 0° to 40°C (32° to 104°F) ambient temperature
- 10% to 90% relative humidity (RH)

### STORAGE AND TRANSPORT TEMPERATURE

- -20°C to 60°C (-4°F to 140°F) at RH 10% to 90% (non-condensing)

### DIMENSIONS

- Quad Camera
  - Width: 37.4 in. (95.0 cm)
  - Height: 4.7 in. (12.0 cm)
  - Depth: 4.0 in. (10.3 cm)
  - Weight: 10.6 lb (4.8 kg)
- Codec Pro
  - Width: 17.1 in. (43.6 cm)
  - Height: 2.6 in. (6.6 cm)
  - Depth: 9.1 in. (23.1 cm)
  - Weight: 7.3 lb ( 3.3 kg)

### APPROVALS AND COMPLIANCE

- Regulatory Compliance:
  - Directive 2014/30/EU (EMC Directive) and Directive 2014/35/EU (Low-Voltage Directive) for the non-radio versions
  - Directive 2014/53/EU (Radio Equipment Directive) for the radio versions
  - Directive 2011/65/EU (RoHS)
  - Directive 2002/96/EU (WEEE)
  - NRTL approved (Product Safety)
  - FCC Listed (Radio Equipment)
- Standards:
  - Radio: EN 300 328, EN 301 893, EN 300 440 (only for the radio versions)
  - EMC: EN 301 489-1 & -17 (only for the radio versions), EN 55032 - Class A, EN 55024
  - Safety: EN 60950-1 (for radio and non-radio), EN 62479, EN 62311 (for the radio versions)
  - FCC CFR 47 Part 15B (EMC) - Class A
  - FCC CFR 47 Part 15C (RF)
  - FCC CFR 47 Part 15E (RF)

Please check the Product Approval Status Database at <http://www.cisco.com/go/psd> for approval documents per country.

All specifications are subject to change without notice, system specifics may vary.

All images in these materials are for representational purposes only, actual products may differ.

Cisco and the Cisco Logo are trademarks of Cisco Systems, Inc. and/or its affiliates in the U.S. and other countries. A listing of Cisco's trademarks can be found at [www.cisco.com/go/trademarks](http://www.cisco.com/go/trademarks). Third party trademarks mentioned are the property of their respective owners. The use of the word partner does not imply a partnership relationship between Cisco and any other company.

September 2018



## Supported RFCs

The RFC (Request for Comments) series contains technical and organizational documents about the Internet, including the technical specifications and policy documents produced by the Internet Engineering Task Force (IETF).

CE software supports a range of RFCs, including the following:

- RFC 2782 DNS RR for specifying the location of services (DNS SRV)
- RFC 3261 SIP: Session Initiation Protocol
- RFC 3263 Locating SIP Servers
- RFC 3361 DHCP Option for SIP Servers
- RFC 3550 RTP: A Transport Protocol for Real-Time Applications
- RFC 3711 The Secure Real-time Transport Protocol (SRTP)
- RFC 4091 The Alternative Network Address Types (ANAT) Semantics for the Session Description Protocol (SDP) Grouping Framework
- RFC 4092 Usage of the Session Description Protocol (SDP) Alternative Network Address Types (ANAT) Semantics in the Session Initiation Protocol (SIP)
- RFC 4582 The Binary Floor Control Protocol  
draft-ietf-bfcpbis-rfc4582bis-00 Revision of the Binary Floor Control Protocol (BFCP) for use over an unreliable transport
- RFC 4733 RTP Payload for DTMF Digits, Telephony Tones and Telephony Signals
- RFC 5245 Interactive Connectivity Establishment (ICE): A Protocol for Network Address Translator (NAT) Traversal for Offer/Answer Protocols
- RFC 5589: SIP Call Control Transfer
- RFC 5766 Traversal Using Relays around NAT (TURN): Relay Extensions to Session Traversal Utilities for NAT (STUN)
- RFC 5905 Network Time Protocol Version 4: Protocol and Algorithms Specification

## User documentation on the Cisco web site

Use the following short-links to find the documentation for the product series running CE software.

### Room Series:

▶ <https://www.cisco.com/go/roomkit-docs>

### MX Series:

▶ <https://www.cisco.com/go/mx-docs>

### SX Series:

▶ <https://www.cisco.com/go/sx-docs>

### DX Series:

▶ <https://www.cisco.com/go/dx-docs>

In general, you can find user documentation for all Cisco Collaboration endpoints at ▶ <https://www.cisco.com/go/telepresence/docs>

The documents are organized in the following categories – some documents are not available for all products:

### Install and Upgrade > Install and Upgrade Guides

- *Installation guides*: How to install the product
- *Getting started guide*: Initial configurations required to get the system up and running
- *RCSI guide*: Regulatory compliance and safety information

### Maintain and Operate > Maintain and Operate Guides

- *Getting started guide*: Initial configurations required to get the system up and running
- *Administrator guide*: Information required to administer your product
- *Deployment guide for TelePresence endpoints on CUCM*: Tasks to perform to start using the video system with the Cisco Unified Communications Manager (CUCM)
- *Spare parts overview, Spare parts replacement guides, Cable schemas*: Useful information when replacing spare parts

### Maintain and Operate > End-User Guides

- *User guides*: How to use the product
- *Quick reference guides*: How to use the product
- *Physical interface guide*: Details about the codec's physical interface, including the connector panel and LEDs

### Reference Guides > Command references

- *API reference guides*: Reference guide for the Application Programmer Interface (API)

### Reference Guides > Technical References

- *CAD drawings*: 2D CAD drawings with measurements

### Configure > Configuration Guides

- *CE Customization guide*: How to customize the user interface, how to use the video system's API to program in-room controls, making macros, use a video switch, and configure advanced audio set-ups using the Audio Console.

### Design > Design Guides

- *Video conferencing room guidelines*: General guidelines for room design and best practice
- *Video conferencing room guidelines*: Things to do to improve the perceived audio quality

### Software Downloads, Release and General Information > Licensing Information

- *Open source documentation*: Licenses and notices for open source software used in this product

### Software Downloads, Release and General Information > Release Notes

- *Software release notes*

## Cisco contacts

On our web site you will find an overview of the worldwide Cisco contacts.

Go to: ► <https://www.cisco.com/go/offices>

Corporate Headquarters  
 Cisco Systems, Inc.  
 170 West Tasman Dr.  
 San Jose, CA 95134 USA

### Intellectual property rights

THE SPECIFICATIONS AND INFORMATION REGARDING THE PRODUCTS IN THIS MANUAL ARE SUBJECT TO CHANGE WITHOUT NOTICE. ALL STATEMENTS, INFORMATION, AND RECOMMENDATIONS IN THIS MANUAL ARE BELIEVED TO BE ACCURATE BUT ARE PRESENTED WITHOUT WARRANTY OF ANY KIND, EXPRESS OR IMPLIED. USERS MUST TAKE FULL RESPONSIBILITY FOR THEIR APPLICATION OF ANY PRODUCTS.

THE SOFTWARE LICENSE AND LIMITED WARRANTY FOR THE ACCOMPANYING PRODUCT ARE SET FORTH IN THE INFORMATION PACKET THAT SHIPPED WITH THE PRODUCT AND ARE INCORPORATED HEREIN BY THIS REFERENCE. IF YOU ARE UNABLE TO LOCATE THE SOFTWARE LICENSE OR LIMITED WARRANTY, CONTACT YOUR CISCO REPRESENTATIVE FOR A COPY.

The Cisco implementation of TCP header compression is an adaptation of a program developed by the University of California, Berkeley (UCB) as part of UCB's public domain version of the UNIX operating system. All rights reserved. Copyright © 1981, Regents of the University of California.

NOTWITHSTANDING ANY OTHER WARRANTY HEREIN, ALL DOCUMENT FILES AND SOFTWARE OF THESE SUPPLIERS ARE PROVIDED "AS IS" WITH ALL FAULTS. CISCO AND THE ABOVE-NAMED SUPPLIERS DISCLAIM ALL WARRANTIES, EXPRESSED OR IMPLIED, INCLUDING, WITHOUT LIMITATION, THOSE OF MERCHANTABILITY, FITNESS FOR A PARTICULAR PURPOSE AND NONINFRINGEMENT OR ARISING FROM A COURSE OF DEALING, USAGE, OR TRADE PRACTICE.

IN NO EVENT SHALL CISCO OR ITS SUPPLIERS BE LIABLE FOR ANY INDIRECT, SPECIAL, CONSEQUENTIAL, OR INCIDENTAL DAMAGES, INCLUDING, WITHOUT LIMITATION, LOST PROFITS OR LOSS OR DAMAGE TO DATA ARISING OUT OF THE USE OR INABILITY TO USE THIS MANUAL, EVEN IF CISCO OR ITS SUPPLIERS HAVE BEEN ADVISED OF THE POSSIBILITY OF SUCH DAMAGES.

Any Internet Protocol (IP) addresses and phone numbers used in this document are not intended to be actual addresses and phone numbers. Any examples, command display output, network topology diagrams, and other figures included in the document are shown for illustrative purposes only. Any use of actual IP addresses or phone numbers in illustrative content is unintentional and coincidental.

All printed copies and duplicate soft copies are considered un-Controlled copies and the original on-line version should be referred to for latest version.

Cisco has more than 200 offices worldwide. Addresses, phone numbers, and fax numbers are listed on the Cisco website at [www.cisco.com/go/offices](http://www.cisco.com/go/offices).

Cisco and the Cisco logo are trademarks or registered trademarks of Cisco and/ or its affiliates in the U.S. and other countries. To view a list of Cisco trademarks, go to this URL: [www.cisco.com/go/trademarks](http://www.cisco.com/go/trademarks). Third-party trademarks mentioned are the property of their respective owners. The use of the word partner does not imply a partnership relationship between Cisco and any other company. (1110R)

### Cisco product security overview

This product contains cryptographic features and is subject to United States and local country laws governing import, export, transfer, and use. Delivery of Cisco cryptographic products does not imply third-party authority to import, export, distribute, or use encryption. Importers, exporters, distributors, and users are responsible for compliance with U.S. and local country laws. By using this product you agree to comply with applicable laws and regulations. If you are unable to comply with U.S. and local laws, return this product immediately.

Further information regarding U.S. export regulations may be found at <http://www.bis.doc.gov/policiesandregulations/ear/index.htm>.