



**This product has been  
discontinued**

Spec Sheet

# Cisco UCS C22 M3 High-Density Rack-Mount Server (Small Form Factor Hard Disk Drive Model)

CISCO SYSTEMS  
170 WEST TASMAN DR.  
SAN JOSE, CA, 95134  
[WWW.CISCO.COM](http://WWW.CISCO.COM)

#### PUBLICATION HISTORY

REV B.17    MARCH 14, 2016

---

# CONTENTS

<b>OVERVIEW</b> . . . . .	<b>3</b>
<b>DETAILED VIEWS</b> . . . . .	<b>4</b>
Chassis Front View . . . . .	4
Chassis Rear View . . . . .	5
<b>BASE SERVER STANDARD CAPABILITIES and FEATURES</b> . . . . .	<b>6</b>
<b>CONFIGURING the SERVER</b> . . . . .	<b>9</b>
STEP 1 VERIFY SERVER SKU . . . . .	10
STEP 2 SELECT CPU(s) . . . . .	11
STEP 3 SELECT MEMORY . . . . .	13
STEP 4 SELECT RAID CONFIGURATION . . . . .	17
STEP 5 SELECT DRIVES . . . . .	22
STEP 6 SELECT PCIe OPTION CARD(s) . . . . .	24
STEP 7 ORDER OPTIONAL NETWORK CARD ACCESSORIES . . . . .	26
STEP 8 SELECT AC POWER CORD(s) . . . . .	30
STEP 9 ORDER POWER SUPPLY . . . . .	33
STEP 10 ORDER OPTIONAL REVERSIBLE CABLE MANAGEMENT ARM . . . . .	34
STEP 11 ORDER A TRUSTED PLATFORM MODULE . . . . .	35
STEP 12 ORDER OPTIONAL USB 2.0 DRIVE . . . . .	36
STEP 13 SELECT OPERATING SYSTEM AND VALUE-ADDED SOFTWARE . . . . .	37
STEP 14 SELECT OPERATING SYSTEM MEDIA KIT . . . . .	40
STEP 15 SELECT SERVICE and SUPPORT LEVEL . . . . .	41
<b>OPTIONAL STEP - ORDER RACK(s)</b> . . . . .	<b>46</b>
<b>OPTIONAL STEP - ORDER PDU</b> . . . . .	<b>47</b>
<b>SUPPLEMENTAL MATERIAL</b> . . . . .	<b>48</b>
CHASSIS . . . . .	48
CPUs and DIMMs . . . . .	49
Physical Layout . . . . .	49
Memory Population Rules . . . . .	51
Recommended Memory Population . . . . .	52
Additional DIMM Populations . . . . .	53
Low-Voltage DIMM Considerations . . . . .	54
RAID Summary . . . . .	55
RAID Option ROM (OPROM) Settings . . . . .	56
RACKS . . . . .	57
PDUs . . . . .	59
Motherboard USB Port . . . . .	60
LED Indicators . . . . .	61
Front Panel . . . . .	61
Rear Panel . . . . .	63
<b>TECHNICAL SPECIFICATIONS</b> . . . . .	<b>65</b>
Dimensions and Weight . . . . .	65
Power Specifications . . . . .	65
Environmental Specifications . . . . .	67
Compliance Requirements . . . . .	68

## OVERVIEW

The Cisco® UCS C22 M3 small form factor (SFF) drive Rack Server combines economics and a density-optimized feature set from entry level enterprise to SMB with applications such as scale out, virtualization, IT and web infrastructure, VPN servers, file/print servers, and appliances.

Building on the success of the Cisco UCS C-Series Servers, the Cisco UCS C22 M3 server and the Cisco 1225 VIC further extend the capabilities of the Cisco UCS portfolio in a 1RU form factor with the addition of the Intel® Xeon® E5-2400 v2 and E5-2400 series processor family CPUs, which delivers the best combination of performance and efficiency gains. In addition, the Cisco UCS C22 M3 server offers 12 DIMM slots, up to eight disk drives, two PCIe slots and two 1 Gigabit Ethernet LAN-on-motherboard (LOM) ports that provide both price/performance in a compact 1U form factor.

Figure 1 Cisco UCS C22 M3 High-Density SFF Rack Server

### Front View

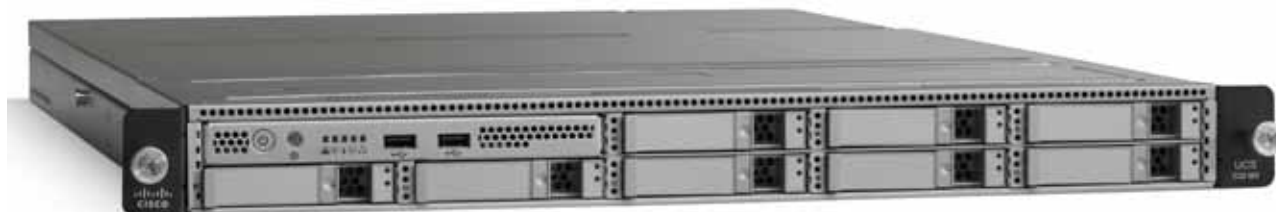

### Rear View



# DETAILED VIEWS

## Chassis Front View

Figure 2 shows the Cisco UCS C22 M3 High-Density SFF Rack Server.

Figure 2 Chassis Front View

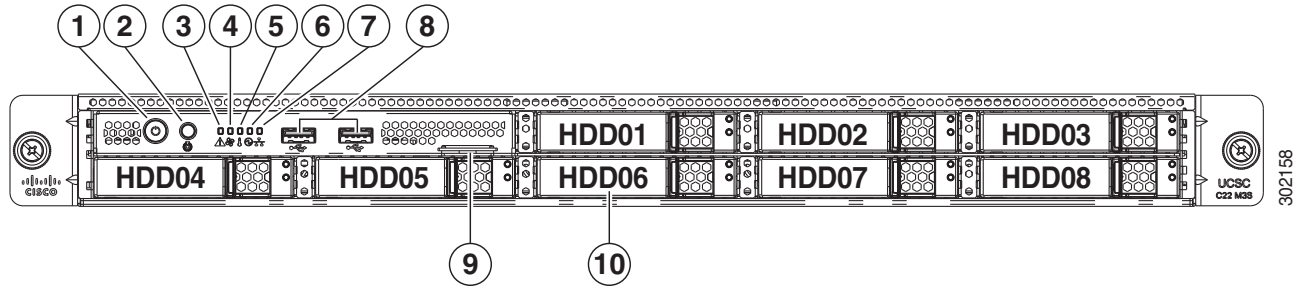

1	Power button/power status LED	6	Power supply status LED
2	Identification button/LED	7	Network link activity LED
3	System status LED	8	USB 2.0 ports (two)
4	Fan status LED	9	Pull-out asset tag
5	Temperature status LED	10	Drives (up to eight hot-swappable 2-5-inch drives)

## Chassis Rear View

Figure 3 shows the external features of the rear panel.

Figure 3 Chassis Rear View

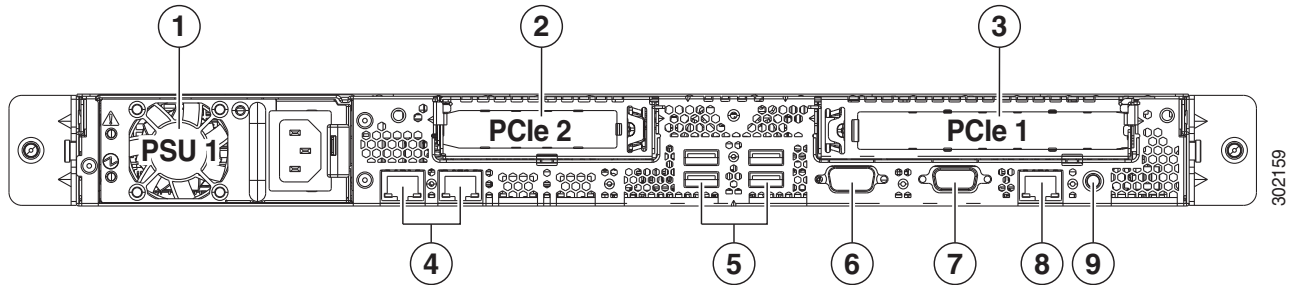

1	Power supply	6	Serial port (DB-9 connector)
2	Slot 2: Low-profile PCIe slot on riser 2 PCIe Gen 3 slot, x8, half-height, half-length	7	VGA video port (DB-15 connector)
3	Slot 1: Standard-profile PCIe slot on riser 1 PCIe Gen 3 slot, x16, full-height, half-length	8	10/100/1000 Base-T Ethernet dedicated management port
4	Dual 1-Gb Base-T Ethernet ports (two)	9	Rear Identification button/LED
5	USB 2.0 ports (four)	—	—

## BASE SERVER STANDARD CAPABILITIES and FEATURES

*Table 1* lists the capabilities and features of the base server. Details about how to configure the server for a particular feature or capability (for example, number of processors, disk drives, or amount of memory) are provided in *CONFIGURING the SERVER, page 9*.

Table 1 Capabilities and Features

Capability/Feature	Description
Chassis	Single rack unit (1RU) chassis
CPU	One or two Intel® Xeon E5-2400 v2 or E5-2400 series processor family CPUs
Chipset	Intel C600 chipset
Memory	12 DIMM slots
NIC	Embedded dual-port Intel I350 PCIe-based Gigabit Ethernet controller
Expansion slots	Two riser cards with one PCIe card slot in each riser <ul style="list-style-type: none"> <li>■ Riser 1 (controlled by CPU 1) <ul style="list-style-type: none"> <li>• Slot 1: PCIe Gen 3 slot, x16 extended connector (Cisco CNIC), half-length, full-height, with NCSI<sup>1</sup> and Cisco CNIC<sup>2</sup> support. The Cisco 1225 virtual interface card requires an NCSI slot.</li> </ul> </li> <li>■ Riser 2 (controlled by CPU 2) <ul style="list-style-type: none"> <li>• Slot 2: PCIe Gen 3 slot, x8 connector, half-length, half-height, no NCSI support</li> </ul> </li> </ul>
Internal storage devices	<ul style="list-style-type: none"> <li>■ Up to eight 2.5-inch SAS+SATA hot-swappable hard disk drives (HDDs) or solid state drives (SSDs)</li> <li>■ One connector on the motherboard that can accommodate a USB 2.0 drive. You can order an 8 or 16 GB drive for this connector and use it as a hypervisor or license dongle. The 8 or 16 GB USB drive comes blank.</li> </ul>
Video	<p>The Emulex Pilot 3 Integrated Baseboard Management Controller provides video:</p> <ul style="list-style-type: none"> <li>■ Matrox G200e video controller</li> <li>■ Integrated 2D graphics core with hardware acceleration</li> <li>■ Supports all display resolutions up to 1920 x 1200 x 16 bpp resolution at 60 Hz</li> <li>■ 24-bit color depth for all resolutions less than 1600x1200</li> <li>■ 8 MB video memory</li> </ul>

Capability/Feature	Description
Storage controller	<p>The following RAID options are available:</p> <ul style="list-style-type: none"> <li>■ Embedded RAID (3 Gbps) (these implementations of RAID do not consume a PCIe slot). <ul style="list-style-type: none"> <li>• Embedded SATA-only RAID controller, supporting up to four SATA-only drives (RAID 0, 1, 10), or</li> <li>• ROM5 RAID upgrade, supporting up to eight SAS+SATA drives (RAID 0, 1, 10), or</li> <li>• ROM55 RAID upgrade, supporting up to eight SAS+SATA drives (RAID 0, 1, 5, 10).</li> </ul> </li> <li>■ PCIe RAID controllers (these consume PCIe slots) <ul style="list-style-type: none"> <li>• LSI MegaRAID 9270CV-8i with 1 GB Transportable Memory Module (TMM) data cache and chassis-mounted (remote) supercap for data cache power backup, supporting RAID 0, 1, 5, 6, 10, 50, and 60 and up to eight internal SAS+SATA drives.</li> <li>• LSI MegaRAID 9240-8i RAID 8-port PCIe RAID controller, supporting RAID 0, 1, 5, 10, and 50 and up to eight internal SAS+SATA drives.</li> <li>• LSI MegaRAID 9220-8i RAID 8-port PCIe RAID controller supporting RAID 0, 1, and 10 and up to eight internal SAS+SATA drives.</li> </ul> </li> </ul>
Interfaces	<ul style="list-style-type: none"> <li>■ Rear panel <ul style="list-style-type: none"> <li>• One DB9 serial port connector</li> <li>• Four USB 2.0 port connectors</li> <li>• One DB15 VGA connector</li> <li>• One 10/100/1000 Ethernet management port</li> <li>• Two 1 GbE (10/100/1000 Mbps capable) Ethernet LOM ports</li> </ul> </li> <li>■ Front panel <ul style="list-style-type: none"> <li>• Two USB 2.0 ports</li> </ul> </li> </ul>
Front Panel	<ul style="list-style-type: none"> <li>■ A front panel controller provides status indications and control buttons</li> </ul>
Power subsystem	<p>One 450 W power supply or one 650 W power supply, depending on server configuration and loading. Prior to making a power supply selection, the UCS Power Calculator should be run to determine the right size power supply for your server configuration. A fully configured C22 M3 server may require the 650 W power supply. The UCS Power Calculator can be found at the following link:</p> <p><a href="http://ucspowercalc.cisco.com">http://ucspowercalc.cisco.com</a></p>
Fans	<p>Chassis:</p> <ul style="list-style-type: none"> <li>■ Five fans for front-to-rear cooling. N + 1 redundant.</li> </ul> <p>Power supply:</p> <ul style="list-style-type: none"> <li>■ The power supply is equipped with a fan.</li> </ul>

Capability/Feature	Description
Integrated management processor	Cisco Integrated Management Controller (CIMC). Depending on your CIMC settings, the CIMC can be accessed through the 1-Gb Ethernet dedicated management port, the 1-Gb Ethernet LOM ports, or a Cisco 1225 virtual interface card.

Notes . . .

1. NCSI = network communications services interface protocol. The slot stays active when the server is in standby power state.
2. CNIC = Cisco network interface card.



## CONFIGURING the SERVER

Follow these steps to configure the Cisco UCS C22 M3 High-Density SFF Rack Server:

- *STEP 1 VERIFY SERVER SKU, page 10*
- *STEP 2 SELECT CPU(s), page 11*
- *STEP 3 SELECT MEMORY, page 13*
- *STEP 4 SELECT RAID CONFIGURATION, page 17*
- *STEP 5 SELECT DRIVES, page 22*
- *STEP 6 SELECT PCIe OPTION CARD(s), page 24*
- *STEP 7 ORDER OPTIONAL NETWORK CARD ACCESSORIES, page 25*
- *STEP 8 SELECT AC POWER CORD(s), page 31*
- *STEP 9 ORDER POWER SUPPLY, page 34*
- *STEP 10 ORDER OPTIONAL REVERSIBLE CABLE MANAGEMENT ARM, page 35*
- *STEP 11 ORDER A TRUSTED PLATFORM MODULE, page 36*
- *STEP 12 ORDER OPTIONAL USB 2.0 DRIVE, page 37*
- *STEP 13 SELECT OPERATING SYSTEM AND VALUE-ADDED SOFTWARE, page 38*
- *STEP 14 SELECT OPERATING SYSTEM MEDIA KIT, page 41*
- *STEP 15 SELECT SERVICE and SUPPORT LEVEL, page 42*
- *OPTIONAL STEP - ORDER RACK(s), page 47*
- *OPTIONAL STEP - ORDER PDU, page 48*

## STEP 1 VERIFY SERVER SKU

Verify the product ID (PID) of the server as shown in [Table 2](#).

Table 2 PID of the C22 M3 High-Density SFF Rack Base Server

Product ID (PID)	Description
UCSC-C22-M3S	UCS C22 M3 SFF with rail kit, without PSU, CPU, memory, HDD, SSD, or PCIe cards

The Cisco C22 M3 server:

- Includes a rail kit (UCSC-RAIL1)
- Does not include power supply, CPU, memory, hard disk drives (HDDs), solid state drives (SSDs), or plug-in PCIe cards.



**NOTE:** Use the steps on the following pages to configure the server with the components that you want to include.

## STEP 2 SELECT CPU(s)

The standard CPU features are:

- Intel Xeon E5-2400 v2 or E5-2400 series processor family CPUs
- Intel C600 chipset
- Cache size of up to 25 MB

### Select CPUs

The available CPUs are listed in [Table 3](#).

Table 3 Available Intel CPUs: Xeon E5-24xx Family

Product ID (PID)	Intel Number	Clock Freq (GHz)	Power (W)	Cache Size (MB)	Cores	QPI (GT/s)	Highest DDR3 DIMM Clock Support (MHz) <sup>1</sup>
<b>Intel Xeon E5-2400 v2</b>							
UCS-CPU-E52470B	E52470 v2	2.4	95	25	10	8.0	1600
UCS-CPU-E52450B	E52450 v2	2.5	95	20	8	8.0	1600
UCS-CPU-E52440B	E52440 v2	1.9	95	20	8	7.2	1600
UCS-CPU-E52430B	E52430 v2	2.5	80	15	6	7.2	1600
UCS-CPU-E52430LB	E52430L v2	2.4	60	15	6	7.2	1600
UCS-CPU-E52420B	E52420 v2	2.2	80	15	6	7.2	1600
UCS-CPU-E52407B	E52407 v2	2.4	80	10	4	6.4	1333
UCS-CPU-E52403B	E52403 v2	1.8	80	10	4	6.4	1333
<b>Intel Xeon E5-2400</b>							
UCS-CPU-E5-2470	E5-2470	2.30	95	20	8	8.0	1600
UCS-CPU-E5-2450	E5-2450	2.10	95	20	8	8.0	1600
UCS-CPU-E5-2440	E5-2440	2.40	95	15	6	7.2	1333
UCS-CPU-E5-2430	E5-2430	2.20	95	15	6	7.2	1333
UCS-CPU-E5-2430L	E5-2430L	2.00	60	15	6	6.4	1333
UCS-CPU-E5-2420	E5-2420	1.90	95	15	6	7.2	1333
UCS-CPU-E5-2407	E5-2407	2.20	80	10	4	6.4	1066
UCS-CPU-E5-2403	E5-2403	1.80	80	10	4	6.4	1066

Notes . . .

1. If higher or lower speed DIMMs are selected than what is shown in the table for a given CPU, the DIMMs will be clocked at the lowest common denominator of CPU clock and DIMM clock.

### Approved Configurations

---

(1) 1-CPU configurations:

- Select any one CPU listed in [Table 3](#).

(2) 2-CPU Configurations:

- Select two identical CPUs from any one of the rows of [Table 3 on page 11](#).

### Caveats

---

- You can select either one CPU or two identical CPUs.
- If you select one CPU, only one PCIe slot (the full-height slot on riser 1) is available for use.
- For optimal performance, select DIMMs with the highest clock speed for a given processor (see [Table 3 on page 11](#)). If you select DIMMs whose speeds are lower or higher than that shown in the tables, suboptimal performance will result.

## STEP 3 SELECT MEMORY

The standard memory features are:

- DIMMs
  - Clock speed: 1600 or 1333 MHz
  - Ranks per DIMM: 1, 2, or 4
  - Operational voltage: 1.35 V or 1.5 V
  - Registered ECC DDR3 DIMMs (RDIMMs), unregistered DIMMs (UDIMMs), or load-reduced DIMMs (LRDIMMs)
- Memory is organized with three memory channels per CPU, with up to two DIMMs per channel, as shown in [Figure 4](#).

Figure 4 C22 M3 SFF Memory Organization

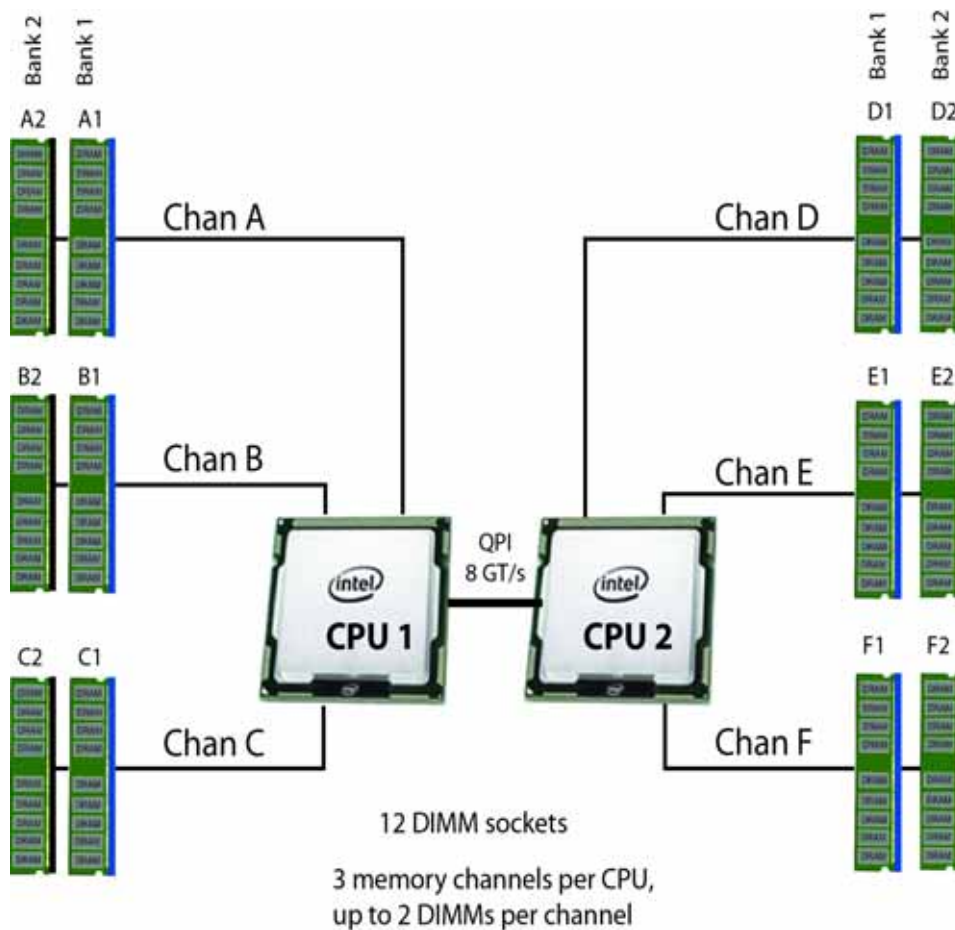

Select DIMMs

Select the memory configuration. The available memory DIMMs are listed in [Table 4](#).



**NOTE:** When memory mirroring is enabled, the memory subsystem simultaneously writes identical data to two channels. If a memory read from one of the channels returns incorrect data due to an uncorrectable memory error, the system automatically retrieves the data from the other channel. A transient or soft error in one channel does not affect the mirrored data, and operation continues unless there is a simultaneous error in exactly the same location on a DIMM and its mirrored DIMM. Memory mirroring reduces the amount of memory available to the operating system by 50% because only one of the two populated channels provides data.

Table 4 Available DDR3 DIMMs

Product ID (PID)	PID Description	Voltage	Ranks /DIMM
<b>DIMM Options</b>			
UCS-MR-1X041RY-A	4GB DDR3-1600-MHz RDIMM/PC3-12800/1R/x4/1.35v	1.35 V	1
UCS-MR-1X082RY-A	8GB DDR3-1600-MHz RDIMM/PC3-12800/2R/x4/1.35v	1.35 V	2
UCS-MR-1X162RY-A	16GB DDR3-1600-MHz RDIMM/PC3-12800/2R/x4/1.35v	1.35 V	2
UCS-ML-1X324RY-A	32GB DDR3-1600-MHz LR DIMM/PC3-12800/4R/x4/1.35v	1.35 V	4
<b>Memory Mirroring Option</b>			
N01-MMIRROR	Memory mirroring option		

## Approved Configurations

### (1) 1-CPU configuration without memory mirroring:

- Select from 1 to 6 DIMMs. Refer to [Memory Population Rules, page 52](#), for more detailed information.

### (2) 1-CPU configuration with memory mirroring:

- Select either 2 or 4 DIMMs. The DIMMs will be placed by the factory as shown in the following table:

Number of DIMMs	DIMM Placement in Channels (Channel A is not used with memory mirroring)
2	CPU 1: 1 DIMM in Channel B, 1 DIMM in Channel C
4	CPU 1: 2 DIMMs in Channel B, 2 DIMMs in Channel C

- Select the memory mirroring option (N01-MMIRROR) as shown in [Table 4 on page 14](#).

### (1) 2-CPU configuration without memory mirroring:

- Select from 1 to 6 DIMMs per CPU (2 to 12 DIMMs total). Refer to [Memory Population Rules, page 52](#), for more detailed information.

### (2) 2-CPU configuration with memory mirroring:

- Select 2 or 4 DIMMs per CPU (4 or 8 DIMMs total). The DIMMs will be placed by the factory as shown in the following table:

Number of DIMMs per CPU	DIMM Placement (Channels A and D are not used with memory mirroring)	
2	CPU 1: 1 DIMM in Channel B 1 DIMM in Channel C	CPU 2: 1 DIMM in Channel E 1 DIMM in channel F
4	CPU 1: 2 DIMMs in Channel B 2 DIMMs in Channel C	CPU 2: 2 DIMMs in Channel E 2 DIMMs in Channel F

- Select the memory mirroring option (N01-MMIRROR) as shown in [Table 4 on page 14](#).



**NOTE:** System performance is optimized when the DIMM type and quantity are equal for both CPUs.

## Caveats

---

- Do not mix 1333 MHz and 1600 MHz DIMMs
- Do not mix DIMM types (RDIMM, LRDIMM, or UDIMM)
- Do not select more than two different types of DIMMs (only two PID types allowed)
- For 2-CPU configurations, install a minimum of 2 DIMMs (one per CPU).
- If you use different sizes of DIMMs, the quantity of each size of DIMM must be even (2, 4, or 6). For example, 4 UCS-MR-1X082RY-A DIMMs and 6 UCS-MR-1X162RY-A DIMMs. Also, the sum of all PIDs must adhere to the maximum quantity rule of 12 DIMMs for 2-CPU systems.
- By default, all DIMMs run at 1.35 V, which yields 1333-MHz memory speeds. To run the memory DIMMs at 1600 MHz, you need to go into the BIOS or set the policy with UCSM (service profile) to run in Performance Mode. This forces the DIMMs to operate at 1.5 V and yields 1600-MHz speeds, provided:
  - The DIMMs are 1600-MHz devices
  - The CPUs chosen support 1600-MHz operation.



**NOTE:** 32 GB LRDIMMs run at a maximum speed of 1333 MHz for 1 DPC and 2 DPC even though their specified maximum speed is 1600 MHz.

---



**NOTE:** In this server, 4 GB UDIMMs run slower than their specified maximum speed of 1600 MHz. In addition, the following rules apply to UDIMMs:

- 1 DPC: 1333 MHz is supported at 1.35 V and 1.5 V
  - 2 DPC: 1066 MHz is supported at 1.35 V and 1.5 V
- 

For more information regarding memory, see [CPUs and DIMMs, page 50](#).



## STEP 4 SELECT RAID CONFIGURATION



NOTE: If you do not select a PCIe RAID controller or one of the embedded RAID upgrade options, you will have an embedded SATA-only RAID controller that supports up to four SATA-only drives (RAID 0, 1, 10)



NOTE: When creating a RAID volume, follow these guidelines:

- Use the same capacity for each drive in the volume
- Use either all SAS drives or all SATA drives
- Use either all HDDs or all SSDs



NOTE: The number of RAID groups (virtual drives) supported per controller is as follows (note however, that this server can have a maximum of only eight internal physical drives):

- LSI MegaRAID SAS 9270CV-8i RAID controller card = 64
- LSI MegaRAID 9240-8i RAID controller card = 16
- LSI MegaRAID 9220-8i RAID controller card = 16

The RAID controller choices are:

### (1) Embedded RAID (on motherboard)



NOTE: Embedded RAID is not available with VMWare.



NOTE: The RAID configuration options listed in [Table 6 on page 18](#) are not available if you choose embedded RAID (in this case, you must configure RAID yourself using separate software).

### (2) PCIe RAID controllers

Cisco can provide factory-configured RAID systems depending on the RAID controller chosen and the number of drives ordered. Factory-configured RAID options are listed with each RAID card description.

RAID levels 50 and 60 are supported, although they are not available as factory-configured RAID options.

Select RAID Options

Select one RAID controller (either embedded RAID in [Table 5](#) or hardware RAID using a PCIe RAID controller and an appropriate RAID configuration option listed in [Table 6 on page 18](#)).

Table 5 Available Embedded RAID (LSI MegaSR) Options

Product ID (PID)	PID Description
<b>Embedded RAID</b>	
UCSC-RAID-ROM5	Onboard RAID, consisting of a plug-in storage controller unit (SCU), supporting up to 8 internal SAS +SATA drives. SAS and SATA drives can be mixed. This option supports RAID 0, 1, and 10, and operates at 3 Gb/s. Operating systems supported are Windows and Linux only (no VMware support).
UCSC-RAID-ROM55	Onboard RAID, consisting of two plug-in modules (an SCU plus a software key module) supporting up to 8 internal SAS+SATA drives. SAS and SATA drives can be mixed. This option supports RAID 0, 1, 5, and 10 and operates at 3 Gb/s. Operating systems supported are Windows and Linux only (no VMware support).



**NOTE:** VMware ESX/ESXi or any other virtualized environments are not supported for use with the embedded MegaRAID controller. Hypervisors such as Hyper-V, Xen, or KVM are also not supported for use with the embedded MegaRAID controller

Table 6 Available Hardware RAID Options

Product ID (PID)	PID Description
<b>RAID Controllers</b>	
Note that PCIe RAID controllers are installed by default in slot 1 for 1-CPU systems and slot 2 for 2-CPU systems	
UCSC-RAID-9240-8i	LSI MegaRAID 9240-8i <ul style="list-style-type: none"> <li>■ Supports up to 8 internal SAS+SATA drives. SAS and SATA drives can be mixed.</li> <li>■ RAID levels supported: RAID 0, 1, 5, 10, 50 (see the RAID Configuration Options section later in this table)</li> </ul>
UCSC-RAID-9220-8i	LSI MegaRAID 9220-8i <ul style="list-style-type: none"> <li>■ Supports up to 8 internal SAS+SATA drives. SAS and SATA drives can be mixed.</li> <li>■ RAID levels supported: RAID 0, 1, 10 (see the RAID Configuration Options section later in this table)</li> </ul>

Table 6 Available Hardware RAID Options (*continued*)

Product ID (PID)	PID Description
UCS-RAID9270CV-8i	LSI MegaRAID 9270CV-8i (with supercap power backup) <ul style="list-style-type: none"> <li>■ Supports up to 8 internal SAS+SATA drives. SAS and SATA drives can be mixed.</li> <li>■ Includes a 1 GB Transportable Memory Module (TMM) cache and chassis-mount (remote) supercap power module for data cache backup</li> <li>■ RAID levels supported: RAID 0, 1, 5, 6, 10, 50, 60 (see the RAID Configuration Options section later in this table)</li> </ul>
<b>RAID Configuration Options (not available for embedded RAID)</b>	
R2XX-RAID0	Factory preconfigured RAID striping option Enable RAID 0 Setting. Requires a minimum of one hard drive.
R2XX-RAID1	Factory preconfigured RAID mirroring option Enable RAID 1 Setting. Requires exactly two drives with the same size, speed, capacity.
R2XX-RAID5	Factory preconfigured RAID option Enable RAID 5 Setting. Requires a minimum of three drives of the same size, speed, capacity.
R2XX-RAID6	Factory preconfigured RAID option Enable RAID 6 Setting. Requires a minimum of four drives of the same size, speed, capacity.
R2XX-RAID10	Factory preconfigured RAID option Enable RAID 10 Setting. Requires an even number of drives (minimum of four drives) of the same size, speed, capacity.



**NOTE:** Although RAID levels 50 and 60 are not orderable from the factory, they are supported for selected controllers as shown in [Table 6](#).

---

## Approved Configurations

---

### (1) 1-CPU Configurations

Select an embedded RAID option from [Table 5 on page 18](#) or one PCIe RAID controller from [Table 6 on page 18](#). You may also select an appropriate optional RAID configuration listed in [Table 6 on page 18](#).



**NOTE:** In 1-CPU configurations, PCIe slot 1 is the default slot supported for an internal drive RAID controller. PCIe slot 2 is not supported for 1-CPU systems.

---



**NOTE:** If you do not select a PCIe RAID controller or one of the embedded RAID upgrade options from [Table 5 on page 18](#), you will have an embedded SATA-only RAID controller that supports up to four SATA-only drives (RAID 0, 1, 10) and slot 1 can be used for a PCIe RAID controller (see [Table 8 on page 24](#)).

---

### (2) 2-CPU Configurations

Select an embedded RAID option from [Table 5 on page 18](#), or one PCIe RAID controller from [Table 6 on page 18](#). You may also select an appropriate optional RAID configuration listed in [Table 6 on page 18](#).



**NOTE:** In 2-CPU configurations, PCIe slot 2 is the default slot supported for an internal drive RAID controller. PCIe slot 1 can be used for a PCIe expansion card (including the VIC card). You can change the default card slot for a RAID controller to slot 1 by going into the BIOS and reconfiguring the option ROM (OPROM) settings. Keep in mind, however, that if you use slot 1 for a RAID controller, you will not be able to install a VIC card, which can be installed only in slot 1.

---



**NOTE:** If you do not select a PCIe RAID controller, or one of the embedded RAID upgrade options from [Table 5 on page 18](#), you will have an embedded SATA-only RAID controller that supports up to four SATA-only drives (RAID 0, 1, 10) and slots 1 and 2 can be used for PCIe cards (see [Table 8 on page 24](#)).

---

## Caveats

---

- In 1-CPU configurations, there is only one full-height PCIe slot available (located on riser 1). Slot 2 is not supported in 1-CPU systems.
  - If you choose embedded RAID, you can select one optional PCIe card from [Table 8 on page 24](#) to be installed in slot 1.
  - If you choose a PCIe RAID controller from [Table 5 on page 18](#), it will be installed in slot 1 by default and you will not be able to select any optional PCIe card from [Table 8 on page 24](#).

- Note that only a single Cisco 1225 Virtual Interface Card (VIC) card is supported and it must be installed in the full-length, full-height PCIe slot (slot 1) on riser 1, which is the only slot that supports NCSI. So take this into account when populating RAID controller cards. You can have either a PCIe RAID controller or a VIC card in slot 1.
- Slot 2 is not supported in 1-CPU systems.
- In 2-CPU configurations, there are two PCIe slots available (one full-height slot, slot 1, and one half-height slot, slot 2).
  - If you choose embedded RAID, you can select up to two optional PCIe cards from [Table 8 on page 24](#) to be installed in slots 1 and 2.
  - If you choose a PCIe RAID controller from [Table 5 on page 18](#), it will be installed in slot 2 by default and you will be able to select one additional optional PCIe card from [Table 8 on page 24](#) to be installed in slot 1.
- The optional PCIe RAID controllers are all half-height. If you choose one of these cards in a 2-CPU configuration, only the full-height PCIe card slot will be available for an additional optional PCIe card.
- Note that only a single Cisco UCS 1225 Virtual Interface Card (VIC) card is supported and it must be installed in the full-length, full-height PCIe slot (slot 1) on riser 1, which is the only slot that supports NCSI. So take this into account when populating RAID controller cards.
- You can choose only one type of RAID controller, either embedded RAID or a PCIe RAID controller. If you choose embedded RAID, slot 1 in a 1-CPU system and slots 1 and 2 in a 2-CPU system are available for adding optional PCIe cards.
- For PCIe RAID controllers, you can choose an optional RAID configuration (RAID 0, 1, 5, 6, or 10), which is preconfigured at the factory. The RAID level you choose must be an available RAID choice for the controller selected. RAID levels 50 and 60 are supported, depending on the RAID controller selected, although they are not available as configuration options.



NOTE: For more important information regarding RAID support, see [RAID Summary, page 56](#) and [RAID Option ROM \(OPROM\) Settings, page 57](#).

---

## STEP 5 SELECT DRIVES

The standard disk drive features are:

- 2.5-inch small form factor
- Hot-pluggable
- Sled-mounted

### Select Drives

The available drives are listed in [Table 7](#).

Table 7 Available Hot-Pluggable Sled-Mounted HDDs or SSDs

Product ID (PID)	PID Description	Drive Type	Capacity
<b>HDDs</b>			
UCS-HDD250G1F111	250 GB 6Gb SATA 7.2K RPM	SATA	250 GB
UCS-HDD300G12F105	300 GB 6Gb SAS 15K RPM SFF	SAS	300 GB
A03-D300GA2	300 GB 6Gb SAS 10K RPM SFF	SAS	300 GB
A03-D500GC3	500 GB SATA 7.2K RPM SFF	SATA	500 GB
A03-D600GA2	600 GB 6Gb SAS 10K RPM SFF	SAS	600 GB
UCS-HDD900G12F106	900 GB 6Gb SAS 10K RPM SFF	SAS	600 GB
A03-D1TBSATA	1 TB SATA 7.2K RPM SFF	SATA	1 TB
<b>SSDs</b>			
UCS-SD200G0KS2-EP	200 GB 2.5 inch Enterprise Performance SAS	SAS	200 GB
UCS-SD400G0KS2-EP	400 GB 2.5 inch Enterprise Performance SAS	SAS	400 GB
UCS-SD800G0KS2-EP	800 GB 2.5 inch Enterprise Performance SAS	SAS	800 GB
UCS-SD480G0KS2-EV	480 GB 2.5 inch Enterprise Value 6 G SATA SSD	SATA	480 GB
UCS-SD240G0KS2-EV	240 GB 2.5 inch Enterprise Value 6 G SATA SSD	SATA	240 GB
UCS-SD120G0KS2-EV	120 GB 2.5 inch Enterprise Value 6 G SATA SSD	SATA	120 GB
UCS-SD100G0KA2-G	100 GB Read SSD	SATA	100 GB
UCS-SD400G0KA2-G	400 GB Read SSD	SATA	400 GB



---

NOTE: When creating a RAID volume, follow these guidelines:

- Use the same capacity for each drive in the volume
  - Use either all SAS drives or all SATA drives
  - Use either all HDDs or all SSDs
- 



---

NOTE: The number of RAID groups (virtual drives) supported per controller is as follows:

- LSI MegaRAID SAS 9270CV-8i RAID controller card = 64
  - LSI MegaRAID 9240-8i RAID controller card = 16
  - LSI MegaRAID 9220-8i RAID controller card = 16
- 

### Approved Configurations

---

#### (1) Embedded RAID (LSI MegaSR)

- Select up to eight SAS/SATA drives (note that none of the RAID configuration options listed in [Table 6 on page 18](#) can be chosen for embedded RAID). You can mix SAS and SATA drives.

#### (2) LSI MegaRAID 9270CV-8i (with data cache and supercap), LSI MegaRAID 9240-8i, and LSI MegaRAID 9220-8i

- Select up to eight SAS/SATA drives listed in [Table 7 on page 22](#). You can mix SAS and SATA drives.

#### (3) None of the Above

- If you did not select embedded RAID or a PCIe RAID controller, you can only select up to four SATA drives, which will be controlled by the embedded SATA-only RAID controller.

### Caveats

---

- You can mix SATA and SAS drives
- If you select one or more SAS drives, you must select either a PCIe RAID controller from [Table 6 on page 18](#) or an embedded RAID option from [Table 5 on page 18](#).
- If you select four or less SATA-only drives, you can select a PCIe RAID controller from [Table 6 on page 18](#) or an embedded RAID option from [Table 5 on page 18](#), or neither. If you select neither, the drives will be controlled by the embedded SATA-only RAID controller.

## STEP 6 SELECT PCIe OPTION CARD(s)

The standard PCIe card offerings are:

- Converged Network Adapters (CNAs)
- Network Interface Cards (NICs)
- Host Bus Adapters (HBAs)

### Select PCIe Option Cards

The available PCIe option cards are listed in [Table 8](#).

Table 8 Available PCIe Option Cards

Product ID (PID)	PID Description	Card Height
<b>Converged Network Adapters (CNAs)</b>		
UCSC-PCIE-CSC-02	Cisco VIC 1225 Dual Port 10Gb SFP+ CNA	Half
UCSC-PCIE-C10T-02	Cisco VIC 1225T Dual Port 10GBaseT CNA	Half
UCSC-PCIE-C40Q-02	Cisco VIC 1285 Dual Port 40Gb QSFP CNA	Half
UCSC-PCIE-ESFP	Emulex OCe11102-FX dual-port 10 GbE FCoE CNA	Half
UCSC-PCIE-Q8362	Qlogic QLE8362 dual-port 10 GbE FCoE CNA	Half
<b>Network Interface Cards (NICs)</b>		
N2XX-ABPCI01-M3	Broadcom 5709 Dual-Port Ethernet PCIe Adapter w/TOE for M3 Servers	Half
N2XX-ABPCI03-M3	Broadcom 5709 Quad Port 10/100/1Gb NIC w/TOE iSCSI for M3 Servers	Half
UCSC-PCIE-BTG	Broadcom 57712 Dual Port 10GbE 10G-BaseT w/TOE	Half
N2XX-AIPCI01	Intel 10GbE 2-Port Niantec Controller with Copper SFP+ Cable	Half
UCSC-PCIE-IRJ45	Intel Quad Port GbE controller (this is a quad-port i350 controller)	Half
UCSC-PCIE-ITG	Intel X540 Dual Port 10GBase-T Adapter	Half
UCSC-PCIE-B3SFP	BROADCOM 57810 10Gb AFEX SFP+	Half
<b>Host Bus Adapters (HBAs)</b>		
N2XX-AEPCI03	Emulex LPe 11002, 4Gb Fibre Channel PCIe Dual Channel HBA	Half
N2XX-AEPCI05	Emulex LPe 12002, 8Gb dual port Fibre Channel HBA	Half
N2XX-AQPCI03	Qlogic QLE2462, 4Gb dual port Fibre Channel HBA	Half
N2XX-AQPCI05	Qlogic QLE2562, 8Gb dual port Fibre Channel HBA	Half
UCSC-PCIE-Q2672	Qlogic QLE2672-CSC, 16Gb Fibre Channel HBA with SR Optics	Half
UCSC-PCIE-E16002	Emulex LPe16002-M6, 16Gb Fibre Channel HBA with SR Optics	Half



## Approved Configurations

---

### (1) No PCIe RAID controller

- If you did not choose a PCIe RAID controller (for example, you selected embedded RAID (LSI MegaSR) or no RAID controller at all), you can select up to one PCIe option card listed in [Table 8 on page 24](#) for 1-CPU configurations or up to two cards for 2-CPU configurations.

### (2) One PCIe RAID controller

- If you selected a PCIe RAID controller, you cannot select any additional PCIe cards for 1-CPU configurations; however, you can select one additional optional PCIe card for 2-CPU configurations.



**NOTE:** If a PCIe RAID controller is installed, any optional PCIe card you select will be installed in the full-height slot. RAID controllers are always installed in the half-height slot (unless you change the OPROM setting to enable the full-height slot, slot 1) for RAID.

## Caveats

---

- Only a single Cisco UCS 1225 Virtual Interface Card (VIC) card is supported and it must be installed in the full-height slot of riser 1, which is the only slot that supports NCSI.
- All PCIe cards will fit in either riser 1 or riser 2, except the VIC card, which must be installed in the full-height slot of riser 1. The Cisco 1225 VIC card must be plugged into slot 1, which supports NCSI.
- Additional considerations for the Cisco 1225 VIC card:
  - Supports 10G SFP+ optical and copper twinax connections
  - The server supports installation of only one Cisco VIC 1225 card and it is supported only in PCIe slot 1. Slot 1 can operate while the server is in standby power mode.
  - Requires that the server has CIMC firmware version 1.4(6) or later installed. There is a heartbeat LED on the top of the card that indicates when firmware is active.
  - To use this card for UCS integration (Cisco UCS Manager mode) with Cisco UCS Manager 2.1(0) or later, the minimum card-firmware and uboot image level is 2.1(0.306).
- To help ensure that your operating system is compatible with the card you have selected, check the Hardware Compatibility List at this URL:

[http://www.cisco.com/en/US/products/ps10477/prod\\_technical\\_reference\\_list.html](http://www.cisco.com/en/US/products/ps10477/prod_technical_reference_list.html)

## STEP 7 ORDER OPTIONAL NETWORK CARD ACCESSORIES

Copper twinax cables and SFP optical modules may be ordered to support the two-port network cards that are available with the server.

### Choose Optional Twinax Cables

---

[Table 9](#) lists the copper twinax cables available for the PCIe cards. You can choose cable lengths of 1, 3, 5, 7, or 10 meters. The two longer cables (7 and 10 meters) are active, which means that they contain active components within the SFP+ housing to improve signal quality.

Table 9 Available Twinax Cables

Product ID (PID)	PID Description
SFP-H10GB-CU1M	10GBASE-CU SFP+ Cable (1 M)
SFP-H10GB-CU3M	10GBASE-CU SFP+ Cable (3 M)
SFP-H10GB-CU5M	10GBASE-CU SFP+ Cable (5 M)
SFP-H10GB-ACU7M	10GBASE-CU SFP+ Cable (7 M)
SFP-H10GB-ACU10M	10GBASE-CU SFP+ Cable (10 M)

---

### Approved Configurations

---

(1) Choose Up to Two Twinax Cables for Each Network Card Ordered

- You may choose one or two twinax cables for each compatible PCIe network card ordered. The cables can be different lengths; however, you would normally order two cables of equal lengths to connect to the primary and redundant network switching equipment.

### Choose Optional SFP Modules

---

Optical Cisco SFP+ modules are listed in [Table 10](#).

Table 10 Available SFP Modules

Product ID (PID)	PID Description
SFP-10G-SR	10GBASE-SR SFP+ Module 850 nm, multimode, SR, 3.3V, LC connector, with Digital Optical Monitoring
SFP-10G-LR	10GBASE-LR SFP+ Module 1310 nm, single mode, LR, 3.3 V, with Digital Optical Monitoring
DS-SFP-FC8G-SW	8 Gbit SFP+ Module 850 nm, multimode, SR, 3.3V, LC connector, with Digital Optical Monitoring

---

### Approved Configurations

---

(1) Choose Up to Two SFP+ Modules for Each Network Card Ordered

- You may choose one or two SFP+ optical modules cables for each compatible PCIe network card ordered. You would normally order two modules for connecting to the primary and redundant network switching equipment. With the SFP+ optical modules, you can use common fiber optic cables, widely available.

See the [Figure 5 on page 30](#) for typical SFP+ and twinax connections to the network cards.

### Caveats

---

Check the table on the following page for compatibility between the PCIe network cards and SFPs or twinax cables.



**NOTE:** The table shows all PCIe network cards for all C-series servers. Not all of the cards shown in the table are supported in this server. The intent of the table is to show compatibility between cards and twinax cables or SFPs.

---

Table 11 PCIe Card Compatibility

PCIe Cards	Twinax Cables	Cisco SFP Modules		
		SFP-10G-SR	SFP-10G-LR	DS-SFP-FC8G-SW
<b>Converged Network Adapters (CNAs)</b>				
UCSC-PCIE-BSFP (Broadcom 57712 Dual Port 10Gb SFP+ w/TOE iSCSI)	Yes	Yes	No	
UCSC-PCIE-CSC-02 (Cisco VIC 1225 Dual Port 10Gb SFP+ CNA)	Yes	Yes	Yes	No
UCSC-PCIE-C10T-02 (Cisco VIC 1225T Dual Port 10GBaseT CNA)	No	No	No	No
UCSC-MLOM-CSC-02 (Cisco UCS VIC1227 VIC MLOM - Dual Port 10Gb SFP+)	Yes	Yes	Yes	No
UCSC-MLOM-C10T-02 (Cisco UCS VIC1227T VIC MLOM - Dual Port 10GBaseT)	No	No	No	No
UCSC-PCIE-C40Q-02 (Cisco VIC 1285 Dual Port 40Gb QSFP CNA)	Yes	No <sup>1</sup>	No	
UCSC-PCIE-C40Q-03 (Cisco VIC 1385 Dual Port 40Gb QSFP+ CNA w/RDMA)	Yes	No <sup>1</sup>	No	
UCSC-PCIE-ESFP (Emulex OCe11102-FX dual-port 10 GbE FCoE CNA (Gen 3 CNA))	Yes	Yes	No	
UCSC-PCIE-QSFP (QLogic QLE8242-CU dual-port 10 GbE FCoE CNA)	Yes	Use Qlogic SFP		
UCSC-PCIE-B3SFP (Broadcom 57810 10Gb A-FEX SFP+)	Yes	Yes	No	
UCSC-PCIE-Q8362 (Qlogic QLE8362 dual-port 10 GbE FCoE CNA)	Yes	Use Qlogic SFP		
UCSC-PCIE-E14102 (Emulex OCe14102-UX dual-port 10 GbE FCoE CNA)	Yes	Yes	No	
<b>Network Interface Cards (NICs)</b>				
N2XX-ABPCI01-M3 (Broadcom 5709 Dual-Port Ethernet PCIe Adapter for M3 Servers)	Use RJ45 Ethernet cable			
N2XX-ABPCI03-M3 (Broadcom 5709 Quad Port 10/100/1Gb NIC w/TOE iSCSI for M3 Servers)	Use RJ45 Ethernet cable			
N2XX-AIPCI01 (Intel X520 Dual Port 10Gb SFP+ Adapter)	Yes	Use Intel SFP CDE2-SFP-1WLR or CDE2-SFP-1WSR		
UCSC-PCIE-ITG (Intel X540 Dual Port 10GBase-T Adapter)	Use RJ45 Ethernet cable			
UCSC-PCIE-IRJ45 (Intel i350 Quad Port 1Gb Adapter)	Use RJ45 Ethernet cable			

Table 11 PCIe Card Compatibility (*continued*)

PCIe Cards	Twinax Cables	Cisco SFP Modules		
		SFP-10G-SR	SFP-10G-LR	DS-SFP-FC8G-SW
UCSC-PCIE-BTG (Broadcom 57712 Dual Port 10GBASE-T w/TOE iSCSI)	Yes	No	No	
Host Bus Adapters (HBAs)				
N2XX-AEPCI03 (Emulex LPe 11002 Dual Port 4Gb Fibre Channel HBA)	No	Preinstalled - do not change SFP		
N2XX-AEPCI05 (Emulex LPe 12002 Dual Port 8Gb Fibre Channel HBA)	No	Preinstalled - do not change SFP		
N2XX-AQPCI03 (QLogic QLE2462 Dual Port 4Gb Fibre Channel HBA)	No	Preinstalled - do not change SFP		
N2XX-AQPCI05 (QLogic QLE2562 Dual Port 8Gb Fibre Channel HBA)	No	Preinstalled - do not change SFP		
UCSC-PCIE-Q2672 (QLogic QLE2672-CSC, 16Gb Fibre Channel HBA with SR Optics)	No	Preinstalled - do not change SFP		
UCSC-PCIE-E16002 (Emulex LPe16002-M6, 16Gb Fibre Channel HBA with SR Optics)	No	Preinstalled - do not change SFP		

Notes . . .

1. This card supports a 4x10 Gbps QSFP to SFP breakout fiber cable.

Figure 5 Network Card Connections

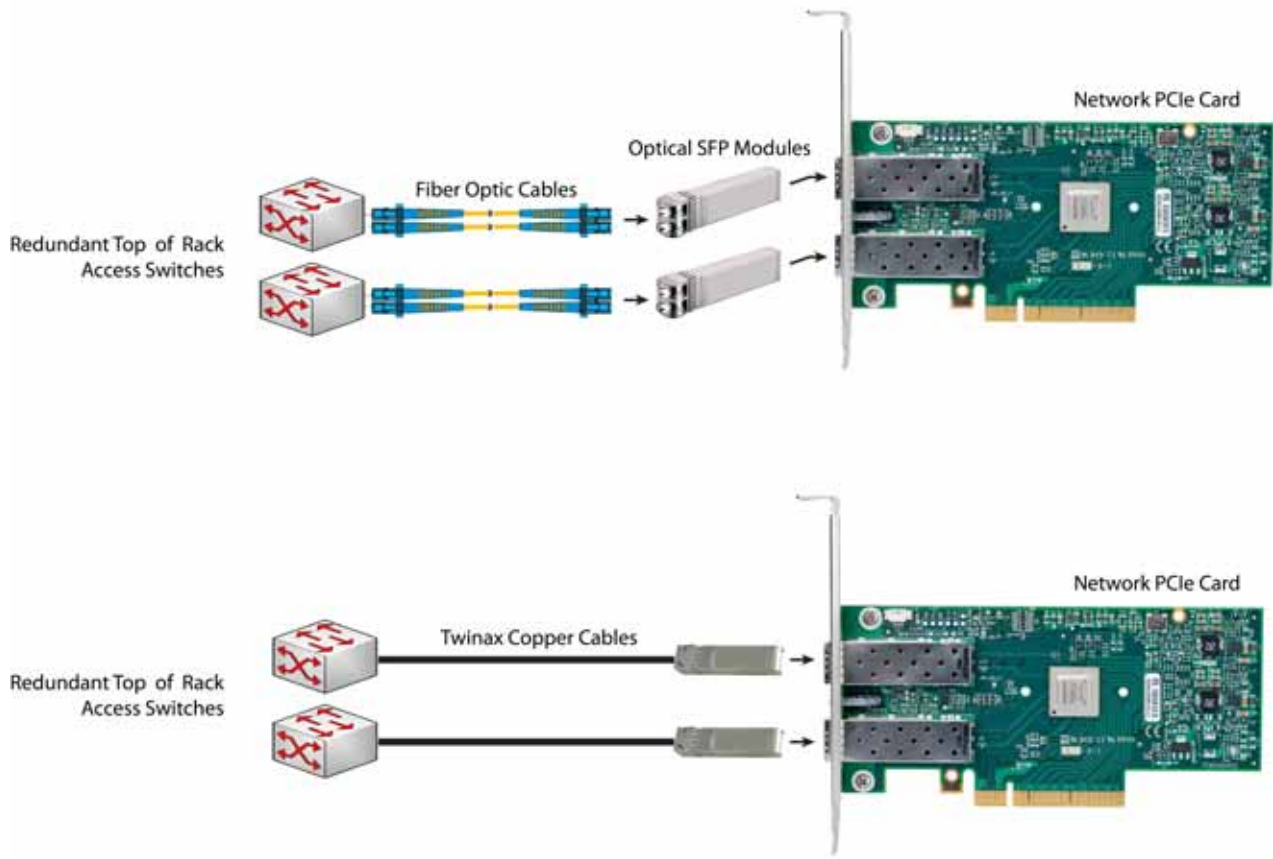

## STEP 8 SELECT AC POWER CORD(S)

Using [Table 12](#), select the appropriate AC power cords. You can select a minimum of no power cords and a maximum of two. If you select the option R2XX-DMYMPWRCORD, no power cord is shipped with the server.

Table 12 Available Power Cords

Product ID (PID)	PID Description	Images
R2XX-DMYMPWRCORD	No power cord (dummy PID to allow for a no power cord option)	Not applicable
CAB-N5K6A-NA	Power Cord, 200/240V 6A, North America	
CAB-AC-L620-C13	AC Power Cord, NEMA L6-20 - C13, 2M/6.5ft	
CAB-C13-CBN	CABASY,WIRE,JUMPER CORD, 27" L, C13/C14, 10A/250V	
CAB-C13-C14-2M	CABASY,WIRE,JUMPER CORD,PWR, 2 Meter, C13/C14, 10A/250V	
CAB-C13-C14-AC	CORD,PWR,JMP,IEC60320/C14,IEC60320/C13, 3.0M	

Table 12 Available Power Cords

Product ID (PID)	PID Description	Images
CAB-250V-10A-AR	Power Cord, SFS, 250V, 10A, Argentina	<p>Plug: EL 219 (IRAM 2073)</p> <p>Cordset rating: 10 A, 250/500 V MAX Length: 8.2 ft</p> <p>Connector: EL 701 (IEC60320/C13)</p>
CAB-9K10A-AU	Power Cord, 250VAC 10A 3112 Plug, Australia	<p>Plug: EL 210 (BS 1363A) 13 AMP fuse</p> <p>Cordset rating: 10 A, 250 V/500 V MAX Length: 2500mm</p> <p>Connector: EL 701C (EN 60320/C15)</p>
CAB-250V-10A-CN	Power Cord, SFS, 250V, 10A, China	<p>Plug: EL 218 (CCEE GB2009)</p> <p>Cordset rating 10A, 250V (2500 mm)</p> <p>Connector: EL 701 (IEC60320/C13)</p>
CAB-250V-10A-CN	AC Power Cord - 250V, 10A - PRC	<p>Plug: EL 218 (CCEE GB2009)</p> <p>Cordset rating 10A, 250V (2500 mm)</p> <p>Connector: EL 701 (IEC60320/C13)</p>
CAB-9K10A-EU	Power Cord, 250VAC 10A CEE 7/7 Plug, EU	<p>Plug: M2511</p> <p>Cordset rating: 10A/16 A, 250 V Length: 8 ft 2 in. (2.5 m)</p> <p>Connector: VSCC15</p>
CAB-250V-10A-ID	Power Cord, SFS, 250V, 10A, India	<p>Plug: EL 208</p> <p>Cordset rating 16A, 250V (2500mm)</p> <p>Connector: EL 701</p>
CAB-250V-10A-IS	Power Cord, SFS, 250V, 10A, Israel	<p>Plug: EL 212 (SI-32)</p> <p>Cordset rating 10A, 250V/500V MAX (2500 mm)</p> <p>Connector: EL 701B (IEC60320/C13)</p>

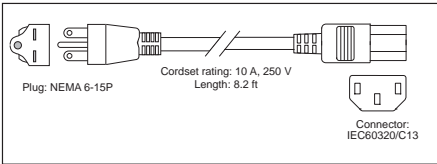
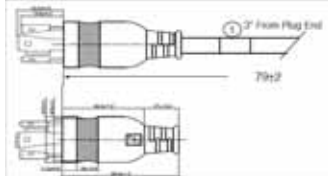
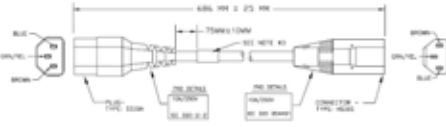
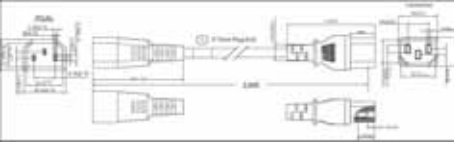
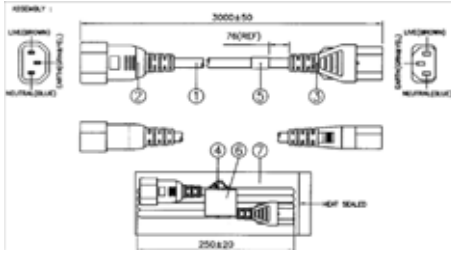
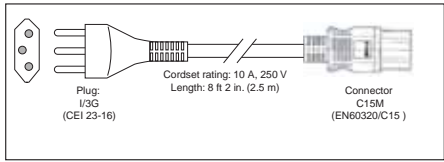
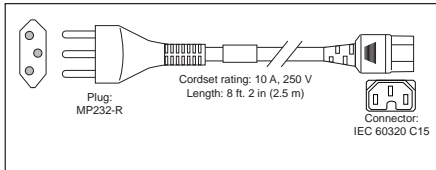
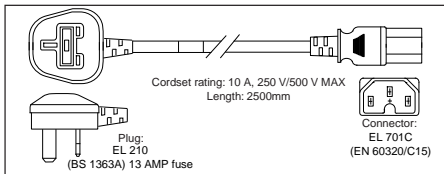
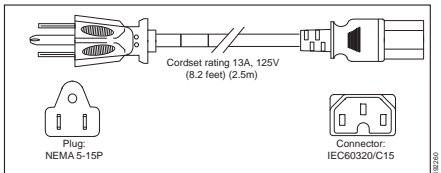
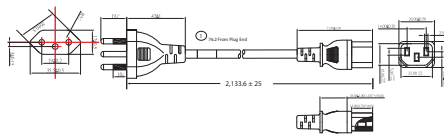

Table 12 Available Power Cords

Product ID (PID)	PID Description	Images
CAB-9K10A-IT	Power Cord, 250VAC 10A CEI 23-16/VII Plug, Italy	 <p>Plug: I/3G (CEI 23-16) Cordset rating: 10 A, 250 V Length: 8 ft 2 in (2.5 m) Connector: C15M (EN60320/C15)</p>
CAB-9K10A-SW	Power Cord, 250VAC 10A MP232 Plug, Switzerland	 <p>Plug: MP232-R Cordset rating: 10 A, 250 V Length: 8 ft 2 in (2.5 m) Connector: IEC 60320 C15</p>
CAB-9K10A-UK	Power Cord, 250VAC 10A BS1363 Plug (13 A fuse), UK	 <p>Cordset rating: 10 A, 250 V/500 V MAX Length: 2500mm Plug: EL 210 (BS 1363A) 13 AMP fuse Connector: EL 701 C (EN 60320/C15)</p>
CAB-9K12A-NA	Power Cord, 125VAC 13A NEMA 5-15 Plug, North America	 <p>Cordset rating: 13A, 125V (8.2 feet) (2.5m) Plug: NEMA 5-15P Connector: IEC60320/C15</p>
CAB-250V-10A-BR	Power Cord - 250V, 10A - Brazil	 <p>Cordset rating: 10 A, 250 V Length: 2,133.6 ± 25 mm</p>
CAB-JPN-3PIN	Power Cord 3PIN, Japan	Image not available

## STEP 9 ORDER POWER SUPPLY

The C22 M3 server accommodates one power supply. A lightly loaded server can operate from one 450 W power supply. A fully loaded server might need to be powered with a 650 W power supply (see [Table 13](#)).

Prior to making a power supply selection, the UCS Power Calculator should be run to determine the right size power supply for your server configuration. A fully configured C22 M3 server may require the 650 W power supply. The UCS Power Calculator can be found at the following link:

<http://ucspowercalc.cisco.com>

Table 13 Power Supply PIDs

Product ID (PID)	PID Description
UCSC-PSU-450W	450 W power supply
UCSC-PSU-650W	650 W power supply

## STEP 10 ORDER OPTIONAL REVERSIBLE CABLE MANAGEMENT ARM

The reversible cable management arm mounts on either the right or left slide rails at the rear of the server and is used for cable management. Use [Table 14](#) to order a cable management arm.

Table 14 Cable Management Arm

Product ID (PID)	PID Description
UCSC-CMA1	Cable Management Arm for C22 rack servers



**NOTE:** If you order and install a cable management arm, you will need the longest power cable available.

For more information about the cable management arm, see the *Cisco UCS C22 M3 Installation and Service Guide* at this URL:

[http://www.cisco.com/en/US/docs/unified\\_computing/ucs/c/hw/C22/install/C22.pdf](http://www.cisco.com/en/US/docs/unified_computing/ucs/c/hw/C22/install/C22.pdf)

## STEP 11 ORDER A TRUSTED PLATFORM MODULE

Trusted Platform Module (TPM) is a computer chip (microcontroller) that can securely store artifacts used to authenticate the platform (server). These artifacts can include passwords, certificates, or encryption keys. A TPM can also be used to store platform measurements that help ensure that the platform remains trustworthy. Authentication (ensuring that the platform can prove that it is what it claims to be) and attestation (a process helping to prove that a platform is trustworthy and has not been breached) are necessary steps to ensure safer computing in all environments.

The TPM ordering information is listed in [Table 15](#).

Table 15 Trusted Platform Module

Product ID (PID)	PID Description
UCSX-TPM1-001	Trusted Platform Module



**NOTE:** The module used in this server conforms to TPM v1.2/1.3, as defined by the Trusted Computing Group (TCG).

## STEP 12 ORDER OPTIONAL USB 2.0 DRIVE

You may order one optional USB 2.0 drive. One socket on the motherboard can accommodate an 8 or 16 GB drive.

The 8 or 16 GB drive (if ordered) is blank and comes installed on the motherboard. It can be used for a hypervisor or a license dongle.

The USB drive ordering information is listed in [Table 16](#).

Table 16 USB 2.0 Drive

Product ID (PID)	PID Description
UCS-USBFLSHA-8GB	8 GB Flash USB Drive for C22/C24
UCS-USBFLSHB-16GB	UCS Servers 16GB Flash USB Drive

See [Figure 6 on page 49](#) for the location of the internal USB connector.

## STEP 13 SELECT OPERATING SYSTEM AND VALUE-ADDED SOFTWARE

Several operating systems and value-added software programs are available. Select as desired from [Table 17](#).

Table 17 OSs and Value-Added Software (for 2-CPU servers)

PID Description	Product ID (PID)
<b>Cisco One</b>	
C1F2PUCSK9	Cisco ONE Foundation Perpetual UCS
C1F2SICFBK9	Cisco ONE Foundation Subsr Intercloud Fabric For Business
C1A1PUCSK9	Cisco ONE Enterprise Cloud Perpetual UCS
C1UCS-OPT-OUT	Cisco One Data Center Compute Opt Out Option
<b>Microsoft Windows Server</b>	
MSWS-12-ST2S	Windows Server 2012 Standard (2 CPU/2 VMs)
MSWS-12-DC2S	Windows Server 2012 Datacenter (2 CPU/Unlimited VMs)
MSWS-12-ST2S-NS	Windows Server 2012 Standard (2 CPU/2 VMs) No Cisco SVC
MSWS-12-DC2S-NS	Windows Server 2012 Datacenter (2 CPU/Unlim VM) No Cisco SVC
MSWS-12R2-ST2S	Windows Server 2012 R2 Standard (2 CPU/2 VMs)
MSWS-12R2-DC2S	Windows Server 2012 R2 Datacenter (2 CPU/Unlimited VMs)
MSWS-12R2-ST2S-NS	Windows Server 2012 R2 Standard (2 CPU/2 VMs) No Cisco SVC
MSWS-12R2-DC2S-NS	Windows Server 2012 R2 Datacen (2 CPU/Unlim VM) No Cisco Svc
<b>SUSE</b>	
SLES-2S2V-1A	SUSE Linux Enterprise Svr (1-2 CPU,1 Phys);1yr Support Reqd
SLES-2S2V-3A	SUSE Linux Enterprise Svr (1-2 CPU,1 Phys);3yr Support Reqd
SLES-2S2V-5A	SUSE Linux Enterprise Svr (1-2 CPU,1 Phys);5yr Support Reqd
SLES-2SUV-1A	SUSE Linux Enterprise Svr (1-2 CPU,Unl Vrt);1yr Support Reqd
SLES-2SUV-3A	SUSE Linux Enterprise Svr (1-2 CPU,Unl Vrt);3yr Support Reqd
SLES-2SUV-5A	SUSE Linux Enterprise Svr (1-2 CPU,Unl Vrt);5yr Support Reqd
SLES-2S-HA-1S	SUSE Linux High Availability Ext (1-2 CPU); 1yr Support Reqd
SLES-2S-HA-3A	SUSE Linux High Availability Ext (1-2 CPU); 3yr Support Reqd
SLES-2S-HA-5A	SUSE Linux High Availability Ext (1-2 CPU); 5yr Support Reqd
SLES-2S-GC-1S	SUSE Linux GEO Clustering for HA (1-2 CPU); 1yr Support Reqd
SLES-2S-GC-3S	SUSE Linux GEO Clustering for HA (1-2 CPU); 3yr Support Reqd
SLES-2S-GC-5S	SUSE Linux GEO Clustering for HA (1-2 CPU); 5yr Support Reqd
SLES-SAP-2S2V-1A	SLES for SAP Applications (1-2 CPU,1 Phys); 1yr Support Reqd
SLES-SAP-2S2V-3A	SLES for SAP Applications (1-2 CPU,1 Phys); 3yr Support Reqd
SLES-SAP-2S2V-5A	SLES for SAP Applications (1-2 CPU,1 Phys); 5yr Support Reqd
SLES-SAP-2SUV-1A	SLES for SAP Applications (1-2 CPU,Unl Vrt);1yr Support Reqd
SLES-SAP-2SUV-3A	SLES for SAP Applications (1-2 CPU,Unl Vrt);3yr Support Reqd
SLES-SAP-2SUV-5A	SLES for SAP Applications (1-2 CPU,Unl Vrt);5yr Support Reqd
<b>Nexus 1000V for Hyper-V and vSphere</b>	

Table 17 OSs and Value-Added Software (for 2-CPU servers) (continued)

PID Description	Product ID (PID)
N1K-VSG-UCS-BUN	Over half off N1K and VSG w/ purchase of UCS B/C Series
N1K-VLEM-UCS-1	Nexus 1000V License Paper Delivery (1 CPU) for bundles
VSG-VLEM-UCS-1	VSG License Paper Delivery (1 CPU) for bundles
<b>UCS Director</b>	
CUIC-PHY-SERV-BM-U	Cisco Cloupia Resource Lic - One Phy Server node bare metal
CUIC-PHY-SERV-U	Cisco Cloupia Resource Lic - One physical Server node
CUIC-TERM	Acceptance of Cisco Cloupia License Terms
<b>UCS Performance Manager</b>	
UCS-PM-IE	UCS Performance Manager
UCS-PM-EE	UCS Performance Manager Express
EVAL-UCS-PM-IE	UCS Performance Manager - 60 days evaluation
EVAL-UCS-PM-EE	UCS Performance Manager Express - 60 days evaluation
NFR-UCS-PM-IE	UCS Performance Manager - Not For Resale
NFR-UCS-PM-EE	CS Performance Manager Express - Not For Resale
<b>IMC Supervisor</b>	
EVAL-CIMC-SUP	EVAL: IMC Supervisor-Branch Mgt SW for C/E-Series - 50 Svrs
EVAL-CIMC-SUP-BAS	EVAL: IMC Supervisor One-time Site Installation License
CIMC-SUP-B01	IMC Supervisor-Branch Mgt SW for C-Series & E-Series up to 100 Svrs
CIMC-SUP-B02	IMC Supervisor- Branch Mgt SW for C-Series & E-Series up to 250 Svrs
CIMC-SUP-B10	IMC Supervisor- Branch Mgt SW for C-Series & E-Series up to 1K Svrs
CIMC-SUP-BASE-K9	IMC Supervisor One-time Site Installation License
CIMC-SUP-TERM	Acceptance of Cisco IMC Supervisor License Terms
<b>VMware 5</b>	
VMW-VS5-STD-1A	VMware vSphere 5 Standard for 1 Processor, 1 Year, Support Rqd
VMW-VS5-STD-2A	VMware vSphere 5 Standard for 1 Processor, 2 Year, Support Rqd
VMW-VS5-STD-3A	VMware vSphere 5 Standard for 1 Processor, 3 Year, Support Rqd
VMW-VS5-STD-4A	VMware vSphere 5 Standard for 1 Processor, 4 Year, Support Rqd
VMW-VS5-STD-5A	VMware vSphere 5 Standard for 1 Processor, 5 Year, Support Rqd
VMW-VS5-ENT-1A	VMware vSphere 5 Enterprise for 1 Processor, 1 Year Support Rqd
VMW-VS5-ENT-2A	VMware vSphere 5 Enterprise for 1 CPU, 2 Yr Support Rqd
VMW-VS5-ENT-3A	VMware vSphere 5 Enterprise for 1 CPU, 3 Yr Support Rqd
VMW-VS5-ENT-4A	VMware vSphere 5 Enterprise for 1 Processor, 4 Year Support Rqd
VMW-VS5-ENT-5A	VMware vSphere 5 Enterprise for 1 CPU, 5 Yr Support Rqd
VMW-VS5-ENTP-1A	VMware vSphere 5 Enterprise Plus for 1 Processor, 1 Year Support Rqd
VMW-VS5-ENTP-2A	VMware vSphere 5 Enterprise Plus for 1 CPU, 2 Yr Support Rqd
VMW-VS5-ENTP-3A	VMware vSphere 5 Enterprise Plus for 1 Processor, 3 Year Support Rqd
VMW-VS5-ENTP-4A	VMware vSphere 5 Enterprise Plus for 1 Processor, 4 Year Support Rqd
VMW-VC5-STD-1A	VMware vCenter 5 Server Standard, 1 yr support required
VMW-VC5-STD-2A	VMware vCenter 5 Server Standard, 2 yr support required

Table 17 OSs and Value-Added Software (for 2-CPU servers) *(continued)*

PID Description	Product ID (PID)
VMW-VC5-STD-3A	VMware vCenter 5 Server Standard, 3 yr support required
VMW-VC5-STD-4A	VMware vCenter 5 Server Standard, 4 yr support required
VMW-VC5-STD-5A	VMware vCenter 5 Server Standard, 5 yr support required



## STEP 14 SELECT OPERATING SYSTEM MEDIA KIT

Select the optional operating system media listed in [Table 18](#).

Table 18 OS Media

Product ID (PID)	PID Description
RHEL-6	RHEL 6 Recovery Media Only (Multilingual)
SLES-11	SLES 11 media only (multilingual)
MSWS-08R2-STHV-RM	Windows Svr 2008 R2 ST (1-4CPU, 5CAL), Media
MSWS-08R2-ENHV-RM	Windows Svr 2008 R2 EN (1-8CPU, 25CAL), Media
MSWS-08R2-DCHV-RM	Windows Svr 2008 R2 DC (1-8CPU, 25CAL), Media
MSWS-12-ST2S-RM	Windows Server 2012 Standard (2 CPU/2 VMs) Recovery Media
MSWS-12-DC2S-RM	Windows Server 2012 Datacenter (2 CPU/Unlimited VM) Rec Media
MSWS-12R2-ST2S-RM	Windows Server 2012 R2 Standard (2 CPU/2 VMs) Recovery Media
MSWS-12R2-DC2S-RM	Windows Server 2012 R2 Datacen(2 CPU/Unlimited VM) Rec Media

## STEP 15 SELECT SERVICE and SUPPORT LEVEL

A variety of service options are available, as described in this section.

### Unified Computing Warranty, No Contract

If you have noncritical implementations and choose to have no service contract, the following coverage is supplied:

- Three-year parts coverage.
- Next business day (NBD) onsite parts replacement eight hours a day, five days a week.
- 90-day software warranty on media.
- Ongoing downloads of BIOS, drivers, and firmware updates.
- UCSM updates for systems with Unified Computing System Manager. These updates include minor enhancements and bug fixes that are designed to maintain the compliance of UCSM with published specifications, release notes, and industry standards.

### SMARTnet for UCS

For support of the entire Unified Computing System, Cisco offers the Cisco SMARTnet for UCS Service. This service provides expert software and hardware support to help sustain performance and high availability of the unified computing environment. Access to Cisco Technical Assistance Center (TAC) is provided around the clock, from anywhere in the world.

For UCS blade servers, there is Smart Call Home, which provides proactive, embedded diagnostics and real-time alerts. For systems that include Unified Computing System Manager, the support service includes downloads of UCSM upgrades. The Cisco SMARTnet for UCS Service includes flexible hardware replacement options, including replacement in as little as two hours. There is also access to Cisco's extensive online technical resources to help maintain optimal efficiency and uptime of the unified computing environment. You can choose a desired service listed in [Table 19](#).

Table 19 Cisco SMARTnet for UCS Service

Product ID (PID)	On Site?	Description
CON-PREM-C22M3S	Yes	ONSITE 24X7X2 UCS C22 M3 Server - SFF
CON-OSP-C22M3S	Yes	ONSITE 24X7X4 UCS C22 M3 Server - SFF
CON-OSE-C22M3S	Yes	ONSITE 8X5X4 UCS C22 M3 Server - SFF
CON-OS-C22M3S	Yes	ONSITE 8X5XNBD UCS C22 M3 Server - SFF
CON-S2P-C22M3S	No	SMARTNET 24X7X2 UCS C22 M3 Server - SFF
CON-SNTP-C22M3S	No	SMARTNET 24X7X4 UCS C22 M3 Server - SFF
CON-SNTE-C22M3S	No	SMARTNET 8X5X4 UCS C22 M3 Server - SFF
CON-SNT-C22M3S	No	SMARTNET 8X5XNBD UCS C22 M3 Server - SFF

### SMARTnet for UCS Hardware Only Service

For faster parts replacement than is provided with the standard Cisco Unified Computing System warranty, Cisco offers the Cisco SMARTnet for UCS Hardware Only Service. You can choose from two levels of advanced onsite parts replacement coverage in as little as four hours. SMARTnet for UCS Hardware Only Service provides remote access any time to Cisco support professionals who can determine if a return materials authorization (RMA) is required. You can choose a service listed in [Table 20](#).

Table 20 SMARTnet for UCS Hardware Only Service

Product ID (PID)	Service Level GSP	On Site?	Description
CON-UCW7-C22M3S	UCW7	Yes	UC PLUS 24X7X40S UCS C22 M3 Server - SFF
CON-UCW5-C22M3S	UCW5	Yes	UC PLUS 8X5XNBDOS UCS C22 M3 Server - SFF

### Unified Computing Partner Support Service

Cisco Partner Support Service (PSS) is a Cisco Collaborative Services service offering that is designed for partners to deliver their own branded support and managed services to enterprise customers. Cisco PSS provides partners with access to Cisco's support infrastructure and assets to help them:

- Expand their service portfolios to support the most complex network environments
- Lower delivery costs
- Deliver services that increase customer loyalty

Partner Unified Computing Support Options enable eligible Cisco partners to develop and consistently deliver high-value technical support that capitalizes on Cisco intellectual assets. This helps partners to realize higher margins and expand their practice.

PSS is available to all Cisco PSS partners, but requires additional specializations and requirements. For additional information, see the following URL:

[www.cisco.com/go/partnerucssupport](http://www.cisco.com/go/partnerucssupport)

The two Partner Unified Computing Support Options include:

- Partner Support Service for UCS
- Partner Support Service for UCS Hardware Only

Partner Support Service for UCS provides hardware and software support, including triage support for third party software, backed by Cisco technical resources and level three support.

See [Table 21](#).

Table 21 Partner Support Service for UCS

Product ID (PID)	Service Level GSP	On Site?	Description
CON-PSJ1-C22M3S	PSJ1	No	UCS SUPP PSS 8X5XNBD UCS C22 M3 Server - SFF
CON-PSJ2-C22M3S	PSJ2	No	UCS SUPP PSS 8X5X4 UCS C22 M3 Server - SFF
CON-PSJ3-C22M3S	PSJ3	No	UCS SUPP PSS 24X7X4 UCS C22 M3 Server - SFF
CON-PSJ4-C22M3S	PSJ4	No	UCS SUPP PSS 24X7X2 UCS C22 M3 Server - SFF

Partner Support Service for UCS Hardware Only provides customers with replacement parts in as little as two hours. See [Table 22](#).

Table 22 Partner Support Service for UCS (Hardware Only)

Product ID (PID)	Service Level GSP	On Site?	Description
CON-PSW2-C22M3S	PSW2	No	UCS W PL PSS 8X5X4 UCS C22 M3 Server - SFF
CON-PSW3-C22M3S	PSW3	No	UCS W PL PSS 24X7X4 UCS C22 M3 Server - SFF
CON-PSW4-C22M3S	PSW4	No	UCS W PL PSS 24X7X2 UCS C22 M3 Server - SFF

### Unified Computing Combined Support Service

Combined Services makes it easier to purchase and manage required services under one contract. SMARTnet services for UCS help increase the availability of your vital data center infrastructure and realize the most value from your unified computing investment. The more benefits you realize from the Cisco Unified Computing System (Cisco UCS), the more important the technology becomes to your business. These services allow you to:

- Optimize the uptime, performance, and efficiency of your UCS
- Protect your vital business applications by rapidly identifying and addressing issues
- Strengthen in-house expertise through knowledge transfer and mentoring
- Improve operational efficiency by allowing UCS experts to augment your internal staff resources
- Enhance business agility by diagnosing potential issues before they affect your operations

You can choose a service listed in [Table 23](#).

Table 23 UCS Computing Combined Support Service

Product ID (PID)	Service Level GSP	On Site?	Description
CON-NCF2-C22M3S	NCF2	No	CMB SPT SVC 24X7X2 UCS C22 M3 Server - SFF
CON-NCF2P-C22M3S	NCF2P	Yes	CMB SPT SVC 24X7X2OS UCS C22 M3 Server - SFF
CON-NCF4P-C22M3S	NCF4P	Yes	CMB SPT SVC 24X7X4OS UCS C22 M3 Server - SFF
CON-NCF4S-C22M3S	NCF4S	Yes	CMB SPT SVC 8X5X4OS UCS C22 M3 Server - SFF
CON-NCFCS-C22M3S	NCFCS	Yes	CMB SPT SVC 8X5XNBDOS UCS C22 M3 Server - SFF
CON-NCFE-C22M3S	NCFE	No	CMB SPT SVC 8X5X4 UCS C22 M3 Server - SFF
CON-NCFP-C22M3S	NCFP	No	CMB SPT SVC 24X7X4 UCS C22 M3 Server - SFF
CON-NCFT-C22M3S	NCFT	No	CMB SPT SVC 8X5XNBD UCS C22 M3 Server - SFF

#### Unified Computing Drive Retention Service

With the Cisco Unified Computing Drive Retention (UCDR) Service, you can obtain a new disk drive in exchange for a faulty drive without returning the faulty drive. In exchange for a Cisco replacement drive, you provide a signed Certificate of Destruction (CoD) confirming that the drive has been removed from the system listed, is no longer in service, and has been destroyed.

Sophisticated data recovery techniques have made classified, proprietary, and confidential information vulnerable, even on malfunctioning disk drives. The UCDR service enables you to retain your drives and ensures that the sensitive data on those drives is not compromised, which reduces the risk of any potential liabilities. This service also enables you to comply with regulatory, local, and federal requirements.

If your company has a need to control confidential, classified, sensitive, or proprietary data, you might want to consider one of the Drive Retention Services listed in [Table 24](#).



**NOTE:** Cisco does not offer a certified drive destruction service as part of this service.

Table 24 Drive Retention Service Options

Service Description	Service Program Name	Service Level GSP	Service Level	Product ID (PID)
SMARTnet for UCS Service with Drive Retention	UCS DR	UCSD7	24x7x4 Onsite	CON-UCSD7-C22M3S
		UCSD7	8x5xNBD Onsite	CON-UCSD5-C22M3S

Table 24 Drive Retention Service Options (*continued*)

Service Description	Service Program Name	Service Level GSP	Service Level	Product ID (PID)
SMARTnet for UCS HW ONLY+Drive Retention	UCS HW+DR	UCWD7	24x7x4 Onsite	CON-UCWD7-C22M3S
		UCWD5	8x5xNBD Onsite	CON-UCWD5-C22M3S

For more service and support information, see the following URL:

[http://www.cisco.com/en/US/services/ps2961/ps10312/Unified\\_Computing\\_Services\\_Overview.pdf](http://www.cisco.com/en/US/services/ps2961/ps10312/Unified_Computing_Services_Overview.pdf)

For a complete listing of available services for Cisco Unified Computing System, see this URL:

[http://www.cisco.com/en/US/products/ps10312/serv\\_group\\_home.html](http://www.cisco.com/en/US/products/ps10312/serv_group_home.html)

## OPTIONAL STEP - ORDER RACK(s)

The optional R42610 rack is available from Cisco for the C-Series servers, including the C22 M3 SFF server. This rack is a standard 19-inch rack and can be ordered with a variety of options, as listed in [Table 25](#). Racks are shipped separately from the C22 M3 SFF server.

Table 25 Racks and Rack Options

Product ID (PID)	PID Description
RACK-UCS <sup>1</sup>	Cisco R42610 expansion rack, no side panels
RACK-UCS2 <sup>1</sup>	Cisco R42610 standard rack, w/side panels
RACK-BLANK-001	Filler panels (qty 12), 1U, plastic, toolless
RACK-CBLMGT-001	Cable mgt D rings (qty 10), metal
RACK-CBLMGT-011	Cable mgt straps (qty 10), Velcro
RACK-FASTEN-001	Mounting screws (qty 100), M6
RACK-FASTEN-002	Cage nuts (qty 50), M6
RACK-JOIN-001	Rack joining kit

Notes . . .

1. Use these same base PIDs to order spare racks (available only as next-day replacements).

For more information about the R42610 rack, see [RACKS, page 58](#).

## OPTIONAL STEP - ORDER PDU

An optional power distribution unit (PDU) is available from Cisco for the C-Series rack servers, including the C22 M3 server. This PDU is available in a zero rack unit (RU) style (see [Table 25](#)).

Table 26 PDU Options

Product ID (PID)	PID Description
RP208-30-2P-U-2	Zero RU PDU

For more information about the PDU, see [PDUs, page 60](#).



# SUPPLEMENTAL MATERIAL

## CHASSIS

An internal view of the C22 M3 chassis with the top cover removed is shown in *Figure 6*.

Figure 6 C22 M3 SFF With Top Cover Off

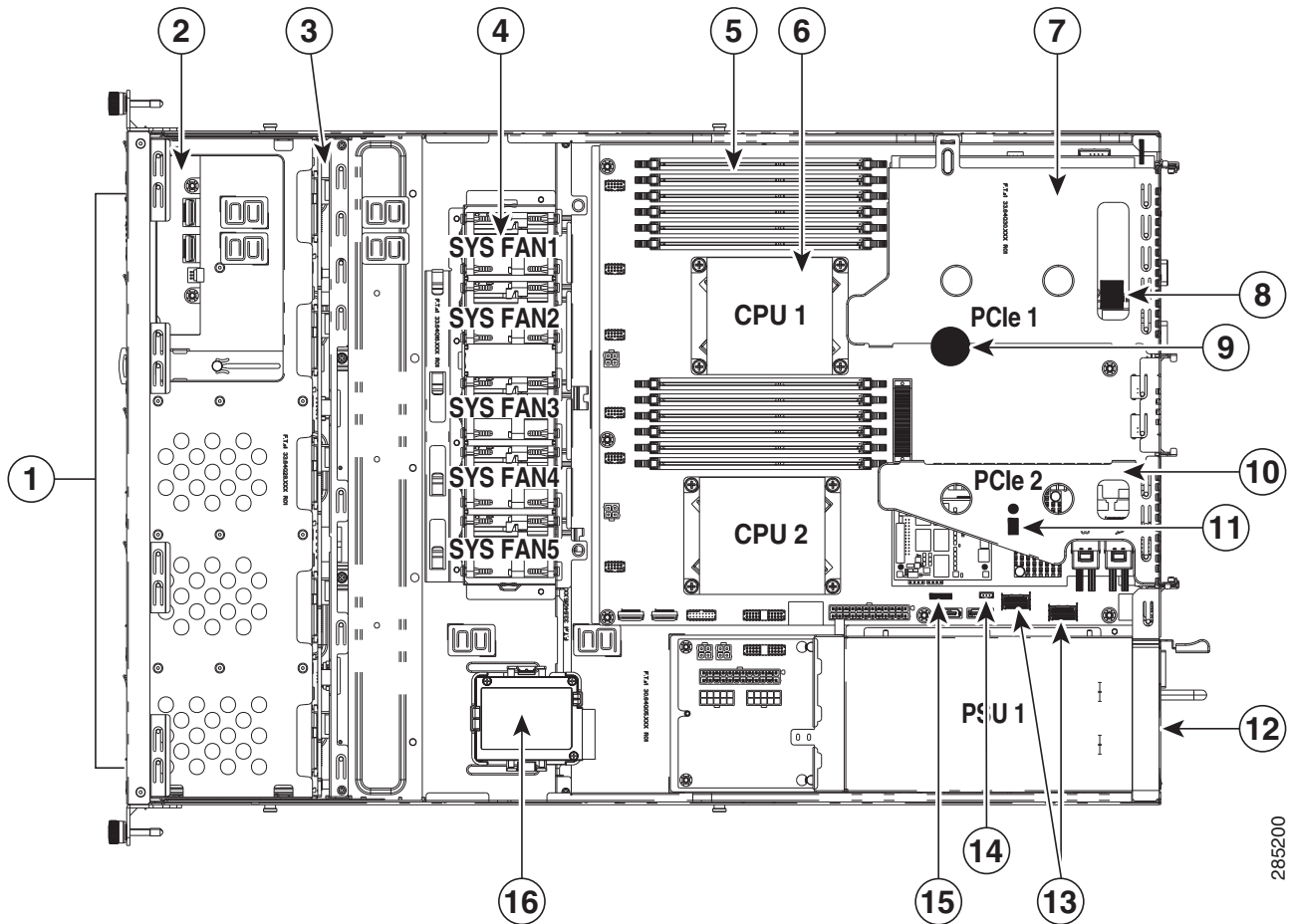

285200

1	Drives (hot-swappable, accessed through front panel)	9	RTC battery on motherboard
2	Front panel operations board	10	PCIe riser 2 (PCIe slot 2)
3	Drive backplane	11	Trusted platform module socket on motherboard (not visible under PCIe riser 2)
4	Cooling fans (five)	12	Power supply (accessed through rear panel)

5	DIMM slots on motherboard (12)	13	Integrated SAS RAID connectors on motherboard (left to right, SCU_Port 0, SCU_Port 1)
6	CPU and heatsinks (2)	14	Software RAID 5 key header on motherboard
7	PCIe riser 1 (PCIe slot 1)	15	RAID SCU option ROM header on motherboard
8	Internal USB 2.0 port (on motherboard under PCIe riser 1)	16	Mounting point for SuperCap power module (RAID backup unit)

## CPUs and DIMMs

### Physical Layout

Each CPU has three DIMM channels:

- CPU1 has channels A, B, and C
- CPU2 has channels D, E, and F

Each DIMM channel has two banks: Bank 1 and Bank 2. The blue-colored DIMM banks are for Bank 1 and the black-colored are for Bank 2.

As an example, DIMM slots A1, B1, and C1 belong to Bank 1, while A2, B2, and C2 belong to Bank 2.

*Figure 7* shows how banks and channels are physically laid out on the motherboard. The DIMM slots on the top (channels A, B, and C) are associated with CPU 1, while the DIMM slots on the bottom (channels D, E, and F) are associated with CPU 2. Bank 1 slots (blue) are populated before Bank 2 slots (black).

Figure 7 Physical Layout of CPU DIMM Channels and Banks

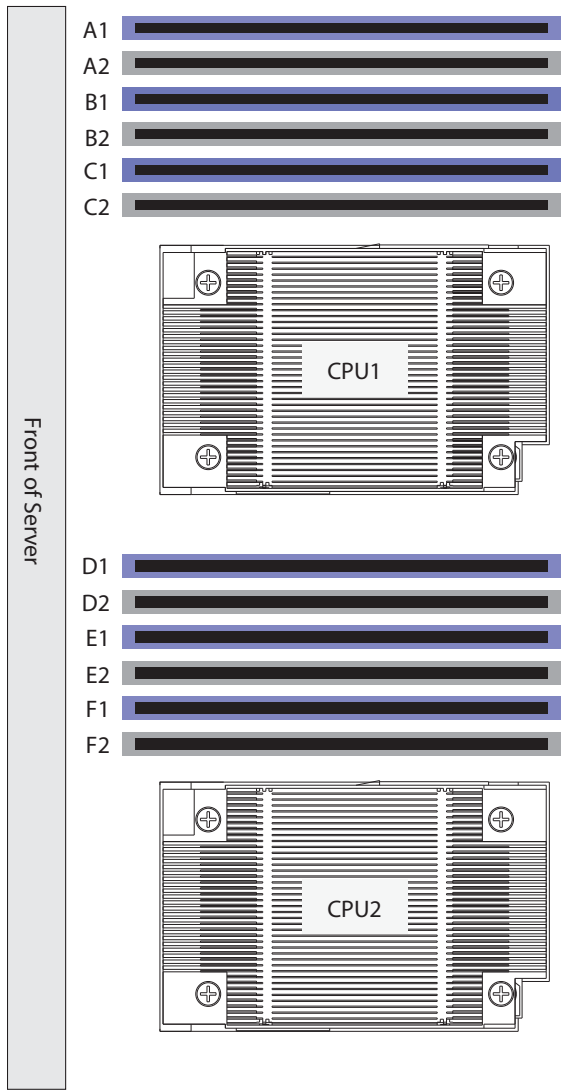

## Memory Population Rules

When considering the memory configuration of your server, you should consider the following items:

- Each channel has two DIMM slots (for example, channel A = slots A1 and A2).
  - Each channel can operate with one or two DIMMs installed.
  - If a channel has only one DIMM, populate slot 1 first (the blue slot).
- When both CPUs are installed, populate the DIMM slots of each CPU identically.
  - Fill blue slots in the channels first: A1, D1, B1, E1, C1, F1
  - Fill black slots in the channels second: A2, D2, B2, E2, C2, F2
- Any DIMM installed in a DIMM socket for which the CPU is absent is not recognized.
- For optimum performance, populate at least one DIMM per memory channel per CPU.
- When populating DIMM slots, multiples of 6 DIMMs are best for achieving optimum performance, since there are 3 memory channels per CPU socket and 2 CPUs must be populated.
- At 1 DPC and 2 DPC, 1600-MHz DIMMs will run at 1600 MHz (provided the CPU supports 1600 MHz DIMMs) and 1333-MHz DIMMs will run at 1333 MHz.
- When mixing DIMMs, the following rules need to be followed:
  - When mixing DIMMs of different densities (sizes), populate DIMMs with the highest density first. For example, if you have to mix 16 GB with 8 GB DIMMs, populate 16 GB DIMMs in blue slots (or bank 1) and then 8 GB in black slots (or bank 2).
  - When mixing DIMMs with different ranks, populate DIMMs with the higher rank first. For example, populate 16 GB 2R or 8 GB 2R before 4 GB 1R DIMMs.
  - DIMMs of different sizes (4 GB, 8 GB, 16 GB) can be mixed within a channel. Total memory size in each single channel should be the same. For example, if you are mixing 4 GB and 8 GB DIMMs to achieve total 72 GB (6x8 GB + 6x4 GB) for a server, then populate blue slots with 8 GB DIMMs and black slots with 4 GB DIMMs and total memory size should be 12 GB for each of the 3 channels for both CPUs.
  - When mixing DIMMs, all the DIMMs in the server must be the same speed.

## Recommended Memory Population

This section explains the recommended DIMM population order rules for the C22 M3 server.

- All DIMMs must be DDR3 DIMMs.
- Mixing of Registered and Unbuffered DIMMs is not allowed per platform.
- Do not mix 1333-MHz DIMMs with 1600-MHz DIMMs.

Follow [Table 27](#) when populating DIMMs in the server.



**NOTE:** This table lists only some recommended and suggested configurations. There are numerous other possible configurations supported by Cisco. Cisco supports all mixing and population configurations of the Cisco DIMMs as long as the mixing does not violate the few fundamental rules noted in this document.

Table 27 Recommended DIMM Population

Total Memory Size	CPU 1		CPU 2		Total DIMMs in System
	Blue Slots Bank 1 (A1, B1, C1)	Black Slots Bank 2 (A2, B2, C2)	Blue Slots Bank 1 (D1, E1, F1)	Black Slots Bank 2 (D2, E2, F2)	
48 GB <sup>1</sup>	3 x 4 GB	3 x 4 GB	3 x 4 GB	3 x 4 GB	12
	3 x 8 GB	—	3 x 8 GB	—	6
72 GB	3 x 8 GB	3 x 4 GB	3 x 8 GB	3 x 4 GB	12
96 GB <sup>2</sup>	3 x 8 GB	3 x 8 GB	3 x 8 GB	3 x 8 GB	12
	3 x 16 GB	—	3 x 16 GB	—	6
120 GB	3 x 16 GB	3 x 4 GB	3 x 16 GB	3 x 4 GB	12
144 GB	3 x 16 GB	3 x 8 GB	3 x 16 GB	3 x 8 GB	12
192 GB	3 x 16 GB	3 x 16 GB	3 x 16 GB	3 x 16 GB	12
384 GB	3 x 32 GB	3 x 32 GB	3 x 32 GB	3 x 32 GB	12

Notes . . .

1. For 48 GB, there are two possible sweet spot configurations:

6 x 8 GB occupies 1 DPC, so there is a possibility of increasing total memory size in the system (beyond 48 GB) by going to 2 DPC while still maintaining memory speed at 1600 MHz.

If there is no plan to increase total memory size in the system (beyond 48 GB), then 12 x 4GB is more price effective at this time.

2. For 96 GB, there are two possible optimal configurations:

6 x 16GB occupies 1 DPC, so there is a possibility of increasing total memory size in the system (beyond 96 GB) by going to 2 DPC while maintaining the maximum memory speed at 1600 MHz.

12 x 8GB gives the peak performance for this configuration and is recommended if there is no plan of increasing the total memory in the future.

## Additional DIMM Populations

The list in [Table 28](#) is not a complete list of all supported DIMM populations, but highlights common configuration options.

Table 28 Supported DIMM Configurations

CPU 1 DIMMs	# CPU 1 DIMMs	CPU 1 Capacity	CPU 2 DIMMs	# CPU 2 DIMMs	CPU 2 Capacity	Total DIMMs for both CPUs	Total Capacity for 2 CPUs
1 x 4 GB	1	4 GB	1 x 4 GB	1	4 GB	2	8 GB
2 x 4 GB	2	8 GB	2 x 4 GB	2	8 GB	4	16 GB
1 x 8 GB	1	8 GB	1 x 8 GB	1	8 GB	2	16 GB
3 x 4 GB	3	12 GB	3 x 4 GB	3	12 GB	6	24 GB
4 x 4 GB	4	16 GB	4 x 4 GB	4	16 GB	8	32 GB
2 x 8 GB	2	16 GB	2 x 8 GB	2	16 GB	4	32 GB
1 x 16 GB	1	16 GB	1 x 16 GB	1	16 GB	2	32 GB
5 x 4 GB	5	20 GB	5 x 4 GB	5	20 GB	10	40 GB
6 x 4 GB	6	24GB	6 x 4 GB	6	24GB	12	48 GB
3 x 8 GB	3	24 GB	3 x 8 GB	3	24 GB	6	48 GB
4 x 8 GB	4	32 GB	4 x 8 GB	4	32 GB	8	64 GB
2 x 16 GB	2	32 GB	2 x 16 GB	2	32 GB	4	64 GB
3 x 8 GB + 3 x 4 GB <sup>1</sup>	6	36 GB	3 x 8 GB + 3 x 4 GB <sup>2</sup>	6	36 GB	12	72 GB
5 x 8 GB	5	40 GB	5 x 8 GB	5	40 GB	10	80 GB
6 x 8 GB	6	48 GB	6 x 8 GB	6	48 GB	12	96 GB
3 x 16 GB	3	48 GB	3 x 16 GB	3	48 GB	6	96 GB
3 x 16 GB + 3 x 4 GB <sup>3</sup>	6	60 GB	3 x 16 GB + 3 x 4 GB <sup>4</sup>	6	60 GB	12	120 GB
4 x 16 GB	4	64 GB	4 x 16 GB	4	64 GB	8	128 GB
3 x 8 GB + 3 x 16 GB <sup>5</sup>	6	72 GB	3 x 8 GB + 3 x 16 GB <sup>6</sup>	6	72 GB	12	144 GB
5 x 16 GB	5	80 GB	5 x 16 GB	5	80 GB	10	160 GB
6 x 16 GB	6	96 GB	6 x 16 GB	6	96 GB	12	192 GB
6 x 32 GB	6	192 GB	6 x 32 GB	6	192 GB	12	384 GB

Notes . . .

1. UCS-MR-1X082RY-A + UCS-MR-1X041RY-A
2. UCS-MR-1X082RY-A + UCS-MR-1X041RY-A
3. UCS-MR-1X162RY-A + UCS-MR-1X041RY-A
4. UCS-MR-1X162RY-A + UCS-MR-1X041RY-A
5. UCS-MR-1X082RY-A + UCS-MR-1X162RY-A
6. UCS-MR-1X082RY-A + UCS-MR-1X162RY-A

## Low-Voltage DIMM Considerations

The C22 M3 server can be ordered with low-voltage (1.35 V) DIMMs only. Note the following considerations:

- Low-voltage DIMMs within the server must have the identical manufacturer, type, speed, and size.
- Low-voltage DIMMs and standard-voltage DIMMs can be mixed in the same server. Note that this causes the system BIOS to default to standard-voltage operation (Performance Mode). That is, the server cannot operate in Power Saving Mode unless all DIMMs are low-voltage DIMMs.
- CPUs that have a maximum memory frequency less than 1333 MHz support low-voltage DIMMs operating in Power Saving Mode only, and do not support Performance Mode.

## RAID Summary

- ROM5 and ROM55 embedded RAID upgrade options each support up to 8 drives.
- The LSI MegaRAID SAS 9270CV-8i, 9240-8i, and 9220-8i RAID controller cards each support up to 8 drives



**NOTE:** If you *do not* select a PCIe RAID controller or one of the embedded RAID upgrade options (ROM5 or ROM55), you will have an embedded SATA-only RAID controller that supports up to four SATA-only drives (RAID 0, 1, 10).

See [Table 29](#) for a summary of the supported RAID configuration options.

Table 29 Supported RAID Configurations

Server	# CPUs	Embedded RAID	Internal PCIe RAID #1 <sup>1</sup>	Internal PCIe RAID #2	# Drives Supported	PCIe Slots <sup>2</sup>	
						1	2
C22 M3 SFF	1	Not allowed	Installed slot 1 (default) <sup>3</sup>	Not allowed	8 internal	O	U
	1	Enabled	Not allowed	Not allowed	8 internal	A	U
C22 M3 SFF	2	Not allowed	Installed slot 2 (default)	Not allowed	8 internal	A	O
	2	Enabled	Not allowed	Not allowed	8 internal	A	A

Notes . . .

1. If you want to boot from a device other than the 9270CV-8i, 9240-8i, or 9220-8i MegaRAID PCIe cards, you can leave the cards installed. Just disable the OPROM for their slots, and the system will boot even with the cards installed.
2. A = available slot, O = occupied slot, U = unsupported slot (slot 2 is not supported in 1-CPU systems)
3. The OPROM is enabled for the default PCIe RAID controller slots. If you want to enable a different slot, you must go into the BIOS and enable the OPROM for the desired slot and disable the OPROM for the default PCIe slot (see [Figure 8 on page 57](#)).



## RAID Option ROM (OPROM) Settings

The server contains an Option ROM (OPROM) for the PCIe slots. The server has a finite amount of option ROM with which it can boot up devices. Go into the BIOS and disable the OPROM on the PCIe slots not used for booting so that resources are available for the slots that are used for booting. An example OPROM BIOS screen is shown in [Figure 8](#).

Figure 8 Example BIOS Screen for OPROM

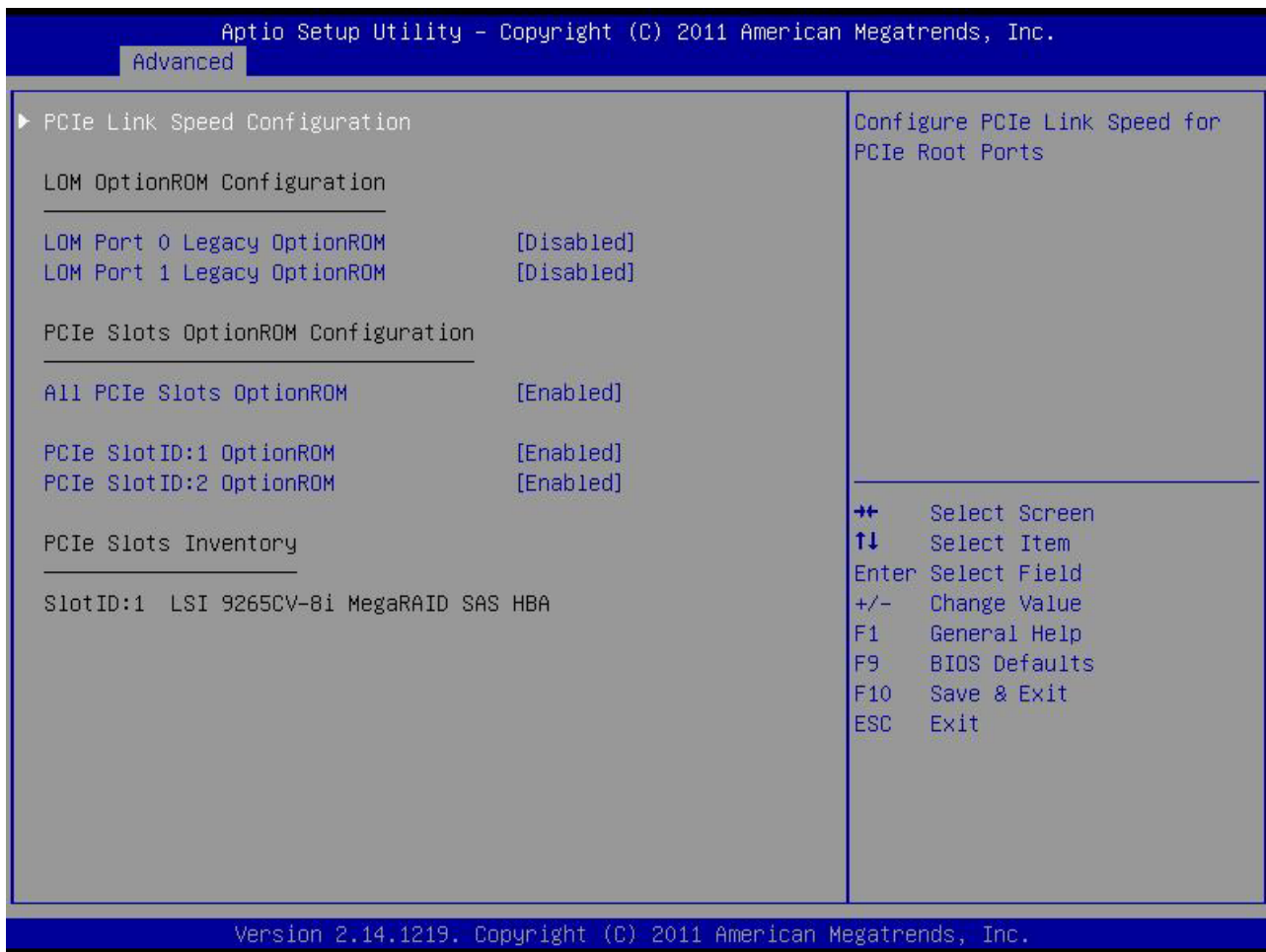

## RACKS

The Cisco R42610 rack (see [Figure 9](#)) is certified for Cisco UCS installation at customer sites and is suitable for the following equipment:

- Cisco UCS B-Series servers and fabric interconnects
- Cisco UCS C-Series and select Nexus switches

The rack is compatible with hardware designed for EIA-standard 19-inch racks. Rack specifications are listed in [Table 30](#).

Table 30 Cisco R42610 Rack Specifications

Parameter	Standard Rack	Expansion Rack
Dimensions (H x W x D)	78.74 x 24 x 43.38 in. (2000 x 610 x 1102 mm)	78.74 x 23.58 x 43.38 in. (2000 x 599 x 1102 mm)
Dimensions (H x W x D) with packaging	89 x 33 x 47 in. (2261 x 838 x 1194 mm)	89 x 33 x 47 in. (2261 x 838 x 1194 mm)
Distance from front mounting rail to rear mounting rail	29.2 in (741 mm)	29.2 in (741 mm)
Weight	299.83 lb (136 kg)	231.49 lb (105 kg)
Weight with packaging	354 lb (161 kg)	284 lb (129 kg)
Side panels included	Yes	No
Equipment mounting capacity	42RU	42RU
Static load capacity	2100 lb (954 kg)	2100 lb (954 kg)
Dynamic load capacity	Not applicable	Not applicable



NOTE: The AC input connector is an IEC 320 C-14 15 A/250 VAC power inlet.

Figure 9 Cisco R42610 Rack



Front view - door closed



Front view - door open



Front view - door removed

## PDUs

Cisco RP Series Power Distribution Units (PDUs) offer power distribution with branch circuit protection.

Cisco RP Series PDU models distribute power to up to 24 outlets. The architecture organizes power distribution, simplifies cable management, and enables you to move, add, and change rack equipment without an electrician.

With a Cisco RP Series PDU in the rack, you can replace up to two dozen input power cords with just one. The fixed input cord connects to the power source from overhead or under-floor distribution. Your IT equipment is then powered by PDU outlets in the rack using short, easy-to-manage power cords.

The C-series severs accept the zero-rack-unit (ORU) PDU. See [Figure 10](#).

Figure 10 Zero Rack Unit PDU (PID = RP208-30-2P-U-2)

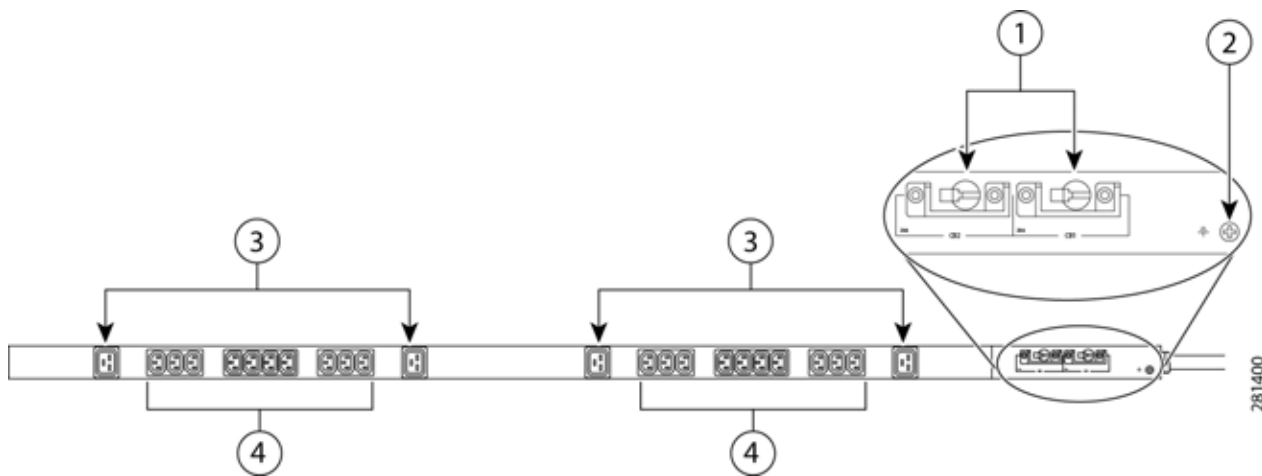

1	Breakers	3	C13 plugs
2	Ground connection	4	C19 plugs

Cisco RP Series PDU models provide two 20-ampere (A) circuit breakers for groups of receptacles. The effects of a tripped circuit are limited to a receptacle group. Simply press a button to reset that circuit.

## Motherboard USB Port

The C22 M3 SFF motherboard has one general-purpose USB socket as shown in *Figure 11*.

Figure 11 Motherboard USB Port

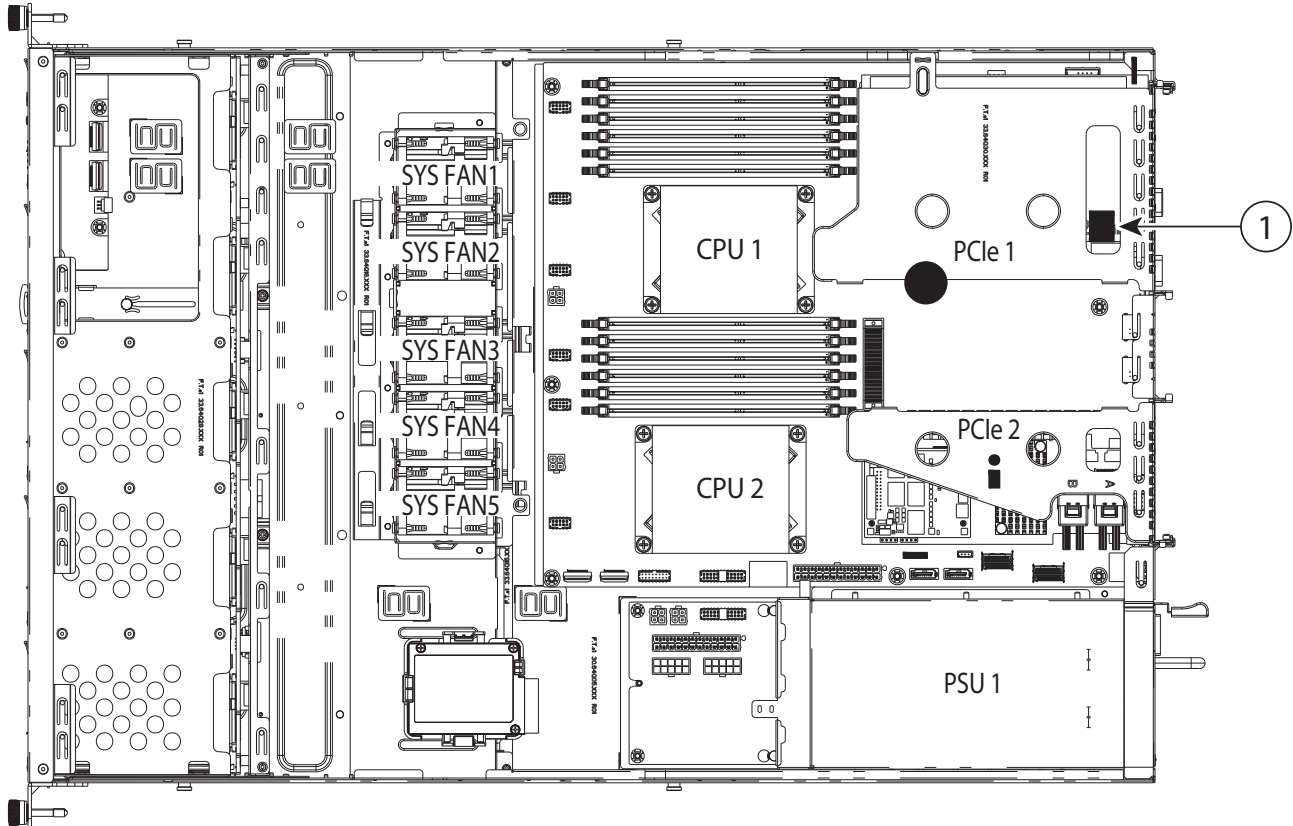

1	Internal USB 2.0 port (on motherboard under PCIe riser 1)	-	-
---	--	---	---

## LED Indicators

The server contains LED indicators on the front and rear panels. Their functions are described in the following sections.

### Front Panel

Figure 12 shows the front panel LEDs.

Figure 12 Front Panel LEDs

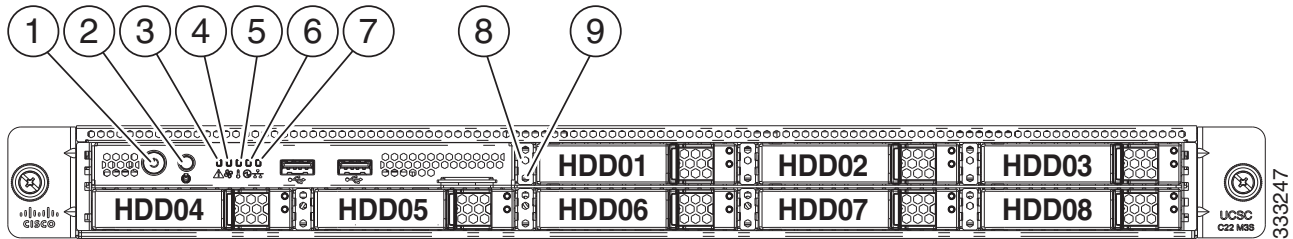

1	Power button/Power status LED	6	Power supply status LED
2	Identification button/LED	7	Network link activity LED
3	System status LED	8	Hard drive fault LED
4	Fan status LED	9	Hard drive activity LED
5	Temperature status LED	—	—

See [Table 31](#) for the functions of the front panel LEDs.

Table 31 Front Panel LEDs

LED	LED State	Meaning
Power (LED is integrated into power button)	Off	Server power is off
	On (amber)	Server power is soft off (power is supplied only to the CIMC and some motherboard functions)
	On (green)	Card power is on
Unit ID (LED is integrated into unit ID button)	Off	Unit ID not active
	On (blue)	Unit ID is activated

Table 31 Front Panel LEDs (*continued*)

LED	LED State	Meaning
System Status	Off	Undefined
	On (green)	Server is in normal operating condition
	On (amber)	Server is in a degraded operational state. For example: <ul style="list-style-type: none"> <li>■ Power supply redundancy is lost.</li> <li>■ CPUs are mismatched.</li> <li>■ At least one CPU is faulty.</li> <li>■ At least one DIMM is faulty.</li> <li>■ At least one drive in a RAID configuration failed.</li> </ul>
	Blinking (amber)	Server is in a critical fault state. For example: <ul style="list-style-type: none"> <li>■ Boot failed.</li> <li>■ Fatal CPU and/or bus error is detected.</li> <li>■ Server is in over-temperature condition</li> </ul>
Fan Status	Off	Undefined
	On (green)	Fans are operating and no error condition has been detected
	On (amber)	Fans are in a degraded operational state, indicating that one of the fans has a fault.
	Blinking (amber)	Critical fault state, indicating that two or more fans have a fault.
Temperature Status	Off	Undefined
	On (green)	System is operating at normal temperature and no error conditions have been detected.
	On (amber)	One or more temperature sensors exceeded a warning threshold.
	Blinking (amber)	One or more temperature sensors exceeded a critical threshold
Power Supply Status	Off	Undefined
	On (green)	AC power supplies are operating and no error condition has been detected.
	On (amber)	One or more power supplies are in a degraded operational state.
	Blinking (amber)	One or more power supplies are in a critical fault state.
Network Link Status	Off	Undefined
	On (green)	Link pulses detected on any of the LOM ports, but no activity.

Table 31 Front Panel LEDs (continued)

LED	LED State	Meaning
	Blinking (green)	Activity on any of the LOM ports
Hard Drive Fault	Off	The hard drive is operating properly
	On (amber)	The hard drive has failed
	Blinking (amber)	The hard drive is rebuilding
Hard Drive Activity	Off	There is no hard drive in the hard drive sled (no access, no fault)
	On (green)	The hard drive is ready
	Blinking (green)	The hard drive is reading or writing data

### Rear Panel

Figure 13 shows the rear panel LEDs.

Figure 13 Rear Panel LEDs

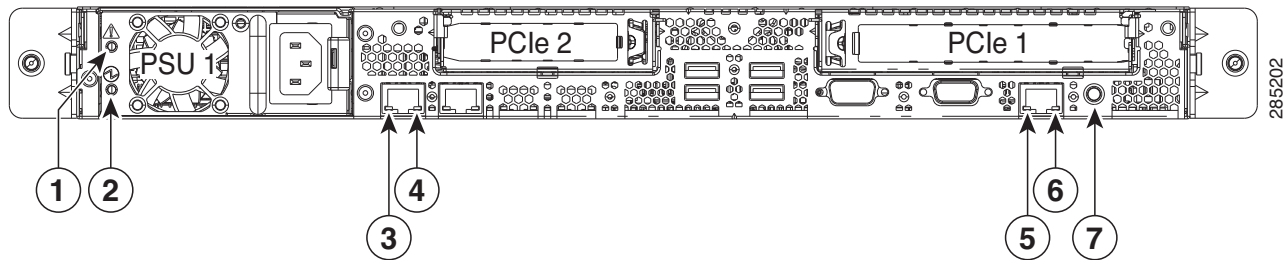

1	Power supply fault LED	5	10/100/1000 Ethernet dedicated management link status LED
2	Power supply AC OK LED	6	10/100/1000 Ethernet dedicated management link speed LED
3	1-Gb Ethernet link speed LED	7	Rear Identification button/LED
4	1-Gb Ethernet link status LED	—	—



See [Table 32](#) for the functions of the rear panel LEDs.

Table 32 Rear Panel LEDs

LED	LED State	Meaning
Power Supply Fault	Off	The power supply is operating normally
	Blinking (amber)	An event warning threshold has been reached, but the power supply continues to operate
	On (amber)	A critical fault threshold has been reached, causing the power supply to shut down (for example, a fan failure or an over-temperature condition).
Power Supply AC	Off	There is no AC power to the power supply
	Blinking (green)	AC power OK, DC output not enabled
	On (green)	AC power OK, DC outputs OK
1GbE Link Speed	Off	Link Speed = 10 Mbps
	On (amber)	Link Speed = 100 Mbps
	On (green)	Link Speed = 1 Gbps
1GbE Link Status	Off	No Link
	On (green)	Link is active
	Blinking (green)	Traffic is present on the active link
10/100/1000 Base-T Link Status	Off	No Link
	On (green)	Link is active
	Blinking (green)	Traffic is present on the active link
10/100/1000 Base-T Link Speed	Off	Link Speed = 10 Mbps
	On (amber)	Link Speed = 100 Mbps
	On (green)	Link Speed = 1 Gbps
Unit ID (LED is integrated into unit ID button)	Off	Unit ID not active
	On (blue)	Unit ID is activated

## TECHNICAL SPECIFICATIONS

### Dimensions and Weight

Table 33 UCS C22 M3 Dimensions and Weight

Parameter	Value
Height	1.70 in (43.2 mm)
Width	16.93 in.(430 mm)
Depth	26.0 in. (660.4 mm)
Front Clearance	3 in. (76 mm)
Side Clearance	1 in. (25 mm)
Rear Clearance	9 in. (233 mm)
Weight	
Maximum (8 HDDs, 2 CPUs, 12 DIMMs, 1 power supply)	27.78 lbs (12.6 kg)
Bare (0 HDD, 0 CPU, 0 DIMM, no power supply)	23.48 lbs (10.65 kg)

### Power Specifications

The general power specifications for the C22 M3 SFF server 450 W power supply are listed in [Table 34](#).

Table 34 UCS C22 M3 SFF 450 W Power Supply Specifications

Description	Specification
AC input voltage	90 to 264 VAC self-ranging 100 to 120 VAC nominal 200 to 240 VAC nominal
AC input frequency	Range: 47 to 63 Hz (single phase, 50 to 60 Hz nominal)
Maximum AC input current	6 A maximum at 100 VAC 3 A maximum at 208 VAC
Maximum AC inrush current	9 A peak @ 35° C, 208 VAC
Maximum output power for the power supply	450 W
Power supply output voltage	Main power: 12 VDC Standby power: 12 VDC
Power supply efficiency	CSCI Platinum



NOTE: AC input connector is an IEC 320 C-14 15A/250VAC power inlet.

The general power specifications for the C22 M3 SFF server 650 W power supply are listed in [Table 34](#).

Table 35 UCS C22 M3 SFF 650 W Power Supply Specifications

Description	Specification
AC input voltage	90 to 264 VAC self-ranging, 100 to 120 VAC nominal 200 to 240 VAC nominal
AC input frequency	Range: 47 to 63 Hz (single phase, 50 to 60 Hz nominal)
Maximum AC input current	7.6 A maximum at 100 VAC 3.65 A maximum at 208 VAC
Maximum AC inrush current	11 A peak @ 35° C, 208 VAC
Maximum output power for the power supply	650 W
Power supply output voltage	Main power: 12 VDC Standby power: 12 VDC
Power supply efficiency	CSCI Platinum



NOTE: AC input connector is an IEC 320 C-14 15A/250VAC power inlet.

For configuration-specific power specifications, use the Cisco UCS Power Calculator at this URL:

<http://ucspowercalc.cisco.com>

## Environmental Specifications

The power specifications for the C22 M3 server are listed in [Table 36](#).

Table 36 UCS C22 M3 Environmental Specifications

Parameter	Minimum
Temperature operating	41 to 95° F (5 to 35° C) Maximum temperature is to be derated by 1 degree C for every 305 m (1000 ft.) of altitude above sea level
Temperature nonoperating	-40 to 149° F (-40 to 65° C)
Humidity (RH) nonoperating, non-condensing	10 to 90%
Altitude operating	0 to 3,000 m (0 to 10,000 ft.)
Altitude nonoperating	0 to 12,192 m (0 to 40,000 ft.)
Sound Power level, Measure A-weighted per ISO7779 LWAd (Bels) Operation at 73° F (23° C)	5.9
Sound Pressure level, Measure A-weighted per ISO7779 LpAm (dBA) Operation at 73° F (23° C)	46

## Compliance Requirements

The regulatory compliance requirements for C-Series servers are listed in [Table 37](#).

Table 37 UCS C-Series Regulatory Compliance Requirements

Parameter	Description
Regulatory Compliance	Products should comply with CE Markings per directives 2004/108/EC and 2006/95/EC
Safety	UL 60950-1 Second Edition CAN/CSA-C22.2 No. 60950-1 Second Edition EN 60950-1 Second Edition IEC 60950-1 Second Edition AS/NZS 60950-1 GB4943 2001
EMC - Emissions	47CFR Part 15 (CFR 47) Class A AS/NZS CISPR22 Class A CISPR22 Class A EN55022 Class A ICES003 Class A VCCI Class A EN61000-3-2 EN61000-3-3 KN22 Class A CNS13438 Class A
EMC - Immunity	EN55024 CISPR24 EN300386 KN24



**Americas Headquarters**  
Cisco Systems, Inc.  
San Jose, CA

**Asia Pacific Headquarters**  
Cisco Systems (USA) Pte. Ltd.  
Singapore

**Europe Headquarters**  
Cisco Systems International BV Amsterdam,  
The Netherlands

Cisco has more than 200 offices worldwide. Addresses, phone numbers, and fax numbers are listed on the Cisco Website at [www.cisco.com/go/offices](http://www.cisco.com/go/offices).

Cisco and the Cisco Logo are trademarks of Cisco Systems, Inc. and/or its affiliates in the U.S. and other countries. A listing of Cisco's trademarks can be found at [www.cisco.com/go/trademarks](http://www.cisco.com/go/trademarks). Third party trademarks mentioned are the property of their respective owners. The use of the word partner does not imply a partnership relationship between Cisco and any other company. (1005R)

